



Digital – in the vehicle

Familiarize yourself with the contents of the Operator's Manual directly via the vehicle's multimedia system (menu item "Vehicle information"). Start with the quick guide or broaden your knowledge with practical tips.



Vehicle document wallet

Here you can find comprehensive information about operating your vehicle and about services and guarantees in printed form.



2235843807

Order no. P223 0273 13 Part no. 223 584 38 07
Edition A-2022

S-Class

Mercedes-Benz



S-Class

Operator's Manual

Mercedes-Benz



Front passenger airbag warning

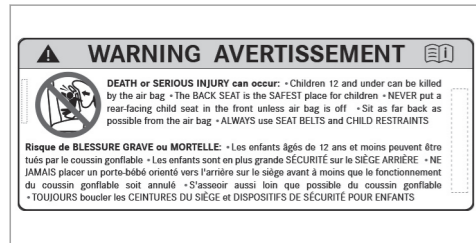
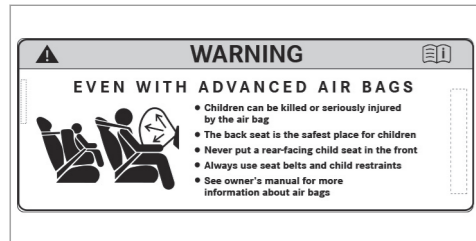

Airbag warning sticker for USA and Canada

WARNING Risk of injury or death if the co-driver airbag is enabled

If the co-driver airbag is enabled, a child on the co-driver seat may be struck by the co-driver airbag during an accident.

NEVER use a rearward-facing child restraint system on a seat with an ENABLED FRONT AIRBAG; DEATH or SERIOUS INJURY to the CHILD can occur.

Observe the chapter "Children in the vehicle".

Publication details

Internet

Further information about Mercedes-Benz vehicles and about Mercedes-Benz AG can be found on the following websites:

<https://www.mbusa.com> (USA only)

<https://www.mercedes-benz.ca> (Canada only)

Documentation team

©Mercedes-Benz AG: Not to be reprinted, translated or otherwise reproduced, in whole or in part, without written permission from Mercedes-Benz AG.

Vehicle manufacturer

Mercedes-Benz AG

Mercedesstraße 120

70372 Stuttgart

Germany

As at 07.10.2020

Thank you for buying Mercedes-Benz

Before you first drive off, read this Operator's Manual carefully and familiarize yourself with your vehicle. For your own safety and a longer operating lifespan of the vehicle, follow the instructions and warning notices in this Operator's Manual. Disregarding them may lead to damage to the vehicle or injury to people.

Damage to the vehicle resulting from the disregard of the instructions is not covered by the Mercedes-Benz Limited Warranty.

The standard equipment and product description of your vehicle may vary and depends on the following factors:

- Model
- Order
- National version
- Availability

Mercedes-Benz reserves the right to introduce changes in the following areas:

- Design
- Equipment

- Technical features

The equipment in your vehicle may therefore differ from that shown in the descriptions and illustrations.

The following documents are integral parts of the vehicle:

- Digital Operator's Manual
- Printed Operator's Manual
- Maintenance Booklet
- Equipment-dependent Supplements

Keep these documents in the vehicle at all times. If you sell the vehicle, always pass all of the documents on to the new owner.

Mercedes-Benz USA, LLC
Mercedes-Benz Canada, Inc.
A Daimler Company

2235843807



Symbols	5	Declaration of conformity for vehicle installed radio components	30	Opening and closing	76
At a glance	6	Diagnostics connection	32	SmartKey	76
Cockpit	6	Qualified specialist workshop	33	Doors	81
Indicator and warning lamps (standard)	8	Correct use of the vehicle	33	Trunk	85
Indicator and warning lamps (with driver camera)	12	Notes for persons with electronic medical aids	34	Side windows	92
Overhead control panel	16	Problems with your vehicle	34	Sliding sunroof	96
Door operating unit and seat adjustment	18	Reporting safety defects	34	Roller sun blinds	101
Control settings in the rear passenger compartment	20	Limited Warranty	35	Anti-theft protection	103
Emergencies and breakdowns	22	QR code for rescue card	35	Seats and stowing	106
Digital Operator's Manual	24	Data storage	36	Notes on the correct driver's seat position	106
Calling up the Digital Operator's Manual	24	Copyright	40	Seats	106
General notes	25	Occupant safety	42	Steering wheel	126
Protection of the environment	25	Restraint system	42	Easy entry and exit feature	128
Genuine Mercedes-Benz parts	25	Seat belts	44	Memory function	129
Operator's Manual	26	Airbags	49	Memory function in the rear passenger compartment	131
Touch-sensitive controls	27	PRE-SAFE® system	60	Stowage areas	134
Service and vehicle operation	27	Automatic measures after an accident	61	Cup holder	145
Operating safety	28	Safely transporting children in the vehicle	62	Sockets	146
		Notes on pets in the vehicle	75	Refrigerator box	148
				Wireless charging of the mobile phone and connection with the exterior antenna ...	151

Installing and removing the floor mats	154	Driving and driving safety systems	218	Maintenance and care	337
		Vehicle towing instructions	279	ASSYST PLUS service interval display	337
Light and visibility	155	Driver display	280	Engine compartment	338
Exterior lighting	155	Notes on the driver display	280	Cleaning and care	343
Interior lighting	165	Notes on the 3D driver display	280	Breakdown assistance	350
Windshield wiper and windshield washer system	168	Operating the driver display	280	Emergency	350
Mirrors	171	Menus on the driver display	281	Flat tire	351
Area permeable to radio waves on the windshield	174	Head-up Display	282	Battery (vehicle)	357
Infrared-reflective windshield function	175	Vehicles with a 48 V on-board electrical system (EQ Boost technology)	285	Tow starting or towing away	363
Climate control	176	Overview of status displays on the driver display	286	Electrical fuses	369
Overview of climate control systems	176	MBUX multimedia system	287	Wheels and tires	373
Operating the climate control system	178	Overview and operation	287	Notes on noise or unusual handling char- acteristics	373
Driving and parking	189	System settings	302	Notes on regularly inspecting wheels and tires	373
Driving	189	Navigation and traffic	307	Notes on snow chains	374
DYNAMIC SELECT button	201	Telephone	316	Activating or deactivating snow chain mode	374
Automatic transmission	203	Mercedes me and apps	319	Tire pressure	375
Function of the 4MATIC	207	Mercedes-Benz emergency call system	326	Loading the vehicle	380
Refueling	208	Radio & media	329	Tire labeling	384
Parking	210	Sound settings	336	Definition of terms for tires and loading	389

4 Contents

Changing a wheel	392
Emergency spare wheel	401

Technical data	402
Notes on technical data	402
Vehicle electronics	402
Regulatory radio identification of small components	404
Vehicle identification plate, VIN and engine number overview	492
Operating fluids	494
Vehicle data	501

Display messages and warning/indi- cator lamps	503
Display messages	503
Warning and indicator lamps	561

Index	579
--------------------	------------

In this Operator's Manual, you will find the following symbols:

⚠ DANGER Danger due to not observing the warning notices

Warning notices draw your attention to hazards that may endanger your health or life, or the health or life of others.

▶ Observe the warning notices.

🌿 ENVIRONMENTAL NOTE Environmental damage due to failure to observe environmental notes

Environmental notes include information on environmentally responsible behavior or environmentally responsible disposal.

▶ Observe environmental notes.

! NOTE Damage to property due to failure to observe notes on material damage

Notes on material damage inform you of risks which may lead to your vehicle being damaged.

▶ Observe notes on material damage.

ⓘ These symbols indicate useful instructions or further information that could be helpful to you.

▶ Instruction

(→ page) Further information on a topic

Display Messages in the central display







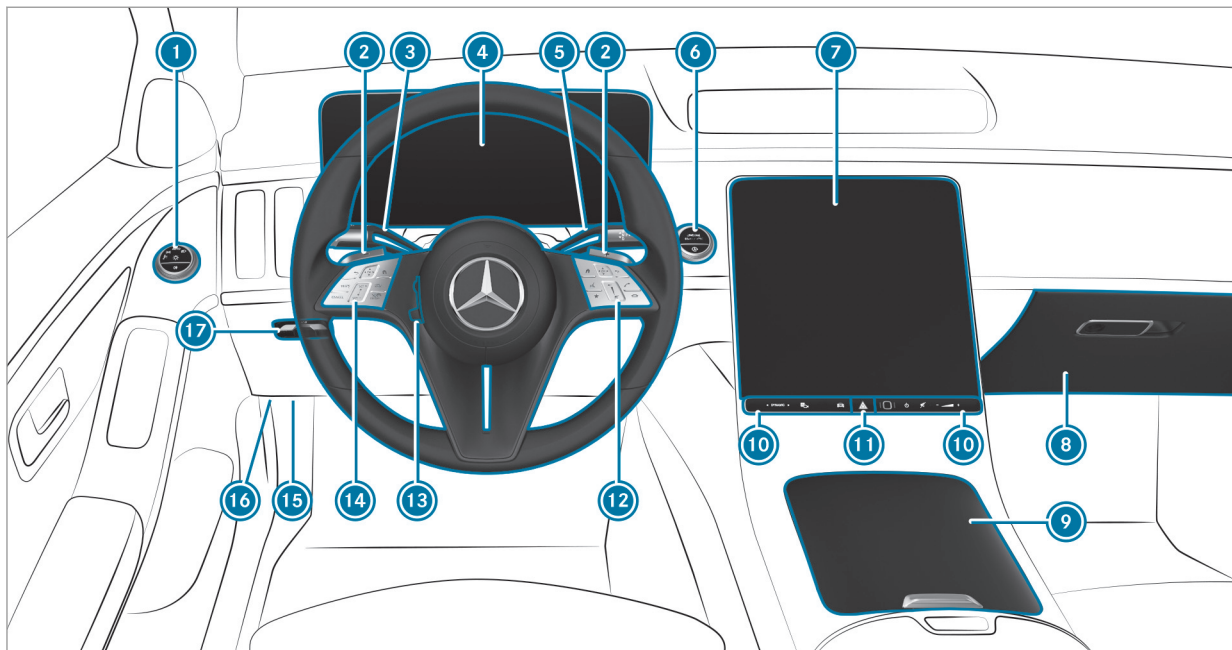







↪ Highest menu level, which is to be selected in the multimedia system

▶▶ Relevant submenus, which are to be selected in the multimedia system

* Indicates a cause









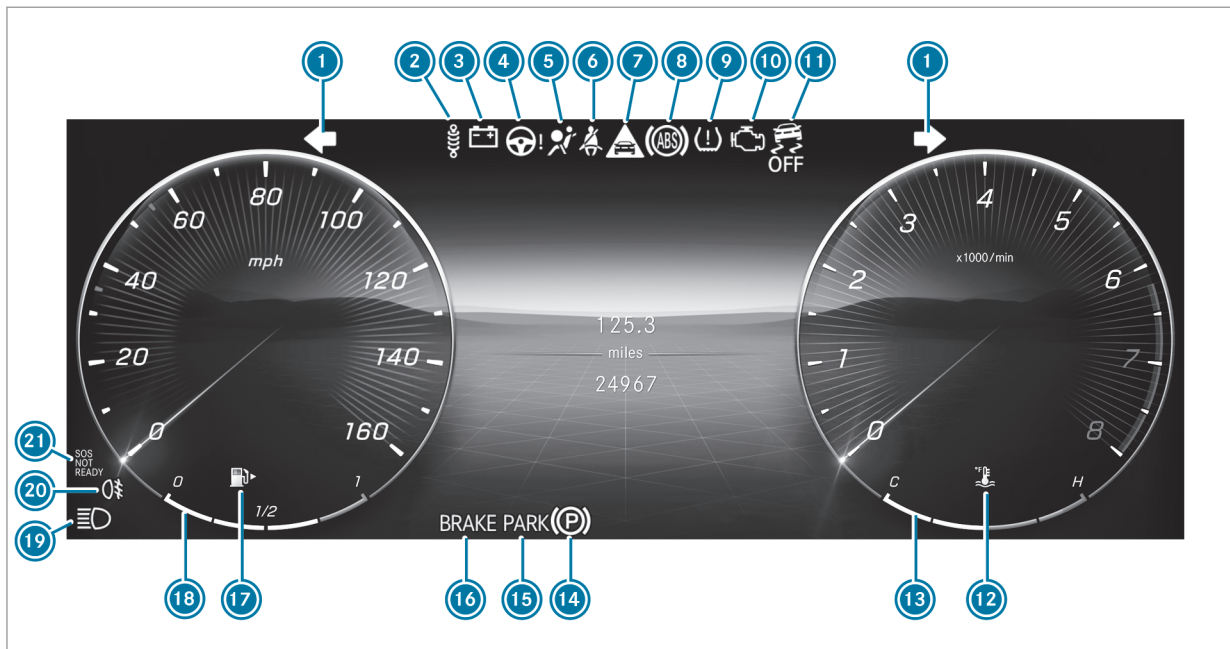





















Left-hand-drive vehicles

1	Light switch	→	155		Switches the MBUX multimedia system on/off	→	287	
2	Steering wheel gearshift paddles	→	206		Switches sound on/off	→	287	
3	Combination switch	→	156		Adjusts the volume	→	287	
4	Driver display	→	280	11 	Hazard warning light system	→	157	
5	DIRECT SELECT lever	→	203	12	Control panel for the MBUX multimedia system	→	289	
6	 Start/stop button	→	190	13	Adjusts the steering wheel	→	126	
	 ECO start/stop function	→	199		Switches the steering wheel heater on/off	→	127	
7	Central display	→	287	14	Control panel: Driver display	→	280	
8	Glove box	→	137		Active Distance Assist DISTRONIC	→	228	
9	Storage compartment	→	137	15	Diagnostics connection	→	32	
10	Switch panel for:			16		Opens the hood	→	338
	 DYNAMIC SELECT button	→	202	17		Electric parking brake	→	214
	 Active Parking Assist	→	273					
	 Quick vehicle access							
	 Fingerprint sensor	→	287					

8 At a glance – Indicator and warning lamps (standard)



Driver display (standard)

1		Turn signal lights	→	156	12		Coolant temperature	→	566
2		Suspension (red)	→	573	13		Coolant temperature display		
		Suspension (yellow)	→	573	14		Electric parking brake (yellow)	→	570
3		Electrical malfunction	→	566	15		Electric parking brake (red)	→	570
4		Power steering (red)	→	564			USA only		
		Power steering (yellow)	→	564			Canada only		
		Rear axle steering (red)	→	564	16		Brakes (red)	→	570
		Rear axle steering (yellow)	→	564			USA only		
5		Restraint system	→	562			Canada only		
6		Seat belt	→	562			Recuperative Brake System, USA only	→	570
7		Distance warning	→	573			Brakes (yellow), Canada only	→	570
8		ABS	→	574	17		Reserve fuel with fuel filler flap location indicator	→	566
9		Tire pressure monitoring system	→	577	18		Fuel level		
10		Check Engine	→	566	19		High beam	→	156
11		ESP® OFF	→	574			Low beam	→	155
		ESP®	→	574			Parking lights	→	155

10 At a glance – Indicator and warning lamps (standard)

20  Rear fog light



156

21 

Mercedes-Benz emergency call system









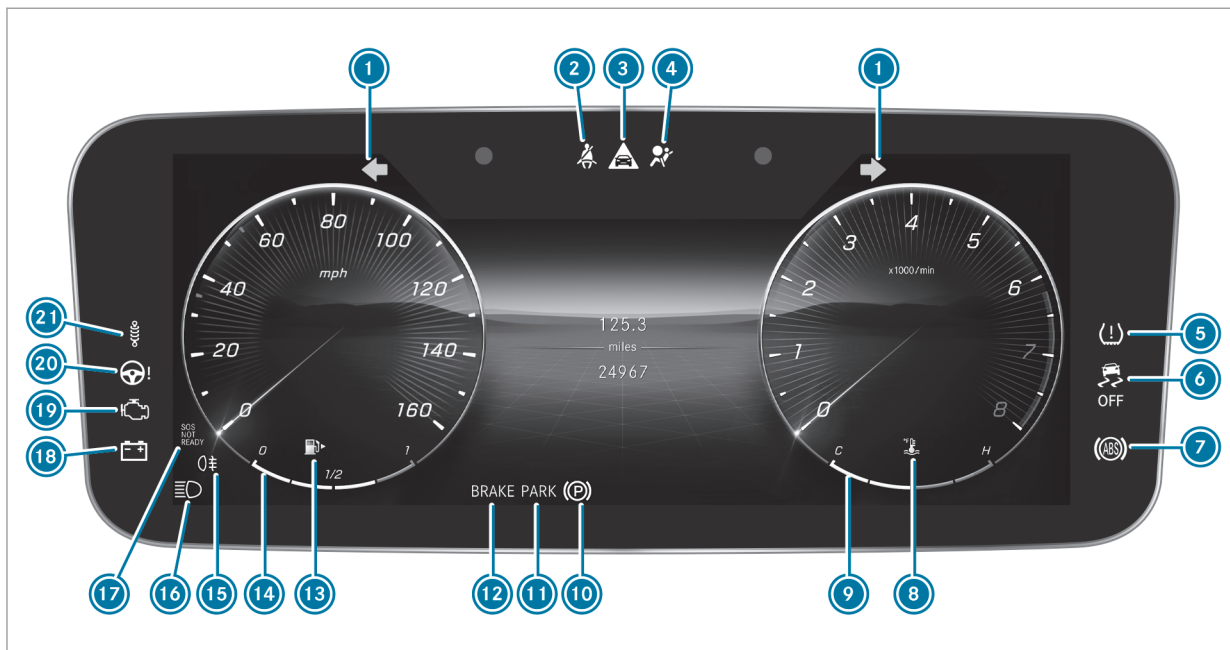





















577



12 At a glance – Indicator and warning lamps (with driver camera)



Driver display with driver camera

①	 	Turn signal lights	→	156			
②		Seat belt	→	562			
③		Distance warning	→	573			
④		Restraint system	→	562			
⑤		Tire pressure monitoring system	→	577			
⑥		ESP® OFF	→	574			
		ESP®	→	574			
⑦		ABS	→	574			
⑧		Coolant temperature	→	566			
⑨		Coolant temperature display					
⑩		Electric parking brake (yellow)	→	570			
⑪		Electric parking brake (red)	→	570			
		USA only					
		Canada only					
⑫		Brakes (red)	→	570			
		USA only					
		Canada only					
		Recuperative Brake System, USA only	→	570			
		Brakes (yellow), Canada only	→	570			
⑬		Reserve fuel with fuel filler flap location indicator	→	566			
⑭		Fuel level					
⑮		Rear fog light	→	156			
⑯		High beam	→	156			
		Low beam	→	155			
		Parking lights	→	155			
⑰		Mercedes-Benz emergency call system	→	577			
⑱		Electrical malfunction	→	566			
⑲		Check Engine	→	566			
⑳		Power steering (red)	→	564			
		Power steering (yellow)	→	564			
		Rear axle steering (red)	→	564			
		Rear axle steering (yellow)	→	564			

14 At a glance – Indicator and warning lamps (with driver camera)

21



Suspension (red)



573



Suspension (yellow)









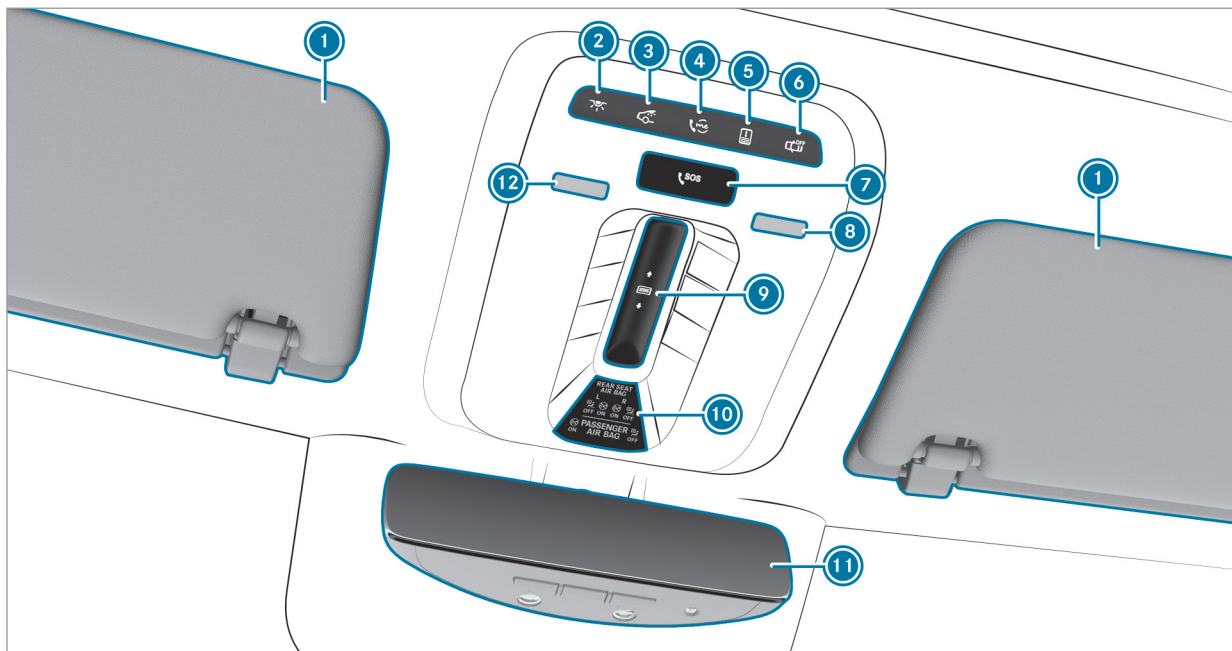

573











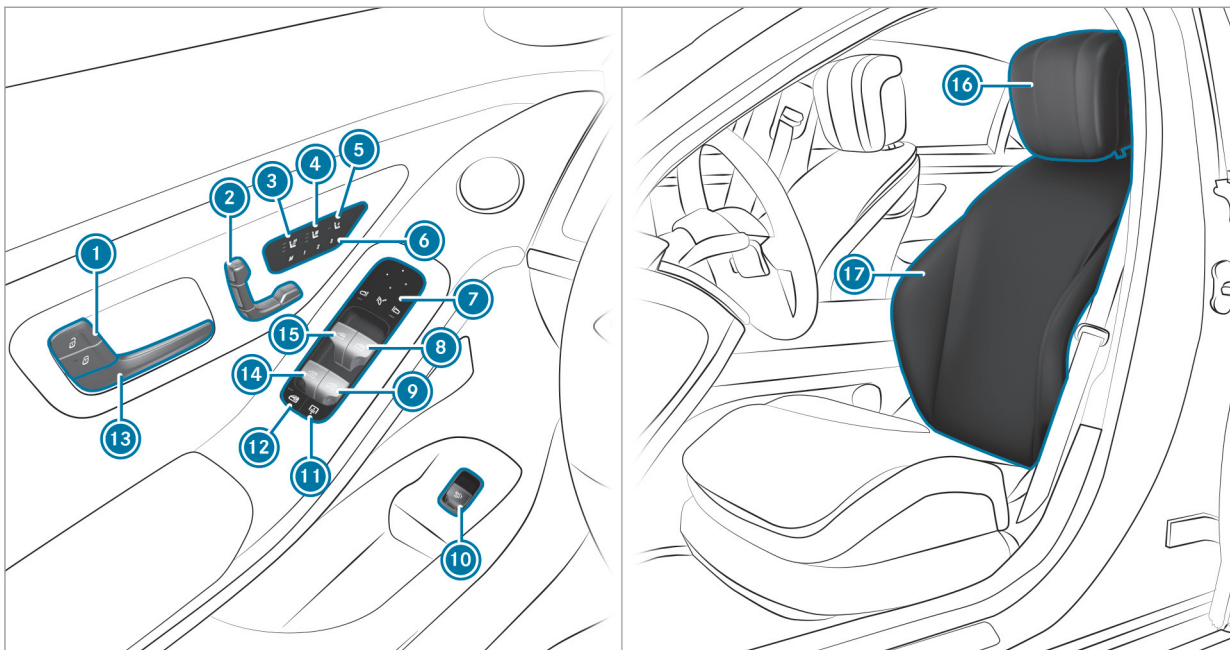

16 At a glance – Overhead control panel







1	Sun visors		
2	 Switches the front interior lighting on/off	→	165
3	 Switches the rear interior lighting on/off	→	165
4	 me button	→	321
5	 Opens/closes the rear roller sunblind for the panorama roof with power tilt/sliding panel	→	96
6	 Switches automatic interior lighting control on/off	→	165
7	 SOS button	→	321
8	Switches the right-hand reading lamp on/off	→	165
9	 Opens/closes the panorama roof with power tilt/sliding panel	→	96
	 Opens/closes the front roller sunblind for the panorama roof with power tilt/sliding panel	→	96
10	Indicator lamps:		
	PASSENGER AIR BAG	→	55
	REAR SEAT AIRBAG	→	59
11	Inside rearview mirror	→	173
12	Switches the left-hand reading lamp on/off	→	165

18 At a glance – Door operating unit and seat adjustment







①	 	Locks/unlocks the vehicle	→	81
②		Adjusts the seats electrically	→	106
③		Switches the seat heating on/off	→	124
④		Switches the seat ventilation on/off	→	126
⑤		Adjusts the front passenger seat from the driver's seat	→	109
⑥		Operates the memory function	→	130
⑦		Operates the outside mirrors	→	171
⑧		Opens/closes the right side window	→	92
⑨		Opens/closes the rear right side window	→	92

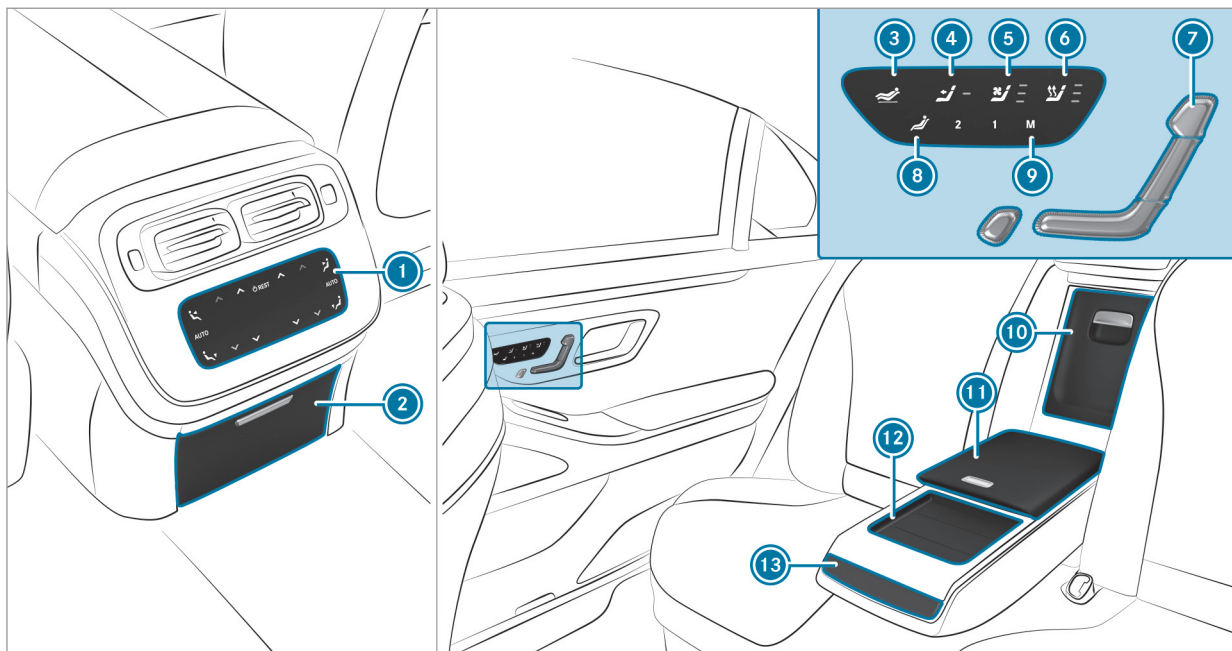

⑩		Opens/closes the trunk lid	→	85
⑪		Rear window roller sunblind	→	101
⑫		Child safety lock for the rear side windows	→	75
⑬		Opens the door	→	81
⑭		Opens/closes the rear left side window	→	92
⑮		Opens/closes the left side window	→	92
⑯		Adjusts the head restraints	→	118
⑰		Seat adjustment using the multimedia system	→	122

20 At a glance – Control settings in the rear passenger compartment





Vehicles with a reclining rear seat

①	Climate control rear operating unit	→	177
②	Electronics compartment in the center console		
	115 V socket	→	147
③	 Sets the fully reclined position	→	113
④	 Selects the front passenger seat	→	110
⑤	 Switches the rear seat ventilation on/off	→	126
⑥	 Switches the rear seat heating on/off	→	124
⑦	Adjusts reclining rear seats electrically	→	112

⑧	 Resets the standard seat adjustment settings	→	113
⑨	 Memory function in the rear passenger compartment	→	132
⑩	Storage box in the seat backrest		
	Refrigerator box	→	148
⑪	Storage compartment in the rear armrest		
⑫	MBUX rear tablet bracket		
⑬	Cup holder		

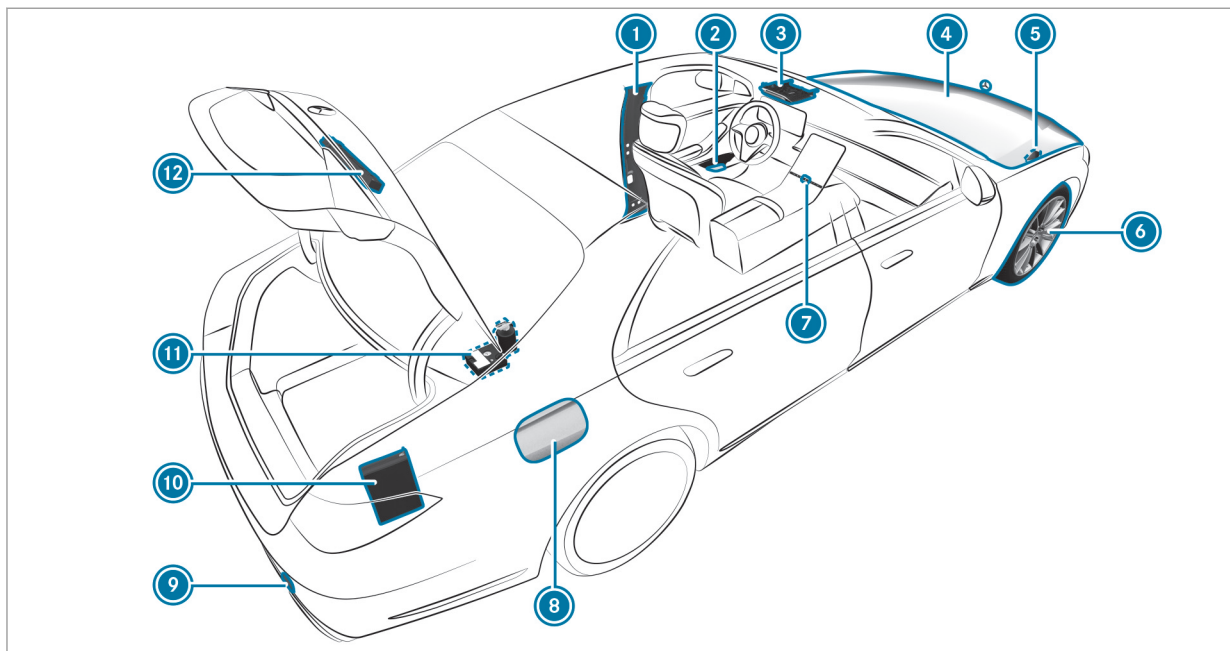
22 At a glance – Emergencies and breakdowns



① B-pillar with:		
QR code for accessing the rescue card	→	35
② Safety vests	→	350
③  MIC button	→	321
 SOS button	→	321
④ Checking and refilling operating fluids	→	494
Starting assistance	→	361
⑤ Tow-starting or towing away	→	364
⑥ Flat tire	→	351

⑦  Hazard warning light system	→	157
⑧ Fuel filler flap with:		
information label on fuel type	→	208
Information label on tire pressure	→	376
QR code for accessing the rescue card	→	35
⑨ Tow-starting or towing away	→	364
⑩ First-aid kit (soft sided)	→	351
⑪ TIREFIT kit	→	353
⑫ Warning triangle	→	351

Calling up the Digital Operator's Manual

Multimedia system:

-  » Settings » Info
- » Operator's Manual
- » Open Digital Operator's Manual

The Digital Operator's Manual describes the functions and operation of the vehicle and the multimedia system.

- ▶ Select one of the following menu items in the Digital Operator's Manual:
 - **Quick start:** find the first steps towards setting up your vehicle.
 - **Tips:** find information that prepares you for certain everyday situations with your vehicle.
 - **Animations:** watch animations of the vehicle functions.
 - **Messages:** receive additional information about the messages in the driver display.
 - **Language:** select the language for the Digital Operator's Manual.

You can search for keywords using the search field **Search**, in order to find quick answers to questions about the operation of the vehicle.

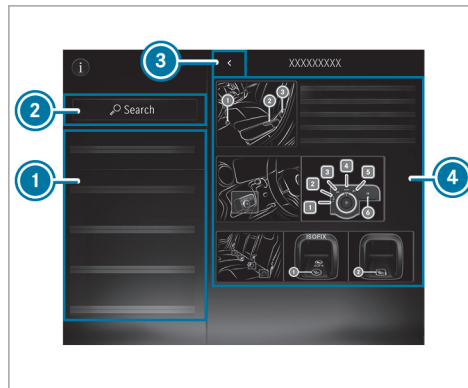

- ① Menu
- ② Search
- ③ Back
- ④ Contents section

Some sections in the Digital Operator's Manual, such as warning notes, can be expanded and collapsed.

Additional methods of calling up the Digital Operator's Manual:

Driver display: call up brief information as display messages in the instrument cluster

MBUX Voice Assistant: call up via the voice control system

Global search: call up search results for contents of the Digital Operator's Manual in the home screen

For safety reasons, the Digital Operator's Manual is deactivated while driving.

Protection of the environment

 **ENVIRONMENTAL NOTE** Environmental damage due to operating conditions and personal driving style

The pollutant emission of the vehicle is directly related to the way you operate the vehicle.

Operate your vehicle in an environmentally responsible manner to help protect the environment. Please observe the following recommendations on operating conditions and personal driving style.

Operating conditions:

- ▶ Make sure that the tire pressure is correct.
- ▶ Do not carry any unnecessary weight (e.g. roof luggage racks once you no longer need them).
- ▶ Adhere to the service intervals. A regularly serviced vehicle will contribute to environmental protection.

- ▶ Always have maintenance work carried out at a qualified specialist workshop.

Personal driving style:

- ▶ Do not depress the accelerator pedal when starting the engine.
- ▶ Do not warm up the engine while the vehicle is stationary.
- ▶ Drive carefully and maintain a suitable distance from the vehicle in front.
- ▶ Avoid frequent, sudden acceleration and braking.
- ▶ Change gear in good time and use each gear only up to $\frac{2}{3}$ of its maximum engine speed.
- ▶ Switch off the engine in stationary traffic, e.g. by using the ECO start/stop function.
- ▶ Drive in a fuel-efficient manner. Observe the ECO display for an economical driving style.

Environmental issues and recommendations

It is recommended that you re-use or recycle materials instead of just disposing of them.

The relevant environmental guidelines and regulations serve to protect the environment and must be strictly observed.

Genuine Mercedes-Benz parts

 **ENVIRONMENTAL NOTE** Environmental damage due to not using recycled reconditioned components

Mercedes-Benz AG offers recycled reconditioned components and parts with the same quality as new parts. The same entitlement from the Limited Warranty is valid as for new parts.

- ▶ Use recycled reconditioned components and parts from Mercedes-Benz AG.

! **NOTE** Impairment of the operating efficiency of the restraint systems from installing accessory parts or from repairs or welding

Airbags and Emergency Tensioning Devices, as well as control units and sensors for the restraint systems, may be installed in the following areas of your vehicle:

- Doors
- Door pillars
- Door sills
- Seats
- Cockpit
- Instrument cluster
- Center console
- Lateral roof frame

- ▶ Do not install accessory parts such as audio systems in these areas.
- ▶ Do not carry out repairs or welding.
- ▶ Have accessory parts retrofitted at a qualified specialist workshop.

You could jeopardize the operating safety of your vehicle if you use parts, tires and wheels as well as accessories relevant to safety which have not been approved by Mercedes-Benz. Safety-relevant systems, e.g. the brake system, may malfunction. Only use genuine Mercedes-Benz parts or parts of equal quality. Only use tires, wheels and accessory parts that have been specifically approved for your vehicle model.

Genuine Mercedes-Benz parts are subject to strict quality inspections. Each part has been specially developed, manufactured or selected for Mercedes-Benz vehicles and adapted to them. Therefore, only genuine Mercedes-Benz parts should be used.

More than 300,000 different genuine Mercedes-Benz parts are available for Mercedes-Benz models.

All authorized Mercedes-Benz Centers maintain a supply of genuine Mercedes-Benz parts for necessary service and repair work. In addition, strategically located parts delivery centers provide for quick and reliable parts service.

Always specify the vehicle identification number (VIN) (→ page 492) when ordering genuine Mercedes-Benz parts.

Operator's Manual

This Operator's Manual describes all models and all standard and optional equipment available for your vehicle at the time of this Operator's Manual going to press. Country-specific differences are possible. Note that your vehicle may not be equipped with all features described. This is also the case for systems and functions relevant to safety. Therefore, the equipment on your vehicle may differ from that in the descriptions and illustrations.

The original purchase agreement for your vehicle contains a list of all of the systems in your vehicle.

Should you have any questions concerning equipment and operation, please consult an authorized Mercedes-Benz Center.

The Operator's Manual and Maintenance Booklet are important documents and should be kept in the vehicle.

Touch-sensitive controls

In addition to conventional switches and buttons, your vehicle is equipped with touch-sensitive controls.

These are located in the following areas of your vehicle:

- Roof and door control panel
- Climate control
- Steering wheel
- MBUX multimedia system

The controls have touch-sensitive user interface surfaces. The surfaces are controlled by pressing or swiping to adjust settings or to trigger functions, for example.

In the area of the touchscreen, you also receive haptic feedback in the form of a pulse or a vibration, or the surface structure changes on the touch-sensitive user interface surface, for example.

You receive haptic feedback in the following situations, for example:

- When pressing a button on the user interface surface
- When scrolling in a list or table
- When reaching a new area on the user interface surface, e.g. a pop-up window

When handling touch-sensitive user interface surfaces, observe the following points to avoid problems operating:

- Do not affix stickers or similar objects on the surfaces
- Keep the surfaces protected from moisture and wet conditions
- Keep the surfaces free of dust and dirt

Some touch-sensitive control elements have a symbol and integrated indicator lamps. When operating, make sure to press on the symbol of the control element.

Service and vehicle operation

Vehicle operation outside the USA or Canada

When you are abroad with your vehicle, observe the following points:

- Service points or replacement parts may not be available immediately.
- Unleaded fuel may not be available for vehicles with a catalytic converter. Leaded fuel may cause damage to the catalytic converter.
- The fuel may have an extremely low octane number. Unsuitable fuel can cause engine damage.

Some Mercedes-Benz models are available in Europe through our European Delivery Program. For more information, please consult an authorized Mercedes-Benz service center, or write to one of the following address:

In the USA:

Mercedes-Benz USA, LLC
European Delivery Department
One Mercedes-Benz Drive
Sandy Springs, GA 30328

In Canada:

Mercedes-Benz Canada, Inc.
European Delivery Department
98 Vanderhoof Avenue
Toronto, Ontario M4G 4C9

Maintenance

Your customer advisor confirms the service in the service report.

Roadside Assistance

The Mercedes-Benz Roadside Assistance Program offers technical help in the case of a breakdown. Your calls to the toll-free Roadside Assistance Hotline are answered by our agents 24 hours a day, 365 days a year.

1-800-FOR-MERCEdes (1-800-367-6372) (USA)
1-800-387-0100 (Canada)

You can find further information in the Mercedes-Benz Roadside Assistance Program brochure (USA) or the "Roadside Assistance"

section in the Service and Warranty booklet (Canada). You will find both in the vehicle document wallet.

Change of address or change of ownership

In the event of a change of address, please send us the "Notification of address change" in the Service and Guarantee booklet or simply call the Mercedes-Benz Customer Assistance Center (USA) on the hotline number 1-800-FOR-MERCEdes (1-800-367-6372) or Customer Service (Canada) on 1-800-387-0100. We can then reach you in a timely fashion, if necessary.

If you sell your Mercedes, please leave all literature in the vehicle so that it is available to the next owner. If you have purchased a used vehicle, please send us the "Notice of Purchase of Used Car" in the Service and Guarantee booklet or simply call the Mercedes-Benz Customer Assistance Center (USA) at the hotline number 1-800-FOR-MERCEdes (1-800-367-6372) or Customer Service (Canada) at 1-800-387-0100.

Possible danger due to substances hazardous to health

In compliance with Proposition 65 ("Prop65"), the following detachable label has been added to each vehicle sold in California:



Operating safety

▲ WARNING Risk of accident due to malfunctions or system failures

To avoid malfunctions or system failures:

- ▶ Always have the prescribed service and maintenance work as well any required

repairs carried out at a qualified specialist workshop.

⚠ WARNING Risk of accident or injury due to incorrect modifications on electronic component parts

Modification of electronic components, their software or wiring could impair their function and/or the function of other networked component parts or safety-relevant systems.

This can endanger the operating safety of the vehicle.

- ▶ Never tamper with the wiring and electronic component parts or their software.
- ▶ You should have all work on electrical and electronic components carried out at a qualified specialist workshop.

Observe the "On-board electronics" section in "Technical data".

⚠ WARNING Risk of fire due to flammable materials on hot parts of the exhaust system

Flammable material such as leaves, grass or twigs may ignite if they come into contact with hot parts of the exhaust system.

- ▶ When driving on unpaved roads or off-road, regularly check the vehicle underside.
- ▶ Remove trapped plants or other flammable material, in particular.
- ▶ If there is damage, consult a qualified specialist workshop immediately.

! NOTE Damage to the vehicle due to driving too fast and due to impacts to the vehicle underbody or suspension components

In the following situations, in particular, there is a risk of damage to the vehicle:

- The vehicle becomes grounded, e.g. on a high curb or an unpaved road
- The vehicle is driven too fast over an obstacle, e.g. a curb, speed bump or pothole
- A heavy object strikes the underbody or suspension components

In situations such as these, damage to the body, underbody, suspension components, wheels or tires may not be visible. Components damaged in this way can unexpectedly fail or, in the case of an accident, may no longer absorb the resulting force as intended.

If the underbody paneling is damaged, flammable materials such as leaves, grass or twigs can collect between the underbody and

the underbody paneling. These materials may ignite if they come into contact with hot parts of the exhaust system.

- ▶ Have the vehicle checked and repaired immediately at a qualified specialist workshop.

or

- ▶ If driving safety is impaired while continuing your journey, pull over and stop the vehicle immediately, while paying attention to road and traffic conditions, and contact a qualified specialist workshop.

Vehicles with a 48 V on-board electrical system (EQ Boost technology)

⚠ DANGER Risk of fatal injury by touching damaged high-voltage components

Vehicles with a 48 V on-board electrical system contain individual high-voltage components. These high-voltage components are under high voltage.

If you modify component parts of these high-voltage components or touch damaged component parts, you may be electrocuted.

High voltage components may be damaged in an accident, although the damage may not be visible.

- ▶ Never perform modifications to component parts of high-voltage components.
- ▶ Never touch damaged component parts of high-voltage components.
- ▶ Never touch component parts of high-voltage components after an accident.

Vehicles with a 48 V on-board electrical system contain high voltage components. These components are marked with a high voltage label:

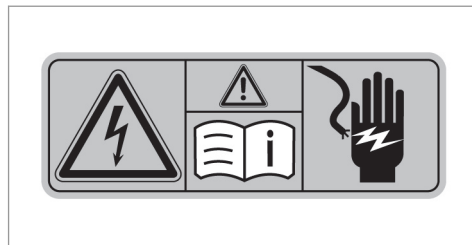

All work on high voltage components must be carried out at a qualified specialist workshop.

Declaration of conformity for vehicle installed radio components

USA: "Radio based devices of this vehicle comply with Part 15 of the FCC Rules. Operation is subject to the following two conditions: 1) These devices may not cause harmful interference, and 2) These devices must accept any interference received, including interference that may cause undesired operation. Changes or modifications not expressly approved by the party responsible

for compliance could void the user's authority to operate the equipment."

Canada: "This vehicle contains license-exempt transmitter(s)/receiver(s) that comply with Innovation, Science and Economic Development Canada's RSS(s). Operation is subject to the following two conditions: (1) These devices may not cause interference, and (2) These devices must accept any interference, including interference that may cause undesired operation of the device."

Charging unit for wireless charging of mobile devices (WMI)

This equipment complies with FCC and IC radiation exposure limits set forth for an uncontrolled environment. This equipment should be installed and operated with a minimum distance of **0 cm (in contact)** between the radiator and your body. This transmitter must not be co-located or operating with any other antenna or transmitter.

USA: "Wireless charging system for mobile devices (Model: D-WMI2015A): This Device complies with Part 18 of the FCC Rules."

The name and address of the party responsible is:

Continental Automotive Systems US Inc.
2400 Executive Hills Drive
Auburn Hills, MI 48326-2980
United States of America

Toll gate antenna (UAGTMB)

This device complies with FCC rules part 90 and Innovation, Science, and Economic Development Canada RSS-137. Operation is subject to the following two conditions: (1) This device may not cause harmful interference, and (2) This device must accept any interference that may be received including interference that may cause undesired operation. **WARNING:** The transmitter has been tested and complies with FCC and ISED rules. Changes or modifications not expressly approved by the party responsible for compliance could void the user's authority to operate the device. This equipment complies with FCC and ISED radiation exposure limits set forth for an uncontrolled environment. End users must follow the specific operating instructions for satisfying RF exposure compliance. This

transmitter must be at least 20 cm from the user and must not be co-located or operating in conjunction with any other antenna or transmitter.

FCC (États-Unis) et ISED (Canada): Cet appareil est conforme aux règlements de la FCC, section 90, et au CNR-137 d'Innovation, Sciences et Développement économique Canada. Le fonctionnement est assujéti aux deux conditions suivantes: (1) cet appareil ne doit pas causer d'interférences nuisibles et (2) cet appareil doit accepter toute interférence reçue, y compris celle qui pourrait entraîner un dysfonctionnement. **MISE EN GARDE:** L'émetteur a subi des tests et est conforme aux règlements de la FCC et d'ISDE. Les changements ou modifications non approuvés explicitement par la partie responsable de la conformité pourraient rendre caduque l'autorisation de l'utilisateur de se servir du dispositif. Cet appareil est conforme aux limites d'exposition aux radiations de la FCC et d'ISDE établies pour un environnement non contrôlé. Les utilisateurs finaux doivent respecter les instructions d'utilisation spécifiques pour satisfaire aux exigences de conformité aux expositions de RF. L'émetteur doit se trouver à 20 cm

au minimum de l'utilisateur et ne doit pas être situé au même endroit que tout autre émetteur ou antenne ni fonctionner avec un autre émetteur ou antenne.

Name and address of the manufacturer

Gentex Corporation
600 North Centennial St.
Zeeland, MI 49464 USA

Diagnostics connection

The diagnostics connection is a technical interface in the vehicle. It is used, for example, within the scope of repair and maintenance work or for reading out vehicle data by a specialist workshop. Diagnostic devices should therefore only be connected by a qualified specialist workshop.

⚠ WARNING Risk of accident due to connecting devices to the diagnostics connection

If you connect devices to the diagnostics connection of the vehicle, the function of

vehicle systems and operating safety may be impaired.

- ▶ For safety reasons, we recommend that you only use and connect products approved by your authorized Mercedes-Benz Center.

⚠ WARNING Risk of accident due to objects in the driver's footwell

Objects in the driver's footwell may impede pedal travel or block a depressed pedal. This jeopardizes the operating and road safety of the vehicle.

- ▶ Stow all objects in the vehicle securely so that they cannot get into the driver's footwell.
- ▶ Always install the floor mats securely and as prescribed in order to ensure that there is always sufficient room for the pedals.
- ▶ Do not use loose floor mats and do not place floor mats on top of one another.

! NOTE Battery discharging from using devices connected to the diagnostics connection

Using devices at the diagnostics connection drains the battery.

- ▶ Check the charge level of the battery.
- ▶ If the charge level is low, charge the battery, e.g. by driving a considerable distance.

Please also note the information about the 12 V battery and short-distance trips in the "Driving and Parking" chapter (→ page 194).

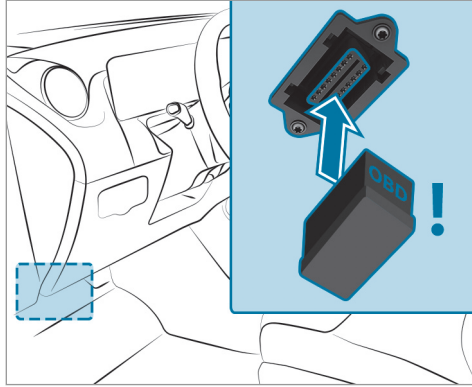

Connecting and using another device with the diagnostics connection can have the following effects:

- Malfunctions in the vehicle system
- Permanent damage to vehicle components

Please refer to the warranty terms and conditions for this matter.

Moreover, connecting equipment to the diagnostics connection can lead to emissions monitoring information being reset, for example. This may lead to the vehicle failing to meet the requirements of the next emissions inspection during the main inspection.

Qualified specialist workshop

An authorized Mercedes-Benz Center is a qualified specialist workshop. It has the necessary special skills, tools and qualifications to correctly carry out the work required on your vehicle. This particularly applies to safety-relevant works.

Always have the following work carried out on your vehicle at a qualified specialist workshop:

- Safety-relevant works
- Service and maintenance work
- Repair work
- Modifications as well as installations and conversions
- Work on electronic components

- **Vehicles with 48 V on-board electrical system (EQ boost technology):** work on high voltage components of the 48 V on-board electrical system

Mercedes-Benz recommends an authorized Mercedes-Benz Center.

Correct use of the vehicle

If you remove any warning stickers, you or others could fail to recognize certain dangers. Leave warning stickers in position.

Observe the following information in particular when driving your vehicle:

- The safety notes in this manual and respective Supplements
- Technical data for the vehicle
- Traffic rules and regulations
- Laws and safety standards pertaining to motor vehicles

Notes for persons with electronic medical aids

Mercedes-Benz AG cannot, despite carefully developing vehicle systems, completely rule out the interaction of vehicle systems with electronic medical aids such as cardiac pacemakers.

In addition, there are components installed in the vehicle that, regardless of the operating status of the vehicle, can generate magnetic fields on a par with permanent magnets. These fields can be found, for example, in the area around the multimedia and sound system or also in the area of the seats, depending on the vehicle equipment.

For this reason, the following can occur in isolated cases, depending on the aids used:

- Medical aids malfunctioning
- Adverse health effects

Observe the notes and warnings of the manufacturer of the medical aids; if in doubt, contact the device manufacturer and/or your doctor. If there is continuing uncertainty concerning the possibility of medical aids malfunctioning, Mercedes-

Benz AG recommends using only few electrical vehicle systems and/or maintaining a distance from the components.

Only have repairs and maintenance work in the area of the following components carried out by a qualified specialist workshop:

- Vehicle components carrying live voltage
- Transmission antenna
- Multimedia system and sound system

If you have any queries or suggestions, consult a qualified specialist workshop.

Problems with your vehicle

If you should experience a problem with your vehicle, particularly one that you believe may affect its safe operation, we urge you to contact an authorized Mercedes-Benz Center immediately to have the problem diagnosed and rectified. If the problem is not resolved to your satisfaction, please discuss the problem again with an authorized Mercedes-Benz Center or, if necessary, contact us at one of the following addresses:

In the USA:

Mercedes-Benz USA, LLC
Customer Assistance Center
One Mercedes-Benz Drive
Sandy Springs, GA 30328

In Canada:

Mercedes-Benz Canada, Inc.
Customer Relations Department
98 Vanderhoof Avenue
Toronto, Ontario M4G 4C9

Reporting safety defects

USA only:

The following text is published as required of manufacturers under Title 49, Code of U.S. Federal Regulations, Part 575 pursuant to the "National Traffic and Motor Vehicle Safety Act of 1966".

If you believe that your vehicle has a defect which could cause a crash or could cause injury or death, you should immediately inform the

National Highway Traffic Safety Administration (NHTSA) in addition to notifying Mercedes-Benz USA, LLC.

If NHTSA receives similar complaints, it may open an investigation, and if it finds that a safety defect exists in a group of vehicles, it may order a recall and remedy campaign. However, NHTSA cannot become involved in individual problems between you, your dealer, or Mercedes-Benz USA, LLC.

To contact NHTSA, you may call the Vehicle Safety Hotline toll-free at 1-888-327-4236 (TTY: 1-800-424-9153); go to the <https://www.safercar.gov/>; or write to: Administrator, NHTSA, 400 Seventh Street, SW., Washington, DC 20590, USA.

You can also obtain other information about motor vehicle safety from: <https://www.safercar.gov>

Canada only:

The following text is published as required of manufacturers under subsection 18.4 (4) of the Motor Vehicle Safety Regulations.

If you believe that your vehicle has a defect which could cause a crash or could cause injury or death, you should immediately inform Transport Canada in addition to notifying Mercedes-Benz Canada Inc.

If Transport Canada received similar complaints, it may open an investigation, and if it finds that a safety defect exists in a group of vehicles, it may order a recall and remedy campaign. However, Transport Canada cannot become involved in individual problems between you, your dealer or Mercedes-Benz Canada Inc.

To contact Transport Canada, you may call the Defect Investigations and Recalls Division toll-free in Canada at 1-800-333-0510 or 819-994-3328 in the Gatineau-Ottawa area or internationally; you may also go to the following websites for more information:

- English: <https://www.tc.gc.ca/recalls>
- French: <https://www.tc.gc.ca/rappels>

Limited Warranty

! **NOTE** Damage to the vehicle arising from violation of these operating instructions.

Damage to the vehicle can arise from violation of these operating instructions.

This damage is not covered either by the Mercedes-Benz implied warranty or by the New- or Used-Vehicle Warranty.

► Follow the instructions in these operating instructions on proper operation of your vehicle as well as on possible vehicle damage.

QR code for rescue card

QR codes are attached in the fuel filler flap and on the opposite side on the B-pillar. In the event of an accident, rescue services can use the QR code to quickly find the appropriate rescue card for your vehicle. The current rescue card contains the most important information about your

vehicle in a compact form, e.g. the routing of the electric lines.

Further information can be obtained at <https://www.mercedes-benz.de/qr-code>.

Data storage

Data processing in the vehicle

Electronic control units

Electronic control units are installed in your vehicle. Control units process data which, for example, they receive from vehicle sensors, generate themselves or exchange between themselves. Some control units are required for the safe operation of your vehicle, some assist you when driving, such as driver assistance systems, while others enable convenience or infotainment functions.

The following provides you with general information regarding data processing in the vehicle. Additional information regarding exactly which data in your vehicle are collected, saved and transmitted to third parties, and for what purpose, can be found in the information directly

related to the functional characteristics in question in their respective Operator's Manual. This information is also available online and, depending on the vehicle equipment, digitally.

Personal data

Every vehicle is identified by a unique vehicle identification number. Depending on the country, this vehicle identification number can be used by, for example, governmental authorities to determine the identity of the owner. There are other possibilities to use data collected from the vehicle to identify the owner or driver, such as the license plate number.

Therefore, data generated or processed by control units may be attributable to a person or, under certain conditions, become attributable to a person. Depending on which vehicle data are available, it may be possible to make inferences about, for example, your driving behavior, your location, your route or your use patterns.

Legal requirements regarding the disclosure of data

If legally required to do so, manufacturers are, in individual cases, legally obliged to provide gov-

ernmental entities, upon request and to the extent required, data stored by the manufacturer. For example, this may be the case during the investigation of a criminal offense.

Governmental entities are themselves, in individual cases and within the applicable legal framework, authorized to read out data from the vehicle. In the case of an accident, information that can help with an investigation can, therefore, be taken from the airbag control unit, for example.

Operational data in the vehicle

This is data regarding the operation of the vehicle, which have been processed by control units.

This includes the following data, for example:

- Vehicle status information such as the speed, longitudinal acceleration, lateral acceleration, number of wheel revolutions or the fastened seat belts display
- Ambient conditions, such as temperature, rain sensor or distance sensor

Generally, the use of these data is temporary; they will not be stored beyond the period of operation and will only be processed within the

vehicle itself. Control units often contain data memories for vehicle keys, for example. Their use permits the temporary or permanent documentation of technical information about the vehicle's operating state, component loads, maintenance requirements and technical events or malfunctions.

Depending on the vehicle equipment, the following data are stored:

- Operating status of system components, such as fill levels, tire pressure or battery status
- Malfunctions or faults in important system components, such as lights or brakes
- System reactions in special driving situations, such as airbag deployment or the intervention of stability control systems
- Information on events leading to vehicle damage

In certain cases, it may be required to store data that would have otherwise been used only temporarily. This may be the case if the vehicle has detected a malfunction, for example.

If you use services, such as repair services and maintenance work, stored operational data as well as the vehicle identification number can be read out and used. They can be read out by service network employees, such as workshops and manufacturers or third parties, such as breakdown services. The same is true in the case of warranty claims and quality assurance measures.

In general, the readout is performed via the legally prescribed port for the diagnostics connection in the vehicle. The operational data that are read out document technical states of the vehicle or of individual components and assist in the diagnosis of malfunctions, compliance with warranty obligations and quality improvement. To that end, these data, in particular information about component loads, technical events, malfunctions and other faults may be transmitted along with the vehicle identification number to the manufacturer. Furthermore, the manufacturer is subject to product liability. For this reason the manufacturer also uses operational data from the vehicle, for example, for recalls. These

data can also be used to examine the customer's warranty and guarantee claims.

Fault memories in the vehicle can be reset by a service outlet or at your request as part of repair or maintenance work.

Convenience and infotainment functions

You can store convenience settings and individual settings in the vehicle and change or reset them at any time.

Depending on the vehicle equipment, this includes the following settings, for example:

- Seat and steering wheel positions
- Suspension and climate control settings
- Individual settings, such as interior lighting

Depending on the selected equipment, you can import data into vehicle infotainment functions yourself.

Depending on the vehicle equipment, this includes the following data, for example:

- Multimedia data, such as music, films or photos for playback in an integrated multimedia system

- Address book data for use in connection with an integrated hands-free system or an integrated navigation system
- Entered navigation destinations
- Data about the use of Internet services

These data for convenience and infotainment functions may be saved locally in the vehicle or they may be located on a device which you have connected to the vehicle, such as a smartphone, USB flash drive or MP3 player. If you have entered these data yourself, you can delete them at any time.

This data is transmitted from the vehicle to third parties only at your request. This applies, in particular, when you use online services in accordance with the settings that you have selected.

Smartphone integration (e.g. Android Auto or Apple CarPlay®)

If your vehicle is accordingly equipped, you can connect your smartphone or another mobile end device to the vehicle. You can then control them by means of the control elements integrated in the vehicle. Images and audio from the smart-

phone can be output via the multimedia system. Certain information is simultaneously transferred to your smartphone. Depending on the type and integration, this includes position data, day/night mode and other general vehicle statuses. For more information please consult the Operator's Manual of the vehicle/infotainment system.

This integration allows the use of selected smartphone apps, such as navigation or music player apps. There is no further interaction between the smartphone and the vehicle; in particular, vehicle data is not directly accessible. The type of additional data processing is determined by the provider of the app being used. Which settings you can make, if any, depends on the specific app and the operating system of your smartphone.

Online services

Wireless network connection

If your vehicle has a wireless network connection, it enables data to be exchanged between your vehicle and additional systems. The wireless network connection is made possible by the

vehicle's own transmitter and receiver or by a mobile end device that you have brought into the vehicle, for example, a smartphone. Online functions can be used via the wireless network connection. This includes online services and applications/apps provided to you by the manufacturer or by other providers.

Manufacturer's services

Regarding the manufacturer's online services, the individual functions are described by the manufacturer in a suitable place, for example, in the Operator's Manual or on the manufacturer's website, where the relevant data protection information is also given. Personal data may be used for the provision of online services. Data are exchanged via a secure connection, such as the manufacturer's designated IT systems. Any personal data which are collected, processed and used, other than for the provision of services, is done so exclusively on the basis of legal permission. This is the case, for example, for a legally prescribed emergency call system, a contractual agreement or when consent has been given.

You can have services and functions, some of which are subject to a fee, activated or deactivated. This excludes legally prescribed functions and services, such as an emergency call system.

Third party services

If you use online services from other providers (third parties), these services are the responsibility of the provider in question and subject to that provider's data protection conditions and terms of use. As a general rule, the manufacturer has no influence on the content exchanged.

For this reason, when services are provided by third parties, please ask the service provider in question for information about the type, extent and purpose of the collection and use of personal data.

Data protection rights

Depending on your country or the equipment and range of functions of your vehicle as well as the services you use and the services on offer, you are entitled to different data protection rights. Further information on data protection

and your data protection rights can either be found on the manufacturer's website or you will receive this information as part of the various services and service offers. There you will also find the contact information for the manufacturer and its data protection officers.

At a workshop, for example, with the support of a specialist and possibly for a fee, you can have data read out which is stored only locally in the vehicle.

MBUX multimedia system/Mercedes me connect

If the vehicle is equipped with the MBUX multimedia system or Mercedes me connect, additional data about the vehicle's operation, the use of the vehicle in certain situations, and the location of the vehicle may be compiled by the MBUX multimedia system or Mercedes me connect.

For additional information, please refer to the "MBUX multimedia system" section and/or the Mercedes me connect Terms and Conditions.

Event data recorders

USA only:

This vehicle is equipped with an event data recorder (EDR). The main purpose of an EDR is to record, in certain crash or near crash-like situations, such as an airbag deployment or hitting a road obstacle, data that will assist in understanding how a vehicle's systems performed. The EDR is designed to record data related to vehicle dynamics and safety systems for a short period of time, typically 30 seconds or less.

The EDR in this vehicle is designed to record such data as:

- How various systems in your vehicle were operating
- Whether or not the driver and front passenger seat belts were buckled/fastened
- How far (if at all) the driver was depressing the accelerator and/or brake pedal and
- How fast the vehicle was traveling

This data can help provide a better understanding of the circumstances in which accidents and injuries occur. NOTE: EDR data is recorded by

your vehicle only if a non-trivial crash situation occurs; no data is recorded by the EDR under normal driving conditions and no personal data (e.g. name, gender, age and accident location) is recorded. However, other parties, such as law enforcement, could combine EDR data with the type of personally identifying data routinely acquired during a crash investigation.

To read data recorded by an EDR, special equipment is required, and access to the vehicle or the EDR is needed. In addition to the vehicle manufacturer, other parties that have the special equipment, such as law enforcement, can read the information by accessing the vehicle or the EDR.

EDR data may be used in civil and criminal matters as a tool in accident reconstruction, accident claims and vehicle safety. Since the Crash Data Retrieval (CDR) tool that is used to extract data from the EDR is commercially available, Mercedes-Benz USA, LLC ("MBUSA") expressly disclaims any and all liability arising from the extraction of this information by unauthorized Mercedes-Benz personnel.

MBUSA will not share EDR data with others without the consent of the vehicle owner or, if the vehicle is leased, without the consent of the lessee. Exceptions to this representation include responses to subpoenas by law enforcement; by federal, state or local government; in connection with or arising out of litigation involving MBUSA or its subsidiaries and affiliates; or, as required by law.

Warning: The EDR is a component of the Restraint System Module. Tampering with, altering, modifying or removing the EDR component may result in a malfunction of the Restraint System Module and other systems.

State laws or regulations regarding EDRs that conflict with federal regulation are pre-empted. This means that in the event of such conflict, the federal regulation governs. As of December 2016, 17 states have enacted laws relating to EDRs.

Copyright

Free and open source software

Information on license for free and open-source software used in your vehicle can be found on the data carrier in your vehicle document wallet and with updates on the following website:

<https://www.mercedes-benz.com/opensource>

Registered trademarks

- Bluetooth® is a registered trademark of Bluetooth SIG, Inc.
- DTS™ is a registered trademark of DTS, Inc.
- Dolby® and MLP™ are registered trademarks of DOLBY Laboratories.
- ESP® and PRE-SAFE® are registered trademarks of Daimler AG.
- HomeLink® is a registered trademark of Genetex Corporation.
- iPod® and iTunes® are registered trademarks of Apple Inc.

- Burmester® is a registered trademark of Burmester Audiosysteme GmbH.
- Microsoft® and Windows Media® are registered trademarks of Microsoft Corporation.
- SIRIUS® is a registered trademark of Sirius XM Radio Inc.
- HD Radio™ is a registered trademark of iBiquity Digital Corporation.
- Gracenote® is a registered trademark of Gracenote, Inc.
- ZAGAT Survey® and related brands are registered trademarks of Zagat Survey, LLC.

Restraint system

Protection provided by the restraint system

The restraint system includes the following components:

- Seat belt system
- Airbags
- Child restraint system
- Child seat securing systems

The restraint system can help prevent the vehicle occupants from coming into contact with parts of the vehicle interior in the event of an accident. In the event of an accident, the restraint system can also reduce the forces to which the vehicle occupants are subjected.

A seat belt can only provide the best level of protection if it is worn correctly. Depending on the detected accident situation, Emergency Tensioning Devices and/or airbags supplement the protection offered by a correctly worn seat belt. Emergency Tensioning Devices and/or airbags are not deployed in every accident.

In order for the restraint system to provide the intended level of protection, each vehicle occupant must observe the following information:

- Fasten seat belts correctly.
- Sit in an almost upright seat position with their back against the seat backrest.
- Sit with their feet resting on the floor, if possible.
- Always secure persons under 5 ft (1.50 m) tall in an additional restraint system suitable for Mercedes-Benz vehicles.

However, no system available today can completely eliminate injuries and fatalities in every accident situation. In particular, the seat belt and airbag generally do not protect against objects penetrating the vehicle from the outside. It is also not possible to completely rule out the risk of injury caused by the airbag deploying.

Reduced restraint system protection

▲ WARNING Risk of injury or death due to modifications to the restraint system

Vehicle occupants may no longer be protected as intended if alterations are made to the restraint system.

- ▶ Never alter the parts of the restraint system.
- ▶ Never tamper with the wiring or any electronic component parts or their software.

If it is necessary to modify the vehicle to accommodate a person with disabilities, contact an authorized Mercedes-Benz Center for details.

USA only: for details, contact our Customer Assistance Center on 1-800-FOR-MERCEdes (1-800-367-6372).



Restraint system functionality

When the ignition is switched on, a self-test is performed, during which the  restraint sys-

tem warning lamp lights up. It goes out no later than a few seconds after the vehicle is started. The components of the restraint system are then functional.

Malfunctioning restraint system

A malfunction has occurred in the restraint system if:

- The  restraint system warning lamp does not light up when the ignition is switched on
- The  restraint system warning lamp lights up continuously or repeatedly during a journey

⚠ WARNING Risk of injury due to malfunctions in the restraint system

Components in the restraint system may be activated unintentionally or not deploy as planned in an accident.

- ▶ Have the restraint system checked and repaired immediately at a qualified specialist workshop.

Function of the restraint system in an accident

How the restraint system works depends on the severity of the impact detected and the apparent type of accident:

- Frontal impact
- Rear impact
- Side impact
- Rollover

The activation thresholds for the components of the restraint system are determined based on the evaluation of the sensor values measured at various points in the vehicle. This process is pre-emptive in nature. The triggering/deployment of the components of the restraint system must take place in good time at the start of the collision.

Factors which can only be seen and measured after a collision has occurred cannot play a decisive role in airbag deployment. Nor do they provide an indication of airbag deployment.

The vehicle may be deformed significantly without an airbag being deployed. This is the case if

only parts which are relatively easily deformed are affected and the rate of vehicle deceleration is not high. Conversely, an airbag may be deployed even though the vehicle suffers only minor deformation. If very rigid vehicle parts such as longitudinal members are hit, this may result in sufficiently high levels of vehicle deceleration.

Depending on the detected deployment situation, the components of the restraint system can be activated or deployed independently of each other:

- Emergency Tensioning Device: frontal impact, rear impact, side impact, rollover
- Driver's airbag, front passenger airbag: frontal impact
- Knee airbag: frontal impact
- Side airbag: side impact
- Window curtain airbag: side impact, rollover, frontal impact
- Rear airbag: frontal impact
- Belt airbag: frontal impact
- Cushionbag: frontal impact

44 Occupant safety

- PRE-SAFE® Impulse Side: side impact

The front passenger airbag can only be deployed in an accident if the PASSENGER AIR BAG OFF indicator lamp is off. If the front passenger seat is occupied, make sure, both before and during the journey, that the status of the front passenger airbag is correct (→ page 55).

⚠ WARNING Risk of burns from hot air bag components

The air bag parts are hot after an air bag has been deployed.

- ▶ Do not touch the air bag parts.
- ▶ Have a deployed air bag replaced at a qualified specialist workshop as soon as possible.

Mercedes-Benz recommends that you have the vehicle towed to a qualified specialist workshop after an accident. Take this into account, particularly if an Emergency Tensioning Device is triggered or an airbag deployed.

If the Emergency Tensioning Devices are triggered or an airbag is deployed, you will hear a bang, and a small amount of powder may also be released:

- The bang will not generally affect your hearing.
- In general, the powder released is not hazardous to health but may cause short-term breathing difficulties to persons suffering from asthma or other pulmonary conditions. Provided it is safe to do so, leave the vehicle immediately or open the window in order to prevent breathing difficulties.

Airbags and pyrotechnic Emergency Tensioning Devices contain perchlorate material, which may require special handling or environmental protection measures. National guidelines regarding waste disposal must be observed. In California, see <https://dtsc.ca.gov/>. Using the search function, you will find information on perchlorate, for example.

Seat belts

Protection provided by the seat belt

Always fasten your seat belt correctly before starting a journey. A seat belt can only provide the best level of protection if it is worn correctly.

⚠ WARNING Risk of injury or death due to incorrectly fastened seat belt

If the seat belt is not worn correctly, it cannot perform its intended protective function.

In addition, an incorrectly fastened seat belt can also cause injuries, for example, in the event of an accident or when braking or changing direction suddenly.

- ▶ Always ensure that all vehicle occupants have their seat belts fastened correctly and are sitting properly.

Always observe the instructions about the correct driver's seat position and adjusting the seat (→ page 106).

In order for the correctly worn seat belt to provide the intended level of protection, each vehicle occupant must observe the following information:

- The seat belt must not be twisted and must fit tightly and snugly across the body.
- The seat belt must be routed across the center of the shoulder and as low down across the hips as possible.
- The shoulder section of the seat belt should not touch your neck nor be routed under your arm or behind your back.
- Avoid wearing bulky clothing, e.g. a winter coat.
- Push the lap belt down as far as possible across your hips and pull tight with the shoulder section of the belt. Never route the lap belt across your abdomen.
Pregnant women must also take particular care with this.
- Never route the seat belt across sharp, pointed, abrasive or fragile objects.

- Only one person should use each seat belt at any one time. Never allow babies and children to travel sitting on the lap of another vehicle occupant.
- Never secure objects with a seat belt if the seat belt is also being used by one of the vehicle's occupants. Always observe the instructions for loading the vehicle when securing objects, luggage or loads (→ page 134).
Also ensure that no objects, e.g. a cushion, are ever placed between a person and the seat.

The seat belts on the following seats are equipped with a special seat belt retractor:

- Front passenger seat
- Rear seats

Activate or deactivate the special seatbelt retractor (→ page 66).

If children are traveling in the vehicle, be sure to observe the instructions and safety notes on "Children in the vehicle" (→ page 63).

Limitations of the protection provided by the seat belt

⚠ WARNING Risk of injury or death due to an incorrect seat position

The seat belt does not offer the intended level of protection if you have not moved the seat backrest to an almost vertical position.

In particular, you could slip beneath the seat-belt and become injured.

- ▶ Adjust the seat properly before beginning your journey.
- ▶ Always ensure that the seat backrest is in an almost vertical position and that the shoulder belt is routed across the center of your shoulder.

⚠ WARNING Risk of injury or death when additional restraint systems are not used for persons with a smaller stature

Persons under 5 ft (1.50 m) tall cannot wear the seat belt correctly without a suitable additional restraint system.

- ▶ Always secure persons under 5 ft (1.50 m) tall in a suitable restraint system.

⚠ WARNING Risk of injury or death due to blocked seat belt buckle or seat belt anchorage

Objects next to the front seat that block the seat belt buckle or the moving seat belt anchorage on the front seat impair the function of the Emergency Tensioning Devices.

- ▶ Before starting the journey, make sure that there are no objects around the seat belt buckle or between the front seat and door.

⚠ WARNING Risk of injury or death due to damaged or modified seat belts

Seat belts cannot provide protection in the following situations:

- The seat belt is damaged, has been modified, is extremely dirty, bleached or dyed

- The seat belt buckle is damaged or extremely dirty
- Modifications have been made to the Emergency Tensioning Device, seat belt anchorage or seat belt retractor

Seat belts may sustain non-visible damage in an accident, e.g. due to glass splinters.

Modified or damaged seat belts could tear or fail in the event of an accident, for example.

Modified Emergency Tensioning Devices could accidentally trigger or fail to function as intended.

- ▶ Never modify the seat belt system, for example the seat belt, seat belt buckle, Emergency Tensioning Device, seat belt anchorage and seat belt retractor.
- ▶ Make sure that the seat belts are undamaged, not worn and clean.
- ▶ Always have the seat belts checked immediately after an accident at a qualified specialist workshop.

Only use seat belts which have been approved for your vehicle by Mercedes-Benz.

⚠ WARNING Risk of injury or death from deployed pyrotechnic Emergency Tensioning Devices

Pyrotechnic Emergency Tensioning Devices that have been deployed are no longer operational and are unable to perform their intended protective function.

- ▶ Therefore, have deployed pyrotechnic Emergency Tensioning Devices immediately replaced at a qualified specialist workshop.

Mercedes-Benz recommends that you have the vehicle towed to a qualified specialist workshop after an accident.

! NOTE Damage caused by trapping the seat belt

If an unused seat belt is not fully retracted, it may become trapped in the door or in the seat mechanism.

- ▶ Always ensure that an unused seat belt is fully retracted.

Information on the beltbag in the rear seat belt

The BELTBAG identification indicates that a rear seat belt is equipped with a beltbag.

When activated, the beltbag increases the protected area of the vehicle occupant's ribcage.

⚠ WARNING Risk of injury or death due to use of a non-approved child restraint system

In an accident, the beltbag may damage a non-approved child restraint system or a child restraint system which has not been approved for use in conjunction with the beltbag.

- ▶ Therefore, always use LATCH or ISOFIX to fasten a child seat equipped with an integrated restraint system.
- ▶ For vehicles equipped with the optional rear seat-belt airbags ("beltbag"), only

use a Mercedes-Benz approved booster seat with integrated backrest.

- ▶ Never use an airbag equipped seat belt to fasten a front- or rear-facing child seat or a non-approved booster seat.
- ▶ Please contact an authorized Mercedes-Benz Center for information on approved child restraint systems.

Extending/retracting the seat belt extender in the rear passenger compartment

The seat belt extender for the rear seat helps you fasten your seat belt.

- ▶ Close the door.
The seat belt extender extends.
- ⓘ If the vehicle is equipped with the MBUX Interior Assistant, the seat belt extender extends when you reach for the seat belt tongue.

The seat belt extender retracts again in the following cases:

- The seat belt tongue is engaged in the seat belt buckle
- The seat belt tongue is not engaged in the seat belt buckle within a certain time
- The respective door is opened
- A certain speed is exceeded after pulling away

⚠ WARNING Risk of injury or death due to an extended seat belt extender while the vehicle is in motion

If the seat belt does not sit correctly on the body, it cannot perform its intended protective function.

- ▶ Always ensure that the seat belt extender is retracted while the vehicle is in motion.

If the seat belt extender does not retract automatically, it can be retracted manually. To do so, press the seat belt extender back as far as it will

go before starting the vehicle. Pressing the seat belt extender back into place requires force.

- i** You can deactivate the seat belt extender. Activate the child safety lock for the rear passenger compartment side windows (→ page 75). When installing a child restraint system to the rear seat, observe the vehicle-specific information (→ page 66).

Fastening and adjusting seat belts

If the seat belt is pulled quickly or sharply, the seat belt retractor locks. The seat belt strap cannot be pulled out any further.

Vehicles with illuminated design seat belt buckles: the illuminated seat belt buckle makes fastening your seat belt easier in certain situations, for example, when ambient light conditions are poor.

- i** The illumination on the seat belt buckle does not indicate that the seat belt buckle is functioning correctly.

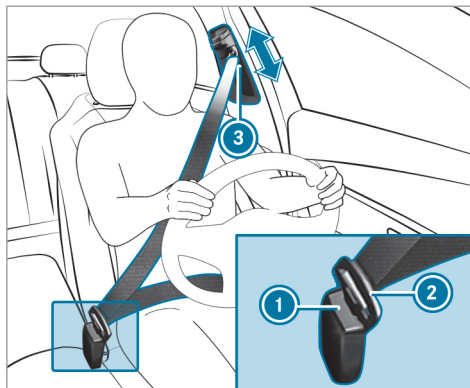

- ▶ Always engage seat belt tongue **2** of the seat belt into seat belt buckle **1** of the corresponding seat.
- ▶ Press and hold the seat belt outlet release and slide seat belt outlet **3** into the desired position.
- ▶ Let go of the seat belt outlet release and ensure that seat belt outlet **3** locks into position.

- i** A seat belt can only provide the best level of protection if it is worn correctly. Observe the notes on fastening the seat belt (→ page 44).

! **NOTE** Deployment of components of the restraint system when the front passenger seat is unoccupied and a seat belt is buckled

When the front passenger seat is unoccupied and the seat belt tongue of the seat belt is engaged in the seat belt buckle, components of the restraint system may deploy unnecessarily on the front passenger side, e.g. the Emergency Tensioning Device.

- ▶ Only buckle the seat belts as intended.

- i** Observe the notes on correctly fastening the seat belt (→ page 44) and stowage options (→ page 134). Information on installing a child restraint system and on children traveling in the vehicle can be found in the "Children in the vehicle" section (→ page 66).

Seat belt adjustment function

Vehicles with PRE-SAFE®: After a front seat belt has been fastened, the automatic seat belt adjustment may apply a certain tightening force. Do not hold the seat belt tightly while it is adjusting.

You can activate and deactivate the seat belt adjustment function using the multimedia system (→ page 49).

Activating/deactivating seat belt adjustment via the multimedia system

Multimedia system:

→  » Settings » Vehicle
» Occupant Protection

▶ Activate or deactivate [Belt adjustment](#).

Releasing seat belts

▶ Press the release button in the seat belt buckle and guide the seat belt back with the seat belt tongue.

Seat belt warning function for the driver and front passenger

The  seat belt warning lamp in the driver's display is a reminder that all vehicle occupants must wear their seat belts correctly.

The  seat belt warning lamp lights up for six seconds every time the vehicle is started.

In addition, a warning tone may sound.

When the driver's and front passenger's doors are closed and the driver and front passenger have fastened their seat belts, the seat belt warning goes out.

In the following cases, the seat belt warning lights up during a journey if:

- The vehicle speed exceeds 15 mph (25 km/h) and the driver's or front passenger seat belt is not fastened.
- The driver or front passenger unfastens their seat belt while the vehicle is in motion.

Airbags

Overview of airbags

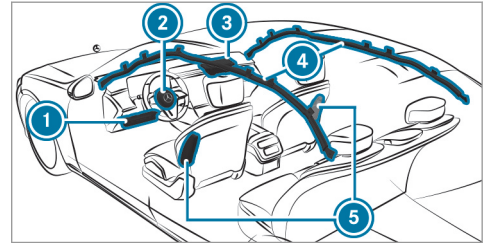

Driver's/front passenger seat:

- ① Knee airbag
- ② Driver's airbag
- ③ Front passenger airbag
- ④ Window curtain airbag
- ⑤ Side airbag

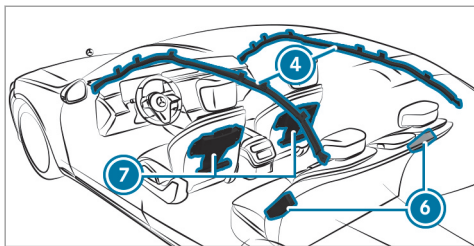

Rear seats:

- ④ Window curtain airbag
- ⑥ Side airbag
- ⑦ Rear airbag

The installation location of an airbag is identified by the AIRBAG symbol. An additional arrow symbol ► indicates the installation location for certain airbags.

When enabled, an airbag can provide additional protection for the respective vehicle occupant.

Potential protection provided by each airbag:

- Knee airbag: thigh, knee and lower leg

- Driver's airbag, front passenger airbag: head and ribcage
- Window curtain airbag: head
- Side airbag: ribcage, also pelvis for front seat occupants
- Rear airbag: head

Information on child restraint systems on the front passenger seat

⚠ WARNING Risk of injury or death if the co-driver airbag is enabled

If the co-driver airbag is enabled, a child on the co-driver seat may be struck by the co-driver airbag during an accident.

NEVER use a rearward-facing child restraint system on a seat with an ENABLED FRONT AIRBAG; DEATH or SERIOUS INJURY to the CHILD can occur.

When installing a child restraint system to the front passenger seat, observe the vehicle-specific information (→ page 72). Also, always observe the notes on rearward-facing or

forward-facing child restraint systems on the front passenger seat (→ page 72).

Information on automatic front passenger airbag shutoff

The front passenger airbag can only be deployed in an accident if the PASSENGER AIR BAG OFF indicator lamp is off. If the front passenger seat is occupied, make sure, both before and during the journey, that the status of the front passenger airbag is correct (→ page 55).

! NOTE Deployment of components of the restraint system when the front passenger seat is unoccupied

In an accident, the components of the restraint system may deploy unnecessarily on the front passenger side if:

- There are heavy objects on the front passenger seat.
- The seat belt tongue is engaged in the seat belt buckle of the front passenger seat and the front passenger seat is unoccupied.

- ▶ Store objects in a suitable place.
- ▶ Only one person should use each seat belt at any one time.

Depending on the detected accident situation, the window curtain airbag on the front passenger side may deploy. The airbag is deployed regardless of whether the front passenger seat is occupied.

Information on the rear airbag

Always observe the information on the rear airbag, especially in the following situations:

- A person is sitting on the outer rear seat.
- You install a child restraint system on the outer rear seat.
- You stow objects behind the front seats.

Before beginning the journey, observe the information on the rear airbag (→ page 57). Be aware of the status of the respective rear airbag depending on the situation both before and during the journey (→ page 59).

Information on the cushionbag in the reclining rear seat

The cushionbag offers additional occupant protection in the event of frontal impacts. When enabled, the cushionbag deploys under the seat cushion. This helps prevent the vehicle occupant from slipping off the seat cushion.

If you install a child restraint system on the reclining rear seat, always observe the additional notes (→ page 66).

Protective capacity of the airbags

Depending on the accident situation, an airbag may supplement the protection offered by a correctly fastened seat belt.

▲ WARNING Risk of injury or death due to an incorrect seat position

If you deviate from the correct seat position, the airbag cannot perform its intended protective function.

Each vehicle occupant must make sure of the following:

- Fasten seat belts correctly. Pregnant women must take particular care to ensure that the lap belt never lies across the abdomen.
- Adopt the correct seat position and keep as far away as possible from the airbags.
- Observe the following information.

▶ Always make sure that there are no objects between the airbag and vehicle occupant.

To avoid the risks resulting from the deployment of an airbag, each vehicle occupant must observe the following information in particular:

- Before starting your journey, adjust your seat correctly; the driver's seat and front passenger seat should be moved as far back as possible.

When doing so, always observe the information on the correct driver's seat position (→ page 106).

Vehicles with rear airbag: always observe the information on the rear airbag when the rear seat is occupied (→ page 57). The vehicle occupants should sit as far back from the airbags as possible and keep an equal distance to them.

- Only hold the steering wheel by the steering wheel rim. This allows the airbag to be fully deployed.
- Always lean against the seat backrest when the vehicle is in motion. Do not lean forwards or against the door or side window. You may otherwise be in the deployment area of the airbags.
- The occupants must always keep their feet on the floor. Do not put your feet on the cockpit, for example. Your feet may otherwise be in the deployment area of the airbag.

Vehicles with rear airbag: always observe the information on the rear airbag when the rear seat is occupied (→ page 57).

- If children are traveling in the vehicle, observe the additional notes (→ page 63).
- Always store and secure objects correctly.

Objects in the vehicle interior may prevent an airbag from functioning correctly. Each vehicle occupant must always make sure of the following in particular:

- There are no people, animals or objects between the vehicle occupants and an airbag.

Vehicles with rear airbag: also observe the information on the rear airbag (→ page 57).

- There are no objects between the seat, door and door pillar (B-pillar).
- There are no hard objects, e.g. coat hangers, hanging on the grab handles or coat hooks.
- There are no accessory parts, such as mobile navigation devices, mobile phones or cup holders, within the deployment area of an airbag, e.g. on the cockpit, on the door, on the side window or on the side trim.

In addition, no connecting cables, tensioning straps or retaining straps must be routed or attached to the vehicle within the deployment area of an airbag. Always comply with the accessory manufacturer's installation

instructions and, in particular, the notes on suitable places for installation.

- There are no heavy, sharp-edged or fragile objects in the pockets of your clothing. Store such objects in a suitable place.

Limited protection provided by airbags

▲ WARNING Risk of injury due to modifications to the cover of an airbag

If you modify the cover of an airbag or affix objects such as stickers to it, the airbag may no longer function correctly.

- ▶ Never modify the cover of an airbag and do not affix objects to it.

The installation location of an airbag is identified by the AIRBAG symbol (→ page 49).

▲ WARNING Risk of injury or death due to the use of unsuitable seat covers

Due to unsuitable seat covers, the airbags cannot protect vehicle occupants as intended.

In addition, the operation of the automatic front passenger airbag shutoff could be restricted.

- ▶ You should only use seat covers that have been approved for the corresponding seats by Mercedes-Benz.

▲ WARNING Risk of injury due to malfunctioning sensors in the door

The function of the airbags can be impaired due to modifications or incorrect work performed on the doors or door trim, or if the doors are damaged.

- ▶ Never modify the doors or parts of the doors.

- ▶ Always have work on the doors or door trim carried out at a qualified specialist workshop.

▲ WARNING Risk of injury due to deployed airbag

A deployed airbag no longer offers any protection.

- ▶ Have the vehicle towed to a qualified specialist workshop in order to have the deployed airbag replaced.

Have deployed airbags replaced immediately.

Status of the front passenger front airbag

Function of the automatic front passenger airbag shutoff

The automatic front passenger airbag shutoff is able to detect whether the front passenger seat is occupied by a person or a child restraint system. The front passenger airbag is enabled or disabled accordingly.

▲ WARNING Risk of injury or death due to objects under the co-driver seat

Objects trapped under the co-driver seat can interfere with the function of the automatic co-driver airbag shutoff or damage the system.

- ▶ Do not store any objects under the co-driver seat.
- ▶ When the co-driver seat is occupied, make sure that no objects are trapped under the co-driver seat.

When installing a child restraint system on the front passenger seat, observe the vehicle-specific information (→ page 72). Also, always observe the notes on rearward-facing or forward-facing child restraint systems on the front passenger seat (→ page 72).

▲ WARNING Risk of injury or death due to objects between the seat surface and the child restraint system

Objects between the sitting surface and the child restraint system could affect the function of the automatic co-driver airbag shut-off.

- ▶ Do not place any objects between the sitting surface and the child restraint system.
- ▶ Make sure that the entire base of the child restraint system is resting on the sitting surface of the co-driver seat.
- ▶ Make sure that the backrest of the forward-facing child restraint system is, as far as possible, resting on the seat backrest of the co-driver seat.
- ▶ Always comply with the child restraint system manufacturer's installation instructions.

A person on the front passenger seat must observe the following information:

- Fasten seat belts correctly (→ page 44).
- Sit in an almost upright seat position with their back against the seat backrest.
- Sit with their feet resting on the floor, if possible.

The front passenger airbag may otherwise be disabled by mistake, for example, in the following situations:

- The front passenger transfers their weight by supporting themselves on a vehicle armrest.
- The front passenger sits in such a way that their weight is raised from the sitting surface.

▲ WARNING Risk of injury or death due to a disabled front passenger airbag

The front passenger airbag is disabled when the PASSENGER AIR BAG OFF indicator lamp is lit.

A person in the front passenger seat could then, for example, come into contact with the vehicle interior, especially if the person is sitting too close to the cockpit.

If the front passenger seat is occupied, always ensure that:

- The classification of the person in the front passenger seat is correct and the front passenger airbag is enabled or disabled in accordance with the person in the front passenger seat.
 - The front passenger seat has been moved as far back as possible.
 - The person is seated correctly.
- ▶ Both before and during the journey, ensure that the status of the front passenger airbag is correct.

If the front passenger seat is occupied, the classification of the person or child restraint system on the front passenger seat takes place after the front passenger airbag shutoff self-test. The PASSENGER AIR BAG indicator lamps display the status of the front passenger airbag.

Always observe the notes on the function of the PASSENGER AIR BAG indicator lamps (→ page 55).

Function of the PASSENGER AIR BAG indicator lamps



Self-test of automatic front passenger airbag shutoff

When the ignition is switched on, a self-test is performed during which the two PASSENGER AIR BAG ON and OFF indicator lamps light up simultaneously.

The status of the front passenger airbag is displayed via the PASSENGER AIR BAG indicator lamps after the self-test:

- **ON is lit:** the front passenger airbag may deploy during an accident.
The indicator lamp goes out after 60 seconds.
- **ON and OFF are not lit:** the front passenger airbag may deploy during an accident.
- **OFF is lit:** the front passenger airbag is disabled. It will then not be deployed in the event of an accident.

If the PASSENGER AIR BAG ON indicator lamp is off, only the PASSENGER AIR BAG OFF indicator lamp shows the status of the front passenger airbag. The PASSENGER AIR BAG OFF indicator lamp may be lit continuously or be off.

If the PASSENGER AIR BAG OFF indicator lamp and the  restraint system warning lamp light up simultaneously, the front passenger seat may not be used. Also in this case, do not install a child restraint system on the front passenger seat. Have the automatic front passenger airbag shutoff checked and repaired immediately at a qualified specialist workshop.

Status display

If the front passenger seat is occupied, ensure, both before and during the journey, that the status of the front passenger airbag is correct for the current situation.

After installing a rearward-facing child restraint system on the front passenger seat: PASSENGER AIR BAG OFF must be lit continuously.

▲ WARNING Risk of injury or fatal injury when using a rearward-facing child restraint system while the co-driver airbag is enabled

If you secure a child in a rearward-facing child restraint system on the co-driver seat and the PASSENGER AIR BAG OFF indicator lamp is off, the co-driver airbag can deploy in the event of an accident.

The child could be struck by the airbag.

- ▶ Always ensure that the co-driver airbag is disabled. The PASSENGER AIR BAG OFF indicator lamp must be lit.
- ▶ NEVER use a rearward-facing child restraint system on a seat with an ENABLED FRONT AIRBAG; DEATH or SERIOUS INJURY to the CHILD can occur.

When installing a child restraint system on the front passenger seat, observe the vehicle-specific information (→ page 72).

Depending on the child restraint system and the stature of the child, the PASSENGER AIR BAG OFF indicator lamp may be off. In this case, do

not install the rearward-facing child restraint system on the front passenger seat.

Instead, install the rearward-facing child restraint system on a suitable rear seat.

After installing a forward-facing child restraint system on the front passenger seat:

depending on the child restraint system and the stature of the child, PASSENGER AIR BAG OFF may be lit continuously or be off. Always observe the following information.

▲ WARNING Risk of injury or death due to incorrect positioning of the forward-facing child restraint system

If you secure a child in a forward-facing child restraint system on the front passenger seat that is positioned too close to the cockpit, in the event of an accident, the child could:

- come into contact with the vehicle interior if the PASSENGER AIR BAG OFF indicator lamp is lit, for example
- be struck by the airbag if the PASSENGER AIR BAG OFF indicator lamp is off.

- ▶ Always move the front passenger seat as far back as possible and fully retract the seat cushion length adjustment. While doing so, always make sure that the shoulder belt strap is correctly routed from the seat belt outlet of the vehicle to the shoulder belt guide on the child restraint system. The shoulder belt strap must be routed forwards and downwards from the seat belt outlet. If necessary, adjust the seat belt outlet and the front passenger seat accordingly.
- ▶ Always comply with the child restraint system manufacturer's installation instructions.

When installing a child restraint system on the front passenger seat, observe the vehicle-specific information (→ page 72).

If a person is sitting on the front passenger seat: PASSENGER AIR BAG OFF may be lit continuously or be off, depending on the person's stature.

A person on the front passenger seat must always observe the following information:

- If the front passenger seat is occupied by an adult or a person with a stature corresponding to that of an adult, the PASSENGER AIR BAG OFF indicator lamp must be off. This indicates that the front passenger airbag is enabled.
If the PASSENGER AIR BAG OFF indicator lamp is lit continuously, an adult or person with a build corresponding to that of an adult must not use the front passenger seat. Instead, they should use a rear seat.
- If the front passenger seat is occupied by a person of smaller stature (e.g. a teenager or small adult), the PASSENGER AIR BAG OFF indicator lamp is either lit continuously or remains off, depending on the classification.
 - If the PASSENGER AIR BAG OFF indicator lamp is off: move the front passenger seat as far back as possible, or the person of smaller stature should use a rear seat.

- If the PASSENGER AIR BAG OFF indicator lamp is lit continuously: the person of smaller stature should not use the front passenger seat.

⚠ WARNING Risk of injury or death when the PASSENGER AIR BAG OFF indicator lamp is lit

If the PASSENGER AIR BAG OFF indicator lamp remains lit after the self-test, the front passenger airbag is disabled.

If the front passenger seat is occupied, always ensure that:

- The classification of the person in the front passenger seat is correct and the front passenger airbag is enabled or disabled in accordance with the person in the front passenger seat.
- The person is seated properly with a correctly fastened seat belt.
- The front passenger seat has been moved as far back as possible.

Be sure to also observe the following further related subjects:

- Child restraint system on the front passenger seat (→ page 72)

Information on the rear airbag

Points to remember when the rear seat is occupied

The rear airbag offers the occupants on the outer rear seats additional occupant protection in the event of certain types frontal impacts. When triggered, the rear airbag deploys between the rear seat occupant and the front seat. The rear airbag can help prevent the occupants on the rear seats from coming into contact with parts of the vehicle interior in the event of an accident.

To avoid the risks resulting from the deployment of an airbag, observe the following information:

- Inform persons on the rear seats about the rear airbag in the front seat.
- A person sitting on the rear seat must adopt the correct seat position and sit as far back

from the rear airbag as possible. Adjust the front seats when necessary so that vehicle occupants are sitting as far back from the airbag as possible and at an equal distance to them.

- Observe the notes on airbag protection (→ page 51).

To avoid risks resulting from the deployment of the airbag, vehicle occupants on the outer rear seats must observe the following information in particular:

- The occupants must always keep their feet on the floor. Otherwise, feet and legs of occupants may be in the deployment area of the rear airbag.

If an occupant's feet cannot reach the floor, they must adopt the correct seat position and let their legs hang down the front of the seat.

- The feet or legs of the person on the rear seat must not rest against the seat backrest of the front seat, for example. Otherwise, their feet and legs are in the deployment area of the rear airbag. This should be taken

into consideration especially if you are traveling with a child on the rear seat.

If you are traveling with a child in the left or right rear seat, observe the vehicle-specific information: (→ page 70). Also, always observe the notes on rearward-facing or forward-facing child restraint systems on the left and right rear seats.

- Make sure that the covers for the rear airbags are not damaged.
- Observe the notes on limitations to the protection provided by airbags (→ page 52).

⚠ WARNING Risk of injury due to a damaged rear airbag cover

If a rear airbag cover is damaged, the rear airbag can no longer function correctly and can even cause additional injuries when deployed.

- ▶ Before starting a journey, make sure the covers for the rear airbags are not damaged. If a rear airbag cover is damaged, disable the rear airbag. Have a damaged rear airbag cover replaced at a

qualified specialist workshop as soon as possible.

You can disable or enable the rear airbag via the multimedia system (→ page 60).

Objects behind the front seat

Objects in the deployment area of the rear airbags may prevent the rear airbags from functioning correctly.

⚠ WARNING Risk of injury due to objects placed in front of the rear airbag cover

Objects in front of the rear airbag cover can hinder or prevent the correct deployment of the rear airbag which is integrated into the front seat.

The rear airbag can potentially deploy in an uncontrolled manner and can cause additional injury to the person on the front seat.

- ▶ Always stow and secure objects correctly.

Observe the notes on loading the vehicle (→ page 134).

Disabling/enabling the rear airbag

If, after consideration of the notes and instructions in this Operator's Manual, you deem the additional occupant protection provided by the rear airbag unnecessary, the rear airbag can be disabled.

The rear airbags should be disabled in the following situations in particular:

- A rearward-facing child restraint system is secured on the left or right rear seat.
- The person in the rear seat, for example a child, cannot sit in the correct seat position. Their feet and legs are potentially in the deployment area of the rear airbag.
- Due to the position of the front seats, an occupant's legs, for example, are in the deployment area of the rear airbag.
- Objects are stored behind the front seat which are in the deployment area of the rear airbags.

You can disable or enable the rear airbag via the multimedia system (→ page 60).

Function of the REAR SEAT AIR BAG indicator lamps

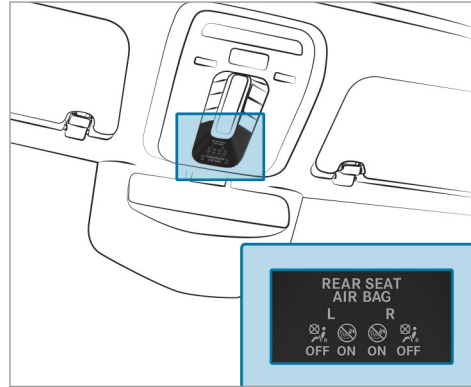

- L** Left rear seat
- R** Right rear seat

When the ignition is switched on, a self-test is performed during which the REAR SEAT AIR BAG ON and OFF indicator lamps light up simultaneously.

After the self-test, the status of the rear airbag for the left and right rear seat is displayed via the REAR SEAT AIR BAG indicator lamps:

- **ON is lit:** the rear airbag may deploy during an accident.
The indicator lamp goes out after approximately 60 seconds.
- **ON and OFF are off:** the rear airbag may deploy during an accident.
- **OFF is lit:** the rear airbag is disabled. It will then not be deployed in the event of an accident.

If the REAR SEAT AIR BAG ON indicator lamp is off, only the REAR SEAT AIR BAG OFF indicator lamp shows the status of the rear airbag. The REAR SEAT AIR BAG OFF indicator lamp may be lit continuously or be off.

Enabling/disabling the rear airbag via the multimedia system

Multimedia system:

- ▶  ▶ Settings ▶ Vehicle
- ▶ Occupant Protection

▶ Enable or disable the desired rear airbag under [Rear Airbags](#).

PRE-SAFE® system

PRE-SAFE® (anticipatory occupant protection)

PRE-SAFE® is able to detect certain critical driving situations and implement pre-emptive measures to protect the vehicle occupants.

PRE-SAFE® can implement the following measures independently of each other:

- Tightening the seat belts on the driver's seat and front passenger seat.
- Closing the side windows.
- **Vehicles with sliding sunroof:** Close the sliding sunroof.

- **Vehicles with memory function:** move the front passenger seat to a more favorable seat position.
- **Vehicles with memory function in the rear compartment:** move the outer rear seats to a more favorable seat position.
- **Vehicles with multicontour seat:** increase the air pressure in the seat side bolsters of the seat backrest.
- PRE-SAFE® Sound: provided that the multimedia system is switched on, generates a brief noise signal to stimulate the innate protective mechanism of a person's hearing.

! **NOTE** Damage caused by objects in the footwell or behind the seat

The automatic adjustment of the seat position may result in damage to the seat and/or the object.

▶ Stow objects in a suitable place.

Reversing the PRE-SAFE® system measures

If an accident did not occur, the pre-emptive measures that were taken are reversed.

You will need to perform certain settings yourself.

- ▶ If the seat belt pre-tensioning is not reduced, move the seat backrest back slightly. The locking mechanism releases.

Function of PRE-SAFE® PLUS (anticipatory occupant protection plus)

PRE-SAFE® PLUS can detect certain impacts, particularly an imminent rear impact, and take pre-emptive measures to protect the vehicle occupants. These measures cannot necessarily prevent an imminent impact.

PRE-SAFE® PLUS can implement the following measures independently of each other:

- Tightening the seat belts on the driver's seat and front passenger seat.
- Increasing brake pressure when the vehicle is stationary. This brake application is can-

ceded automatically when the vehicle pulls away.

If an accident did not occur, the pre-emptive measures that were taken are reversed.

System limits

The system will not initiate any action in the following situations:

- When backing up

The system will not initiate any braking application in the following situations:

- Whilst driving
- or
- When entering or exiting a parking space while using Active Parking Assist

Function of PRE-SAFE® Impulse Side

If an imminent side impact is detected, PRE-SAFE® Impulse Side can pre-emptively move the front seat vehicle occupant's upper body towards the center of the vehicle. It does this by rapidly inflating an air cushion in the outer seat

side bolster of the seat backrest on the side on which the impact is anticipated. This increases the distance between the door and the vehicle occupant.

Vehicles with E-ACTIVE BODY CONTROL: the body can also be slightly raised.

If PRE-SAFE® Impulse Side has been deployed or is faulty, the [PRE-SAFE Impulse Side Inoperative](#) See [Operator's Manual](#) (→ page 504) display message appears.

Automatic measures after an accident

Depending on the type and severity of the accident, and depending on the vehicle's equipment, the following measures can be implemented, for example:

- Automatic braking (post-collision brake)
- Activating the hazard warning lights
- Triggering an automatic emergency call (→ page 327)
- Switching off the engine

To restart the vehicle, switch the ignition off and switch it back on (→ page 190). Depending on the type and severity of the accident, it is possible that the vehicle can no longer be started.

- Switching off the fuel supply
- Unlocking the vehicle doors
- Lowering the side windows
- Displaying the emergency guide in the central display
- Switching on the interior lighting

Function of the post-collision brake

Depending on the accident situation, the post-collision brake can minimize the severity of a further collision or even avoid it.

If an accident is detected, the post-collision brake can implement automatic braking. When the vehicle has come to a standstill, the electric parking brake is automatically applied.

The driver can cancel automatic braking by taking the following actions:

- Braking more strongly than automatic braking

- Fully depressing the accelerator pedal with force

Safely transporting children in the vehicle

Always observe when children are traveling in the vehicle

- ① Also strictly observe the safety notes for the specific situation. In this way you can recognize potential risks and avoid dangers if children are traveling in the vehicle (→ page 63).

Be diligent

Bear in mind that negligence when securing a child in the child restraint system may have serious consequences. Always be diligent in securing a child carefully before every journey.

To improve protection for children younger than 12 years old or under 5 ft (1.50 m) in height, Mercedes-Benz recommends you observe the following information:

- Always secure the child in a child restraint system suitable for this Mercedes-Benz vehicle.

- The child restraint system must be appropriate to the age, weight and size of the child.
- The vehicle seat must be suitable for installing a child restraint system.

Accident statistics show that children secured on the rear seats are generally safer than children secured on the front seats. For this reason, Mercedes-Benz strongly advises that you install a child restraint system on a rear seat.

The generic term child restraint system

The generic term child restraint system is used in this Operator's Manual. A child restraint system is, for example:

- A baby car seat
 - A rearward-facing child seat
 - A forward-facing child seat
 - A child booster seat with a backrest and seat belt guide
- Mercedes-Benz recommends using a child booster seat with a backrest.

The child restraint system must be appropriate to the age, weight and size of the child.

Observe laws and legal requirements

Always observe the legal requirements when using a child restraint system in the vehicle.

Observe standards for child restraint systems

All child restraint systems must meet the following standards:

- U.S. Federal Motor Vehicle Safety Standards 213 and 225
- Canadian Motor Vehicle Safety Standards 213 and 210.2

Confirmation that the child restraint system complies with the standards can be found on an instruction label on the child restraint system. This confirmation can also be found in the installation instructions that are included with the child restraint system.

Detecting risks, avoiding danger

Securing systems for child restraint systems in the vehicle

Only use the following securing systems for child restraint systems:

- The LATCH-type (ISOFIX) securing rings
- The vehicle's seat belt system
- The Top Tether anchorages

Installing a LATCH-type (ISOFIX) child restraint system is preferred.

Simply attaching to the securing rings on the vehicle can reduce the risk of installing the child restraint system incorrectly.

When securing a child with the integrated seat belt of the LATCH-type (ISOFIX) child restraint system, always comply with the permissible gross weight for the child and child restraint system (→ page 67).

A booster seat may be necessary to achieve proper seat belt positioning for children over 40 lbs (18 kg) in weight or until they reach a

height where a three-point seat belt can be installed properly without a booster seat.

Mercedes-Benz recommends a suitable child booster seat with a backrest and seat belt guide.

Advantage of a rearward-facing child restraint system

It is preferable to transport a baby or a small child in a suitable rearward-facing child restraint system. In this case, the child sits in the opposite direction to the direction of travel and faces backwards.

Babies and small children have comparatively weak neck muscles in relation to the size and weight of their head. The risk of injury to the cervical spine during an accident can be reduced in a rearward-facing child restraint system.

Always secure a child restraint system correctly

⚠ WARNING Risk of injury or death due to incorrect installation of the child restraint system

The child can then not be protected or restrained as intended.

- ▶ Be sure to comply with the manufacturer's installation instructions for the child restraint system and its correct use.
- ▶ Make sure that the entire base of the child restraint system always rests on the sitting surface of the seat.
- ▶ Never place objects (e.g. cushions) under or behind the child restraint system.
- ▶ Use child restraint systems only with the original cover designed for them.
- ▶ Always replace damaged covers with genuine covers.

⚠ WARNING Risk of injury or death due to unsecured child restraint systems in the vehicle

If the child restraint system is incorrectly installed or not secured, it can come loose.

The child restraint system could be flung around and hit vehicle occupants.

- ▶ Always install child restraint systems correctly, even when not in use.
- ▶ Always comply with the child restraint system manufacturer's installation instructions.

- Always observe the child restraint system manufacturer's installation and operating instructions as well as the vehicle-specific information:
 - Installing the LATCH-type (ISOFIX) child restraint system on the rear seat (→ page 67).
 - Securing the child restraint system with the seat belt on the rear seat (→ page 71).

- Securing the child restraint system with the seat belt on the front passenger seat (→ page 72). Observe the specific instructions for the rearward-facing and forward-facing child restraint systems (→ page 72).

If the front passenger seat is occupied, ensure, both before and during the journey, that the status of the front passenger airbag is correct for the current situation (→ page 55).

- Observe the warning labels in the vehicle interior and on the child restraint system.
- Also secure Top Tether if present.

Do not modify the child restraint system

⚠ WARNING Risk of injury due to modifications to the child restraint system

The child restraint system can no longer function properly. This poses an increased risk of injury.

- ▶ Never modify a child restraint system.

- ▶ Only affix accessories which have been specially approved for this child restraint system by the child restraint system's manufacturer.

Only use child restraint systems which are in proper working condition

⚠ WARNING Risk of injury or death caused by the use of damaged child restraint systems

Child restraint systems or their retaining systems that have been subjected to stress in an accident may not be able to perform their intended protective function.

It may be the case that the child cannot be properly restrained.

- ▶ Always immediately replace child restraint systems that have been damaged or involved in an accident.
- ▶ Have the securing systems for the child restraint systems checked at a qualified specialist workshop before installing a child restraint system again.

Avoid direct sunlight

▲ WARNING Risk of burns when the child seat is exposed to direct sunlight

If the child restraint system is exposed to direct sunlight or heat, parts could heat up excessively.

Children could suffer burns from these parts, particularly the metallic parts of the child restraint system.

- ▶ Always make sure that the child restraint system is not exposed to direct sunlight.
- ▶ Cover the child restraint system with a blanket, for example.
- ▶ If the child restraint system has been exposed to direct sunlight, allow it to cool before securing a child into it.
- ▶ Never leave children unattended in the vehicle.

Observe when stopping or parking

▲ WARNING Risk of accident and injury due to children left unattended in the vehicle

If children are left unsupervised in the vehicle, they could, in particular:

- open doors, thereby endangering other persons or road users.
- get out and be struck by oncoming traffic.
- operate vehicle equipment and become trapped, for example.

In addition, the children could also set the vehicle in motion, for example by:

- releasing the parking brake.
 - changing the transmission position.
 - starting the vehicle.
- ▶ Never leave children unattended in the vehicle.

- ▶ When leaving the vehicle, always take the SmartKey with you and lock the vehicle.
- ▶ Keep the vehicle SmartKey out of reach of children.

▲ WARNING Danger to life due to exposure to extreme heat or cold in the vehicle



If people, particularly children, are exposed to extreme temperatures over an extended period of time, there is a risk of serious injury or danger to life.

- ▶ Never leave persons, children in particular, unattended in the vehicle.

Overview of suitable seats in the vehicle for installing a child restraint system

Left/right rear seat

Preferred securing system:

-  LATCH-type (ISOFIX) child seat securing system
-  Also secure Top Tether if present (→ page 69).

Alternative securing system:

-  Vehicle seat belt

Be sure to observe:

- If the rear seat is occupied, ensure, both before and during the journey, that the status of the rear airbag is correct for the current situation (→ page 59).

Front passenger seat

Securing system:



-  Vehicle seat belt

Be sure to observe:

- If the front passenger seat is occupied, ensure, both before and during the journey, that the status of the front passenger airbag is correct for the current situation (→ page 55).
- Notes on automatic front passenger airbag shutoff (→ page 53).

Center rear seat

Securing system:

-  Vehicle seat belt
-  Also secure Top Tether if present (→ page 69).

Activating or deactivating the special seat belt retractor

⚠ WARNING Risk of injury or death if a seat belt is unfastened while the vehicle is in motion

If the seat belt is released while the vehicle is in motion, the special seat belt retractor is deactivated and the child restraint system is no longer correctly secured. The seat belt is drawn in slightly by the inertia reel and cannot be immediately closed again.

- ▶ Stop the vehicle immediately in accordance with the traffic conditions.
- ▶ Activate the special seat belt retractor again and correctly secure the child restraint system.

When enabled, the special seat belt retractor ensures that the seat belts of the front passenger seat and rear seats do not slacken once the child restraint system is secured.

The seat belts on the following seats are equipped with a special seat belt retractor:

- Front passenger seat
- Rear seats

Installing a child restraint system:

- ▶ When installing a child restraint system, always observe the manufacturer's installation and operating instructions as well as the information in this Operator's Manual.
- ▶ Pull the seat belt smoothly from the seat belt outlet.
- ▶ Engage the seat belt tongue in the seat belt buckle.

Activating the special seat belt retractor:

- ▶ Pull the seat belt out fully and let the inertia reel retract it again. When the special seat belt retractor is activated, you will hear a ratcheting sound.
- ▶ Push the child restraint system down until the seat belt sits tightly.

Deactivating the special seat belt retractor:

- ▶ Press the release button of the seat belt buckle.
- ▶ Hold the seat belt tongue and guide back to the seat belt outlet.

Installing a LATCH-type (ISOFIX) child restraint system on the rear seat

Installing a LATCH-type (ISOFIX) child restraint system on the rear seat

⚠ WARNING Risk of injury or death if the permissible gross mass of the child and child restraint system together is exceeded.

Too much load may be placed on the LATCH-type (ISOFIX) child restraint system and the child may not be restrained correctly in the event of an accident, for example.

- ▶ If the child and the child restraint system together weigh more than the permissible gross mass of 73 lb (33 kg), only use a LATCH-type (ISOFIX) child

restraint system with which the child is secured with the vehicle seat belt.

- ▶ Also secure the child restraint system with the Top Tether belt, if available.

Always comply with the information about the mass of the child restraint system:

- In the manufacturer's installation and operating instructions for the child restraint system used
- On a label on the child restraint system, if present

Regularly check that the permissible gross mass of the child and child restraint system is still complied with.

When installing a child restraint system, observe the following:

- Always observe the correct use of the seats and consider their suitability for attaching a child restraint system.
- Always comply with the manufacturer's installation and operating instructions for the child restraint system used.

- ✓ Make sure that the child's feet do not touch the front seat. If necessary, move the front seat slightly forwards.
- ⓘ When installing a LATCH-type (ISOFIX) child restraint system, also observe the following:
 - ✓ **When using a baby car seat in weight group 0/0+ and a rearward-facing child restraint system in weight group I on a rear seat:** adjust the front seat so that the seat does not touch the child restraint system.
 - ✓ **When using a forward-facing child restraint system in weight group I:** remove the head restraint from the respective seat, if possible. In addition, the backrest of the child restraint system must lie as flat as possible against the backrest of the vehicle seat.
After the child restraint system has been removed, replace the head restraints again immediately and adjust them correctly.
 - ✓ If the head restraint of the child seat cannot be fully extended when it is installed in the

vehicle, this will result in restrictions on the maximum size setting for child restraint systems in weight group II or III.

Contact with the roof when the head restraint is fully extended and locked in place will not result in any restrictions on use.

- ✓ The child restraint system must not be put under strain between the roof and the seat cushion and/or be installed facing the wrong direction. Where possible, adjust the seat cushion inclination accordingly.
- ✓ The child restraint system must not be put under strain by the head restraint. Adjust the head restraints as appropriate.

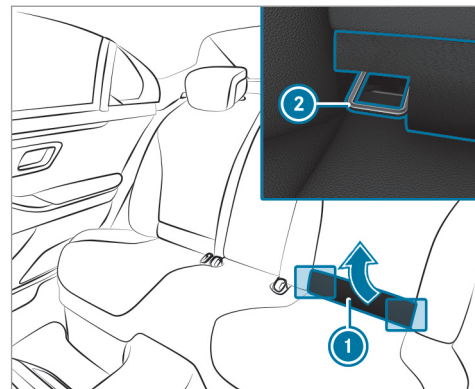

Before every journey, make sure that the LATCH-type (ISOFIX) child restraint system is engaged correctly in both mounting brackets in the vehicle.

! **NOTE** Damage to the seat belt for the center seat during installation of the child restraint system

- ▶ Make sure that the seat belt is not trapped.

- ▶ **Vehicles with reclining rear seats:** Tilt the backrest of the reclining rear seat back slightly before the LATCH-type (ISOFIX) child restraint system is installed.
- ▶ Fold upholstered lining ① upwards.
- ▶ Pull the tab on upholstered lining ① upwards and position it on the supporting surface. Upholstered lining ① will remain folded upwards.
- ▶ Attach the LATCH-type (ISOFIX) child restraint system to both mounting brackets ② in the vehicle.
- ▶ To close, fold upholstered lining ① upwards.
- ▶ Lift the tab from the support surface and slide it back into the upholstery slot between

the seat backrest and seat cushion. Close the upholstery flap.

- ▶ **Vehicles with reclining rear seats:** Return the reclining rear seat backrest to an upright position. The reclining rear seat backrest must be in contact with the child restraint system.

Securing Top Tether

! **WARNING** Risk of injury or death from adjusting the seat after installing a child restraint system

Vehicles with electrically adjustable rear bench seats:

The following may occur:

- The Top Tether belt may sit either too loose or too tight
- The child restraint system may be loose, incorrectly positioned or damaged and then not perform its intended protective function.

- ▶ Never adjust the seat after the child restraint system has been installed.



If the child restraint system is equipped with a Top Tether belt:

The risk of injury may be reduced by Top Tether. The Top Tether belt enables an additional connection between the child restraint system attached with ISOFIX and the vehicle.

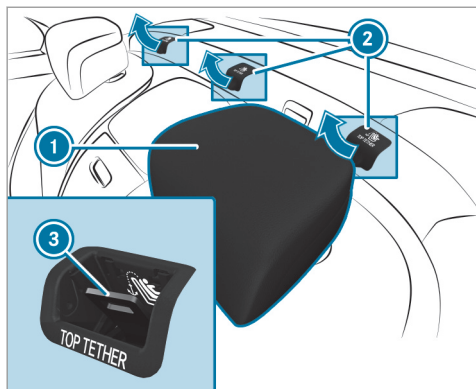

- i** Canada: Only the two outer Top Tether anchorages are available.
- ▶ If necessary, slide head restraint ① upwards (→ page 119).
- ▶ Remove cover ② of Top Tether anchorage ③.
- ▶ Install the LATCH-type (ISOFIX) child restraint system with Top Tether. In doing so, comply

with the child restraint system manufacturer's installation instructions.

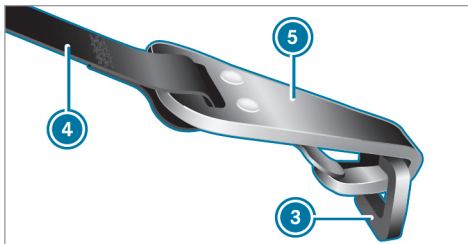

- ▶ Guide Top Tether belt ④ under head restraint ① between the two head restraint bars.
- ▶ Hook Top Tether hook ⑤ of Top Tether belt ④ into Top Tether anchorage ③ without twisting.
- ▶ Tension Top Tether belt ④. In doing so, comply with the child restraint system manufacturer's installation instructions.
- ▶ If necessary, slide head restraint ① downwards (→ page 119). Make sure that you do

not interfere with the correct routing of Top Tether belt ④.

Vehicles with rear airbags

Notes on rearward-facing and forward-facing child restraint systems on the left and right rear seat



Sticker visible when the rear door is open

When installing a child restraint system, the rear airbag can be disabled.

If using a forward-facing child restraint system with enabled rear airbag: make sure that the child's feet are not placed in front of the rear airbag cover or on the seat backrest. The child's legs can otherwise be flung upward if the rear airbag is deployed.

Enabling/disabling the rear airbag

The rear airbag can be enabled or disabled via the multimedia display (→ page 60).

Securing the child restraint system with the seat belt

Securing the child restraint system with the seat belt on the rear seat

When installing a belt-secured child restraint system, observe the following:

- ✓ Always comply with the manufacturer's installation and operating instructions for the child restraint system used.
- ✓ **When using a weight category 0/0+ baby car seat and a weight category I**

rearward-facing child restraint system on a rear seat: adjust the front seat so that the seat does not touch the child restraint system.

- ✓ **When using a weight category I forward-facing child restraint system:** remove the head restraint from the respective seat, if possible.

After the child restraint system has been removed, replace the head restraints again immediately and adjust them correctly.

- ✓ The backrest of the forward-facing child restraint system must, as far as possible, be resting on the seat backrest of the rear seat.
- ✓ If the head restraint of the child seat cannot be fully extended when it is installed in the vehicle, this will result in restrictions on the maximum size setting for child restraint systems in weight category II or III.
Contact with the roof when the head restraint is fully extended and locked in place will not result in any restrictions on use.

- ✓ The child restraint system must not be put under strain between the roof and the seat cushion and/or be installed facing the wrong direction. Where possible, adjust the seat cushion inclination accordingly.
- ✓ The child restraint system must not be put under strain by the head restraint. Adjust the head restraints as appropriate.
- ✓ Make sure that the child's feet do not touch the front seat. If necessary, move the front seat slightly forwards.

The seat belts on the following seats are equipped with a special seat belt retractor:

- Front passenger seat
- Rear seats

When enabled, the special seat belt retractor ensures that the seat belts of the front passenger seat and rear seats do not slacken once the child restraint system is secured (→ page 66).

- ▶ Install the child restraint system. The entire base of the child restraint system must always rest on the sitting surface of the rear seat.
- ▶ Always make sure that the shoulder belt strap is correctly routed from the seat belt outlet of the vehicle to the shoulder belt guide on the child restraint system. The shoulder belt strap must be routed forward from the seat belt outlet.

Notes on rearward-facing and forward-facing child restraint systems on the front passenger seat

▲ WARNING Risk of injury or fatal injury when using a rearward-facing child restraint system while the co-driver airbag is enabled

If you secure a child in a rearward-facing child restraint system on the co-driver seat and the PASSENGER AIR BAG OFF indicator lamp is off, the co-driver airbag can deploy in the event of an accident.

The child could be struck by the airbag.

- ▶ Always ensure that the co-driver airbag is disabled. The PASSENGER AIR BAG OFF indicator lamp must be lit.
- ▶ NEVER use a rearward-facing child restraint system on a seat with an ENABLED FRONT AIRBAG; DEATH or SERIOUS INJURY to the CHILD can occur.

Observe the specific instructions for the rearward-facing and forward-facing child restraint systems (→ page 72).

Always observe the status of the front passenger airbag on the PASSENGER AIR BAG OFF indicator lamp:

- When using a rearward-facing child restraint system on the front passenger seat, the front passenger airbag must always be disabled. This is only the case if the PASSENGER AIR BAG OFF indicator lamp is lit continuously (→ page 55).
- If the PASSENGER AIR BAG OFF indicator lamp is off, the front passenger airbag is enabled. The front passenger airbag may deploy during an accident.

Securing the child restraint system with the seat belt on the front passenger seat

When installing a belt-secured child restraint system on the front passenger seat, always observe the following:

- ☑ Observe the notes on rearward-facing and forward-facing child restraint systems on the front passenger seat (→ page 72).
- ☑ Observe the child restraint system manufacturer's installation and operating instructions.
- ☑ When using a forward-facing child restraint system in weight category I: remove the head restraint from the respective seat, if possible.
After the child restraint system has been removed, replace the head restraints again immediately and adjust them correctly.
- ☑ The backrest of the forward-facing child restraint system must, as far as possible, be resting on the seat backrest of the front passenger seat.
- ☑ If the head restraint of the child seat cannot be fully extended when it is installed in the

vehicle, this will result in restrictions on the maximum size setting for child restraint systems in weight category II or III.

Contact with the roof when the head restraint is fully extended and locked in place will not result in any restrictions on use.

- ☑ The child restraint system must not be put under strain between the roof and the seat cushion and/or be installed facing the wrong direction.
- ☑ The child restraint system must not be put under strain by the head restraint. Adjust the head restraints as appropriate.
- ☑ Never place objects (e.g. cushions) under or behind the child restraint system.

The seat belt on the front passenger side is equipped with a child seat safety feature.

When enabled, the child seat safety feature ensures that the seat belt does not slacken once the child seat is secured (→ page 66).

- ▶ Set the front passenger seat as far back as possible and move the seat into the highest position if possible.
- ▶ Fully retract the seat cushion length adjustment.
- ▶ Adjust the seat cushion inclination so that the front edge of the seat cushion is in the highest position and the rear edge of the seat cushion is in the lowest position.
- ▶ Set the seat backrest to the most vertical position possible.
- ▶ Install the child restraint system. The entire base of the child restraint system must always rest on the sitting surface of the front passenger seat.
- ▶ Always make sure that the shoulder belt strap is correctly routed from the seat belt outlet of the vehicle to the shoulder belt guide on the child restraint system. The shoulder belt strap must be routed forwards and downwards from the seat belt outlet.
- ▶ If necessary, adjust the seat belt outlet and the front passenger seat accordingly.

Child safety locks

Activating/deactivating the child safety lock for the rear doors

⚠ WARNING Risk of accident and injury due to children left unattended in the vehicle

If children are left unsupervised in the vehicle, they could, in particular:

- open doors, thereby endangering other persons or road users.
- get out and be struck by oncoming traffic.
- operate vehicle equipment and become trapped, for example.

In addition, the children could also set the vehicle in motion, for example by:

- releasing the parking brake.
- changing the transmission position.
- starting the vehicle.

- ▶ Never leave children unattended in the vehicle.
- ▶ When leaving the vehicle, always take the SmartKey with you and lock the vehicle.
- ▶ Keep the vehicle SmartKey out of reach of children.

⚠ WARNING Danger to life due to exposure to extreme heat or cold in the vehicle

If people, particularly children, are exposed to extreme temperatures over an extended period of time, there is a risk of serious injury or danger to life.

- ▶ Never leave persons, children in particular, unattended in the vehicle.

⚠ WARNING Risk of accident and injury due to children left unattended in the vehicle

If children are traveling in the vehicle, they could, in particular:

- Open doors, thereby endangering other persons or road users
- Get out and be struck by oncoming traffic
- Operate vehicle equipment and become trapped, for example

- ▶ Always activate the child safety locks installed if children are traveling in the vehicle.
- ▶ Never leave children unattended in the vehicle.
- ▶ When leaving the vehicle, always take the SmartKey with you and lock the vehicle.

There are child safety locks for the rear doors and the rear side windows.

The child safety lock on the rear doors secures each door separately. The doors can no longer be opened from the inside.

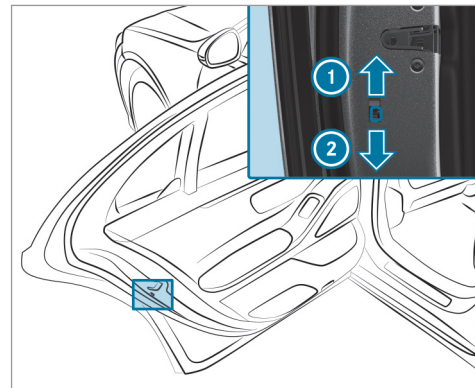

- ▶ Press the lever in direction ① (activate) or ② (deactivate).
- ▶ Make sure that the child safety locks are working properly.

Activating/deactivating the child safety lock for the rear side windows

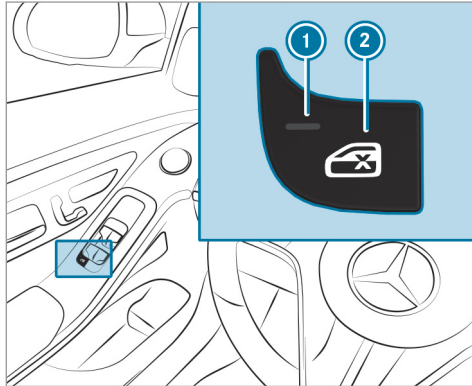

▶ **To activate/deactivate:** press button ②.

The rear side window can be opened or closed as follows:

- Indicator lamp ① is lit: via the switch on the driver's door

- Indicator lamp ① is off: via the switch on the corresponding rear door or driver's door

When the child safety lock is activated, the controls in the rear passenger compartment are disabled for:

- The rear side windows
- The adjustment of the front passenger seat from the rear passenger compartment
- The rear seat belt extender
- The roller sunblinds:
 - Of the rear side windows
 - Of the rear window
 - In the roof

Notes on pets in the vehicle

⚠ WARNING Risk of accident and injury due to animals left unsecured or unattended in the vehicle

If you leave animals in the vehicle unattended or unsecured, they could possibly press buttons or switches.

An animal may:

- Activate vehicle equipment and become trapped, for example
- Switch systems on or off and endanger other road users

Unsecured animals may be thrown around in the vehicle in the event of an accident or sudden steering and braking maneuvers and injure vehicle occupants in the process.

- ▶ Never leave animals in the vehicle unattended.
- ▶ Always correctly secure animals while driving, e.g. using a suitable animal carrier.

SmartKey

Overview of SmartKey functions

⚠ WARNING Risk of accident and injury due to children left unattended in the vehicle

If children are left unsupervised in the vehicle, they could, in particular:

- open doors, thereby endangering other persons or road users.
- get out and be struck by oncoming traffic.
- operate vehicle equipment and become trapped, for example.

In addition, the children could also set the vehicle in motion, for example by:

- releasing the parking brake.
- changing the transmission position.
- starting the vehicle.

▶ Never leave children unattended in the vehicle.

- ▶ When leaving the vehicle, always take the SmartKey with you and lock the vehicle.
- ▶ Keep the vehicle SmartKey out of reach of children.

! NOTE Damage to the SmartKey caused by magnetic fields



- ▶ Keep the SmartKey away from strong magnetic fields.



Vehicle SmartKey with panic alarm

- ① Opens/closes the trunk lid

- ② Unlocks (with embossed surface)
- ③ Locks
- ④ Indicator lamp
- ⑤ Panic alarm

i If indicator lamp ④ does not light up after pressing the  or  button, the battery is weak or possibly discharged. Replace the battery as soon as possible.

Replace the SmartKey battery (→ page 78).

The SmartKey locks and unlocks the following components:

- Doors
- Fuel filler flap
- Trunk lid

If the vehicle is not opened within approximately 40 seconds after unlocking, it locks again. Anti-theft protection is armed again.

Do not keep the SmartKey together with electronic devices or metal objects. This can affect the SmartKey's functionality.

Indicator lamp of the vehicle locking system

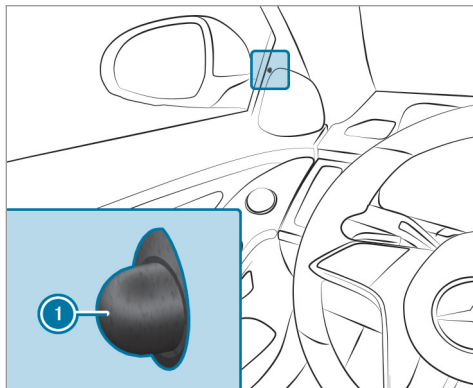

Indicator lamp ❶ in the trim on the driver's side flashes when the vehicle is locked from outside.

In the following cases, indicator lamp ❶ remains off:

- When the vehicle is locked from inside
- Whilst driving

Activating/deactivating the acoustic locking verification signal

Multimedia system:

- ➔ ➔ Settings ➔ Vehicle
- ➔ Opening/closing

- ▶ Activate or deactivate Acoustic Lock.

Activating/deactivating the panic alarm

Requirements:

- The ignition is switched off.



- ▶ **To activate:** press button ❶ for approximately one second. A visual and audible alarm is triggered.
 - ▶ **To deactivate:** briefly press button ❶ again.
- or
- ▶ Press the start/stop button on the cockpit, with the SmartKey inside the vehicle.

Changing the unlocking settings

Possible unlocking functions of the SmartKey:

- Central unlocking
 - Unlocking the driver's door and fuel filler flap
- ▶ **To switch between settings:** press the and buttons simultaneously for approximately six seconds until the indicator lamp flashes twice.

Options if the unlocking function for the driver's door and fuel filler flap has been selected:

- **To unlock the vehicle centrally:** press the button twice.
- **Vehicles with KEYLESS-GO:** if you touch the inner surface of the door handle on the

driver's door, only the driver's door and fuel filler flap are unlocked.

Deactivating the function of the SmartKey

Vehicles with KEYLESS-GO: If you deactivate the function of the SmartKey, the KEYLESS-GO functions are also deactivated. Access or drive authorization by KEYLESS-GO is then no longer possible with that particular SmartKey. Activate the function of the SmartKey so that all its functions will again be available.

You can also deactivate the function of the SmartKey to reduce the energy consumption of the SmartKey if you do not use the vehicle or a SmartKey for an extended period of time.

▶ **To deactivate:** press the  button on the SmartKey twice in quick succession. The SmartKey indicator lamp flashes twice briefly and lights up once.

▶ **To activate:** press any button on the SmartKey.

ⓘ When the vehicle is started with the SmartKey in the marked space of the center con-

sole, the function of the SmartKey is automatically activated (→ page 190).

Removing/inserting the emergency key

Removing the emergency key

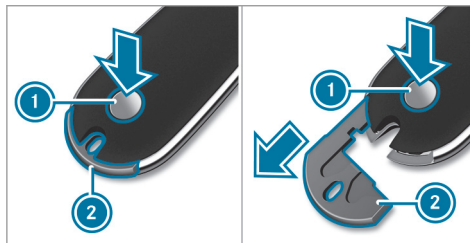

- ▶ Press release button ①.
- ▶ Emergency key ② is pushed out slightly.
- ▶ Fully remove emergency key ②.

Inserting the emergency key

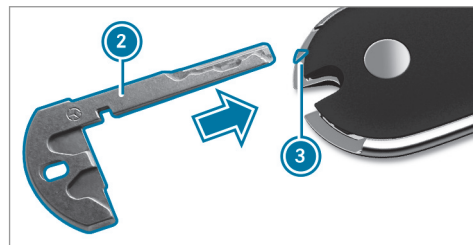

- ▶ Insert emergency key ② at marking ③ until it engages.
- ⓘ You can use emergency key ② to attach the SmartKey to a key ring.

Replacing the SmartKey battery

⚠ DANGER Risk of fatal injuries due to swallowing batteries

Batteries contain toxic and corrosive substances. Swallowing batteries may cause

severe internal burns to occur within two hours.

There is a risk of fatal injury.

- ▶ Keep batteries out of the reach of children.
- ▶ If the cover and/or cap of the battery compartment does not close securely, do not use the SmartKey any longer and keep out of the reach of children.
- ▶ If batteries are swallowed, seek medical attention immediately.

 **ENVIRONMENTAL NOTE** Environmental damage due to improper disposal of batteries



Batteries contain pollutants. It is illegal to dispose of them with the household rubbish.



Dispose of batteries in an environmentally responsible manner. Take discharged batteries to a qualified specialist workshop or to a collection point for used batteries.

Requirements:

- You require a CR 2032 3 V cell battery.

Mercedes-Benz recommends that you have the battery replaced at a qualified specialist workshop.

- ▶ Remove the emergency key (→ page 78).

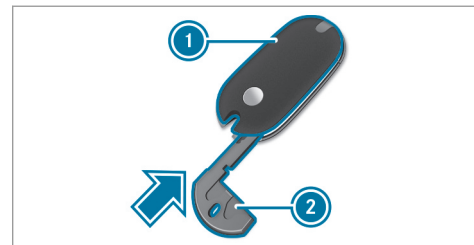

- ▶ Press emergency key (2) into the opening in the SmartKey in the direction of the arrow until cover (1) opens. When doing so, do not hold cover (1) closed.

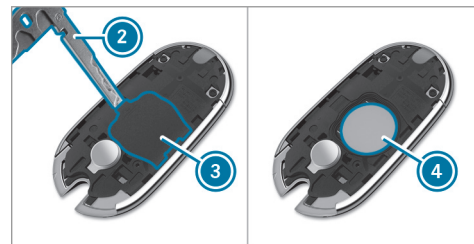

- ▶ Insert emergency key ② into the opening and lift up covering ③ and remove it.
- ▶ Repeatedly tap the SmartKey against your palm until battery ④ falls out of the SmartKey.
- ▶ Insert the new battery with the positive pole facing upwards. Use a lint-free cloth to do so.
- ▶ Make sure that the surface of the battery is free of lint, grease and other impurities.
- ▶ Insert the front tabs of covering ⑤ into the housing and then press on both sides to close it.
- ▶ Make sure that covering ③ is completely closed.
- ▶ Insert the front tabs of cover ① into the housing and then press until it is completely closed.
- ▶ Insert the emergency key again (→ page 78).

Problems with the SmartKey, troubleshooting

You can no longer lock or unlock the vehicle

Possible causes:

- The SmartKey battery is weak or discharged.
- ▶ Check the battery using the indicator lamp (→ page 76).
- ▶ Replace the SmartKey battery, if necessary (→ page 78).
- ▶ Use the replacement SmartKey.
- ▶ Use the emergency key to lock or unlock (→ page 84).
- ▶ Have the SmartKey checked at a qualified specialist workshop.

There is interference from a powerful radio signal source

Possible causes if the function of the SmartKey is impaired:

- High voltage power lines
- Mobile phones
- Electronic devices (notebooks, tablets)

- Shielding due to metal objects or induction loops for electrical gate systems or automatic barriers

- ▶ Make sure that there is sufficient distance between the SmartKey and the potential source of interference.

You have lost a SmartKey

- ▶ Have the SmartKey deactivated at a qualified specialist workshop.
- ▶ If necessary, have the mechanical lock replaced as well.

Doors

Unlocking/opening the doors from the inside

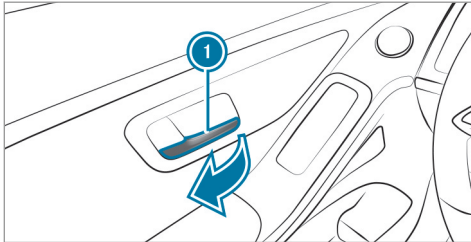

- ▶ **To unlock and open a front door:** pull door handle ①.
- ▶ **To unlock a rear door:** pull the rear door handle.
- ▶ **To open a rear door:** pull the rear door handle again.

Centrally locking and unlocking the vehicle from the inside

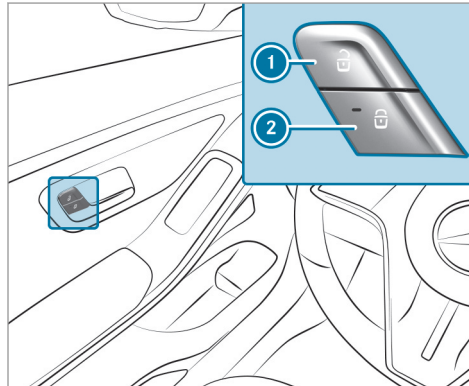

- ▶ **To unlock:** press button ①.
 - ▶ **To lock:** press button ②. The red indicator lamp on button ② lights up once the vehicle is locked.
- ① The buttons are also on the front passenger and rear doors.

This does not lock or unlock the fuel filler flap. The vehicle is not unlocked:

- If you have locked the vehicle using the SmartKey.
- If you have locked the vehicle using KEY-LESS-GO.

Locking/unlocking the vehicle with KEY-LESS-GO

Requirements:

- The SmartKey is outside the vehicle.
- The distance between the SmartKey and the vehicle does not exceed 3 ft (1 m).
- The driver's door and the door on which the door handle is used are closed.

The door handles are extended when:

- The vehicle is unlocked
- The vehicle SmartKey is detected
- A door is opened

The door handles retract:

- When the vehicle is locked

82 Opening and closing

- When pulling away
- After waiting for a time

NOTE Damage to the vehicle caused by unintentionally opening the trunk lid or a door

- When using an automatic car wash
- When using a high pressure cleaner

▶ Deactivate the function of the SmartKey in these situations.

or

▶ Make sure that the SmartKey is at a minimum distance of 10 ft (3 m) (power washer) or 20 ft (6 m) (automatic car wash) away from the vehicle.

Observe the notes:

- On washing the vehicle in a car wash (→ page 343)
- On using a high pressure cleaner (→ page 344)

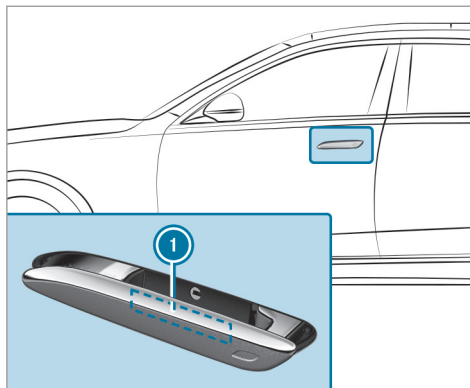

▶ **To unlock the vehicle:** touch the inner surface of door handle ①.

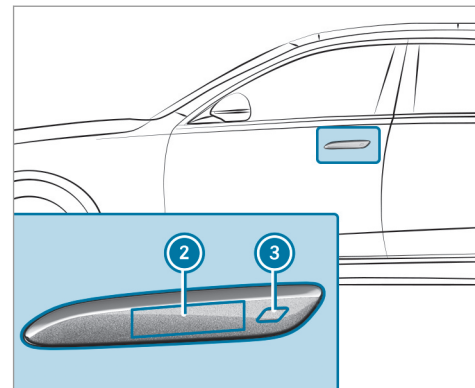

ⓘ If the door handle is not extended, touch sensor surface ② to unlock.

▶ **To lock the vehicle:** touch recessed sensor surface ③.

▶ **Convenience closing:** touch recessed sensor surface ③ for an extended period.

ⓘ Further information on convenience closing (→ page 94).

Problems with KEYLESS-GO, troubleshooting

You can no longer lock or unlock the vehicle using KEYLESS-GO

Possible causes:

- The function of the SmartKey has been deactivated.
- The SmartKey battery is weak or discharged.
- ▶ Activate the function of the SmartKey (→ page 78).
- ▶ Check the battery using the indicator lamp (→ page 76).
- ▶ Replace the SmartKey battery, if necessary (→ page 78).
- ▶ Use the replacement SmartKey.
- ▶ Use the emergency key to lock or unlock (→ page 84).
- ▶ Have the vehicle and SmartKey checked at a qualified specialist workshop.

There is interference from a powerful radio signal source

Possible causes if the function of KEYLESS-GO is impaired:

- High voltage power lines
- Mobile phones
- Electronic devices (notebooks, tablets)
- Shielding due to metal objects or induction loops for electrical gate systems or automatic barriers
- ▶ Make sure that there is sufficient distance between the SmartKey and the potential source of interference.

Activating or deactivating the automatic locking feature

Multimedia system:

- ➔  ▶ Settings ▶ Vehicle
- ▶▶ Locking Function

- ⓘ The vehicle is locked automatically when the ignition is switched on and the wheels are turning faster than walking pace.

- ▶ Switch **Automatic Door Lock** on or off.

In the following situations, there is a danger of being locked out when the function is activated:

- The vehicle is being towed or pushed.
- If the vehicle is being tested on a roller dynamometer.

Power closing function

⚠ WARNING Risk of becoming trapped when the doors close automatically

Body parts or objects can become trapped, causing injuries.

- ▶ Ensure that no body parts or objects are in the closing area.
- ▶ Automatic closing of the doors can be canceled by pulling the outer or inner door handle.

If you push the door into the lock to the first detent position, the power closing function will automatically pull the door into the lock.

- ⓘ If the vehicle is locked from the outside, or while pulling away, an automatic closing of the doors can be triggered.

Locking/unlocking the vehicle with the emergency key

Unlocking a left-hand vehicle door with the emergency key Vehicles without KEYLESS-GO

- ▶ Remove the emergency key (→ page 78).

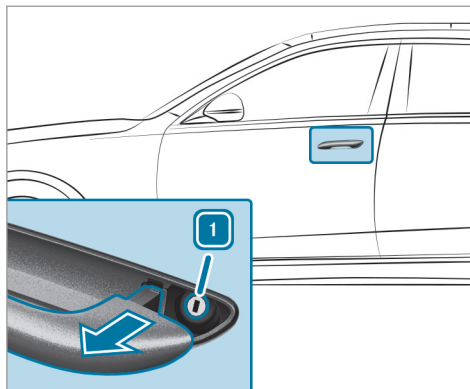

- ▶ Pull and hold the door handle.
- ▶ Insert the emergency key into the lock cylinder.
- ▶ Turn the emergency key counter-clockwise to position 1.
- ▶ Remove the emergency key and release the door handle.

Vehicles with KEYLESS-GO

- ▶ Remove the emergency key (→ page 78).

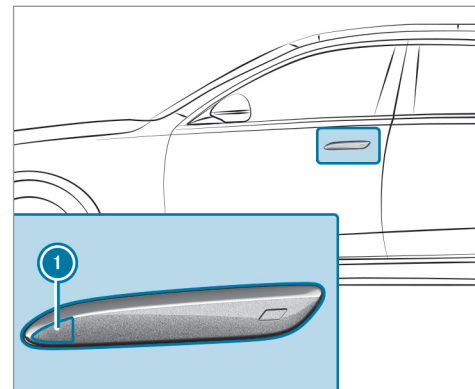

- ▶ **If the door handle is retracted:** press the front area of door handle 1. The door handle folds slightly outward.
- ▶ Pull and hold the door handle.

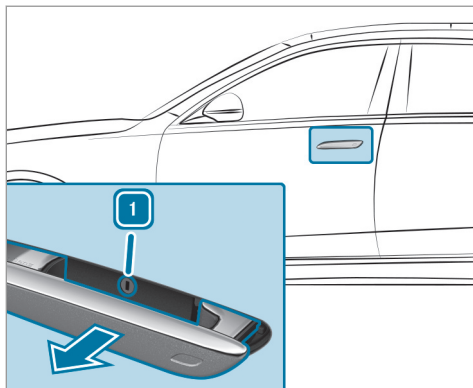

- ▶ **If the door handle is extended:** slightly pull and hold the door handle.
- ▶ Insert the emergency key into the lock cylinder.
- ▶ Turn the emergency key counter-clockwise to position 1.
- ▶ Remove the emergency key and release the door handle.

Locking the doors

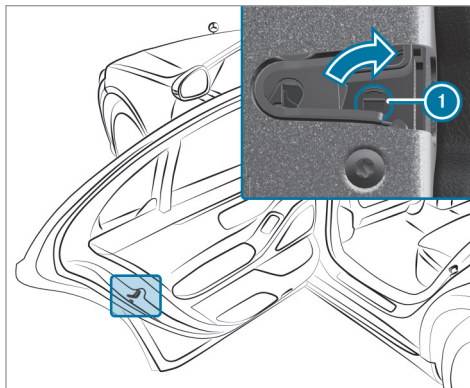

- ▶ Insert a suitable object, e.g. the emergency key, into opening 1 on the door lock.
- ▶ **To lock the left-hand side of the vehicle:** turn the emergency key clockwise as far as it will go.

- ▶ **To lock the right-hand side of the vehicle:** turn the emergency key counter-clockwise as far as it will go.

If the locked door is then closed, it can no longer be opened from the outside.

Trunk

Opening the trunk lid

⚠ DANGER Risk of exhaust gas poisoning

Combustion engines emit poisonous exhaust gases such as carbon monoxide. Exhaust gases can enter the vehicle interior if the trunk lid is open when the engine is running, especially if the vehicle is in motion.

- ▶ Always switch off the engine before opening the trunk lid.
- ▶ Never drive with the trunk lid open.

NOTE Damage to the trunk lid by obstacles above the vehicle

The trunk lid swings upwards when it is opened.

▶ Therefore, make sure that there is sufficient clearance above the trunk lid.

▶ Pull the trunk lid handle.

▶ **Vehicles with HANDS-FREE ACCESS:** Make a kicking movement with your foot below the bumper (→ page 89).

Vehicles with trunk lid convenience closing

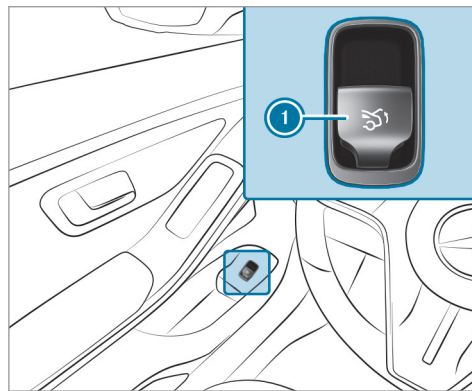

- ▶ Pull trunk lid remote operating switch ①.
- ▶ Press and hold the  button on the SmartKey.
- ▶ If the trunk lid is stopped in an intermediate position, pull it up. Release it as soon as it begins to open.

▶ With the trunk lid opening height restriction activated, manually pull the stopped trunk lid up.

If an obstacle obstructs the trunk lid during the automatic opening process, blockage detection will stop the trunk lid. The automatic blockage detection function is only an aid and is not a substitute for your attentiveness.

Closing the trunk lid

WARNING Risk of injury from unsecured items in the vehicle

If objects, luggage or loads are not secured or not secured sufficiently, they could slip, tip over or be thrown around and thereby hit vehicle occupants.

There is a risk of injury, particularly in the event of sudden braking or a sudden change in direction.

▶ Always stow objects in such a way that they cannot be thrown around.

- ▶ Before the journey, secure objects, luggage or loads against slipping or tipping over.

Observe the notes on loading the vehicle.

Notes on closing the trunk lid: your vehicle is equipped with automatic SmartKey recognition. If a SmartKey belonging to the vehicle is detected in the vehicle, the trunk lid will not be locked and will pop open again.

Note that the trunk lid will not be locked if the following situation occurs:

- You have locked the vehicle and close the trunk lid while a SmartKey belonging to the vehicle is inside the vehicle.
and
- A second SmartKey belonging to the vehicle is not detected outside the vehicle.

Automatic SmartKey recognition is only an aid and is not a substitute for your attentiveness.

- ▶ Before locking, ensure that at least one SmartKey belonging to the vehicle is outside the vehicle.

- ▶ **To close the trunk lid:** pull the trunk lid down using the handle recess and push it closed.

- ⓘ If you lightly push the trunk lid closed, the power closing function will automatically pull the trunk lid into the lock.

Vehicles with trunk lid convenience closing

- ⚠ **WARNING** Risk of becoming trapped during automatic closing of the trunk lid

Parts of the body could become trapped. There may be people in the closing area.

- ▶ Make sure that nobody is in the vicinity of the closing area.
- ▶ Use one of the following options to stop the closing process:
 - Press the  button on the SmartKey.
 - Press or pull the remote operating switch on the driver's door.
 - Press the closing or locking button on the trunk lid.

- ▶ • Pull the trunk lid handle.

Vehicles with HANDS-FREE ACCESS: it is also possible to stop the closing process by making a kicking movement below the rear bumper.

- ▶ Pull the trunk lid handle. Release it as soon as it begins to close.
- ▶ If the trunk lid is stopped in an intermediate position, push it down. The trunk lid will continue to close.

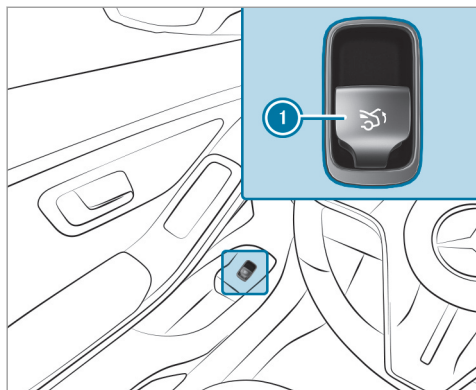

- ▶ Press trunk lid remote operating switch ①.

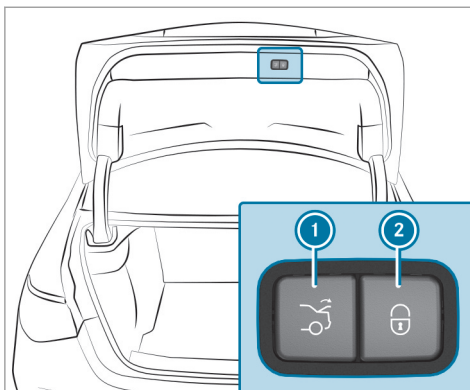

- ▶ Press closing button ① on the trunk lid.

Vehicles with KEYLESS-GO

- ▶ Press locking button ② on the trunk lid. If a SmartKey is detected outside the vehicle, the trunk lid will close and the vehicle will be locked.
- ▶ With the trunk lid completely open, press and hold the  button on the SmartKey. The

SmartKey must be in the vicinity of the vehicle.

Vehicles with HANDS-FREE ACCESS

- ▶ With the trunk lid completely open, make a kicking movement with your foot below the bumper (→ page 89).

Trunk lid automatic reversing function

The trunk lid is equipped with automatic blockage detection with a reversing function. If an obstacle obstructs the trunk lid during the automatic closing process, it will automatically open again. The automatic reversing function is only an aid and is not a substitute for your attentiveness.

- ▶ During the closing process, make sure that no body parts are in the closing area.

⚠ WARNING Risk of becoming trapped despite reversing function

The reversing function will not react:

- to soft, light and thin objects, e.g. fingers
- towards the end of the closing procedure

In these situations in particular, the reversing function cannot prevent someone being trapped.

- ▶ Ensure that no body parts are in the closing area.
- ▶ If someone is trapped, use one of the following options:
 - Press the  button on the SmartKey.
 - Press the remote operating switch on the driver's door.
 - Press the closing or locking button on the trunk lid.
 - Pull the trunk lid handle.

HANDS-FREE ACCESS function

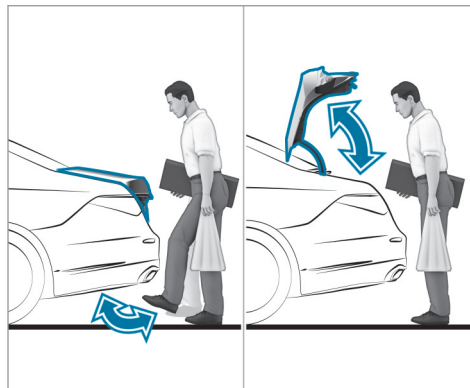

With HANDS-FREE ACCESS you can open, close or interrupt trunk lid movement by performing a kicking movement under the rear bumper.

The kicking movement triggers the opening or closing process alternately.

Observe the notes when opening (→ page 85) and closing (→ page 86) the trunk lid.

- ⓘ A warning tone sounds while the trunk lid is opening or closing.

⚠ WARNING Risk of burns caused by a hot exhaust system

The vehicle exhaust system can become very hot. If you use HANDS-FREE ACCESS, you could burn yourself by touching the exhaust system.

- ▶ Always ensure that you only make a kicking movement within the detection range of the sensors.

! **NOTE** Damage to the vehicle caused by unintentionally opening the trunk lid or a door

- When using an automatic car wash
- When using a high pressure cleaner
- ▶ Deactivate the function of the SmartKey in these situations.

or

- ▶ Make sure that the SmartKey is at a minimum distance of 10 ft (3 m) (power washer) or 20 ft (6 m) (automatic car wash) away from the vehicle.

When making the kicking movement, make sure that you are standing firmly on the ground. You could otherwise lose your balance, e.g. on ice.

Observe the following notes:

- The SmartKey is behind the vehicle.
- Stand at least 12 in (30 cm) away from the vehicle while performing the kicking movement.
- Do not come into contact with the bumper while making the kicking movement.
- Do not carry out the kicking movement too slowly.
- The kicking movement must be towards the vehicle and back again.

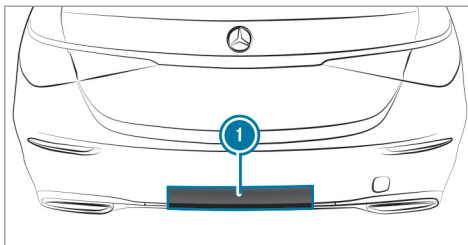

① Detection range of the sensors

If several consecutive kicking movements are not successful, wait ten seconds.

System limits

The system may be impaired or may not function in the following cases:

- The sensors are dirty, e.g. due to road salt or snow.
- The kicking movement is made using a prosthetic leg.

The trunk lid could be opened or closed unintentionally, in the following situations:

- A person's arms or legs are moving in the sensor detection range, e.g. when polishing the vehicle or picking up objects.
- Objects are moved or placed behind the vehicle, e.g. tensioning straps or luggage.
- Clamping straps, tarps or other coverings are pulled over the bumper.
- A protective mat with a length reaching over the trunk sill down into the detection range of the sensors is used.
- The protective mat is not secured correctly.

Deactivate the function of the SmartKey (→ page 78) or do not carry the SmartKey about your person in such situations.

Switching separate trunk locking on and off

Multimedia system:

- [Home] → Settings → Vehicle
- Opening/closing

Switching separate trunk locking on

- ▶ Select **Block Trunk Access**.
- ▶ Create a PIN.
- ▶ Press **OK** to confirm the PIN.
- ▶ Enter the PIN again and confirm it.
The trunk will remain locked if you unlock the vehicle centrally.
- ⓘ If an accident has been detected, the trunk will unlock even if separate locking is switched on.
- ⓘ You can open the trunk with the emergency key even while trunk lock is active. Separate trunk locking will remain active.

Switching separate trunk locking off

- ▶ Select **Block Trunk Access**.

- ▶ Enter the PIN.
If the PIN is correct, separate trunk locking will be switched off and the PIN deleted.

Resetting the PIN

If you have forgotten the PIN, you can switch off separate trunk locking with the emergency key.

- ▶ Select **Block Trunk Access**.
- ▶ Confirm **Forget PIN?**.
- ▶ Unlock the trunk within three minutes with the emergency key.
Separate trunk locking will be switched off and the PIN deleted.

Unlocking and opening the trunk from inside with the emergency release

Requirements:

- The 12 V vehicle battery is connected and charged.

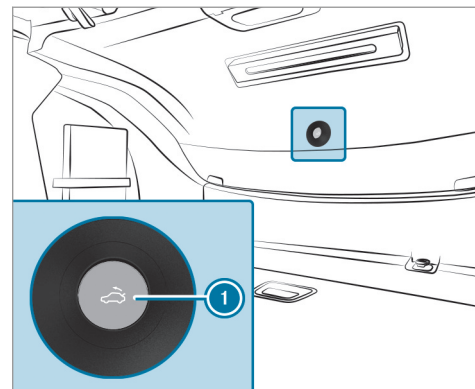

- ▶ Press emergency release button ① briefly.

Unlocking the trunk lid using the emergency key

- ▶ Take the emergency key out of the SmartKey (→ page 78).
- ▶ Insert the emergency key into the trunk lock as far as it will go.

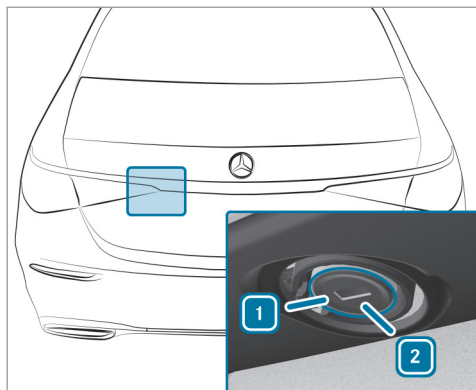

- ▶ Turn the emergency key counter-clockwise from position **1** to position **2**.
- ▶ Turn the emergency key back to position **1** and remove it.
- i** If you use the emergency key to unlock and open the trunk lid, the anti-theft alarm system will be triggered.

Activating/deactivating the trunk lid opening height restriction

Multimedia system:

- ▶ ▶ Settings ▶ Vehicle
- ▶ ▶ Opening/closing

- ▶ Activate or deactivate the **Opening Height Limiter**.

This function prevents the trunk lid from hitting a low garage ceiling, for example.

Side windows

Opening and closing the side windows

- ⚠ WARNING** Risk of entrapment when opening a side window

When opening a side window, parts of the body could be drawn in or become trapped between the side window and window frame.

- ▶ When opening, make sure that nobody is touching the side window.

- ▶ If someone is trapped, release the button immediately or pull it in order to close the side window again.

- ⚠ WARNING** Risk of becoming trapped when closing a side window

When closing a side window, body parts could be trapped in the closing area in the process.

- ▶ When closing, make sure that no body parts are in the closing area.
- ▶ If someone is trapped, release the button immediately or press the button in order to reopen the side window.

- ⚠ WARNING** Risk of becoming trapped when children operate the side windows

Children could become trapped if they operate the side windows, particularly when unattended.

- ▶ Activate the child safety lock for the rear passenger compartment side windows.
- ▶ When leaving the vehicle, always take the SmartKey with you and lock the vehicle.
- ▶ Never leave children unattended in the vehicle.

Requirements:

- The power supply or the ignition is switched on.

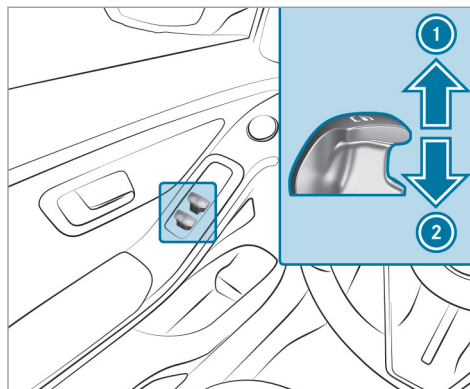

- ① Closing
- ② Opening

The buttons on the driver's door take precedence.

- ▶ **To start automatic operation:** press the  button beyond the point of resistance or pull and release it.

- ▶ **To interrupt automatic operation:** press or pull the  button again.

When the vehicle is switched off, you can continue to operate the side windows.

This function is available for around four minutes or until a front door is opened.

- ① **Vehicles with electric roller sunblinds on rear doors on the left and right:** The buttons for the rear side windows also open and close the roller sunblinds (→ page 101).

Automatic reversing function of the side windows

If an obstacle impedes a side window during the closing process, the side window will open again automatically. The automatic reversing function is only an aid and is not a substitute for your attentiveness.

- ▶ During the closing process, make sure that no body parts are in the closing area.

⚠ WARNING Risk of becoming trapped despite there being reversing protection on the side window

The reversing function does not react:

- To soft, light and thin objects, e.g. fingers.
- During resetting.

The reversing function cannot prevent someone from becoming trapped in these situations.

- ▶ During the closing process, make sure that no body parts are in the closing area.
- ▶ If someone becomes trapped, press the  button to open the side window again.

Convenience opening (ventilating the vehicle before starting a journey)

⚠ WARNING Risk of entrapment when opening a side window

When opening a side window, parts of the body could be drawn in or become trapped between the side window and window frame.

- ▶ When opening, make sure that nobody is touching the side window.
- ▶ Release the button immediately if somebody becomes trapped.

- ▶ Press and hold the  button on the SmartKey.

The following functions are performed:

- The vehicle is unlocked.
- The side windows are opened.
- The panoramic sliding roof is opened.
- The seat ventilation of the driver's seat is switched on.

ⓘ If the roller sunblinds of the panoramic sliding sunroof are closed, the roller sunblinds are opened first.

ⓘ If the roller sunblinds of the rear doors are closed, the roller sunblinds are opened first.

▶ **To interrupt convenience opening:** release the  button.

▶ **To continue convenience opening:** press and hold the  button again.





Convenience closing (closing the vehicle from outside)

⚠ WARNING Risk of entrapment due to not paying attention during convenience closing

When the convenience closing feature is operating, parts of the body could become trapped in the closing area of the side window and the sliding sunroof.

- ▶ When the convenience closing feature is operating, monitor the entire closing

process and make sure that no body parts are in the closing area.

- ▶ Press and hold the  button on the SmartKey.
- The following functions are performed:
- The vehicle is locked.
 - The side windows are closed.
 - The panoramic sliding roof is closed.
- ▶ **To interrupt convenience closing:** release the  button.
 - ▶ **To continue convenience closing:** press and hold the  button again.
-  Convenience closing also functions with KEYLESS-GO (→ page 81).

Resolving problems with the side windows

 **WARNING** Risk of becoming trapped or fatally injured if reversing protection is not activated

If you close a side window again immediately after it has been blocked, the side window will close with increased or maximum force. The reversing function is then not active and body parts may become trapped.

- ▶ Make sure that no parts of the body are in the closing area.
- ▶ To stop the closing process, release the button or press the button again to reopen the side window.

A side window cannot be closed and you cannot see the cause.

- ▶ Check to see whether any objects are in the window guide.
- ▶ Adjust the side windows.

Adjusting the side windows

If a side window is obstructed during closing and reopens again immediately:

- ▶ Immediately after this, pull and hold the corresponding button again until the side window has closed and hold the button for at least one more second (re-adjustment). The side window will be closed without the automatic reversing function.

If the side window is obstructed again and reopens again immediately:

- ▶ Immediately after this, pull and hold the corresponding button again until the side window has closed and hold the button for at least one more second (follow-up adjustment). The side window will be closed without the automatic reversing function.

The side windows cannot be opened or closed using the convenience opening feature.

Possible causes:

- The SmartKey battery is weak or discharged.

- ▶ Check the battery using the indicator lamp (→ page 76).
- ▶ Replace the SmartKey battery, if necessary (→ page 78).

Sliding sunroof

Opening and closing the sliding sunroof

- ❗ The term "sliding sunroof" refers to the panorama roof with power tilt/sliding panel.

⚠ WARNING Risk of becoming trapped when the sliding sunroof is being opened and closed

Body parts may become trapped in the range of movement.

- ▶ During the opening and closing process, make sure that no body parts are in the sweep of the sliding sunroof.
- ▶ If someone is trapped, release the control panel immediately.

or

- ▶ Touch the control panel during automatic operation.
The opening/closing process will be stopped.

⚠ WARNING Risk of becoming trapped if the sliding sunroof is operated by children

Children operating the sliding sunroof could get caught in the moving parts, particularly if unattended.

- ▶ Never leave children unattended in the vehicle.
- ▶ When leaving the vehicle, always take the key with you and lock the vehicle.

⚠ WARNING Risk of becoming trapped when the roller sunblind is being opened and closed

Body parts may become trapped between the roller sunblind and frame or sliding roof.

- ▶ During the opening or closing process, make sure that no body parts are in the roller sunblind's range of movement.
- ▶ If someone is trapped, release the control panel immediately.

or

- ▶ Touch the control panel during automatic operation.
The opening/closing process will be stopped.

! NOTE Malfunction due to snow and ice
Snow and ice may cause the sliding sunroof to malfunction.

- ▶ Open the sliding sunroof only if it is free of snow and ice.

! NOTE Damage caused by protruding objects

Objects that protrude from the sliding sunroof may damage the sealing strips.

- ▶ Do not allow anything to protrude from the sliding sunroof.

! **NOTE** Damage to panorama roof with power tilt/sliding panel caused by roof luggage rack

If the panorama roof with power tilt/sliding panel is opened when a roof luggage rack is installed, the panorama roof with power tilt/sliding panel may be damaged by the roof luggage rack.

- ▶ Do not open the panorama roof with power tilt/sliding panel if a roof luggage rack is installed.

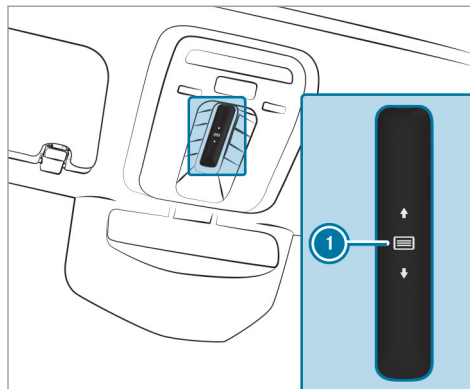

The sliding sunroof and the front roller sunblind are operated using control panel ①.

The panorama roof with power tilt/sliding panel can be operated only when the roller sunblind is open.

- ▶ **To open:** swipe backwards across control panel ① and hold.

- ▶ **To close:** swipe forwards across control panel ① and hold.
- ▶ **To raise or lower:** press control panel ① briefly.
- ▶ **To start automatic operation:** swipe forwards or backwards across control panel ①.
- ▶ **To cancel automatic operation:** press control panel ① again. The opening/closing process will be stopped.

Operating the rear passenger compartment roller sunblind from the front

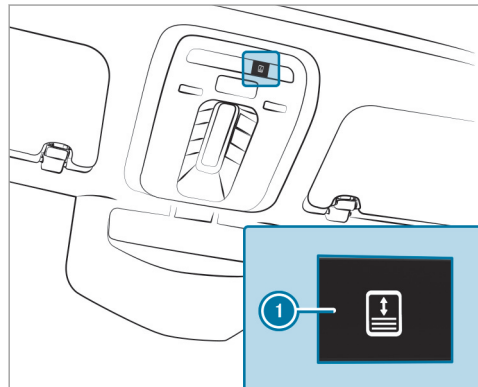

- ▶ **To open or close:** press button ①.
- ▶ **To stop:** press button ① again.

If you stop the opening or closing process, the roller sunblind will first be closed again when the process is resumed.

Operating the rear roller sunblind from the rear passenger compartment

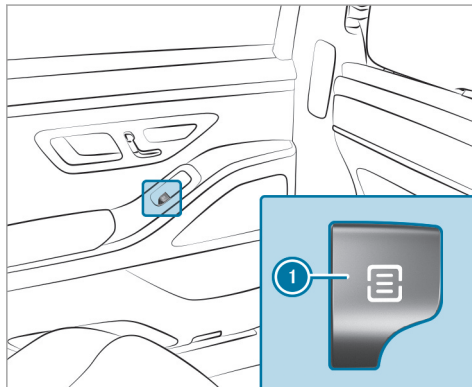

- ▶ **To open/close manually:** push or pull button ① to the point of resistance and hold it until the roller sunblind has reached the desired position.
- ▶ **To open/close fully:** push or pull button ① beyond the point of resistance and release it.

Automatic reversing function of the sliding sunroof

If an obstacle obstructs the sliding sunroof during the closing process, the sliding sunroof will open again automatically. The automatic reversing function is only an aid and is not a substitute for your attentiveness.

- ▶ During the closing process, make sure that no body parts are in the closing area.

⚠ WARNING Risk of becoming trapped despite reversing function

The reversing function will not react:

- To soft, light and thin objects, e.g. fingers.
- Towards the end of the closing procedure.
- During resetting.

- ▶ During the closing process, make sure that no body parts are in the closing area.
- ▶ If someone is trapped, release the control panel immediately.

or

- ▶ Touch the control panel during automatic closing.
The closing process will be stopped.

Automatic reversing function of the roller sunblinds

If an obstacle obstructs a roller sunblind during the closing process, the roller sunblind will open again automatically. The automatic reversing function is only an aid and is not a substitute for your attentiveness.

- ▶ When closing the roller sunblinds, make sure that no body parts are in the range of movement.

⚠ WARNING Risk of becoming trapped despite reversing function

In particular, the reversing function does not react to soft, light and thin objects, e.g. fingers.

- ▶ When closing the roller sunblind, make sure that no body parts are in the range of movement.

- ▶ If someone is trapped, release the control panel immediately.

or

- ▶ Touch the control panel during automatic closing.
The closing process will be stopped.

Automatic functions of the sliding sunroof

- ① The term "sliding sunroof" refers to the panorama roof with power tilt/sliding panel.

Rain-closing feature when driving

Vehicles with a panorama roof with power tilt/sliding panel: If it starts to rain, the raised sliding sunroof will automatically be lowered while the vehicle is in motion.

Automatic lowering function

Vehicles with a panorama roof with power tilt/sliding panel: If the sliding sunroof is raised at the rear, it will automatically be lowered slightly at higher speeds. At low speeds, it will be raised again automatically.

⚠ WARNING Risk of becoming trapped by automatic lowering of the sliding sunroof

At higher speeds, the raised sliding sunroof will automatically be lowered slightly at the rear.

- ▶ Make sure that nobody reaches into the sliding sunroof's range of movement while the vehicle is in motion.
- ▶ If somebody becomes trapped, briefly push the sliding sunroof button forwards or backwards.

Rectifying problems with the sliding sunroof

⚠ WARNING Risk of becoming trapped or fatal injuries when the sliding sunroof is closed again

If you close the sliding sunroof again immediately after it has been blocked or reset, the sliding sunroof will close with increased or maximum force.

There is a risk of becoming trapped or even of fatal injuries!

- ▶ Make sure that no parts of the body are in the closing area.
- ▶ If someone is trapped, release the control panel immediately.

or

- ▶ Touch the control panel during automatic closing.
The closing process will be stopped.

The sliding sunroof cannot be closed and you cannot see the cause.

- ① The term "sliding sunroof" refers to the panorama roof with power tilt/sliding panel.

If the sliding sunroof is obstructed during closing and reopens again slightly:

- ▶ Immediately after automatic reversing, swipe forwards across the control panel (→ page 96) and hold until the sliding sunroof is closed.
The sliding sunroof will be closed with increased force.

If the sliding sunroof is obstructed again and opens again slightly:

- ▶ Repeat the previous step.
The sliding sunroof will be closed again with increased force.

The sliding sunroof or the front roller sunblind is not operating smoothly.

- ▶ Reset the sliding sunroof and the roller sunblind.

Resetting the sliding sunroof and the roller sunblind

- ▶ Repeatedly swipe forwards across the control panel (→ page 96) and hold until the sliding sunroof is completely closed.
- ▶ Press and hold the control panel for another second.
- ▶ Press and hold the control panel until the front roller sunblind is completely closed.
- ▶ Press and hold the control panel for another second.
- ▶ Use automatic operation to fully open and then close the sliding sunroof.

The rear roller sunblind is not operating smoothly.

- ▶ Reset the rear roller sunblind.

Resetting the rear roller sunblind

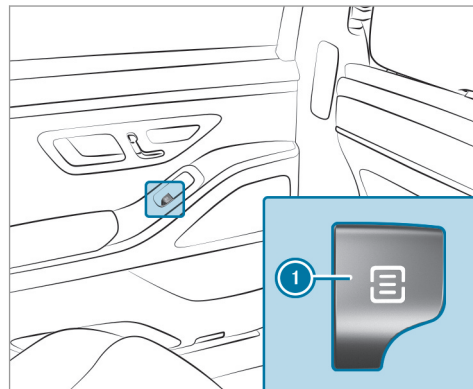

- ▶ Pull and hold button ① repeatedly until the rear roller sunblind is fully closed.
- ▶ Pull button ① for another second.

- ▶ Use automatic operation to fully open and then close the rear roller sunblind.

Roller sun blinds

Extending or retracting the roller sunblinds on the rear side windows

The roller sunblinds for the rear side windows can be operated with the buttons for the side windows.

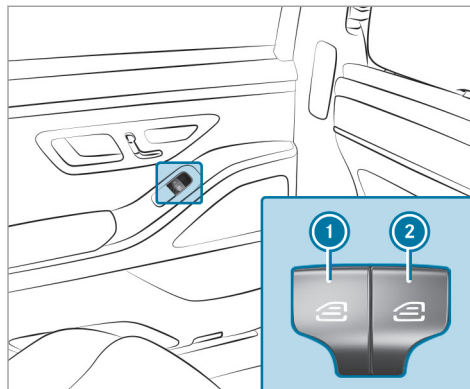

- ① Rear left side window/roller sunblind
- ② Rear right side window/roller sunblind

- ▶ **To close fully:** pull the corresponding button when the side window is closed or is in the process of closing.
- ▶ **To open fully:** press the corresponding button.

Extending or retracting the rear window roller sunblind

⚠ WARNING Risk of becoming trapped when extending or retracting the roller sunblind

Body parts may become trapped in the roller sunblind's range of movement.

- ▶ Ensure there are no body parts in the range of movement.
- ▶ If someone becomes trapped, briefly press the button again. The opening or closing process will briefly be stopped. The roller sunblind will then return to its starting position.

Extending or retracting from the driver's seat

! NOTE Damage caused by objects

Objects can cause the roller sunblind to malfunction.

- ▶ Do not store objects on the rear shelf.

102 Opening and closing

- ▶ Ensure that the roller sunblind can move freely.

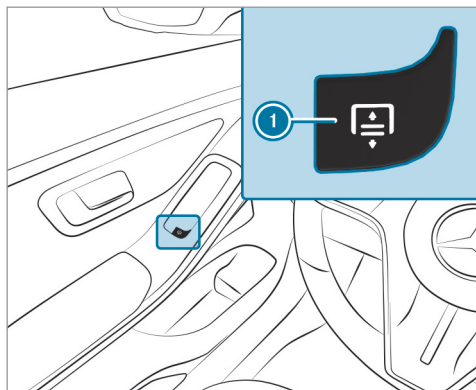

- ▶ Press button ①.
- ① Depending on the model, button ① is located on the door control panel on the driver's side.

Extending or retracting from the rear passenger compartment

! NOTE Damage caused by objects

Objects can cause the roller sunblind to malfunction.

- ▶ Do not store objects on the rear shelf.
- ▶ Ensure that the roller sunblind can move freely.

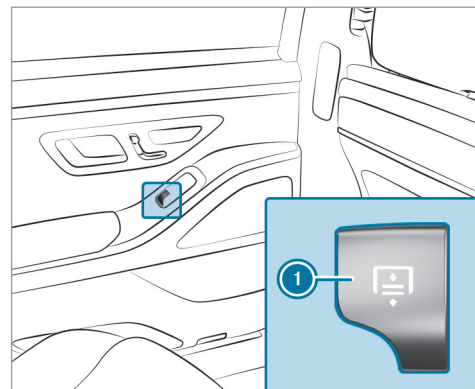

- ▶ **To extend:** pull switch ①.
- ▶ **To retract:** press switch ①.

When the child safety lock for the rear side windows is activated, switch ① cannot be operated.

Anti-theft protection

Function of the immobilizer

The immobilizer prevents your vehicle from being started without the correct SmartKey.

The immobilizer is automatically activated when the ignition is switched off and deactivated when the ignition is switched on.

When leaving the vehicle, always take the SmartKey with you and lock the vehicle. Anyone can start the engine if a valid SmartKey has been left inside the vehicle.

- ❗ In the event the engine cannot be started (yet the vehicle's battery is charged), the system is not operational. Contact an authorized Mercedes-Benz Center or call 1-800-FOR-MERCEdes (in the USA) or 1-800-387-0100 (in Canada).

ATA (anti-theft alarm system)

Function of the ATA system

If the ATA system is armed, a visual and audible alarm is triggered in the following situations:

- When a door is opened
- When the trunk lid is opened
- When the hood is opened
- When the interior motion sensor is triggered (→ page 104)
- When the tow-away alarm is triggered (→ page 104)

The ATA system is armed automatically after approximately ten seconds in the following situations:

- After locking the vehicle with the SmartKey
- After locking the vehicle using KEYLESS-GO

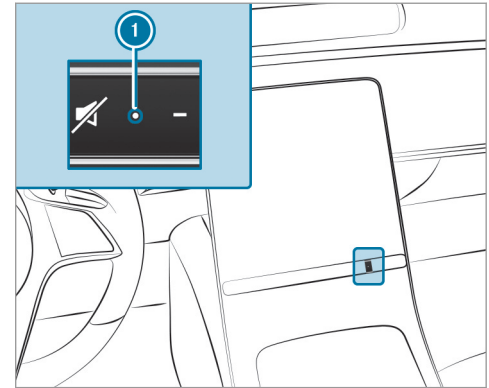

Indicator lamp ❶ flashes when the ATA system is armed.

The ATA system is deactivated automatically in the following situations:

- After unlocking the vehicle with the SmartKey
- After unlocking the vehicle using KEYLESS-GO

104 Opening and closing

- After pressing the start/stop button with the SmartKey in the marked space (→ page 190)
- ① When the Mercedes-Benz emergency call system is active and the alarm stays on for more than 30 seconds, a message is automatically sent to the Customer Assistance Center (→ page 327).
- ① In the case of severe battery discharging, the anti-theft alarm system is automatically deactivated to facilitate the next engine start.

Deactivating the ATA

▶ Press the ,  or  button on the SmartKey.

or

▶ Press the start/stop button with the SmartKey in the marked space (→ page 190)

Deactivating the alarm using KEYLESS-GO

▶ With the SmartKey outside the vehicle, touch the inner surface of the door handle.

Function of the tow-away alarm

① This function may not be available in all countries.

An audible and visual alarm is triggered if an alteration to your vehicle's angle of inclination is detected while the tow-away alarm is armed.



The tow-away alarm is automatically armed after approximately 60 seconds:

- After locking the vehicle with the SmartKey
- After locking the vehicle using KEYLESS-GO

The tow-away alarm is only armed when the following components are closed:

- Doors
- Trunk lid

The tow-away alarm is automatically deactivated:

- After pressing the  or  button on the SmartKey
- After pressing the start/stop button with the SmartKey in the marked space (→ page 190)

- After unlocking the vehicle using KEYLESS-GO
- When using HANDS-FREE ACCESS

Information on collision detection on a parked vehicle (→ page 216).

Arming/disarming the tow-away alarm

Multimedia system:

  ▶ Settings ▶ Vehicle

▶ Opening/closing ▶ Vehicle Protection

▶ Arm or disarm **Tow-away Protection**.

The tow-away alarm is armed again in the following cases:

- The vehicle is unlocked again.
- A door is opened.
- The vehicle is locked again.

Function of the interior motion sensor

① This function may not be available in all countries.

When the interior motion sensor is activated, a visual and audible alarm is triggered if movement is detected in the vehicle interior.



The interior motion sensor is activated automatically after approximately ten seconds:

- After locking the vehicle with the SmartKey
- After locking the vehicle using KEYLESS-GO

The interior motion sensor is only activated when the following components are closed:

- Doors
- Trunk lid

The interior motion sensor is automatically deactivated:

- After pressing the  or  button on the SmartKey
- After pressing the start/stop button with the SmartKey in the marked space (→ page 190)
- After unlocking the vehicle using KEYLESS-GO
- When using HANDS-FREE ACCESS

The following situations can lead to a false alarm:

- When there are moving objects such as mascots in the vehicle interior
- When a side window is open
- When a panoramic sliding sunroof is open

Activating/deactivating the interior motion sensor

Multimedia system:

- ↳  » Settings » Vehicle
- » Opening/closing » Vehicle Protection
- ▶ Activate or deactivate Interior Motion Sensor.

The Interior motion sensor is activated again in the following cases:

- The vehicle is unlocked again.
- A door is opened.
- The vehicle is locked again.

Notes on the correct driver's seat position

⚠ WARNING Risk of accident due to adjusting the vehicle settings while the vehicle is in motion

You could lose control of the vehicle in the following situations in particular:

- If you adjust the driver's seat, the head restraint, the steering wheel or the mirror while the vehicle is in motion
 - If you fasten your seat belt while the vehicle is in motion
- ▶ Before starting the engine: In particular, adjust the driver's seat, head restraint, steering wheel and mirror, and fasten your seat belt.



Ensure the following when adjusting steering wheel ①, seat belt ② and driver's seat ③:

- You are sitting as far away from the driver's airbag as possible, taking the following points into consideration:
- You are sitting in an upright position
- Your thighs are slightly supported by the seat cushion
- Your legs are not fully extended and you can depress the pedals properly
- The back of your head is supported at eye level by the center of the head restraint

- You can hold the steering wheel with your arms slightly bent
- You can move your legs freely
- You can see all the displays on the instrument cluster clearly
- You have a good overview of the traffic conditions
- Your seat belt sits snugly against your body and passes across the center of your shoulder and across your hips in the pelvic area

Seats

Adjusting the front seat electrically

⚠ WARNING Risk of becoming trapped if the seats are adjusted by children

Children could become trapped if they adjust the seats, particularly when unattended.

- ▶ When leaving the vehicle, always take the SmartKey with you and lock the vehicle.

- ▶ Never leave children unattended in the vehicle.

You can adjust the seats when the ignition is switched off.

⚠ WARNING Risk of becoming trapped when adjusting the seat

When you adjust a seat, you or other vehicle occupants could become trapped, e.g. on the seat guide rail.

- ▶ When adjusting a seat, make sure that no one has any part of their body within the sweep of the seat.

Observe the safety notes on "Airbags" and "Children in the vehicle".

⚠ WARNING Risk of accident due to adjusting the vehicle settings while the vehicle is in motion

You could lose control of the vehicle in the following situations in particular:

- If you adjust the driver's seat, the head restraint, the steering wheel or the mirror while the vehicle is in motion
 - If you fasten your seat belt while the vehicle is in motion
- ▶ Before starting the engine: In particular, adjust the driver's seat, head restraint, steering wheel and mirror, and fasten your seat belt.

⚠ WARNING Risk of becoming trapped if the seat height is adjusted carelessly

If you adjust the seat height carelessly, you or other vehicle occupants could be trapped and thereby injured.

Children in particular could accidentally press the electrical seat adjustment buttons and become trapped.

- ▶ While moving the seats, make sure that hands or other body parts do not get under the lever assembly of the seat adjustment system.

⚠ WARNING Risk of injury due to incorrectly adjusted head restraints

If head restraints have not been adjusted correctly, there is an increased risk of injury in the head and neck area, e.g. in the event of an accident or sudden braking.

- ▶ Before driving off, make sure for every vehicle occupant that the center of the head restraint supports the back of the head at about eye level.

Adjust the head restraint fore-and-aft position so that it is as close as possible to the back of your head.

⚠ WARNING Risk of injury or death due to an incorrect seat position

The seat belt does not offer the intended level of protection if you have not moved the seat backrest to an almost vertical position. In particular, you could slip beneath the seat-belt and become injured.

- ▶ Adjust the seat properly before beginning your journey.
- ▶ Always ensure that the seat backrest is in an almost vertical position and that the shoulder belt is routed across the center of your shoulder.

⚠ WARNING Risk of injury due to excessive strain on the grab handle

If you apply your full body weight to the grab handle or pull it abruptly, the grab handle may be damaged or become loose from its anchorage.

- ▶ Use the grab handles only to stabilize the seating position or to assist in getting in and out of the seat.

⚠ WARNING Risk of injury or death due to objects under the co-driver seat

Objects trapped under the co-driver seat can interfere with the function of the automatic co-driver airbag shutoff or damage the system.

- ▶ Do not store any objects under the co-driver seat.
- ▶ When the co-driver seat is occupied, make sure that no objects are trapped under the co-driver seat.

! NOTE Damage to the seats when moving the seats back

The seats may be damaged by objects when moving the seats back.

- ▶ When moving the seats back, make sure that there are no objects in the footwell, under or behind the seats.

The switches for adjusting the seats do not move. You will therefore receive no direct feedback on the switch while pressing the switch. Feedback is provided only by the movement of the seat.

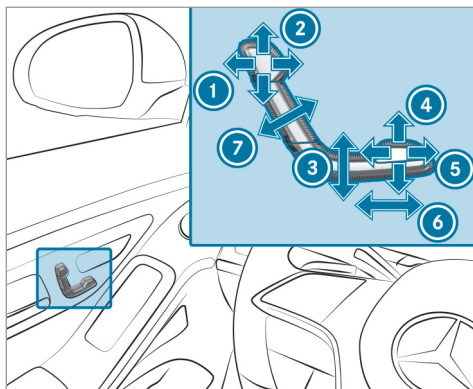

- ① Head restraint fore-and-aft position (vehicles with an EASY ADJUST luxury head restraint)
- ② Head restraint height
- ③ Seat height
- ④ Seat cushion inclination
- ⑤ Seat cushion length
- ⑥ Seat fore-and-aft position
- ⑦ Seat backrest inclination

▶ Save the settings with the memory function (→ page 130).

- ① The head restraint height will be adjusted automatically when you adjust the seat height or the seat fore-and-aft position.
- ① **Vehicles with EASY ADJUST luxury head restraints:** The fore-and-aft position of the head restraint will be adjusted automatically when you adjust the backrest angle.

Adjusting the front passenger seat electrically from the driver's seat

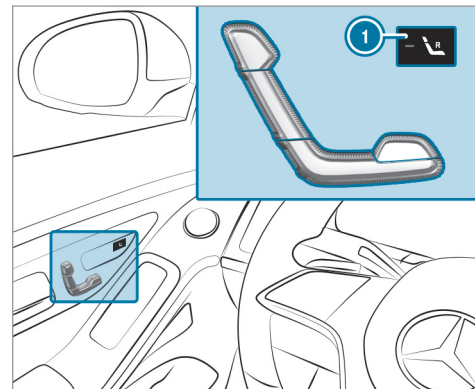

You can call up the following functions for the front passenger seat:

- Seat adjustment
- Seat heating
- Seat ventilation
- Memory function

- ▶ **To select the front passenger seat:** press button ①.
When the indicator lamp lights up, the front passenger seat is selected.
- ▶ Adjust the front passenger seat using the buttons on the driver's side door control panel.

Adjusting the front passenger seat electrically from the rear passenger compartment

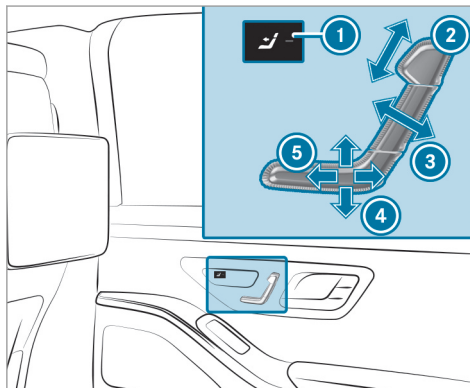

Vehicles with electrically adjustable outer seats

- ① Selects the front passenger seat
- ② Head restraint height
- ③ Seat backrest inclination
- ④ Seat height
- ⑤ Seat fore-and-aft position

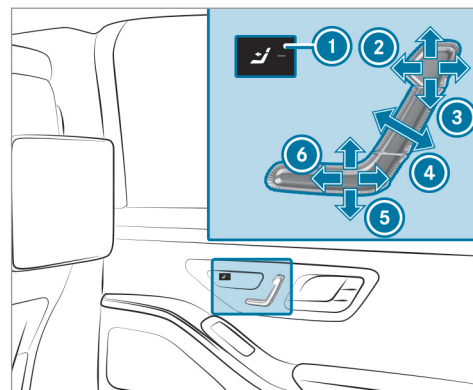

Vehicles with an EASY ADJUST luxury head restraint

- ① Selects the front passenger seat
- ② Head restraint fore-and-aft position
- ③ Head restraint height
- ④ Seat backrest inclination
- ⑤ Seat height
- ⑥ Seat fore-and-aft position

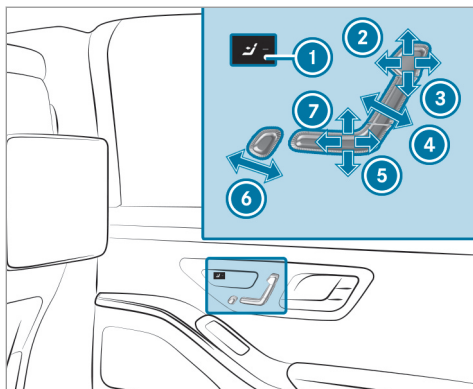

Vehicles with seat for chauffeur mode and long wheelbase

- ① Selects the front passenger seat
- ② Head restraint fore-and-aft position
- ③ Head restraint height
- ④ Seat backrest inclination
- ⑤ Seat height
- ⑥ Front passenger seat footrest
- ⑦ Seat fore-and-aft position

The footrest can be adjusted only when one of the following conditions has been fulfilled:

- Depending on the equipment, the front passenger seat is in one of the following positions:
 - Vehicles without leg rest: the front passenger seat has moved into a random position.
 - Vehicles with leg rest: the front passenger seat has been moved fully forward.
- The front passenger seat is in the position for chauffeur mode.

- ▶ Adjust the rear seat (→ page 111).
- ▶ Adjust the reclining rear seat (→ page 112).
- ▶ **To select the front passenger seat:** press button ①. When the indicator lamp lights up, the front passenger seat is selected.
- ▶ Adjust the front passenger seat using the buttons on the door operating unit in the rear passenger compartment.

- ① You can use the rear-compartment child safety lock to disable this function (→ page 75).

Adjusting the rear seats electrically

⚠ WARNING Risk of injury or death due to an incorrect seat position

The seat belt does not offer the intended level of protection if you have not moved the seat backrest to an almost vertical position.

In particular, you could slip beneath the seat-belt and become injured.

- ▶ Adjust the seat properly before beginning your journey.
- ▶ Always ensure that the seat backrest is in an almost vertical position and that the shoulder belt is routed across the center of your shoulder.

The switches for adjusting the seats do not move. You will therefore receive no direct feedback on the switch while pressing the switch.

Feedback is provided only by the movement of the seat.

You can electrically adjust only the outer seats in the rear passenger compartment.

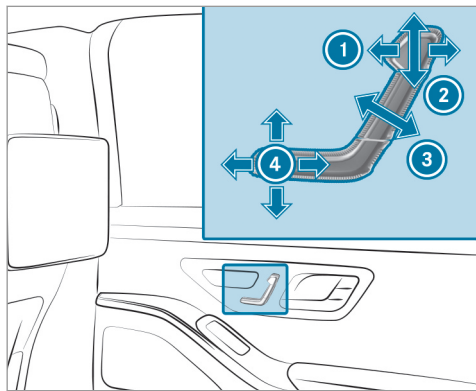

- ① Fore-and-aft position of the head restraint (vehicles with active multicontour seat)
- ② Head restraint height

- ③ Seat backrest inclination
- ④ Combined seat cushion inclination and length

▶ Save the settings with the memory function (→ page 132).

Adjusting the reclining rear seats electrically

The reclining rear seat is available in long-wheel-base vehicles equipped with "Executive seats". In vehicles without a reclining rear seat, the button for setting the angle and fore-and-aft position of the leg rest has no function.

The reclining rear seat is on the front passenger side.

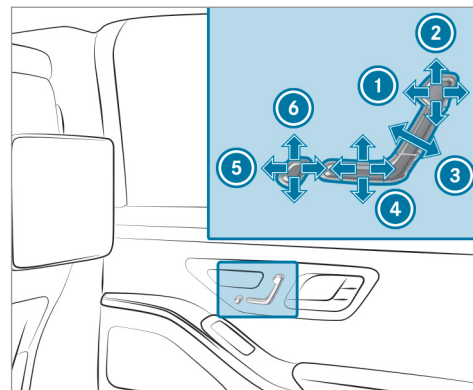

- ① Fore-and-aft position of the head restraint (vehicles with active multicontour seat)
- ② Head restraint height
- ③ Seat backrest inclination
- ④ Combined seat cushion inclination and length
- ⑤ Fore-and-aft position of the leg rest
- ⑥ Angle of the leg rest

- ▶ Save the settings with the memory function (→ page 132).
- ⓘ The leg rest will fold down if overloaded. If this is the case, fold up the leg rest and engage it.
- ⓘ Vehicles with a long wheelbase and the Chauffeur/Rear Seat Memory Package also have a footrest. This is located on the lower part of the front passenger seat backrest (→ page 116).

Setting the fully reclined position

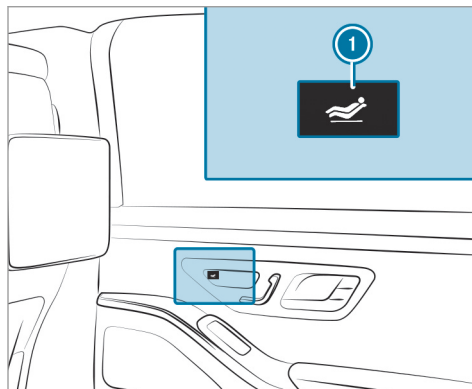

- ▶ **To set the fully reclined position:** press button ①.
 - The rear seat will move into the fully reclined position.
 - The front passenger seat will move into the position for chauffeur mode.

- The footrest will move out from under the front passenger seat.
- If available, the leg rest will rise.

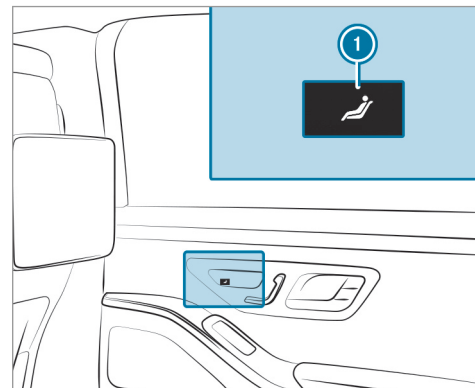

- ▶ **To restore the standard seat settings:** press button ①.
 - ⓘ You can use the rear-compartment child safety lock to disable this function (→ page 75).

- ① The leg rest will fold down if overloaded. If this is the case, fold up the leg rest and engage it.

Chauffeur mode

Information on chauffeur mode

⚠ WARNING Risk of injury due to incorrectly adjusted head restraints

If head restraints have not been adjusted correctly, there is an increased risk of injury in the head and neck area, e.g. in the event of an accident or sudden braking.

- ▶ Before driving off, make sure for every vehicle occupant that the center of the head restraint supports the back of the head at about eye level.

Adjust the head restraint fore-and-aft position so that it is as close as possible to the back of your head.

⚠ WARNING Risk of injury or death due to objects under the co-driver seat

Objects trapped under the co-driver seat can interfere with the function of the automatic co-driver airbag shutoff or damage the system.

- ▶ Do not store any objects under the co-driver seat.
- ▶ When the co-driver seat is occupied, make sure that no objects are trapped under the co-driver seat.

! NOTE Damage to objects in the luggage net of the front passenger footwell when adjusting the front passenger seat to the chauffeur position

Objects in the luggage net in the front passenger footwell can become damaged when the front passenger seat is adjusted to the chauffeur position.

- ▶ Remove the objects from the luggage net.

! NOTE Damage to the seats when moving the seats back

The seats may be damaged by objects when moving the seats back.

- ▶ When moving the seats back, make sure that there are no objects in the footwell, under or behind the seats.

The switches for adjusting the seats do not move. You will therefore receive no direct feedback on the switch while pressing the switch. Feedback is provided only by the movement of the seat.

Observe the following:

- Adjust the front passenger seat for chauffeur mode before the journey

For chauffeur mode, the following settings are made for the front passenger seat:

- The seat is moved forwards
- The backrest is tilted forwards
- The head restraint is folded forwards

The front passenger seat will automatically move from the chauffeur position back into the normal position in the following situations:

- The front passenger seat is adjusted using the buttons in the door operating unit on the front passenger side
- The front passenger seat belt is fastened
- An occupant is detected on the front passenger seat
- The front passenger seat backrest is adjusted rearwards.
- The front passenger seat is moved in the fore-and-aft direction out of the chauffeur area

Positioning the front passenger seat for chauffeur mode

Requirements:

- The front passenger seat is not occupied.
- The front passenger seat belt is not inserted in the buckle.

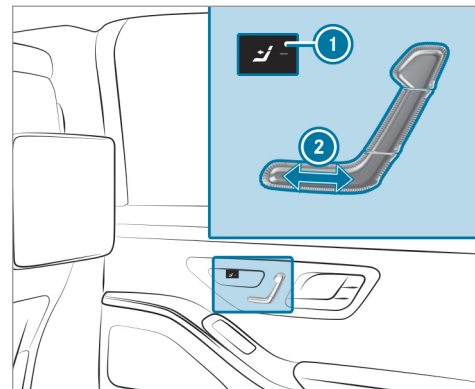
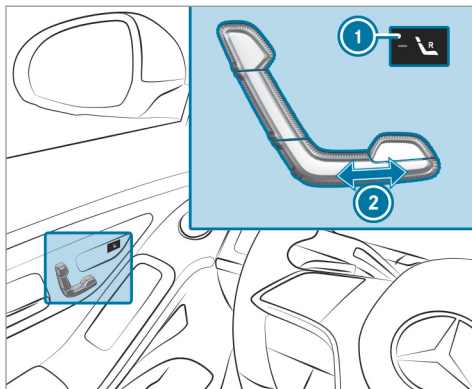

- ① Selects the front passenger seat
- ② Adjusts the seat fore-and-aft position

▶ **To select the front passenger seat:** press button ①. When the indicator lamp lights up, the front passenger seat is selected.

Setting the chauffeur position

- ▶ Push button ② forwards and hold it in this position.
The front passenger seat will move forward and stop at the threshold of the area for chauffeur mode.
 - ▶ Release button ②.
 - ▶ Push button ② forward and hold it again until the front passenger seat is in the position for chauffeur mode.
The front passenger seat head restraint will fold forwards. The front passenger seat will move forward.
- ① If the front passenger seat is already at the threshold to the area for chauffeur mode, the position for chauffeur mode will be set immediately.
- ▶ Save the settings with the memory function (→ page 132).
 - ① You can use the rear-compartment child safety lock to disable this function (→ page 75).

Using the footrest on the front passenger seat

Requirements:

- Depending on the equipment, the front passenger seat is in one of the following positions:
 - Vehicles without leg rest: the front passenger seat has moved into a random position.
 - Vehicles with leg rest: the front passenger seat has been moved fully forward.
- The front passenger seat is in the position for chauffeur mode.

Using the footrest

The footrest is located on the lower part of the front passenger seat backrest.

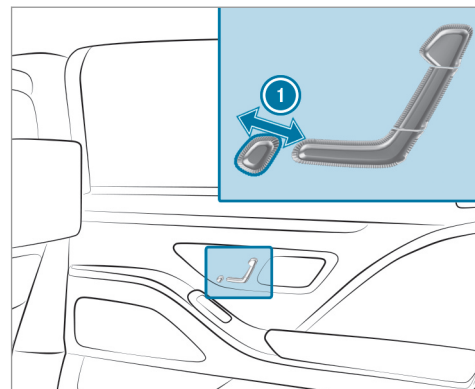

- ▶ Push button ① towards the rear.
The footrest will move out from under the front passenger seat.
- ▶ Push the extended footrest upwards with your foot until it releases.
- ▶ Allow the footrest to lower.
The footrest will position itself on the floor.

Storing the footrest

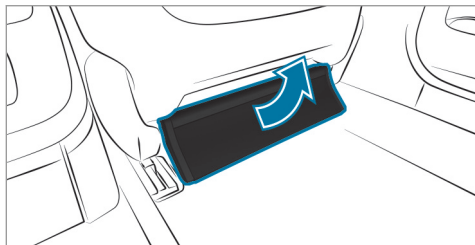

- ▶ Push the footrest upwards with your foot until it engages.
- ▶ Push button ❶ forwards. The footrest will retract underneath the front passenger seat.

Moving the front passenger seat into the normal position (chauffeur mode)

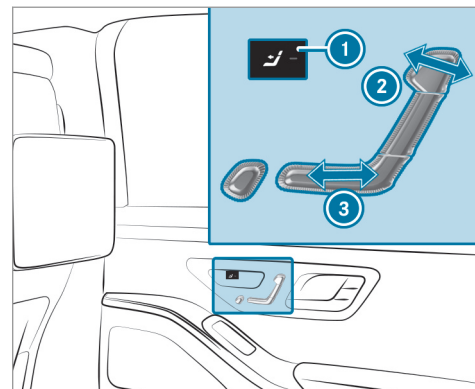
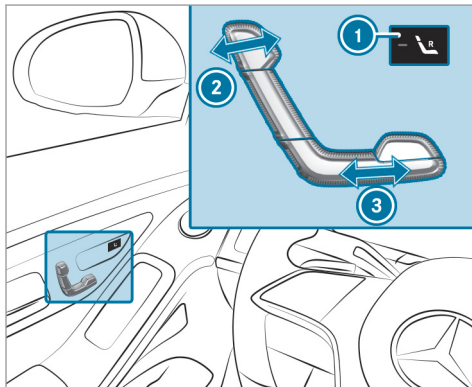

- ▶ **To select the front passenger seat:** press button ❶. When the indicator lamp lights up, the front passenger seat is selected.

Setting the normal position

- ▶ Push button ❸ towards the rear and hold it in this position. The front passenger seat will move to the threshold of the area for chauffeur mode.

The head restraint on the front passenger side will be moved into the upright position.

The front passenger seat will then move further towards the rear.

or

▶ Briefly push button ② towards the rear. The front passenger seat will move automatically to the threshold of the area for chauffeur mode. The head restraint on the front passenger side will be moved into the upright position.

① You can also set the normal position from the front passenger seat. To do so, press any button on the door operating unit on the front passenger side.

▶ Call up the settings with the memory function (→ page 132).

① You can use the rear-compartment child safety lock to disable this function (→ page 75).

Head restraints

Adjusting the front seat luxury head restraints mechanically

⚠ WARNING Risk of accident due to adjusting the vehicle settings while the vehicle is in motion

You could lose control of the vehicle in the following situations in particular:

- If you adjust the driver's seat, the head restraint, the steering wheel or the mirror while the vehicle is in motion
- If you fasten your seat belt while the vehicle is in motion

▶ Before starting the engine: In particular, adjust the driver's seat, head restraint, steering wheel and mirror, and fasten your seat belt.

⚠ WARNING Risk of injury due to incorrectly adjusted head restraints

If head restraints have not been adjusted correctly, there is an increased risk of injury in the head and neck area, e.g. in the event of an accident or sudden braking.

▶ Before driving off, make sure for every vehicle occupant that the center of the head restraint supports the back of the head at about eye level.

Adjust the head restraint fore-and-aft position so that it is as close as possible to the back of your head.

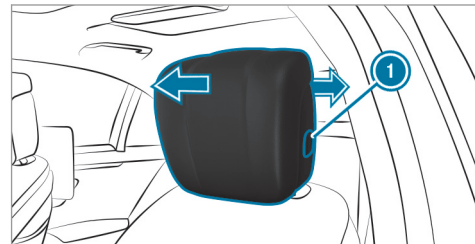

- ▶ **To move forwards:** pull the head restraint forwards.
- ▶ **To move backwards:** press release knob ① and push the head restraint backwards.

Attaching and removing the additional cushion of the front-seat luxury head restraint

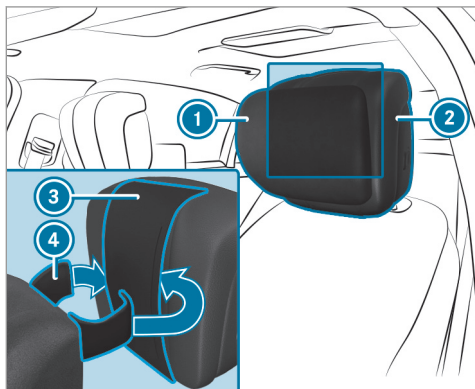

- ▶ Position head restraint ② as far forwards as possible.

- ▶ **To attach the additional cushion:** open Velcro strip ④ on the back of additional cushion ①.
- ▶ Guide Velcro strip ④ between head restraint ② and strip ③.
- ▶ Close Velcro strip ④.
- ▶ **Change the position of the additional cushion:** move additional cushion ① up or down.
- ▶ **To remove additional cushion:** open Velcro strip ④ of additional cushion ①.
- ▶ Remove additional cushion ①.

Lowering and positioning the rear seat head restraints electrically from the front compartment

Multimedia system:



- ▶ Tap on . The outer head restraints will lower.
- ▶ Tap on again. The outer head restraints will move into the last stored position.

Adjusting the outer rear seat head restraints manually

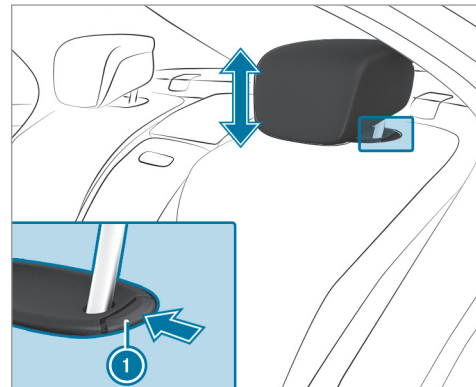

- ▶ **To raise:** pull the head restraint upwards and let it engage.

Height adjustment

- ▶ Push release button ① in the direction of the arrow.

- ▶ Push the head restraint down and let it engage.

Adjusting the outer luxury head restraints of the rear seats manually

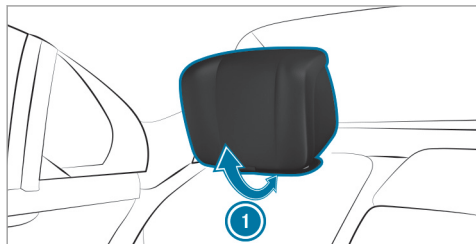

- ▶ **To adjust the head restraint angle:** pull or push the head restraint in the direction of arrow 1.

Attaching and removing the additional cushion of the head restraint in the rear passenger compartment (individual seats)

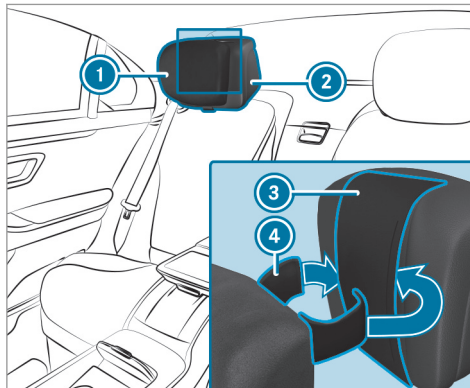

- ▶ Position head restraint 2 as far forwards as possible.
- ▶ **To attach the additional cushion:** open Velcro strip 4 on the back of additional cushion 1.

- ▶ Guide Velcro strip 4 between head restraint 2 and strip 3.
- ▶ Close Velcro strip 4.
- ▶ **To change the position of the additional cushion:** move additional cushion 1 up or down.
- ▶ **To remove additional cushion:** open Velcro strip 4 of additional cushion 1.
- ▶ Remove additional cushion 1.

Attaching heated additional cushion

In vehicles with electrically adjustable head restraints, you can heat the additional cushion.

- ▶ Attach the additional cushion to the head restraint as described.
- ▶ Move the head restraint to the very top.

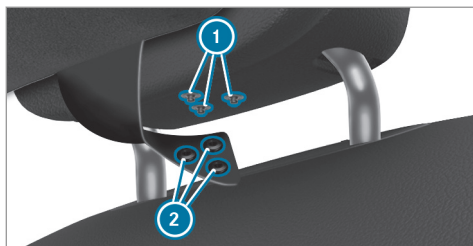

- ▶ Push press-studs ② on the additional strip into counterparts ① on the head restraint.
- ▶ Move the head restraint to the desired height.
- ▶ **To switch neck heating from the additional cushion on/off:** make sure that press-studs ② on the additional strip are correctly pushed into counterparts ① on the head restraint.
- ▶ Ensure that the "Couple neck heat to seat heating" function is active (→ page 122).
- ▶ Activate or deactivate the seat heating (→ page 124).

Folding the center head restraint into position and folding it back manually

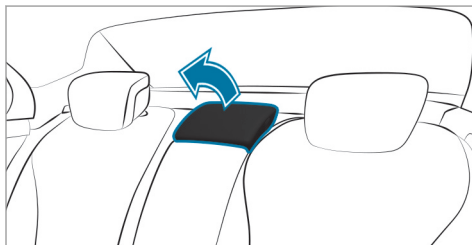

- ▶ **To fold into position:** pull the head restraint upwards until it engages.

Folding down

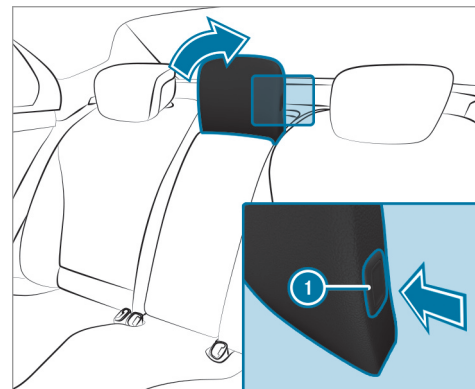

- ▶ Press button ①.
- ▶ Fold down the head restraint completely.

The center head restraint has a usage position and a non-usage position. The usage position is the upright position in which the head restraint is locked; the non-usage position is the position in which the head restraint is folded downwards.

When the center seat is used, the head restraint must be in the upright, locked usage position.

Configuring the seat settings

Multimedia system:

→  ▶▶ Comfort ▶▶ Seat

Adjusting the air cushions.

- ▶ On the corresponding menu, adjust the air cushions for [Lumbar](#), [Shoulders](#) or [Side Bolsters](#).

Setting the seat heating balance

- ▶ Select [Heating Settings](#).
 - ▶ Select [Seat Heating Balance](#).
 - ▶ Adjust the heat distribution for the desired seat.
-  The seat heating balance can be set in the [Seat Climate Control](#) menu in the rear passenger compartment.

Coupling neck heat to seat heating

- ▶ Select [Additional Neck Warmer](#).

- ▶ Switch the function for the desired seat on or off.
If the function is active, the neck heat of the additional cushion has been coupled to the seat heating.

Setting automatic seat adjustment

 **WARNING** Risk of becoming trapped during adjustment of the driver's seat after calling up a driver profile

Selecting a user profile may trigger an adjustment of the driver's seat to the position saved under the user profile. You or other vehicle occupants could be injured in the process.

- ▶ Make sure that when the position of driver's seat is being adjusted using the multimedia system, no people or body parts are in the seat's range of movement.

If there is a risk of someone becoming trapped, stop the adjustment process immediately:

- ▶ a) Tap the warning message on the central display.
- or
- ▶ b) Press a memory position button or a seat adjustment switch on the driver's door.
The adjustment process will be stopped.

Multimedia system:

→  ▶▶ Comfort ▶▶ Seat
▶▶ [Automatic Seat Positioning](#)

Adjusting driver's seat and steering wheel position to body size

The vehicle calculates a suitable driver's seat and steering wheel position on the basis of the driver's body size and sets this directly.

- ▶ **To set the unit of measurement:** select [cm](#) or [ft/in](#).

- ▶ Set the size using the scale.
- ▶ Select **Start Positioning**.
The driver's seat and steering wheel position is adjusted to the body size that has been set.

- ① If the driver's seat and steering wheel position calculated by the vehicle is not practical or comfortable, it can be manually adapted at any time via the control buttons. The outside mirrors are not set via this function. Instead, they have to be set manually via the operating switches.
- ① You can also configure these settings via the Mercedes me user account for your user profile. By synchronizing the profiles in the vehicle and the Mercedes me connect profiles, you can carry over these settings for your vehicle. Further information about synchronizing user profiles .

Setting automatic adjustment of the lateral support (active multicontour seat)

Multimedia system:

→  ▶▶ Comfort ▶▶ Seat

- ▶ Select **Dynamic Multicontour Seat**.

With this function, the lateral support of the active multicontour seat is automatically adjusted to the driving and cornering dynamics of the vehicle.

- ▶ Select the desired setting.

Overview of massage programs



- **Hot Relaxing Back:** Based on hot stone massage, the program combines heat and massage. It starts by massaging the back. In addition, warm pressure points become noticeable, starting in the pelvic area.
- **Hot Relaxing Shoulders** Combination of heat and massage. It starts by massaging the shoulders. In addition, warm pressure points become noticeable, starting in the pelvic area.
- **Activating Massage** Activating massage program with upward-moving massage waves.
- **Classic Massage** Calming back massage program.
- **Wave Massage** Regenerating massage program via massage waves across the back and in the seat cushion.
- **Mobilizing Massage** Mobilizing massage program with upward-moving massage waves. Can promote slower, deeper respiration. This can improve the supply of oxygen to cells and the brain.
- **Workout, Backrest** and **Workout, Cushion** These programs require your cooperation. Alternating between tensing and releasing helps to improve blood flow to your muscles. Press against a pressure point as soon as you feel it to activate back, abdominal and leg muscles.
- **Deep Waves:** Wave-like movements in the cushion can promote blood flow and metabolic processes in the lower back and legs.
- **Deep Workout:** Connect the **Workout, Backrest** to the **Workout, Cushion**. The vibrating

massage in the cushion intensifies the effectiveness of tensing and releasing muscles when you tense against the pressure point. This supports metabolic processes and blood flow in the seat area and legs.

Selecting the massage program for the front seats

Multimedia system:

→  » Comfort » Massage

- ▶ Select a massage program (→ page 123).
 - ▶ Start the program for the desired seat .
 - ▶ **To set the massage intensity:** switch **Intensive** on or off.
-  For the rear seats, the massage programs can be selected on the following devices (if available):
- On the rear displays
 - On the MBUX rear tablet

Resetting seat settings

Multimedia system:

→  » Comfort » Seat

- ▶ Select **Reset**.
- ▶ Select  for the desired seat.

Switching the seat heating on/off

 **WARNING** Risk of burns due to repeatedly switching on the seat heating

Repeatedly switching on the seat heating can cause the seat cushion and seat backrest padding to become very hot.

In particular, the health of persons with limited temperature sensitivity or a limited ability to react to high temperatures may be affected or they may even suffer burn-like injuries.

- ▶ Do not repeatedly switch on the seat heating.

To protect against overheating, the seat heating may be temporarily deactivated after it is switched on repeatedly.

 **NOTE** Damage to the seats caused by objects or documents when the seat heating is switched on

When the seat heating is switched on, overheating may occur due to objects or documents placed on the seats, e.g. seat cushions or child seats. This could cause damage to the seat surface.

- ▶ Make sure that no objects or documents are on the seats when the seat heating is switched on.

Requirements:

- The power supply is switched on.

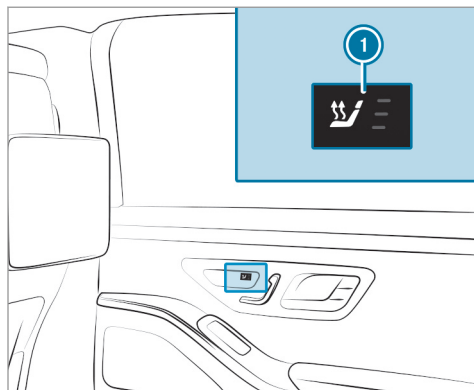
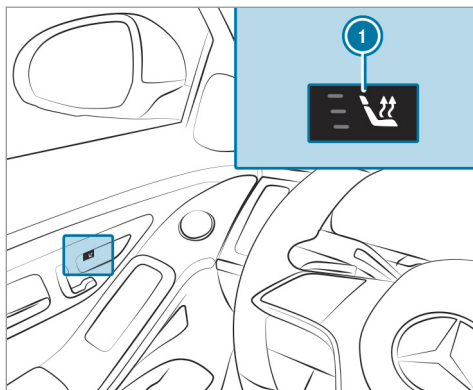

▶ Press button ① repeatedly until the desired heating level is set.

Depending on the heating level, up to three indicator lamps will light up. If all indicator lamps are off, the seat heating is switched off.

- ① The seat heating will automatically switch down from the three heating levels after 8,

10 and 20 minutes until the seat heating switches off.

- ① If you switch the power supply off and on again within 20 minutes, the previous setting of the seat heating for the driver's seat will remain active.
- ① You can set the heat distribution of the heated sections among the seat cushions and seat backrests on the front and rear seats using the multimedia system (→ page 122).
- ① Vehicles with the Warmth Comfort Package: you can adjust the heating of the center console and door armrests using the multimedia system (→ page 125).

Setting the panel heating

Multimedia system:

→ ▶ [Comfort](#) ▶ [Seat](#)
▶ [Heating Settings](#) ▶ [Panel Heating](#)

When the seat heating is switched on, the armrests, the center panels of the doors and the center console can be heated.

- ▶ Switch the function for the desired seats on or off.

Switching the seat ventilation on/off

Requirements:

- The power supply is switched on.

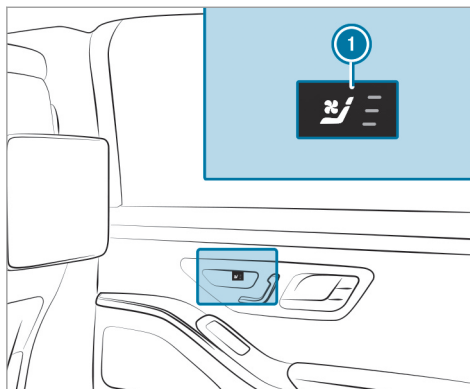
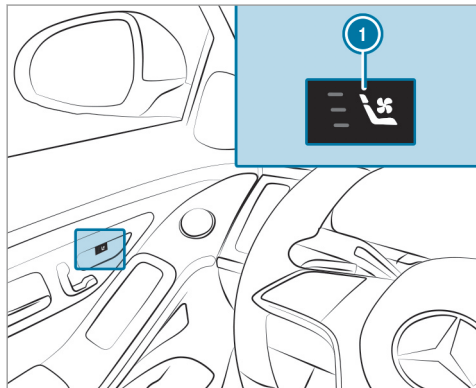

- ▶ Press button ① repeatedly until the desired blower setting has been reached. Depending on the blower setting, up to three indicator lamps will light up. If all indicator lamps are off, the seat ventilation is switched off.

① If you switch the power supply off and on again within 20 minutes, the previous seat

ventilation setting for the driver's seat will remain active.

Steering wheel

Adjusting the steering wheel electrically

⚠ WARNING Risk of accident due to adjusting the vehicle settings while the vehicle is in motion

You could lose control of the vehicle in the following situations in particular:

- If you adjust the driver's seat, the head restraint, the steering wheel or the mirror while the vehicle is in motion
 - If you fasten your seat belt while the vehicle is in motion
- ▶ Before starting the engine: In particular, adjust the driver's seat, head restraint, steering wheel and mirror, and fasten your seat belt.

⚠ WARNING Risk of entrapment for children when adjusting the steering wheel

Children could injure themselves if they adjust the steering wheel.

- ▶ Never leave children unattended in the vehicle.
- ▶ When leaving the vehicle, always take the SmartKey with you and lock the vehicle.

The steering wheel can be adjusted when the power supply is disconnected.

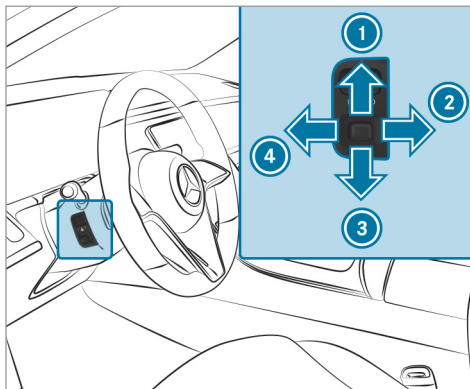

- ① To move up
- ② To move back
- ③ To move down
- ④ To move forward

- ▶ Save the settings with the memory function (→ page 130).

Switching the steering wheel heater on/off

Requirements:

- The power supply or the ignition is switched on.

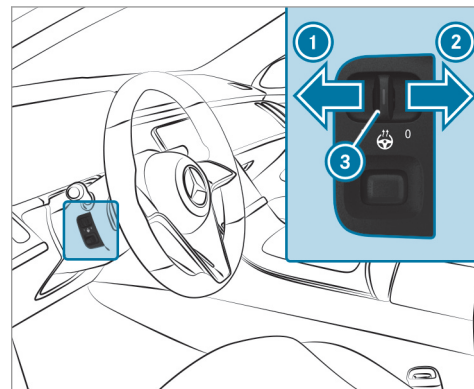

- ▶ Push the switch into position ① or ②. If indicator lamp ③ lights up, the steering wheel heater is switched on.

When you switch the ignition off, the steering wheel heater will switch off.

Coupling the steering wheel heater to the seat heating

Requirements:

- The power supply or the ignition is switched on.

Multimedia system:

→  ▶▶ Comfort ▶▶ Seat
▶▶ Heating Settings

- ▶ Tap on **Additional Steering Wheel Heating**.
The steering wheel heater will be coupled to the seat heating.

When the function has been activated, the steering wheel heater is automatically activated and deactivated when you switch the switch the seat heating on and off.

Easy entry and exit feature

Using the easy entry and exit feature

- ⚠ **WARNING** Risk of accident when pulling away during the adjustment process for the easy exit feature

You could lose control of the vehicle.

- ▶ Always wait until the adjustment process is complete before pulling away.

- ⚠ **WARNING** Risk of becoming trapped during adjustment of the easy entry and exit feature

You and other vehicle occupants could become trapped.

- ▶ Ensure that no one has a body part in the sweep of the seat or steering wheel.
- ▶ Move the adjustment lever of the steering wheel if there is a risk of becoming trapped by the steering wheel.
The adjustment process is stopped.

- ▶ If there is a risk of becoming trapped by the driver's seat, press the seat adjustment switches.
The adjustment process is stopped.

You can stop the adjustment process by pressing one of the memory function position switches.

- ⚠ **WARNING** Risk of becoming trapped if children activate the easy entry and exit feature-

Children could become trapped if they activate the easy entry- and exit feature, particularly when unattended.

- ▶ Never leave children unattended in the vehicle.
- ▶ When leaving the vehicle, always take the SmartKey with you and lock the vehicle.

In order to use the easy entry and exit feature, the automatic seat adjustment function must have been switched on (→ page 122).

If the easy entry and exit feature is active, the steering wheel will move upwards and the driver's seat will move back in the following situations:

- You switch the ignition off with the driver's door open
- You open the driver's door with the ignition switched off

i The steering wheel will then move upwards only if it is not already as high as it will go. The driver's seat will then move backwards only if it is not already at the rear of the seat adjustment range.

The steering wheel and the driver's seat will move back to the last drive position in the following cases:

- You switch the power supply or the ignition on when the driver's door is closed
- You close the driver's door with the ignition switched on

The last drive position will be saved when:

- You switch the ignition off.

- You call up the seat settings via the memory function.
- You save the seat settings via the memory function.

If you press one of the memory function memory position switches, the adjustment process will be stopped.

Setting the easy entry and exit feature

Requirements:

- The automatic seat adjustment has been activated (→ page 122).

Multimedia system:

→  » Settings » Vehicle » Comfort » Easy Entry And Exit Feature

 Select **Steering Wheel & Seat, Steering Wheel Only** or **Off**.

i If you are using an individual user profile, this information is used for the easy entry and exit feature. This will cause the driver's seat and steering wheel to move into the correct position automatically .

Memory function

Function of the memory function

⚠ WARNING Risk of an accident if the memory function is used while driving

If you use the memory function on the driver's side while driving, you could lose control of the vehicle as a result of the adjustments being made.

▶ Only use the memory function on the driver's side when the vehicle is stationary.

⚠ WARNING Risk of entrapment when adjusting the seat with the memory function

When the memory function adjusts the seat, you and other vehicle occupants – particularly children – could become trapped.

▶ During the adjusting process of the memory function, ensure that no body

parts are in the area of movement of the seat or the steering wheel.

- ▶ If someone becomes trapped, press a preset position button or seat adjustment switch immediately. The adjustment process is stopped.

⚠ WARNING Risk of entrapment if the memory function is activated by children

Children could become trapped if they activate the memory function, particularly when unattended.

- ▶ Never leave children unattended in the vehicle.
- ▶ When leaving the vehicle, always take the SmartKey with you and lock the vehicle.

You can use the memory function when the ignition is switched off.

Seat adjustments for up to three people can be stored and called up using the memory function.

You can save the following settings for the front seat:

- Seat, backrest, head restraint position and contour of the seat backrest in the lumbar region
- **Vehicles with an active multicontour seat:**
 - Side bolsters of the seat backrest
 - Shoulder of the seat backrest
 - Contour of the seat backrest
 - Dynamic function level
- Seat heating: distribution of the heated sections of the seat cushion and seat backrest
- Driver's side: steering wheel position and position of the outside mirrors on the driver's and front passenger sides
- Head-up Display (depending on vehicle equipment)

Operating the memory function

Storing

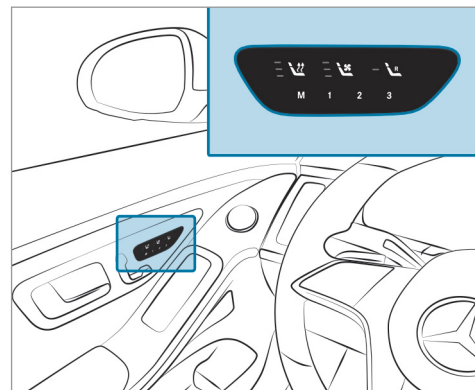

- ▶ Set the seat, the steering wheel, the Head-up Display and the outside mirror to the desired position.
- ▶ Press the **M** memory button and then release it.

- ▶ Press one of the preset position buttons **1**, **2** or **3** within three seconds. An acoustic signal sounds. The settings are stored.
 - ▶ **To call up:** press the preset position button **1**, **2** or **3**. The seat is moved to the stored position. After releasing the button, the front seat, outside mirror, Head-up Display and steering column continue to move into the stored position automatically.
- i Driver's seat:** to call up a stored position while driving, you must press and hold the preset position button.

Memory function in the rear passenger compartment

Function of the memory function in the rear passenger compartment

Operating the rear seat

Rear seat settings for up to three people can be stored and called up using the memory function in the rear passenger compartment.

You can save the following settings for the rear seat:

- Position of the seat, backrest and head restraint
- **Vehicles with active multicontour seats:** The seat side bolsters of the seat backrest as well as the contour of the seat backrest in the lumbar region
- Seat heating: distribution of the heated sections of the seat cushion and seat backrest

Operating the front passenger seat and rear seat

Front passenger seat adjustments and rear seat adjustments for up to three people can be stored and called up using the memory function in the rear passenger compartment.

You can save the following settings for the front passenger seat:

- Position of the seat, backrest and head restraint

You can save the following settings for the rear seat:

- Position of the seat, backrest and head restraint
- **Vehicles with active multicontour seats:** The seat side bolsters of the seat backrest as well as the contour of the seat backrest in the lumbar region
- Seat heating: distribution of the heated sections of the seat cushion and seat backrest

The following settings are also stored to a memory position, if the indicator lamp in the  button lights up:

- Position of the footrest of the front passenger seat, if available
- Position of the screen, if available

Using the preset position buttons, you always store the current setting of each seat.

Operating the rear seat via the memory function in the rear passenger compartment

Storing

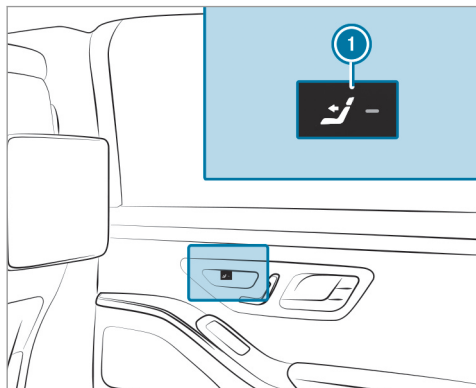

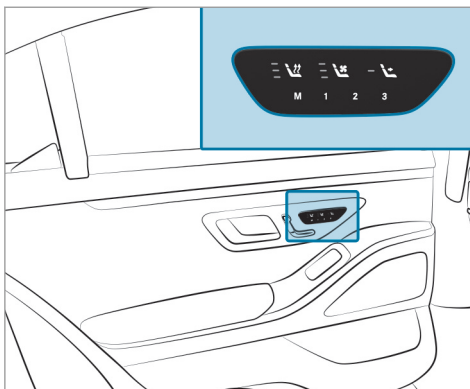

- ▶ Press button ①.
The rear seat is selected if the indicator lamp in the button does not light up.
- ▶ Adjust the rear seat using the buttons in the door control panel (→ page 111).



Example: vehicles without a reclining rear seat

- ▶ Press the **M** button and then release it.
- ▶ **Vehicles without reclining rear seat:** Press one of the preset position buttons **1**, **2** or **3** within three seconds. The settings are stored.

- ▶ **Vehicles with reclining rear seat:** Press one of the preset position buttons **1** or **2** within three seconds. The settings are stored.

- ⓘ **Vehicles with reclining rear seat:** You cannot store any settings on the  and  buttons for adjusting the reclined and standard positions.

Calling up

- ▶ Press button ①.
The rear seat is selected if the indicator lamp in the button does not light up.
- ▶ **Vehicles without reclining rear seat:** Press preset position button **1**, **2** or **3**. The seat is moved to the stored position. After releasing the button, the rear seat is automatically moved into the stored position.
- ▶ **Vehicles with reclining rear seat:** Press one of preset position buttons **1** or **2**. The seat is moved to the stored position. After releasing the button, the rear seat is automatically moved into the stored position.

Operating the front passenger seat and rear seats via the memory function in the rear passenger compartment

Storing

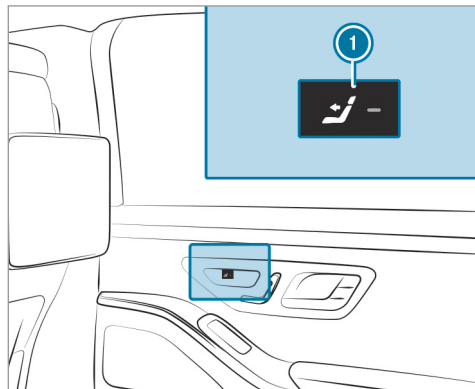

- ▶ Press button ①.
The rear seat is selected if the indicator lamp in the button does not light up.

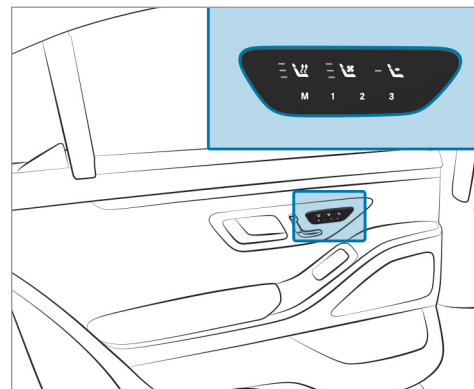

- ▶ Adjust the rear seat using the buttons in the door control panel (→ page 111).
- ▶ Press button ①.
When the indicator lamp lights up, the front passenger seat is selected.
- ▶ Adjust the front passenger seat using the buttons on the door control panel in the rear passenger compartment (→ page 106).
- ▶ Ensure that the indicator lamp in button ① lights up.



Example: vehicles without a reclining rear seat

- ▶ Press the **M** button and then release it.
- ▶ **Vehicles without reclining rear seat:** Press one of the preset position buttons **1**, **2** or **3** within three seconds.
The settings for the front passenger seat and the rear seat are stored in the selected pre-set position.

▶ **Vehicles with reclining rear seat:** Press one of the preset position buttons **1** or **2** within three seconds. The settings for the front passenger seat and the rear seat are stored in the selected preset position.

① **Vehicles with reclining rear seat:** You cannot store any settings on the  and  buttons for adjusting the reclined and standard positions.

Calling up

▶ Press button **1**.
When the indicator lamp lights up, the front passenger seat is selected.

▶ **Vehicles without reclining rear seat:** Press one of preset position buttons **1**, **2** or **3**.
The seat is moved to the stored position. After releasing the button, the front seat and rear seat are moved automatically into the stored position.

▶ **Vehicles with reclining rear seat:** Press one of preset position buttons **1** or **2**. The seat is moved to the stored position. After releasing the button, the front seat and rear seat are moved automatically into the stored position.

① The preset positions in the area for chauffeur mode can only be set when the conditions for chauffeur mode are fulfilled (→ page 114).

① You can use the rear-compartment child safety lock to disable this function (→ page 75).

Stowage areas

Notes on loading the vehicle

⚠ DANGER Risk of exhaust gas poisoning

Combustion engines emit poisonous exhaust gases such as carbon monoxide. Exhaust gases can enter the vehicle interior if the trunk lid is open when the engine is running, especially if the vehicle is in motion.

- ▶ Always switch off the engine before opening the trunk lid.
- ▶ Never drive with the trunk lid open.

Objects in the deployment area of an airbag may prevent the airbag from functioning correctly.

Observe the notes on protection provided by the airbag (→ page 51).

Vehicles with rear airbag: Also observe the notes on the rear airbag (→ page 57).

⚠ WARNING Risk of injury from unsecured items in the vehicle

If objects, luggage or loads are not secured or not secured sufficiently, they could slip, tip over or be thrown around and thereby hit vehicle occupants.

There is a risk of injury, particularly in the event of sudden braking or a sudden change in direction.

- ▶ Always stow objects in such a way that they cannot be thrown around.

- ▶ Before the journey, secure objects, luggage or loads against slipping or tipping over.

⚠ WARNING Risk of injury due to objects being stowed incorrectly

If objects in the vehicle interior are stowed incorrectly, they can slide or be thrown around and hit vehicle occupants. In addition, cup holders, open storage spaces and mobile phone brackets cannot always retain all objects they contain.

There is a risk of injury, particularly in the event of sudden braking or a sudden change in direction.

- ▶ Always stow objects in such a way that they cannot be thrown around in such situations.
- ▶ Always make sure that objects do not protrude from storage spaces, parcel nets or storage nets.
- ▶ Close the lockable storage spaces before starting a journey.

- ▶ Always stow and secure heavy, hard, pointed, sharp-edged, fragile or bulky objects in the trunk.

Observe the notes on the cup holders.

Vehicles with automatic front passenger airbag shutoff: Objects trapped under the front passenger seat may interfere with the function of the automatic front passenger airbag shutoff or damage the system. Please observe the notes on the function of the automatic front passenger airbag shutoff (→ page 53).

! NOTE Damage to the rear armrest due to body weight

When folded out, the rear armrest can be damaged by body weight.

- ▶ Do not sit or support yourself on the rear seat armrest.

⚠ WARNING - Risk of accident or injury when using the cup holder while the vehicle is moving

The cup holder cannot secure containers while the vehicle is moving.

If you use a cup holder while the vehicle is moving, the container may be flung around and liquids may be spilled. The vehicle occupants may come into contact with the liquid and if it is hot, they could be scalded. You could be distracted from traffic conditions and you may lose control of the vehicle.

- ▶ Only use the cup holder when the vehicle is stationary.
- ▶ Only use the cup holder for containers of the right size.
- ▶ Close the container, particularly if the liquid is hot.

! NOTE Damage to the cup holder

When the rear armrest is folded back the cup holder could become damaged.

- ▶ Only fold the rear armrest back when the cup holder is closed.

! **NOTE** Damage to the stowage compartment under the ashtray due to intense heat

The stowage compartment under the ashtray is not heat resistant and could be damaged if you rest a lit cigarette on it.

- ▶ Make sure that the ashtray is fully engaged.

! **WARNING** - Risk of fire and injury from hot cigarette lighter

You can burn yourself if you touch the hot heating element or the socket of the cigarette lighter.

In addition, flammable materials may ignite if:

- you drop the hot cigarette lighter
- a child holds the hot cigarette lighter to objects, for example

- ▶ Always hold the cigarette lighter by the knob.
- ▶ Always make sure that the cigarette lighter is out of reach of children.
- ▶ Never leave children unattended in the vehicle.

! **WARNING** Risk of burns from the tailpipe and tailpipe trims

The exhaust tailpipe and tailpipe trims can become very hot. If you come into contact with these parts of the vehicle, you could burn yourself.

- ▶ Always be particularly careful around the tailpipe and the tailpipe trims and supervise children especially closely in this area.
- ▶ Allow vehicle parts to cool down before touching them.

The driving characteristics of your vehicle are dependent on the distribution of the load within the vehicle. You should bear the following in mind when loading the vehicle:

- Never exceed the permissible gross mass or the gross axle weight rating for the vehicle (including occupants). The values are specified on the vehicle identification plate on the vehicle's B-pillar.
- The load must not protrude above the upper edge of the seat backrests.
- Always place the load behind unoccupied seats if possible.
- Secure the load using the parcel net hooks. Distribute the load on the parcel net hooks evenly.

Notes on driving with a roof load

- Evenly distribute the roof load, and place heavy objects at the bottom. Also comply with the notes on loading the vehicle (→ page 134).

- Drive attentively, and avoid suddenly pulling away, braking and steering as well as rapid cornering.
- When transporting roof loads and when the vehicle is fully loaded or fully occupied, select drive programs **E** and **C**. These are designed to focus on stability (→ page 201).

i For more information on storage compartments and storage areas, please refer to the Digital Operator's Manual.

Stowage spaces in the vehicle interior

Overview of the front storage compartments

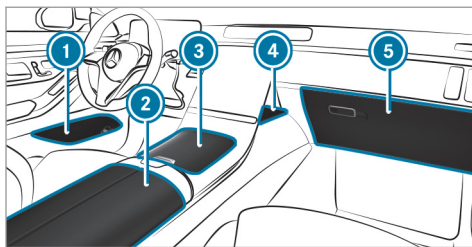

- 1 Storage spaces in the doors
- 2 Storage and telephone compartment beneath the armrest with a charging module for wireless charging of mobile phones, multimedia and USB ports as well as storage space, e.g. for an MP3 player
- 3 Storage compartment in the front center console with cup holders, USB ports and charging module for wireless charging of mobile phones
- 4 Storage compartment in front of the central display of the multimedia system
- 5 Glove box

i The rubber mat in the storage compartment in front center console **3** can be removed for cleaning with clear, lukewarm water. Please comply with the notes on caring for the interior (→ page 348).

Folding the folding table out or in

⚠ WARNING Risk of injury from an open folding table

Vehicle occupants may bump into the folding table and injure themselves.

▶ Close the folding table before each journey.

! NOTE Damage to the folding tables when moving the seats back

Open folding tables may be damaged when the seats are moved back.

▶ Make sure that the folding tables are folded in when moving the front seats back.

NOTE Damage to objects when the folding tables are expanded or collapsed

Objects such as tablets and displays can be damaged when the folding tables are expanded or collapsed.

- ▶ Make sure that the folding tables are expanded and collapsed properly.

Folding out

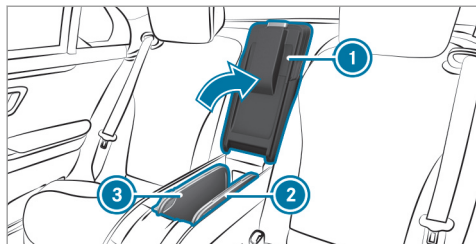

- ▶ Opening the storage compartment (1) in the center console of the rear passenger compartment

- ▶ Pull folding table (2) up and forwards by handle recess (3) and swing it outwards.

- ▶ Fold the table panels apart.

(i) The table panels can be rotated forwards or backwards to bring them into a comfortable position for the vehicle occupants in the rear passenger compartment.

- ▶ **To fold in:** fold the table panels together and swing in the folding table.

Removing the handset from the rear storage compartment

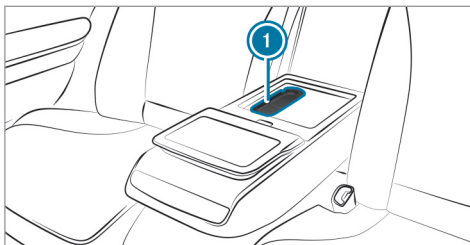

Vehicles with electrically adjustable outer rear seats

- ▶ Fold down the rear armrest.
- ▶ Open the storage compartment in the rear armrest .
- ▶ Tap handset (1).
- ▶ Handset (1) will rise.
- ▶ Remove handset (1).

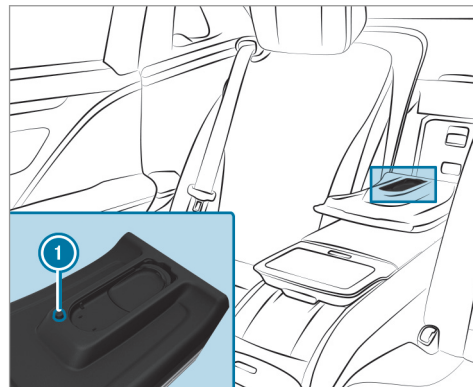

Vehicles with individual rear seats

- ▶ Open the storage box in the rear-compartment backrest.
- ▶ Press button ❶.
- ▶ Remove the handset.

Overview of the parcel net hooks

Observe the following notes:

- Secure the load using the parcel net hooks.
- Do not use elastic straps or nets to secure a load. These are intended only as anti-slip protection for light loads.
- Do not route tie downs across sharp edges or corners.
- Pad sharp edges for protection.

Depending on the equipment installed, the trunk contains up to four parcel net hooks.

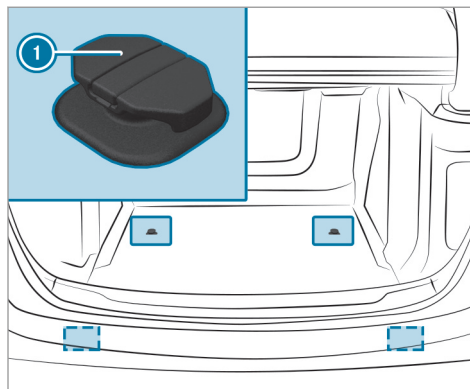

❶ Parcel net hooks

Opening the through-loading feature in the rear passenger compartment

Requirements:

- The loading flap is unlocked (→ page 141).

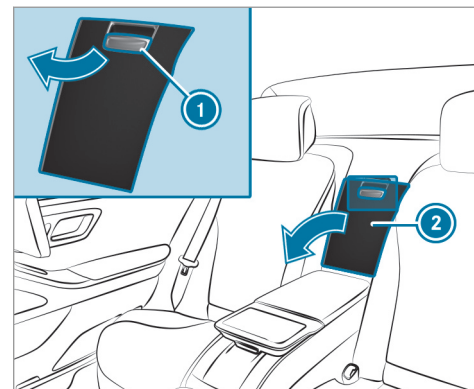

Vehicles with individual rear seats

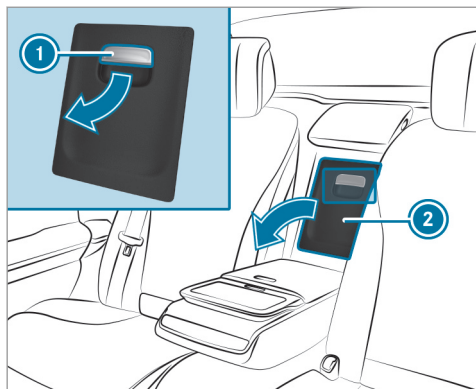

Vehicles with electrically adjustable outer rear seats

- ▶ **Vehicles with electrically adjustable outer seats:** Fold down the rear armrest.
- ▶ Pull handle ① and fold down cover ②. The storage box in the rear passenger compartment backrest will be opened.

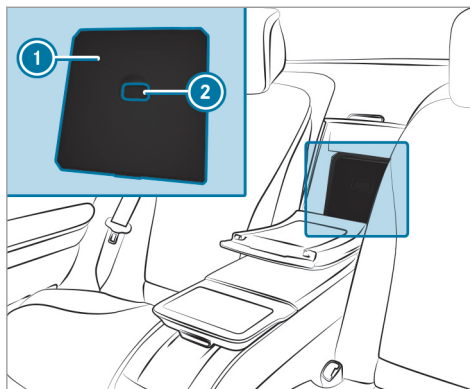

Vehicles with individual rear seats

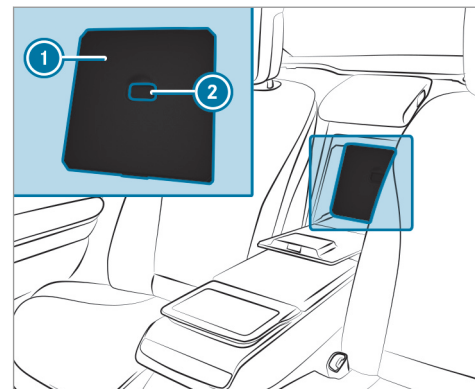

Vehicles with electrically adjustable outer rear seats

- ▶ Slide release catch ② in the handle recess of loading flap ① upwards. Loading flap ① will be unlocked.

- ▶ Push loading flap ① with release catch ② up as far back as possible until the flap locks in the highest position.

The through-loading feature in the rear passenger compartment will be opened.

If the through-loading feature is to be used as a storage compartment again:

- ▶ Fold down loading flap ① and lock it in the trunk (→ page 141).

Locking the through-loading feature in the trunk

Requirements:

- The refrigerator box is removed.

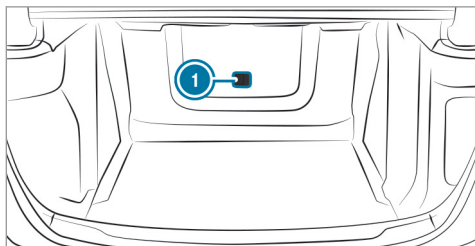

- ▶ Slide the release catch on loading flap ① in the trunk to the right. The loading flap is locked.

Using the bag hooks

- ⚠ **WARNING** Risk of injury when using bag hooks with heavy objects

The bag hooks cannot restrain heavy objects or items of luggage.

Objects or items of luggage may be flung around and hit vehicle occupants.

- ▶ Only hang light objects on the bag hooks.
- ▶ Never hang hard, sharp-edged or fragile objects on the bag hooks.

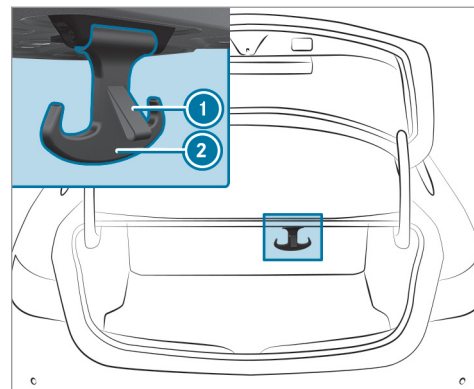

- ▶ Pull bag hook ② down by tab ①.

ⓘ Observe the notes on loading the vehicle (→ page 134).

EASY-PACK trunk box

Adjusting the height of the EASY-PACK trunk box to any position

⚠ WARNING Risk of becoming trapped and injured when raising the floor

Your hands may become trapped on the frame of the EASY-PACK trunk box and objects may be thrown upwards.

- ▶ Ensure that your hands are not in the range of movement of the floor.
- ▶ If someone becomes trapped, carefully push the center of the floor downward.
- ▶ Remove all objects from the floor before raising it.

⚠ WARNING Risk of becoming trapped when pressing the EASY-PACK trunk box in

Your hands may become trapped when you are pressing the trunk box into the retracted position. Children, in particular, may injure themselves when doing so.

- ▶ Ensure that your hands are not in the range of movement of the EASY-PACK trunk box.
- ▶ When leaving the vehicle, always take the SmartKey with you and lock the vehicle.
- ▶ Never leave children unattended in the vehicle.

! NOTE Damage to the extended EASY-PACK trunk box

The EASY-PACK trunk box may be damaged when it is extended.

- ▶ Do not place any objects on or press down on the EASY-PACK trunk box frame.
- ▶ Do not close the trunk lid when the EASY-PACK trunk box is extended.

! NOTE Damage to the EASY-PACK trunk box by objects

Objects that are sharp-edged, pointed, fragile, rounded or heavy and objects that roll can damage the EASY-PACK trunk box and be thrown out.

- ▶ Do not transport objects that are sharp-edged, pointed, rounded or fragile and objects that roll in the EASY-PACK trunk box.
- ▶ Always stow and secure such objects outside of the box in the trunk.
- ▶ Always observe the maximum permitted load of the EASY-PACK trunk box.
- ▶ Do not use the EASY-PACK trunk box when the rear seats are folded forwards.

The maximum permitted load of the EASY-PACK trunk box is 22 lbs (10 kg). To prevent the box from being overloaded, the box floor will lower onto the trunk floor when the load reaches approximately 11 lbs (5 kg).

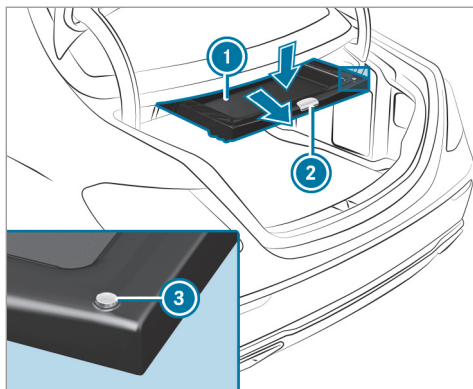

- ▶ **To remove:** pull handle ② on the box.
- ▶ **To increase the load capacity:** push the center of floor ① downwards to the desired position and box size.
- ▶ **To reduce the load capacity:** press button ③.
- ▶ **To store:** push the box in completely using handle ② until it locks in place.

ⓘ Observe the notes on cleaning the EASY-PACK trunk box (→ page 348).

Installing and removing the EASY-PACK trunk box

Installing

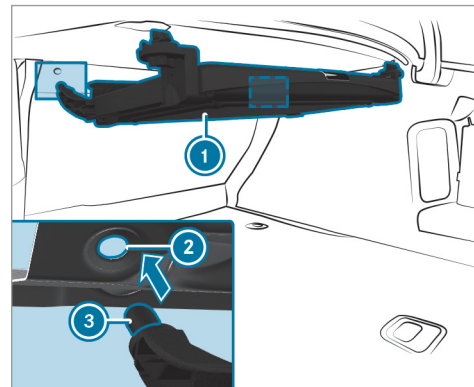

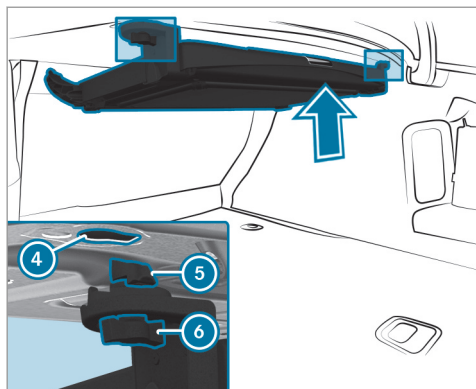

- ▶ Turn rotating catches ⑥ outward.
- ▶ Insert retainers ③ of box ① into holes ②.
- ▶ Raise box ① in the direction of the arrow and press hooks ⑤ into the anchorages of rear shelf ④.
- ▶ Turn rotating catches ⑥ inward.

Removing

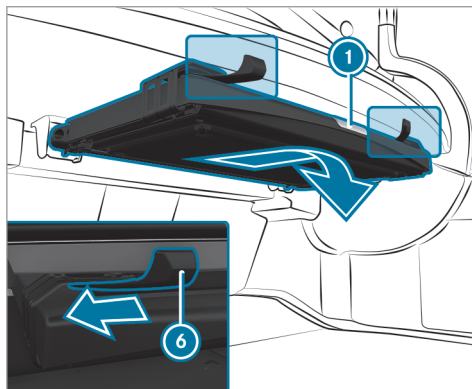

- ▶ Turn rotating catches ⑥ outward.
- ▶ Lower box ① in the direction of the arrow and pull it out of the anchorages on the rear shelf.
- ▶ Pull box ① back out of the openings in the direction of the arrow.

Attaching a roof luggage rack

⚠ WARNING Risk of accident due to exceeding the maximum roof load

The vehicle center of gravity and the usual driving characteristics as well as the steering and braking characteristics alter.

If you exceed the maximum roof load, the driving characteristics, as well as steering and braking, will be greatly impaired.

- ▶ Never exceed the maximum roof load and adjust your driving style.

You will find information on the maximum roof load in the "Technical data" section.

! NOTE Vehicle damage from non-approved roof luggage racks

The vehicle could be damaged by roof luggage racks that have not been tested and approved by Mercedes-Benz.

- ▶ Only use roof luggage racks tested and approved for Mercedes-Benz.

- ▶ Depending on the vehicle equipment, ensure that when the roof luggage rack is installed, the trunk lid can be fully opened.
- ▶ Position the load on the roof luggage rack in such a way that the vehicle will not sustain damage even when it is in motion.

! **NOTE** Damage to panorama roof with power tilt/sliding panel caused by roof luggage rack

If the panorama roof with power tilt/sliding panel is opened when a roof luggage rack is installed, the panorama roof with power tilt/sliding panel may be damaged by the roof luggage rack.

- ▶ Do not open the panorama roof with power tilt/sliding panel if a roof luggage rack is installed.

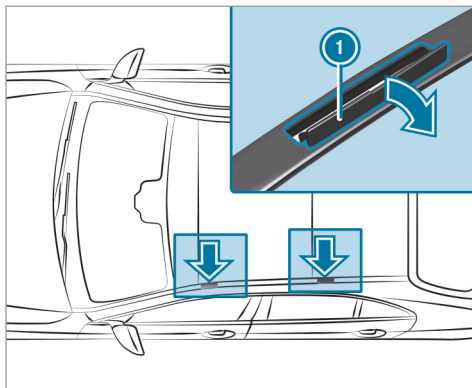

! **NOTE** Damage to the covers

The covers may be damaged and scratched when being opened.

- ▶ Do not use metallic or hard objects.

- ▶ Carefully fold covers ① upwards in the direction of the arrow.

- ▶ Secure the roof luggage rack to the fastening points beneath covers ①.
- ▶ Comply with the installation instructions of the roof luggage rack manufacturer.
- ▶ Secure the load on the roof luggage rack.

Cup holder

Switching the cooling or heating function for the temperature-controlled cup holder on or off

When the heating function is used, the metal insert of the cup holder is heated. For this reason, you must not reach into the cup holder insert.

When placing glasses in the temperature-controlled cup holder, do not close the cover of the storage compartment in the rear center console because the glasses may tip over.

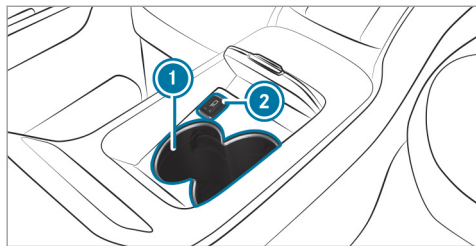

▶ **To switch on:** press button ② until the blue (keep cool) or red (keep warm) indicator lamp on the button lights up.

▶ **To switch off:** press button ② until the indicator lamp on the button goes out.

① Clean the removable rubber mat only with clean, lukewarm water and the temperature-controlled cup holder ① only with a soft cloth.

Sockets

Using the 12 V socket

Requirements:

- Only connect devices up to a maximum of 180 W (15 A).

Depending on the vehicle equipment, the vehicle has the following 12 V sockets:

- In the front passenger footwell
- On vehicles with a rear bench seat or electrically adjustable outer seats: in the electronics compartment of the rear center console
- On vehicles with individual rear seats: in the storage compartment of the rear center console
- In the trunk

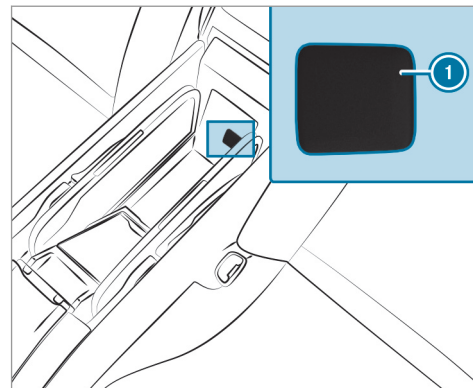

Example: 12 V socket in the rear center console

- ▶ Fold up socket cap ①.
- ▶ Insert the plug of the device.

If you have connected a device to the 12 V socket, leave the cover of the storage compartment open.

Using the 115 V socket in the rear passenger compartment passenger compartment

⚠ DANGER Risk of fatal injury due to damaged connecting cables or sockets

You could receive an electric shock if the connecting cable or the 115 V power socket is pulled out of the trim or is damaged or wet.

- ▶ Use only connecting cables that are dry and free of damage.
- ▶ When the ignition is switched off, make sure that the 115 V power socket is dry.
- ▶ Immediately have the 115 V power socket checked or replaced at a qualified specialized workshop if it is damaged or has been pulled out of the trim.
- ▶ Never plug the connecting cable into a 115 V power socket that is damaged or has been pulled out of the trim.

⚠ DANGER Risk of fatal injury due to incorrect handling of the socket

You could receive an electric shock in particular:

- If you reach into the socket.
 - If you insert unsuitable devices or objects into the socket.
- ▶ Do not reach into the socket.
 - ▶ Only connect suitable devices to the socket.

Requirements:

- Only connect devices with a suitable plug which conforms to the standards specific to the country you are in.
 - Do not use multiple socket outlets.
- i** Only devices up to a maximum of 150 watts (1.3 A) can be connected.

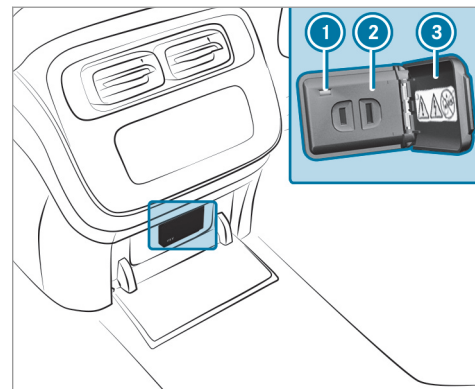

Vehicles with a rear bench seat or electrically adjustable outer seats in the rear passenger compartment

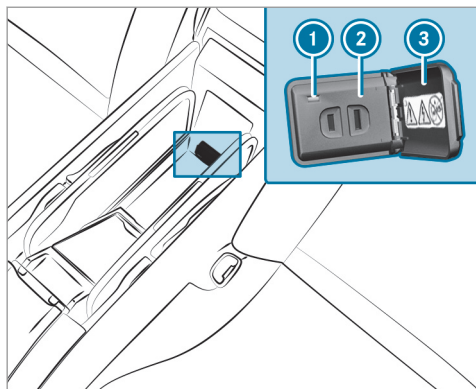

Vehicles with individual rear seats

- ▶ **Vehicles with a rear passenger compartment bench seat or electrically adjustable outer seats:** open the electronics compartment in the rear passenger compartment center console.
- ▶ **Vehicles with individual rear passenger compartment seats:** open the stowage

- ▶ compartment in the rear passenger compartment center console.
- ▶ Open socket flap ③.
- ▶ Insert the plug of the device into 115 V socket ②.
When the on-board electrical system voltage is sufficient, indicator lamp ① lights up.

USB port in the rear passenger compartment

Depending on the vehicle equipment, the vehicle has the following USB ports in the rear passenger compartment:

- On vehicles with individual rear seats: in the storage compartment of the rear passenger compartment center console .
- On vehicles with a rear bench seat or electrically adjustable outer rear seats: in the electronics compartment in the rear passenger compartment center console .
- On vehicles with a rear bench seat or electrically adjustable outer rear seats: in the storage compartment in the rear armrest .

- ⓘ These USB ports in the rear passenger compartment can be used to charge a mobile end device.

You can charge a USB device, such as a mobile phone, at the USB ports using a suitable charging cable. Depending on the vehicle equipment, the devices can be charged with up to 20 V (5 A) when the ignition is switched on.

Refrigerator box

Using the refrigerator box

⚠ WARNING Risk of fire due to a covered vent grille on the refrigerator box

If you cover the vent grille for the refrigerator box, it may overheat.

- ▶ Always make sure that the vent grille is not covered.

The vent grille for the refrigerator box is in the trunk.

The refrigerator box can bear a maximum load of 7.7 lb (3.5 kg).

The upper compartment of the refrigerator box can accommodate, for example, plastic bottles with a maximum capacity of 17 fl. oz. (0.5 liters) and cans with a capacity of up to 11 fl. oz. (0.33 liters)

If you do not need to use the refrigerator box for an extended period, you should switch it off, defrost it and clean it. After doing so, leave the lid open for a time.

More condensation may occur during intensive use. Cleaning may be required.

The refrigerator box will reduce its cooling capacity or switch off in the following cases:

- Too many electrical consumers are turned on.
- The starter battery is not sufficiently charged.

If this is the case, the indicator lamps will flash on the button for switching the refrigerator box on and off. The cooling function will automatically switch back on as soon as there is sufficient voltage.

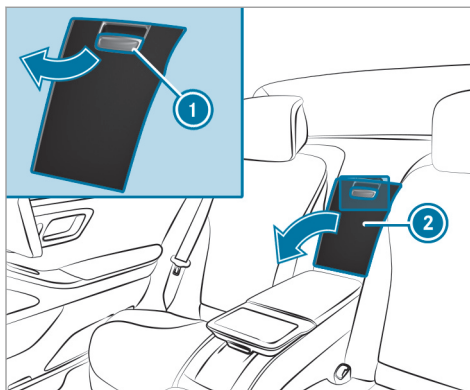

Example: vehicles with individual rear seats

- ▶ Vehicles with electrically adjustable outer seats: fold down the rear armrest.
- ▶ Pull handle ① on storage box and fold down cover ② of storage box.

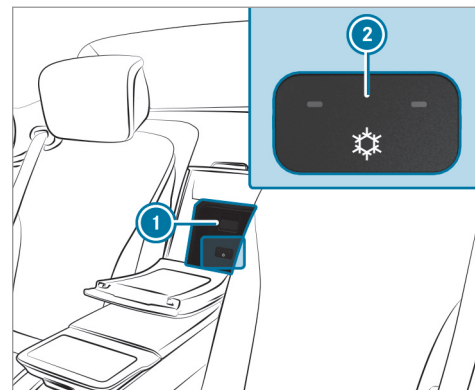

Example: vehicles with individual rear seats

- ▶ **To open:** pull the handle on refrigerator box ① and fold down the cover of the refrigerator box.
- ▶ **To switch on:** press button ② repeatedly until an indicator lamp (low cooling) lights up or two indicator lamps (high cooling) light up.

- ▶ **To switch off:** press button ② repeatedly until both indicator lamps go out.

Removing or installing the refrigerator box

Installing

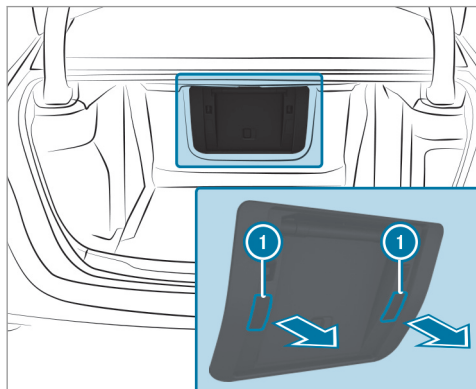

- ▶ Remove cover cap ①.

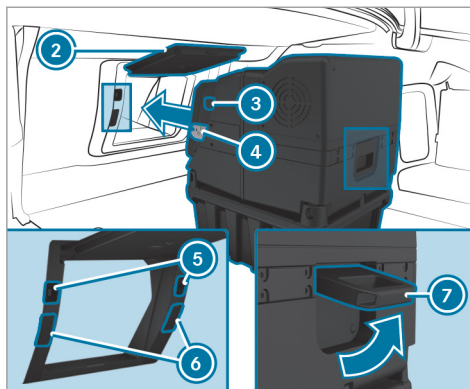

- ▶ Open loading flap ② in the rear passenger compartment until the loading flap locks in the highest position (→ page 139).
- ▶ Pull upwards and hold handle ⑦. The connection to refrigerator box ④ is unlocked.

- ▶ Slide the refrigerator box with handle ⑦ up into the open through-loading feature. Connection ④ and the electrical contacts of refrigerator box ③ are inserted into sockets ⑤ and ⑥ of the through-loading feature.
- ▶ Once the refrigerator box has been connected in the vehicle, push down handle ⑦. The refrigerator box is locked.

Removing

- ▶ Pull up and hold handle ⑦.
- ▶ Pull the refrigerator box with handle ⑦ up out of sockets ⑤ and ⑥ of the through-loading compartment. Connection ④ and the electrical contacts of refrigerator box ③ are separated from sockets ⑤ and ⑥ of the through-loading feature.

Opening and closing the stowage compartment of the refrigerator box in the trunk

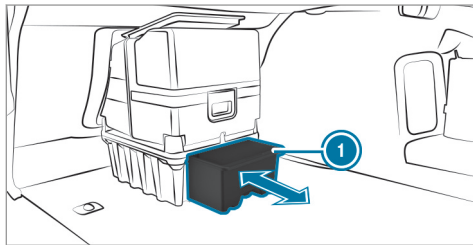

- ▶ **To open:** pull the stowage compartment in refrigerator box ① out by the handle backwards in the direction of the arrow. Stowage compartment ① is open.
- ▶ **To close:** slide the stowage compartment in refrigerator box ① forwards in the direction of the arrow. Stowage compartment ① is closed.

Wireless charging of the mobile phone and connection with the exterior antenna

Notes on wirelessly charging the mobile phone

⚠ WARNING Risk of injury due to objects being stowed incorrectly

If objects in the vehicle interior are stowed incorrectly, they can slide or be thrown around and hit vehicle occupants. In addition, cup holders, open stowage spaces and mobile phone receptacles cannot always retain all objects within.

There is a risk of injury, particularly in the event of sudden braking or a sudden change in direction.

- ▶ Always stow objects so that they cannot be thrown around in such situations.
- ▶ Always make sure that objects do not protrude from stowage spaces, parcel nets or stowage nets.

- ▶ Close the lockable stowage spaces before starting a journey.
- ▶ Always stow and secure heavy, hard, pointed, sharp-edged, fragile or bulky objects in the trunk/cargo compartment.

Observe the notes on loading the vehicle.

⚠ WARNING Risk of fire from placing objects in the mobile phone storage compartment

Placing other objects in the mobile phone storage compartment could constitute a fire hazard.

- ▶ Apart from a mobile phone, do not place any other objects in the mobile phone storage compartment, especially those made of metal.

! **NOTE** Damage to objects caused by placing them in the mobile phone storage compartment

If objects are placed in the mobile phone storage compartment, they may be damaged by electromagnetic fields.

- ▶ Do not place credit cards, data storage devices, ski passes or other objects sensitive to electromagnetic fields in the mobile phone storage compartment.

! **NOTE** Damage to the mobile phone stowage compartment caused by liquids

If liquids enter the mobile phone stowage compartment, the compartment may be damaged.

- ▶ Ensure that no liquids enter the mobile phone stowage compartment.

Always observe the notes for persons with electronic medical aids (→ page 34).

- Depending on the vehicle equipment, the mobile phone is connected to the vehicle's exterior antenna via the charging module.
- The charging function and wireless connection of the mobile phone to the vehicle's exterior antenna are only available if the ignition is switched on.
- Small mobile phones may not be able to be charged in every position of the mobile phone storage compartment.
- Large mobile phones which do not rest flat in the mobile phone storage compartment may not be able to be charged or connected with the vehicle's exterior antenna.
- The mobile phone may heat up during the charging process. This may also depend on the applications (apps) currently open in the background.
- To ensure more efficient charging and connection with the vehicle's exterior antenna, remove the protective cover from the mobile phone. Protective covers which are necessary for wireless charging are an exception.

Wirelessly charging a mobile phone in the front

Requirements:

- The mobile phone is suitable for wireless charging.

A list of compatible mobile phones can be found at: <https://www.mercedes-benz-mobile.com/>

Depending on the vehicle's equipment, the vehicle has the following options for wirelessly charging a mobile phone in the cockpit:

- In the front storage compartment
- In the storage compartment of the cockpit armrest

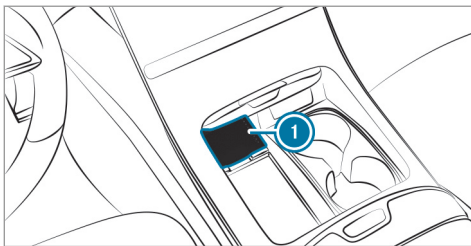

Example: wirelessly charging a mobile phone in the front storage compartment

- ▶ Place the mobile phone as close to the center of mat ① as possible with the display facing upwards.

Wirelessly charging a mobile phone in the front storage compartment: when a message is shown in the multimedia system, the mobile phone is being charged. In addition, malfunctions during the mobile phone's charging process are shown in the multimedia system display.

Wirelessly charging a mobile phone in the center console below the armrest: the mobile phone is charging when the indicator lamp is lit.

In addition, malfunctions during the mobile phone's charging process are shown by the indicator lamp flashing three times.

- ① The mat can be removed for cleaning, e.g. using clean, lukewarm water.

Wirelessly charging a mobile phone in the rear passenger compartment passenger compartment



Example: vehicles with individual rear passenger compartment seats

- ▶ Open the stowage compartment in the rear passenger compartment center console.
- ▶ Place the mobile phone as close to the center of mat ① as possible with the display facing upwards. When the indicator lamp at the front of the mobile phone system lights up, the mobile phone is being charged. In addition, malfunctions during the mobile phone's charging process are shown by the indicator lamp flashing three times.

Requirements:

- The mobile phone is suitable for wireless charging.
A list of compatible mobile phones can be found at: <https://www.mercedes-benz-mobile.com/>

154 Seats and stowing

- ① The mat can be removed for cleaning, e.g. using clean, lukewarm water.
- ① Observe the notes on loading the vehicle (→ page 134).

Installing and removing the floor mats

⚠ WARNING Risk of accident due to objects in the driver's footwell

Objects in the driver's footwell may impede pedal travel or block a depressed pedal.

This jeopardizes the operating and road safety of the vehicle.

- ▶ Stow all objects in the vehicle securely so that they cannot get into the driver's footwell.
- ▶ Always install the floor mats securely and as prescribed in order to ensure that there is always sufficient room for the pedals.
- ▶ Do not use loose floor mats and do not place floor mats on top of one another.

Installing floor mats

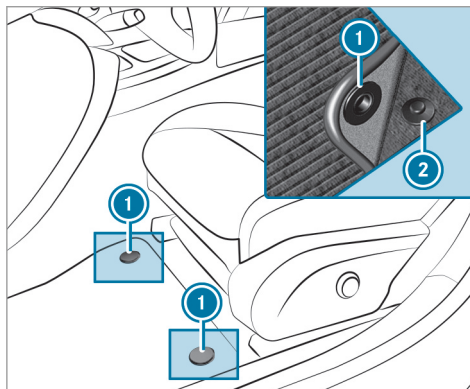

- ▶ Slide the corresponding seat backwards and lay the floor mat in the footwell such that it fits.
- ▶ Press studs ① onto holders ②.
- ▶ Adjust the corresponding seat.

Removing floor mats

- ▶ Slide the corresponding seat backwards and pull the floor mat off holders ②.
- ▶ Adjust the corresponding seat.

Exterior lighting

Information about lighting systems and your responsibility

The various lighting systems of the vehicle are only aids. The driver of the vehicle is responsible for correct vehicle illumination in accordance with the prevailing light and visibility conditions, legal requirements and traffic situation.

Light switch

Operating the light switch

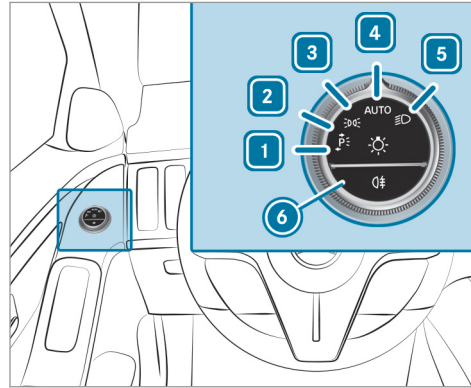

- 1 Left-hand standing lights
- 2 Right-hand standing lights
- 3 Parking lights and license plate lamp
- 4 **AUTO** Automatic driving lights (preferred light switch position)

- 5 Low beam/high beam
- 6 Switches the rear fog light on/off

When low beam is activated, the indicator lamp for the parking lights will be deactivated and replaced by the low-beam indicator lamp.

▶ Always park your vehicle safely using sufficient lighting, in accordance with the relevant legal stipulations.

! **NOTE** Battery discharging by operating the standing lights

Operating the standing lights over a period of hours puts a strain on the battery.

▶ Where possible, switch on the right or left parking light.

If the battery is insufficiently charged, the standing lights or parking lights will be switched off automatically to facilitate the next engine start.

The exterior lighting (except standing and parking lights) will switch off automatically when the driver's door is opened.

- Observe the notes on surround lighting (→ page 165).

Automatic driving lights function

The parking lights, low beam and daytime running lights are switched on automatically depending on the ignition status and the ambient light.

⚠ WARNING Risk of accident when the low beam is switched off in poor visibility

When the light switch is set to **AUTO**, the low beam may not be switched on automatically if there is fog, snow or other causes of poor visibility such as spray.

- ▶ In such cases, turn the light switch to .

The automatic driving lights are only an aid. You are responsible for vehicle lighting.

Switching the rear fog lights on or off

Requirements:

- The light switch is in the  or **AUTO** position.

- ▶ Press the  button.

Please observe the country-specific laws on the use of rear fog lamps.

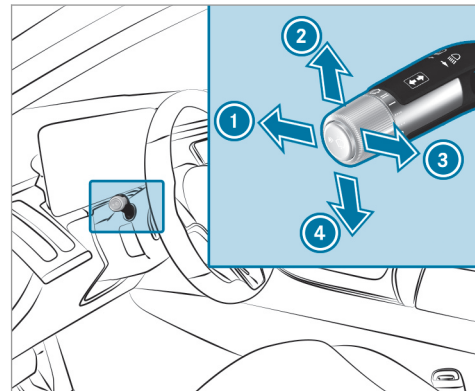

Operating the combination switch for the lights



- ① High beam
- ② Turn signal light, right
- ③ High-beam flasher
- ④ Turn signal light, left

- ▶ Use the combination switch to activate the desired function.

Switching on high beam

- ▶ Turn the light switch to the  or **AUTO** position.
- ▶ Push the combination switch in the direction of arrow ①. When the high beam is activated, the  indicator lamp for low beam will be deactivated and replaced by the  indicator lamp for high beam.

Switching off high beam

- ▶ Push the combination switch in the direction of arrow ① or pull it in the direction of arrow ③.

High-beam flasher

- ▶ Pull the combination switch in the direction of arrow ③.

Turn signal light

- ▶ **To indicate briefly:** push the combination switch briefly to the point of resistance in the direction of arrow ② or ④. The corresponding turn signal light will flash three times.

▶ **To indicate permanently:** push the combination switch beyond the point of resistance in the direction of arrow ② or ④.

Vehicles with Active Lane Change Assist:

- A turn signal indicator activated by the driver may continue to operate for the duration of the lane change.
- If the driver indicated directly beforehand but a lane change was not immediately possible, the turn signal indicator may activate automatically.

Activating/deactivating the hazard warning lights

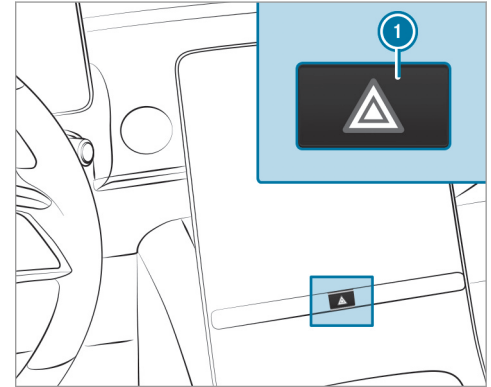

- ▶ Press button ①.

The hazard warning lights will switch on automatically if:

- The airbag has been deployed.

Adaptive functions MULTIBEAM LED and DIGITAL LIGHT

Intelligent Light System function

In this system, the headlamps adapt to the driving and weather situation. It also provides extended functions for improved illumination of the road.

i The availability of the functions is dependent on the country.

The system comprises the following functions:

- Active headlamps (→ page 158)
- Cornering light (→ page 158)
- Highway mode (→ page 159)
- Enhanced fog light function (→ page 159)
- Bad weather light (→ page 159)
- City lighting (→ page 159)
- Topographical compensation (vehicles with DIGITAL LIGHT) (→ page 159)

The system is active only when it is dark.

Active headlamps function

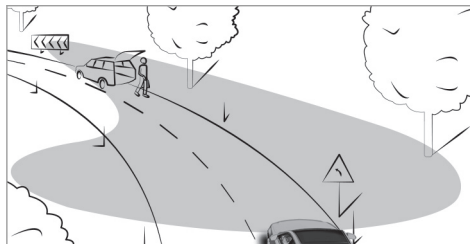

- The headlamps follow the steering movements.
- Relevant areas are better illuminated during a journey.

The functions are active when the low beam is switched on.

Depending on the vehicle's equipment, the course of the lane in which you are driving will also be evaluated and the active headlamps function will adjust the light in advance.

Cornering light function

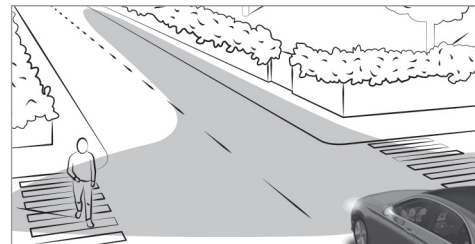

The cornering light improves the illumination of the road over a wide angle in the turning direction, enabling better visibility on tight curves, for example. It can be activated only when the low beam is switched on.

The function is active in the following cases:

- At speeds below 25 mph (40 km/h) when the turn signal light is switched on or the steering wheel is turned
- At speeds between 25 mph (40 km/h) and 43 mph (70 km/h) and when the steering wheel is turned

Roundabout and intersection function: the cornering light will be activated on both sides based on an evaluation of the vehicle's current navigation position. It will remain active until after the vehicle has left the roundabout or the intersection.

Highway mode function (Canada)

Highway mode increases the range and brightness of the cone of light, enabling better visibility.

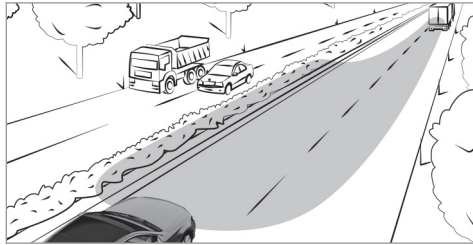

The function will be active if a highway journey is detected by means of:

- The vehicle's speed

- The multifunction camera
- The navigation system

The function is not active in the following cases:

- At speeds below 50 mph (80 km/h)

Enhanced fog light function (Canada)

The enhanced fog light function reduces self-blinding and improves the illumination of the edge of the road.

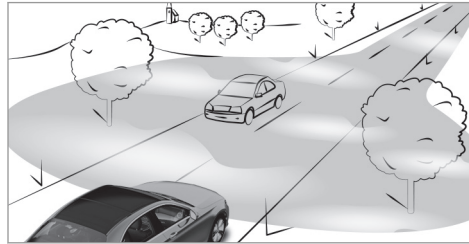

The function is automatically activated under the following conditions:

- At speeds below 43 mph (70 km/h) and when the rear fog light is switched on.

The function is automatically deactivated under the following conditions:

- When speeds greater than 62 mph (100 km/h) are reached.
- When the rear fog light is switched off.

Function of the bad weather light (Canada)

The bad weather light reduces reflections in rainy conditions by dimming individual LEDs in the headlamps. The driver and other road users are blinded less as a result.

The city lighting function (Canada)

City lighting improves the illumination of road-sides in urban areas using a broad distribution of light.

The function is active in the following cases:

- At low speeds
- In illuminated parts of urban areas

Function of the topographical compensation

Based on map data, the lighting system responds pre-emptively to different road heights. This means that the headlamp range remains vir-

tually constant when you are driving on uphill or downhill gradients.

- ① Only vehicles with a multimedia system with navigation have this function.

Assistance functions of the DIGITAL LIGHT
DIGITAL LIGHT visually expands on the driver assistance systems by projecting the assistant displays in front of the vehicle while it is in motion. DIGITAL LIGHT can therefore help the driver in critical situations.

- ① The availability of the functions is country-dependent.

The system is active in the following cases:

- The light switch is in the **AUTO** position.
- The high beam is switched on.
- ① If you activate the Head-up Display with augmented reality, the projections can be deactivated depending on the situation.
- ① Depending on the country in which you are currently driving, certain functions may be disabled due to different legal requirements, even if they are enabled in the multimedia system. When a border is crossed, the vehi-

cle will automatically adapt to the valid requirements.

Spotlight

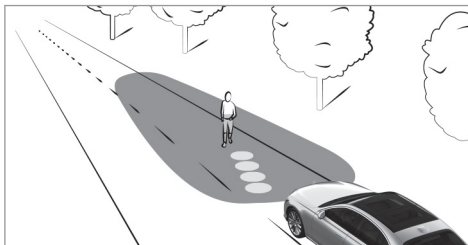

The spotlight function runs in the background and flashes the headlamps at detected persons within the lane markings in four short bursts. The driver is made aware of the position of oncoming pedestrians by a projected symbol. The function is active under the following conditions:

- You are driving outside illuminated areas.
- The system detects a lane marking.

Warnings

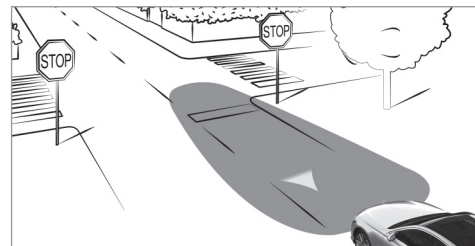

If Traffic Sign Assist detects a corresponding situation, a triangle will be projected onto the road in the following situations at speeds of at least 30 km/h:

- You are driving in the opposite direction to the permissible direction of travel, e.g. on a freeway access road.
- You are driving towards a stop sign without reducing your speed.
- You are driving towards a red traffic light without reducing your speed.

Observe the system limits of Traffic Sign Assist (→ page 244).

Notes

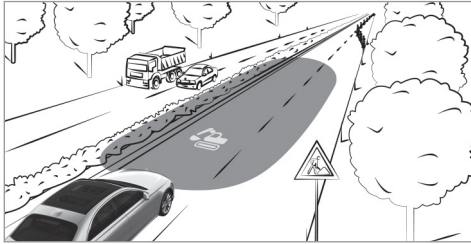

If Traffic Sign Assist detects a roadworks zone, the system will provide support as follows:

- A corresponding symbol will be projected onto the road when you enter a roadworks zone.

Observe the system limits of Traffic Sign Assist (→ page 244).

Switching the Intelligent Light System on/off

Requirements:

- The ignition is switched on.

Multimedia system:

- ➔ » Settings » Light
- ➔ MULTIBEAM LED

- ▶ Switch **Dynamic Low Beam** on or off.

- ⓘ In vehicles with DIGITAL LIGHT headlamps, the Intelligent Light System can be switched on and off on the **DIGITAL LIGHT** menu.

Activating or deactivating enhanced assistance functions

- ⓘ The availability of the functions is dependent on the country.
- ▶ Select **Supporting Projections**.
- ▶ Activate or deactivate the desired projection.
- ▶ Activate or deactivate **Projection when opening/closing**.
If the locator lighting or the exterior switch-off delay time is activated, a high-resolution greeting or farewell scene will be played back

for a short period of time when the vehicle is opened or locked.

- ⓘ More information on locator lighting (→ page 165)
More information on the exterior switch-off delay time (→ page 164)

Adaptive Highbeam Assist

Adaptive Highbeam Assist function

- ⚠ **WARNING** Risk of accident despite Adaptive Highbeam Assist

Adaptive Highbeam Assist does not react to:

- Road users without lights, e.g. pedestrians
- Road users with poor lighting, e.g. cyclists
- Road users whose lighting is obstructed, e.g. by a barrier

On very rare occasions, Adaptive Highbeam Assist may fail to recognize other road users

162 Light and visibility

with their own lighting, or may recognize them too late.

In these, or in similar situations, the automatic high beam will not be deactivated or will be activated despite the presence of other road users.

- ▶ Always observe the road and traffic conditions carefully and switch off the high beam in good time.

Adaptive Highbeam Assist cannot take into account road, weather or traffic conditions.

Detection may be restricted in the following cases:

- In poor visibility, e.g. fog, heavy rain or snow
- If there is dirt on the sensors or the sensors are obscured

Adaptive Highbeam Assist is only an aid. You are responsible for adjusting the vehicle's lighting to the prevailing light, visibility and traffic conditions.

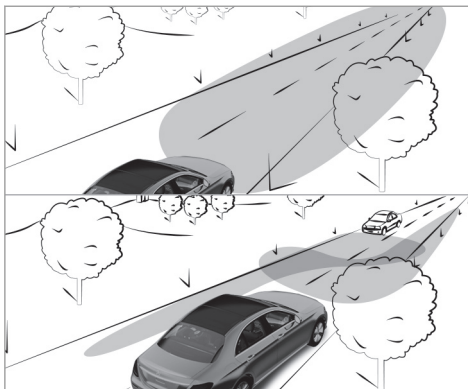

Adaptive Highbeam Assist automatically switches between the following types of light:

- Low beam
- High beam

At speeds greater than 19 mph (30 km/h):

- If no other road users are detected, the high beam will switch on automatically.

The high beam will switch off automatically in the following cases:

- At speeds below 16 mph (25 km/h)
- If other road users are detected
- If street lighting is sufficient

- ⓘ The system's optical sensor is located behind the windshield near the overhead control panel.

Switching Adaptive Highbeam Assist on/off

Switching on

- ▶ Turn the light switch to the **AUTO** position.
- ▶ Switch on the high beam using the combination switch.
If Adaptive Highbeam Assist is activated, the  indicator lamp will light up on the driver's display.

Switching off

- ▶ Switch off the high beam using the combination switch.

Adaptive Highbeam Assist Plus

Adaptive Highbeam Assist Plus function (Canada)

⚠ WARNING Risk of accident despite Adaptive Highbeam Assist Plus

Adaptive Highbeam Assist Plus does not react to:

- Road users without lights, e.g. pedestrians
- Road users with poor lighting, e.g. cyclists
- Road users whose lighting is obstructed, e.g. by a barrier

On very rare occasions, Adaptive Highbeam Assist Plus may fail to recognize other road users with their own lighting, or may recognize them too late.

In these, or in similar situations, the automatic high beam will not be deactivated or will be activated despite the presence of other road users.

- ▶ Always observe the road and traffic conditions carefully and switch off the high beam in good time.

Adaptive Highbeam Assist Plus cannot take into account road, weather or traffic conditions.

Detection may be restricted in the following cases:

- In poor visibility, e.g. fog, heavy rain or snow
- If there is dirt on the sensors or the sensors are obscured

Adaptive Highbeam Assist Plus is only an aid. You are responsible for adjusting the vehicle's lighting to the prevailing light, visibility and traffic conditions.

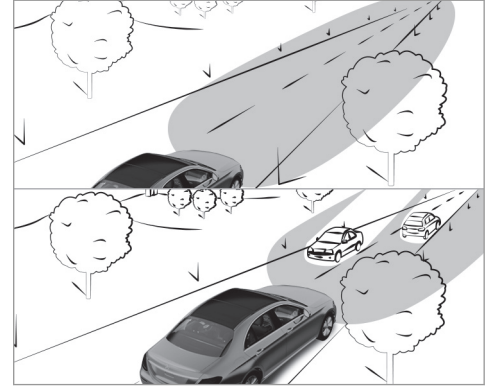

Adaptive Highbeam Assist Plus automatically switches between the following types of light:

- Low beam
- Partial high beam
- High beam
- ULTRA RANGE Highbeam (only vehicles with DIGITAL LIGHT)

ULTRA RANGE Highbeam increases the brightness of the cone of light to the legally permitted maximum.

Partial high beam does not include other road users in the high beam area. It does not blind them but enables full high beam illumination for the driver apart from the excluded vehicles.

At speeds below 16 mph (25 km/h) or when there is sufficient street lighting:

- The partial high beam and the high beam will be switched off automatically.

At speeds greater than 19 mph (30 km/h):

- If no other road users are detected, the high beam will switch on automatically.
- If other road users are detected, the partial high beam will switch on automatically.

At speeds above 25 mph (40 km/h):

- If no other road users are detected on a straight road, ULTRA RANGE Highbeam will be switched on automatically.
- If other road users are detected, the partial high beam will switch on automatically.

- If highly reflective signs are detected, ULTRA RANGE Highbeam will be switched off automatically.

- ① The system's optical sensor is located behind the windshield near the overhead control panel.

Switching Adaptive Highbeam Assist Plus on/off (Canada)

Switching on

- ▶ Turn the light switch to the **AUTO** position.
- ▶ Switch on the high beam using the combination switch. When the high beam is switched on automatically in the dark, the  indicator lamp will light up on the driver's display.

Switching off

- ▶ Switch off the high beam using the combination switch.

Switching the daytime running lamps on/off

Multimedia system:

  **Settings**  **Light**
MULTIBEAM LED

- ▶ Switch the **Daytime Running Lamps** on/off.

- ① In vehicles with DIGITAL LIGHT headlamps, the Intelligent Light System can be switched on and off in the **DIGITAL LIGHT** menu.

Setting the exterior lighting switch-off delay time

Requirements:

- The light switch is in the **AUTO** position.

Multimedia system:

  **Settings**  **Light**
Interior/exterior lighting
External Lighting Delay

- ▶ Set the switch-off delay time. When the vehicle's engine is switched off, the exterior lighting will be activated for the set time.

Activating/deactivating the locator lighting

Requirements:

- The light switch is in the **AUTO** position.

Multimedia system:

-  » Settings » Light
- » Interior/Exterior Lighting



- ▶ Activate or deactivate **Locator Lighting**.

When the function is activated, the exterior lighting will light up for 40 seconds after the vehicle is unlocked. When you start the vehicle, the locator lighting is switched off and automatic driving lights are activated.

Interior lighting

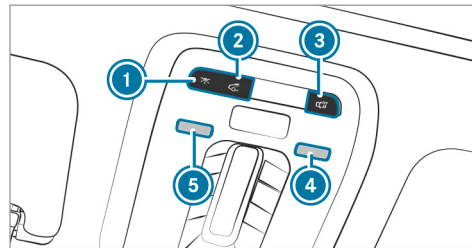
Adjusting the interior lighting





- ①  Switches the front interior lighting on/off
- ②  Switches the rear interior lighting on/off
- ③  Switches automatic interior lighting control on/off

- ▶ **To switch reading lamps on/off:** hold your hand under the respective reading lamp ④ or ⑤.

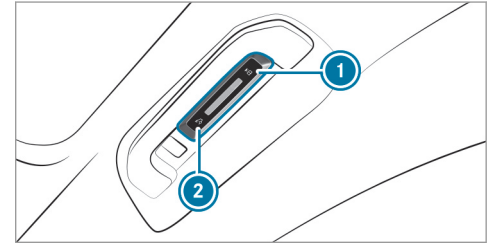
Operating unit inside the grab handle (rear passenger compartment)



- ①  Reading lamp on the respective side of the vehicle
- ②  Rear interior lighting

- ▶ **To switch reading lamps on:** press button ①. The reading lamp, the interior lighting in the grab handle and the dome lamp on the respective side of the vehicle will light up.

- ▶ **To switch reading lamps off:** press button ① once or twice.
After pressing it once, the interior lighting in the grab handle and the dome lamp on the respective side of the vehicle will go out.
After pressing it twice, the reading lamp on the respective side of the vehicle will go out.
- ▶ **To switch the rear interior lighting on/off:** press button ②.
The reading lamps, the interior lighting in the grab handle and the dome lamps on both sides of the vehicle will light up or go out.

Adjusting the ambient lighting

Multimedia system:

-  ▶ Settings ▶ Comfort
- ▶ Ambient Lighting

Setting the color

- ▶ Select **Color**.
- ▶ Select **Monochrome** or **Multi-color**.
- ▶ Set the desired color or color combination.

Adjusting the brightness

- ▶ Select **Brightness**.
- ▶ Adjust the brightness.
- ① Depending on the ambient light conditions, the ambient lighting will automatically switch between day and night modes.

Activating the brightness for zones

- ▶ Select **Brightness**.
- ▶ Switch off **Link Zones** .
The **Direct**, **Indirect** and **Accent** zones can be set separately.
- ① The **Light Band** zone can also be set for vehicles with active ambient lighting.

Activating effects

⚠ WARNING Risk of an accident despite activated effects of ambient lighting and active ambient lighting

To use the Warning Assistance effects, the respective functions must be activated in the driver assist menu.

- ▶ Make sure that the functions and assists are switched on.

- ① Observe the notes on driving systems and your responsibility; you may otherwise fail to recognize dangers (→ page 218).
- ▶ Select **Effects**.
- ▶ Activate the desired effect.
- ① Depending on the vehicle equipment, different effects are available.

Operating feedback effects

- **Climate:** If changes are made to the temperature setting in the vehicle, the color of the ambient lighting will change briefly.
- **Voice Assistant:** For vehicles with active ambient lighting, the voice assistant is visually animated.

Warning assistance effects

- **Warning When Exiting:** If an object is detected in the blind spot while you are getting out of the vehicle, the ambient lighting in the affected door will flash red.

Further information on the exit warning (→ page 250).

- **Active Lane Keeping Assist:** If there is a warning from Active Lane Keeping Assist, the active ambient lighting will flash red.

Further information on Active Lane Keeping Assist (→ page 254).

- **Active Brake Assist:** If there is an Active Brake Assist warning, the active ambient lighting in the center of the dashboard will flash bright red.

Further information on the Active Brake Assist (→ page 239).

- **Active Blind Spot Assist:** In vehicles with active ambient lighting, the ambient lighting on the affected side will flash red if there is a warning from Active Blind Spot Assist.

Further information on the Active Blind Spot Assist (→ page 250).

Greeting



- When you get into the vehicle, a special color animation will play.

Multi-color Animation

- The chosen color combination will change at predefined intervals.
- ① In vehicles with active ambient lighting, an animation will be played.
- ① The desired operating feedback and warning assistance can be activated or deactivated via the  symbol. Depending on the equipment, different operating feedback and warning assistance effects are available.
- ① If the brightness is set to a low level, warning animations will be displayed at a higher basic brightness.

Switching the interior lighting switch-off delay time on/off

Multimedia system:

  **» Settings » Light**
» Interior/exterior lighting
» Interior Lighting Delay

- ▶ Switch **Interior Lighting Delay** on or off. When this function is active, the interior lighting will light up for a short time after the vehicle is locked.

Windshield wiper and windshield washer system

Switching the windshield wipers on/off

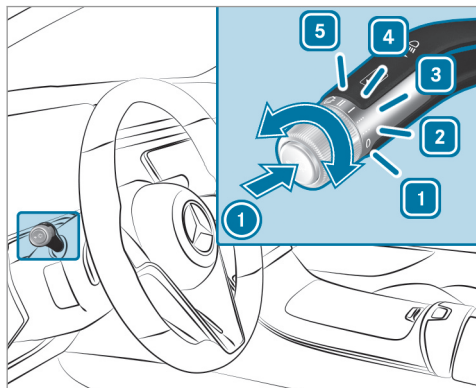

- 1** **0** Windshield wipers off
- 2** **...** Automatic wiping, normal
- 3** **...** Automatic wiping, frequent

- 4** **—** Continuous wiping, slow
- 5** **==** Continuous wiping, fast

- ▶ Turn the combination switch to the corresponding position **1** - **5**.
- ▶ **Single wipe/washing:** push the button on the combination switch in the direction of arrow **1**.
 - Single wipe
 - Wiping with washer fluid
- ⓘ Observe the notes on washing the vehicle in a car wash (→ page 343).

Vehicles with MAGIC VISION CONTROL: in position **2** or **3**, the windshield washing process is automatically triggered if dirt is detected on the windshield unless the **Check Washer Fluid** message is being displayed.

Cleaning the windshield intensively

For heavy soiling, you can clean the windshield intensively from an outside temperature of 41°F (5°C).

- ▶ In a stationary vehicle, turn the combination switch to position **1**, **2** or **3**.

- ▶ Press the button on the combination switch in the direction of arrow **1** and hold it for approximately two seconds. The wiper arms will move into the replacement position and washer fluid will be distributed on the windshield. After approximately 30 seconds, the wiper arms will move back again and wipe the windshield several times. Intensive cleaning has now finished.

Replacing the windshield wiper blades

⚠ WARNING Risk of becoming trapped if the windshield wipers are switched on while wiper blades are being replaced

If the windshield wipers begin to move while you are changing the wiper blades, you can be trapped by the wiper arm.

- ▶ Always switch off the windshield wipers and the ignition before changing the wiper blades.

Moving the wiper arms into the replacement position

- ▶ Switch the ignition on and then off again immediately.
- ▶ Within around 15 seconds, press and hold the  button on the combination switch for approximately three seconds (→ page 168). The wiper arms will move into the replacement position.

Removing the wiper blades

- ▶ Fold the wiper arms away from the wind-shield.

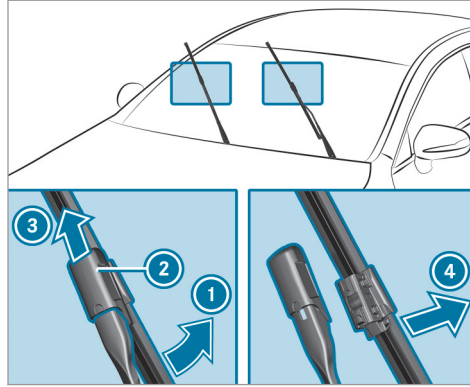

- ▶ Hold the wiper arm with one hand. With the other hand, turn the wiper blade away from the wiper arm in the direction of arrow ① as far as it will go.
- ▶ Slide catch ② in the direction of arrow ③ until it engages in the removal position.
- ▶ Remove the wiper blade from the wiper arm in the direction of arrow ④.

Installing the wiper blades

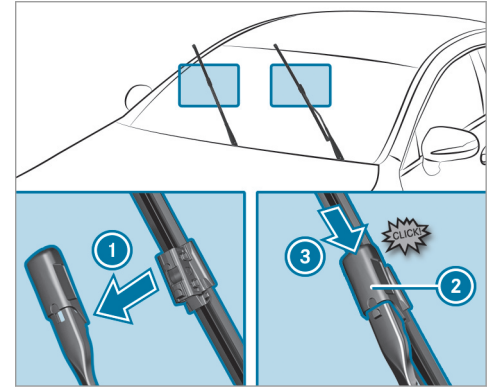

- ▶ Insert the new wiper blade into the wiper arm in the direction of arrow ①.
- ▶ Slide catch ② in the direction of arrow ③ until it engages in the locking position.
- ▶ Make sure that the wiper blade is seated correctly.

- ▶ Fold the wiper arms back onto the windshield.
 - ▶ Switch on the ignition.
 - ▶ Press the  button on the combination switch. The wiper arms will return to the original position.
 - ▶ Switch the ignition off.
- i** Check the condition of the wiper blades regularly and replace them if there is visible damage or continual smearing.

Maintenance display

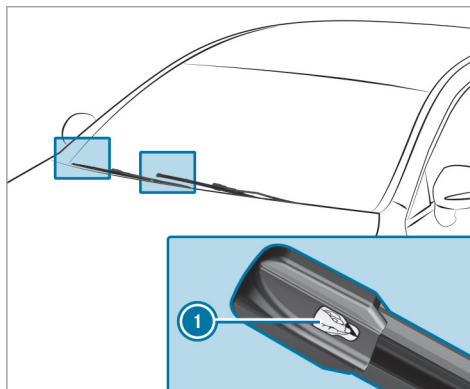

- ▶ Remove protective film **1** from the maintenance display on the tip of the newly installed wiper blades.

When the color of the maintenance display changes from black to yellow, the wiper blades should be replaced.

- i** The duration until the color changes varies depending on the usage conditions.

Replacing the windshield wiper blades (MAGIC VISION CONTROL)

Moving the wiper arms into the replacement position

- ▶ Switch the ignition off.
- ▶ Within around 15 seconds, press the  button on the combination switch (→ page 168). The wiper arms will move into the replacement position.

Removing the wiper blades

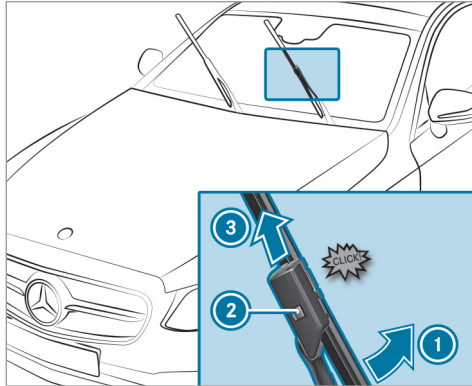

- ▶ **To bring the wiper blade into position to be removed:** hold the wiper arm firmly with one hand. With the other hand, turn the wiper blade in the direction of arrow ① beyond the point of resistance. The wiper blade will engage in the removal position with a click.

- ▶ **To remove the wiper blade:** press release knob ②, pull the wiper blade in the direction of arrow ③ and remove.

Installing the wiper blades

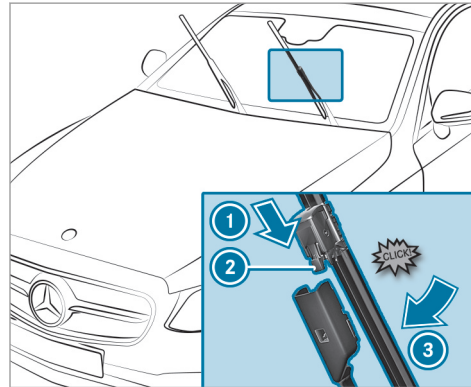

- ▶ Push the new wiper blade onto the wiper arm in the direction of arrow ① until release knob ② engages.

- ▶ Press the wiper blade onto the wiper arm in the direction of arrow ③ beyond the point of resistance. The wiper blade will engage with a noticeable click and move freely again.
- ▶ Fold the wiper arm back onto the windshield.
- ⓘ Check the condition of the wiper blades regularly and replace them in the event of visible damage or ongoing smearing.

Mirrors

Operating the outside mirrors

- ⚠ **WARNING** Risk of accident due to adjusting the vehicle settings while the vehicle is in motion

You could lose control of the vehicle in the following situations in particular:

- If you adjust the driver's seat, the head restraint, the steering wheel or the mirror while the vehicle is in motion

- If you fasten your seat belt while the vehicle is in motion
- ▶ Before starting the engine: In particular, adjust the driver's seat, head restraint, steering wheel and mirror, and fasten your seat belt.

⚠ WARNING Risk of accident due to misjudgment of distance when using the front-passenger mirror

The outside mirror on the front passenger side reflects objects on a smaller scale. The objects in view are in fact closer than they appear.

- ▶ Therefore, always look over your shoulder to check the actual distance between you and the road users traveling behind you.

Adjusting the outside mirrors

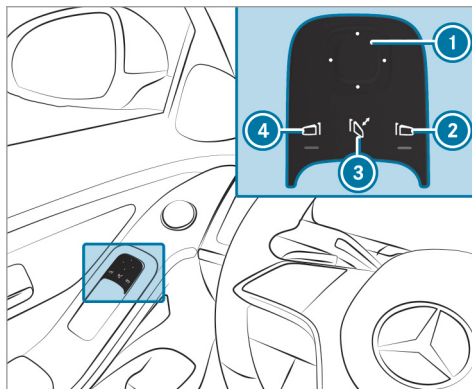

- ▶ Use button ② or ④ to select the desired mirror.
- ⓘ In vehicles with MBUX Interior Assistant and driver camera, the required outside mirror can also be preselected automatically via a natural head movement to the left or right (→ page 296).

- ▶ Use button ① to adjust the position of the selected mirror.

Folding the outside mirrors in/out

- ▶ Briefly press button ③.
- ⓘ If the battery has been disconnected or has discharged, the outside mirrors must be moved briefly using button ③. Only then will the automatic mirror folding function work properly.

Engaging the outside mirrors

If an outside mirror has been forcibly disengaged, proceed as follows.

- ▶ Press and hold button ③. You will hear a click and the mirror will audibly engage. The outside mirror will now be set to the correct position.

Automatic anti-glare mirrors function

⚠ WARNING Risk of acid burns and poisoning due to the anti-glare mirror electrolyte

Electrolyte may escape if the glass in an automatic anti-glare mirror breaks.

The electrolyte is hazardous to health and causes irritation. It must not come into contact with your skin, eyes, respiratory organs or clothing or be swallowed.

- ▶ If you come into contact with electrolyte, observe the following:
 - Immediately rinse the electrolyte from your skin with water and seek medical attention.
 - If electrolyte comes into contact with your eyes, immediately rinse them thoroughly with clean water and seek medical attention.
 - If the electrolyte is swallowed, immediately rinse your mouth out thoroughly. Do not induce vomiting. Seek medical attention immediately.

- Immediately change out of clothing which has been contaminated with electrolyte.
- If an allergic reaction occurs, seek medical attention immediately.

The inside rearview mirror and the outside mirror on the driver's side will automatically go into anti-glare mode if light from a headlamp hits the sensor on the inside rearview mirror.

System limits

The system will not go into anti-glare mode if:

- The engine is switched off.
- Reverse gear is engaged.
- The interior lighting is switched on.

Front-passenger outside mirror parking position function

The parking position makes parking easier.

The front-passenger outside mirror will swivel downwards in the direction of the rear wheel on the front passenger's side when:

- The parking position is stored (→ page 174).
- The front-passenger mirror is selected.
- Reverse gear is engaged.

The front-passenger outside mirror will move back to its original position when:

- You shift the transmission to another transmission position.
- You are traveling at a speed greater than 9 mph (15 km/h).
- You press the button for the outside mirror on the driver's side.

Storing the parking position of the front-passenger outside mirror using reverse gear

Storing

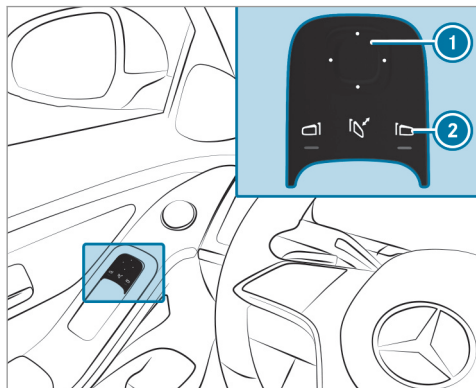

- ▶ Select the front-passenger outside mirror using button ②.
- ▶ Engage reverse gear.
- ▶ Move the front-passenger outside mirror into the desired parking position using button ①.

Calling up

- ▶ Select the front-passenger outside mirror using button ②.
- ▶ Engage reverse gear.
The front-passenger outside mirror will move into the stored parking position.

Activating/deactivating the automatic mirror folding function

Multimedia system:

- ▶  ▶ Settings ▶ Vehicle
- ▶ ▶ Opening/closing
- ▶ Switch Automatic Mirror Folding on or off.

Area permeable to radio waves on the windshield

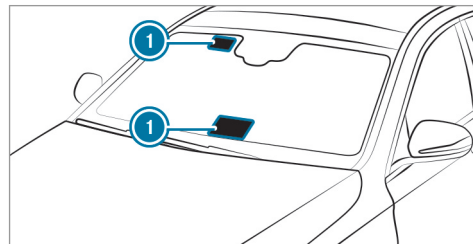

Radio-controlled equipment, such as toll systems, can be mounted only on areas ① of the windshield that are permeable to radio waves.

Areas permeable to radio waves ① are best visible from outside the vehicle when the windshield is illuminated with an external light source.

Note this position for vehicles with:

- Windshield heating
- Infrared reflective windshield

Infrared-reflective windshield function

The infrared-reflective windshield is coated and reduces the build-up of heat in the vehicle interior.

The coating shields the vehicle interior from radio waves.

Overview of climate control systems

Notes on climate control

An interior air filter in combination with the pre-filter in the engine compartment must always be used so that the air conditioning system, pollution level monitoring and the air filtration work correctly. Use filters recommended and approved by Mercedes-Benz. Always have maintenance work carried out at a qualified specialist workshop.

Overview of the 3-zone automatic climate control climate bar

The indicator lamps indicate that the corresponding function is activated.

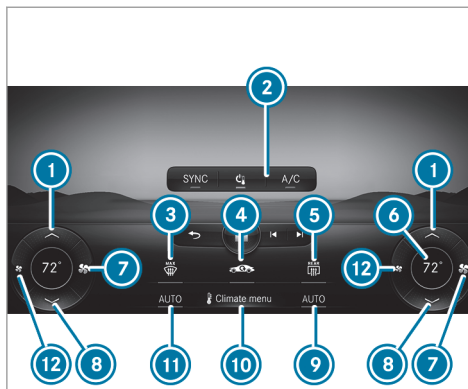









Front climate bar on the central display (example)

- ① ▲ Increases the temperature

- ② Upper display area of the climate bar with



the examples of switching off the climate control (→ page 178),  switching the A/C function on/off (→ page 179) and  synchronization function (→ page 180)

- ③  Defrosts the windshield
- ④  Switches the A/C function on/off (→ page 179)
-  Calls up the particulate status display (→ page 178)
- ⑤  Switches the rear window heater on/off
- ⑥ Depending on vehicle equipment and settings: temperature display, defrost function display, airflow, pre-entry climate control or auxiliary heating
- ⑦  Increases the airflow or switches on climate control (→ page 178)
- ⑧ ▼ Reduces the temperature
- ⑩  Calls up the air conditioning menu (→ page 178)

- ⑪ **AUTO** Sets climate control to automatic mode, left (→ page 179)
- ⑫  Reduces the airflow or switches off climate control (→ page 178)
- i The climate bar is visible even when the vehicle is parked or the air conditioning is switched off (→ page 178).
- i Vehicles with Distance Assist DISTRONIC: if Distance Assist DISTRONIC intervenes, the climate bar display on the central display is reduced.

Overview of the rear operating unit

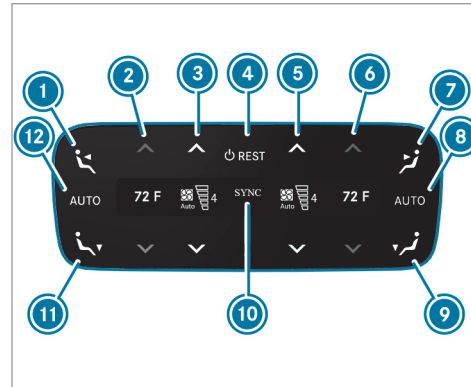

Example: USA

- ① Sets air distribution to the center and side air vents in the rear passenger compartment, left
- ② Sets the temperature in the rear passenger compartment, left
- ③ Sets the airflow in the rear passenger compartment, left, or switches climate control on/off (→ page 178)
- ④ Switches climate control on/off (→ page 178)
Switches residual heat on/off (→ page 181)
- ⑤ Sets the airflow in the rear passenger compartment, right, or switches climate control on/off (→ page 178)
- ⑥ Sets the temperature in the rear passenger compartment, right
- ⑦ Sets air distribution to the center and side air vents in the rear passenger compartment, right
- ⑧ Sets rear passenger compartment climate control to automatic mode, right
- ⑨ Sets the air distribution to the right rear passenger compartment footwell vents
- ⑩ Synchronization is activated (→ page 180)
- ⑪ Sets the air distribution to the rear passenger compartment left footwell vents
- ⑫ Sets rear passenger compartment climate control to automatic mode, left

The settings for the second row of seats can be configured via the rear operating unit, the multimedia system (→ page 180) or the MBUX rear tablet depending on the vehicle's equipment.

Operating the climate control system

Switching climate control on/off

Switching on climate control

▶ Set the airflow to level 1 or higher via  on the climate bar on the central display
or

▶ Press **AUTO**, ,  or .

Switching off climate control

▶ Set the airflow to level 0 via  on the climate bar on the central display
or

▶ Press .

If climate control is switched off, the windows may fog up more quickly. Switch climate control off only briefly.

 If the climate control is switched off via



the  button, **OFF** will be shown on the climate bar.

Switching climate control on/off via the rear operating unit

Switching on

▶ Press button .

or

▶ Set the airflow to level 1 or higher using buttons  and .



or



▶ Press button , ,  or .

Switching off

▶ Press button .

or

▶ Set the airflow to level 0 using buttons  and .

 If rear climate control is switched off via button , **OFF** will be shown on the rear display.

Switching the A/C function on/off using the air conditioning control panel

The A/C function heats, cools and dehumidifies the vehicle's interior air.

▶ Press the  button.

Switch off the A/C function only briefly; otherwise, the windows may fog up more quickly.

Condensation may drip from the underside of the vehicle when cooling mode is active. This is not indicative of a malfunction.

Calling up the air conditioning menu

The air conditioning menu can be called up via the air conditioning line. The air conditioning line is always shown on the lower edge of the central display.



- ▶ Select the **Climate Menu** entry in the air conditioning line.
The **First Row of Seats** menu is opened.

Jumping directly to the Air Quality menu

- ▶ Select the particulate status display.
The **Air Quality** menu is opened. An animation of the automatic air cleaning taking place is shown.
- ⓘ The particulate status display is on the home screen next to the temperature display on the right and it informs you of the current particulate levels inside and outside of the vehicle.
The measurement values are shown with the $\mu\text{g}/\text{m}^3$ units (micrograms per cubic meter).

Strong acceleration after longer parking periods will lead to a detachment of the dust covering the vehicle. This dust measured by the PM2.5 sensor might lead to a short rise of outside values.

Defrosting the windshield

- ▶ **To activate:** press  on the climate bar on the central display.
- ▶ **To deactivate:** press , **AUTO** or  on the climate bar of the central display
- or
- ▶ Set the airflow to 0.
- ⓘ When the defrost function is activated, some functions, such as the temperature setting, are automatically deactivated.

Activating/deactivating the A/C function via the multimedia system

Multimedia system:



↪ **Climate Menu** ▶ **First Row of Seats**

Depending on the external conditions, improved cooling and dehumidification of the interior air are supported when the A/C function is activated.

- ▶ Select **A/C (A/C)**.

Setting climate control to automatic



In automatic mode, the set vehicle interior temperature is controlled automatically and maintained at a constant level by the air supply.

- ▶ Press **AUTO** on the climate bar on the central display.
- ⓘ You can increase or reduce the airflow by pressing  on the climate bar on the central display.
- ▶ **To switch to manual operation:** switch off automatic mode or adjust an aspect of air distribution, e.g. .



Setting the air distribution

Multimedia system:

↪ **Climate Menu**



- ▶ Select **First Row of Seats** or **Second Row of Seats**.
- ▶ To set the air distribution: select ,  or .
- ▶ Set the airflow.

-  Several air distribution options can be selected at the same time, for example to set the climate control for the windshield and the footwells simultaneously. However, at least one zone is always active. When the air conditioning system is switched off, the buttons remain operable and the last setting is automatically saved.

The  climate control for the windshield can only be selected for the first seat row.
-  When the automatic mode is activated, the buttons for adjusting the air distribution are automatically disabled.

Setting the footwell temperature

Multimedia system:



-  [Climate Menu](#)
-  Select  and set the desired footwell temperature using the slider.

Setting the rear climate control





Multimedia system:

-  [Climate Menu](#)





Setting the temperature

-  Select [Second Row of Seats](#).
-  Set the temperature.

Setting the airflow

-  Select [Second Row of Seats](#).
-  Set the air flow with  or .

Controlling the rear climate control automatically

-  Select [AUTO](#).
-  When the defrost function is activated, some functions, such as the temperature setting, are automatically deactivated. To deactivate the defrost function, either press , [AUTO](#) or  or set the air volume to level 0 (→ page 179).

Deactivating rear climate control

-  Select [REAR OFF](#).

Activating/deactivating the climate control synchronization function via the multimedia system

Multimedia system:



-  [Climate Menu](#)

Climate control can be set centrally using the synchronization function. The driver's settings for temperature, airflow and air distribution will be adopted automatically for all climate zones.

-  Select [First Row of Seats](#).
-  Select [SYNC \(SYNC\)](#).

Defrosting the windows

Windows fogged up on the inside

-  Press [AUTO](#) on the climate bar of the central display.
-  If the windows remain fogged up: press  on the climate bar of the central display.

Windows fogged up on the outside

-  Switch on the windshield wipers.

- ▶ Press **AUTO** on the climate bar on the central display.

Switching air-recirculation mode on/off

Multimedia system:

↳ Climate Menu ▶▶ First Row of Seats

- ▶ Press .

The interior air will be recirculated.

Air-recirculation mode will automatically switch to fresh air mode after a while.

- ⓘ If air-recirculation mode is switched on, the windows may fog up more quickly. Switch on air-recirculation mode only briefly.

Switching residual heat on/off

Requirements:

- The residual heat function is available.
- The vehicle is parked.
- The coolant temperature is sufficiently high.

It is possible to make use of the residual heat from the engine to continue heating or ventilating the front compartment of the vehicle for approximately 30 minutes, depending on the temperature set.

- ▶ **To switch on:** select **Residual Heat** on the climate bar on the central display.

Residual heat will be switched off automatically.

- ⓘ If residual engine heat utilization is activated, the two buttons for setting the temperature and air distribution are automatically deactivated.

Switching residual heat on/off via the rear operating unit

Requirements:

- The residual heat function is available.
- The vehicle is parked.
- The coolant temperature must be sufficiently high.

When the residual heat of the engine is activated in the rear passenger compartment, you can

heat or ventilate the front and rear passenger compartments for approximately 15 minutes.

- ▶ Press the **REST** button.

Activating/deactivating ionization

Multimedia system:

↳ Climate Menu ▶▶ Air Quality

Ionization improves the quality of the vehicle's interior air. Ionization of the interior air is odorless.

- ▶ Select **Ionization**.

- ⓘ The function can only be performed if the AUTO mode is activated or the air distribution is set to the side air vent. The function is restricted if the side air vents on the driver's side are closed.

Fragrance system

Setting the fragrance system

Requirements:

- A flacon is inserted.

- The glove box is closed.
- Climate control is activated.

Multimedia system:

→ [Climate Menu](#) → [Air Quality](#)

The fragrance system distributes a pleasant fragrance throughout the vehicle interior from a flacon located in the glove box.

- ▶ Select [Fragrance](#).
- ▶ Keep pressing until the desired intensity is reached.

Inserting or removing the flacon of the fragrance system

⚠ WARNING Risk of injury from liquid perfume

If children open the flacon, they could drink the liquid perfume or it could come into contact with their eyes.

- ▶ Do not leave children unattended in the vehicle.

- ▶ Consult a doctor immediately if liquid perfume has been drunk.
- ▶ If liquid perfume comes into contact with your eyes or skin, rinse your eyes with clean water.
- ▶ If symptoms continue, consult a doctor.



ENVIRONMENTAL NOTE Environmental damage due to improper disposal of full flacons



Full flacons must not be disposed of with household waste.



Full flacons must be taken to a harmful substance collection point.

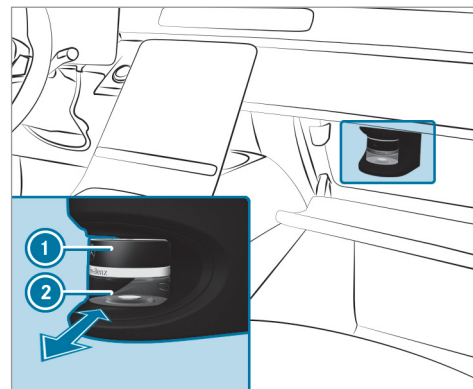

- 1 Cap
- 2 Flacon

- ▶ **To insert:** slide the flacon into the holder as far as it will go.
- ▶ **To remove:** after opening the glove box, wait for approximately seven seconds and pull out the flacon.

If you do not use genuine Mercedes-Benz interior perfumes, observe the manufacturers' safety notices on the perfume packaging.

Dispose of the genuine Mercedes-Benz interior perfume flacon when it is empty and do not refill it.

Refillable flacon

- ▶ Unscrew the cap of the empty flacon.
- ▶ Fill the flacon with a maximum of 0.5 fl. oz. (15 ml).
- ▶ Screw the cap back on to the flacon.

Always refill the empty refillable flacon with the same perfume. Observe the separate information sheet with the flacon.

Information on the windshield heater

⚠ WARNING Risk of burns from touching the windshield when the windshield heater is switched on

The windshield can become very hot when the windshield heater is switched on.

The health of persons with limited temperature sensitivity or a limited ability to react to high temperatures may be affected or they may even suffer burn-like injuries.

- ▶ Do not touch the windshield while the windshield heater is switched on.
- ▶ Allow the windshield to cool down before touching it.

The windshield heater will be enabled automatically if  is activated on the climate bar on the central display.

After the vehicle is started, the windshield heater is switched on automatically as required.

Pre-entry climate control for departure time

Pre-entry climate control for departure time function

⚠ WARNING Danger to life due to exposure to extreme heat or cold in the vehicle

If people, particularly children, are exposed to extreme temperatures over an extended period of time, there is a risk of serious injury or danger to life.

- ▶ Never leave persons, children in particular, unattended in the vehicle.

⚠ WARNING Risk of burns due to repeatedly switching on the seat heating

Repeatedly switching on the seat heating can cause the seat cushion and seat backrest padding to become very hot.

In particular, the health of persons with limited temperature sensitivity or a limited ability to react to high temperatures may be affected or they may even suffer burn-like injuries.

- ▶ Do not repeatedly switch on the seat heating.

To protect against overheating, the seat heating may be temporarily deactivated after it is switched on repeatedly.

- ⓘ This function is available only in vehicles with a 48 V on-board electrical system (EQ Boost technology).

The air inside the vehicle can be heated, ventilated or cooled to the set temperature when the vehicle is parked.

When the vehicle is connected to power supply equipment, priority is given to charging the 48 V battery to a specified minimum charge.

The running time of pre-entry climate control may be reduced under the following conditions:

- The vehicle is not connected to power supply equipment.
- The 48 V battery is not fully charged.

With active pre-entry climate control, the charge level of the 48 V battery may be reduced, even if the charging cable connector is connected.

If present, seat ventilation is activated in cooling and ventilation mode.

Depending on the vehicle's equipment, the following functions are activated in heating mode, if available:

- Seat heating
- Steering wheel heater
- Panel heating
- Mirror heater
- Rear window heater
- Windshield heater

When the set temperature is changed, climate control mode will automatically be updated and switched from heating mode to ventilation or cooling mode, from cooling mode to ventilation or heating mode or from ventilation mode to heating or cooling mode.

Setting pre-entry climate control for departure time

Multimedia system:

- ▶ Climate Menu ▶ Pre-entry Climate Ctrl.

Setting the departure time

- ▶ Select **Edit Departure Time**  .
- ▶ Select a departure time or set a new departure time.

Setting the repeat days

- ▶ Select **Edit Departure Time**  .
- ▶ Set the desired departure time and select the corresponding weekdays on which this departure time is to apply.
- ▶ Press **OK** to confirm.

Selecting seats

- ▶ Select **Driver, Passenger, Rear Left** or **Rear Right**.
Pre-entry climate control will take place for the selected seats.

Activating/deactivating pre-entry climate control for departure time

Requirements:

- The 48 V battery is charged sufficiently.
- The function has been activated via the multimedia system.

▶ **To activate:** set the departure time (→ page 184).

Pre-entry climate control for departure time switches on a maximum of 55 minutes before the selected departure time. It will remain active for another five minutes if the departure is delayed.

▶ **To deactivate the pre-entry climate control for departure time early:** press the  button or switch off the preselection of the time in the climate menu.

If present, the following functions will remain active once the vehicle has been started:

- Seat heating
- Seat ventilation
- Panel heating

Depending on the vehicle's equipment, the following functions will also be adjusted during pre-entry climate control if they have already been switched on during regular vehicle operation:

- Fragrancing
- Ionization

Activating/deactivating immediate pre-entry climate control

⚠ WARNING Danger to life due to exposure to extreme heat or cold in the vehicle

If people, particularly children, are exposed to extreme temperatures over an extended period of time, there is a risk of serious injury or danger to life.

- ▶ Never leave persons, children in particular, unattended in the vehicle.

⚠ WARNING Risk of burns due to repeatedly switching on the seat heating

Repeatedly switching on the seat heating can cause the seat cushion and seat backrest padding to become very hot.

In particular, the health of persons with limited temperature sensitivity or a limited ability to react to high temperatures may be affected or they may even suffer burn-like injuries.

- ▶ Do not repeatedly switch on the seat heating.

To protect against overheating, the seat heating may be temporarily deactivated after it is switched on repeatedly.

i Immediate pre-entry climate control is available only in vehicles with a 48 V on-board electrical system (EQ Boost technology).

Air conditioning of the vehicle interior can continue for up to 50 minutes, e.g. if the journey is interrupted.

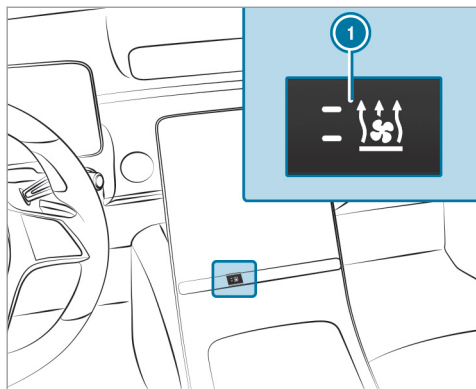

- ▶ Press button ①.
The red or blue indicator lamp on button ① will light up or go out.
- ▶ Set the temperature using the ▼▲ arrows on the climate bar on the central display.

The colors of the indicator lamp have the following meanings:

- **Blue:** Ventilation or cooling mode is switched on.

- **Red:** Heating mode is switched on.
- **Yellow:** the departure time is preselected.

Air vents

Adjusting the front air vents

⚠ WARNING Risk of burns and frostbite due to being too close to the air vents

Very hot or very cold air can flow from the air vents.

- ▶ Make sure that all vehicle occupants always maintain a sufficient distance from the air vents.
- ▶ If necessary, direct the airflow to another area of the vehicle interior.

To guarantee the flow of fresh air through the air vents into the vehicle interior, comply with the following:

- Always keep the vents and ventilation grilles in the vehicle interior clear.
- Keep the air inlet grille free of residue build-up (→ page 343).

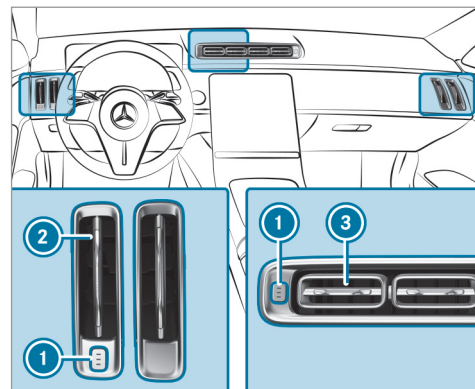

- ▶ **To open the center and side air vents:** press button ①.
The three indicator lamps on the button will light up. The air vents will be opened completely.

- ▶ **To close the center and side air vents:** press button ❶ again. The three indicator lamps on the button will go out one by one. The air vents will be closed completely.
- ▶ **To adjust the airflow direction of the side air vents:** hold outer side air vent ❷ in the center and move it up or down or to the left or right.
- ▶ **To adjust the airflow direction of the center air vent:** hold air vent ❸ in the center and move it up or down or to the left or right.

Adjusting the rear air vents

⚠ WARNING Risk of burns and frostbite due to being too close to the air vents

Very hot or very cold air can flow from the air vents.

- ▶ Make sure that all vehicle occupants always maintain a sufficient distance from the air vents.
- ▶ If necessary, direct the airflow to another area of the vehicle interior.

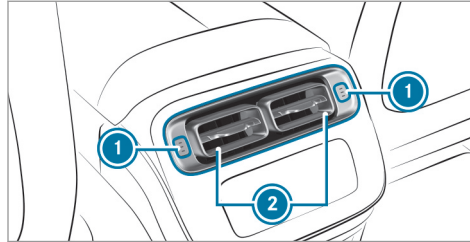

- ▶ **To open the rear air vents in the center console:** press button ❶. The air vents will be opened completely and the three indicator lamps on the button will light up.
- ▶ **To close the rear air vents in the center console:** press button ❶ again. The three indicator lamps on the button will go out one by one. The air vents will be closed completely.
- ▶ **To adjust the airflow direction of the rear air vents in the center console:** hold air vent ❷ in the center and move it up or down or to the left or right.

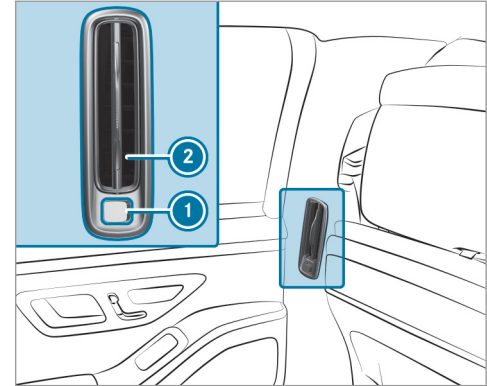

- ▶ **To open the side air vents in the rear passenger compartment:** press button ❶. If the button is flush with the side trim, the side air vent is open.
- ▶ **To close the side air vents in the rear passenger compartment:** press button ❶ again. If the button protrudes from the side trim, the side air vent is closed.

- ▶ **To adjust the airflow direction of the side air vents in the rear passenger compartment:** hold air vent ② in the center and move it up or down or to the left or right.

Opening or closing the air vent in the glove box

NOTE Damage to temperature-sensitive objects in the glove box

Temperature-sensitive objects stored in the glove box may be damaged by the air vent located inside it.

- ▶ Close the air vent when you heat the vehicle.
- ▶ At high outside temperatures, open the air vent and switch on the A/C function.

The automatic climate control must be switched on to cool the glove box.

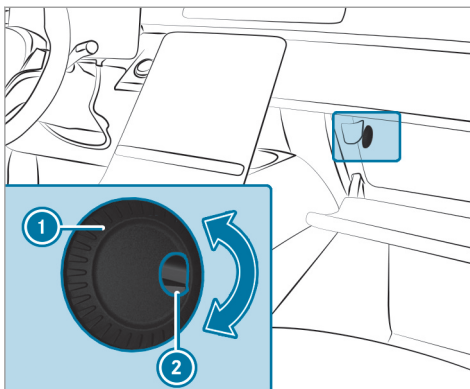

- ① Air vent controller
- ② Air vent

- ▶ **To open or close:** turn controller ① to the right or left.

Driving

Switching on the power supply or ignition

⚠ WARNING Risk of accident and injury due to children left unattended in the vehicle

If children are left unsupervised in the vehicle, they could, in particular:

- open doors, thereby endangering other persons or road users.
- get out and be struck by oncoming traffic.
- operate vehicle equipment and become trapped, for example.

In addition, the children could also set the vehicle in motion, for example by:

- releasing the parking brake.
- changing the transmission position.
- starting the vehicle.

▶ Never leave children unattended in the vehicle.

- ▶ When leaving the vehicle, always take the SmartKey with you and lock the vehicle.
- ▶ Keep the vehicle SmartKey out of reach of children.

Requirements:

- The SmartKey is in the vehicle and is recognized.
- The brake pedal is not depressed.

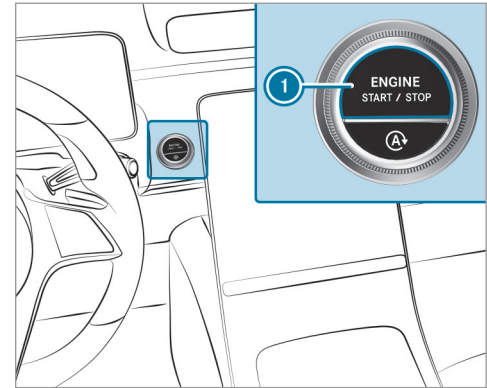

▶ **To switch on the power supply:** press button ① once. You can, for example, activate the windshield wipers.

The power supply is switched off again if the following conditions are met:

- You open the driver's door.
- You press button ① twice more.

- ▶ **To switch on the ignition:** press button ❶ twice. Indicator and warning lamps go on in the driver display.

The ignition is switched off again if one of the following conditions is met:

- You do not start the vehicle within 15 minutes and the transmission is in position **P** or the electric parking brake is applied.
- You press button ❶ once.

Starting the vehicle

Starting the vehicle with the start/stop button

⚠ DANGER Risk of death caused by exhaust gases

Combustion engines emit poisonous exhaust gases such as carbon monoxide. Inhaling these exhaust gases is hazardous to health and leads to poisoning.

- ▶ Never leave the engine or, if present, the auxiliary heating running in an enclosed space without sufficient ventilation.

⚠ WARNING Risk of fire due to flammable material in the engine compartment or the exhaust system

Flammable materials may ignite.

- ▶ Therefore, check regularly that there are no flammable materials in the engine compartment or on the exhaust system.

Requirements:

- The SmartKey is in the vehicle and is recognized.
- ▶ Shift the transmission to position **P** or **N**.
- ▶ Depress the brake pedal and press button ❶ once.
- ▶ If the vehicle does not start: Switch off non-essential consumers and press button ❶ once.

- ▶ If the vehicle still does not start and the display message **Place the Key in the Marked Space** See *Operator's Manual* also appears in the driver display: Start the vehicle with the SmartKey in the marked space (emergency operation mode) (→ page 190).

- ❶ You can switch off the engine while driving. By pressing button ❶ for about three seconds or by pressing button ❶ three times within three seconds. Be sure to observe the safety notes under "Driving tips" (→ page 194).

Observe the information regarding display messages that can be displayed on the driver display.

Starting the vehicle with the SmartKey in the marked space (emergency operation mode)

If the vehicle does not start and the **Place the Key in the Marked Space** See *Operator's Manual* display message appears in the driver display, you can start the vehicle in emergency operation mode.

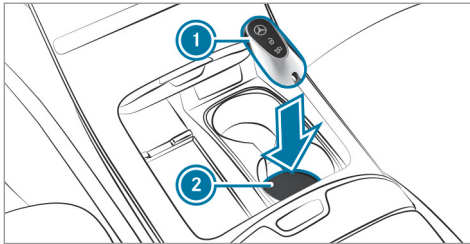

- ▶ Make sure that cup holder ② is empty.
- ▶ Remove SmartKey ① from the key ring.
- ▶ Place SmartKey ① in cup holder ②. The vehicle will start after a short time.

If SmartKey ① is removed from cup holder ②, the engine continues running. For further engine starts, however, SmartKey ① must be located in cup holder ② during the entire journey.

- ▶ Have SmartKey ① checked at a qualified specialist workshop.

If the vehicle does not start:

- ▶ Leave SmartKey ① in cup holder ②.

- ▶ Depress the brake pedal and start the vehicle using the start/stop button.

- ① You can also switch on the power supply or the ignition with the start/stop button.

Observe the information regarding display messages that can be displayed on the driver display.

Starting the vehicle via Remote Online Services

Cooling or heating the vehicle interior before starting the journey

Ensure the following before starting the engine:

- the legal stipulations in the area where your vehicle is parked allow engine starting via smartphone.
- it is safe to start and run the engine where your vehicle is parked.
- the fuel tank is sufficiently full.
- the starter battery is sufficiently charged.

Charging the starter battery before starting the journey

If the vehicle battery is discharged, you can receive a message on your smartphone. You can then start the vehicle with the smartphone to charge the battery. The vehicle is automatically switched off after ten minutes.

Ensure the following before starting the engine:

- The legal stipulations in the area where your vehicle is parked allow engine starting via smartphone.
- It is safe to start and run the engine where your vehicle is parked.
- The fuel tank is sufficiently full.

Starting the vehicle (Remote Online)

⚠ WARNING Risk of crushing or entrapment due to unintentional starting of the engine

Limbs could be crushed or trapped if the engine is started unintentionally during service or maintenance work.



- ▶ Always secure the engine against unintentional starting before carrying out maintenance or repair work.

Requirements:

- Park position **P** is selected.
- The anti-theft alarm system is not activated.
- The panic alarm is not activated.
- The hazard warning light system is switched off.
- The hood is closed.
- The doors are closed and locked.
- The windows and sliding sunroof are closed.
- ▶ Start the vehicle using the smartphone. After every engine start, the engine runs for ten minutes.

You can carry out a maximum of two consecutive starting attempts. You must start the engine with the SmartKey before trying to start the engine again with the smartphone.

You can switch off the engine at any time as follows:

- Via the smartphone app
- By pressing the  or  button on the SmartKey
- ◻ Further information can be found in the smartphone app.

Securing the engine against starting before carrying out maintenance or repair work:

- ▶ Switch on the hazard warning light system.
- or
- ▶ Unlock the doors.
- or
- ▶ Open a side window or the sliding sunroof.

Breaking-in notes

To preserve the engine during the first 1,000 miles (1,500 km):

- Drive at varying road speeds and engine speeds.

- Do not drive at speeds greater than 85 mph (140 km/h).
- Drive the vehicle in drive program **C** or **E**.
- Shift to the next highest gear at the very latest when the needle reaches the last third before the red area in the tachometer.
- Do not shift down manually in order to brake.
- Avoid overstraining the vehicle, e.g. driving at full throttle.
- Do not depress the accelerator pedal past the pressure point (kickdown).
- Only increase the engine speed gradually and accelerate the vehicle to full speed after 1,000 miles (1,500 km).

This also applies when the engine or parts of the drivetrain have been replaced.

Please also observe the following breaking-in notes:

- In certain driving and driving safety systems, the sensors adjust automatically while a certain distance is being driven after the vehicle has been delivered or after repairs. Full sys-

tem effectiveness is not reached until the end of this teach-in process.

- Brakepads, brake discs and tires that are either new or have been replaced only achieve optimum braking effect and grip after several hundred kilometers of driving. Compensate for the reduced braking effect by applying greater force to the brake pedal.

Notes on optimized acceleration

If all necessary requirements and activation conditions are fulfilled, the best possible acceleration can be achieved from a standstill.

Do not use the optimized acceleration on public roads. Individual wheels could spin and you could lose control of the vehicle. There is an increased risk of skidding and/or accident.

Be sure to observe the safety notes and information on ESP® (→ page 221).

Pulling away with optimized acceleration

⚠ WARNING Risk of skidding and having an accident from wheels spinning

When you use optimized acceleration, individual wheels could spin and you could lose control of the vehicle.

If ESP® is deactivated, there is a risk of skidding and accident.

- ▶ Make sure that no persons or obstacles are in the close vicinity of your vehicle.

Requirements:

- The vehicle has been broken in (→ page 192).
- The vehicle and tires are in good condition.
- You are on a high-grip roadway.
- The engine and transmission are at normal operating temperature.

! **NOTE** Increased wear due to optimized acceleration

When pulling away with optimized acceleration, all components of the drivetrain are subjected to a very high load.

This can lead to increased component wear.

- ▶ Do not always pull away with optimized acceleration.

- ▶ Engage the **D** drive position (→ page 205).
- ▶ Move the steering wheel to the straight-ahead position.
- ▶ Select the sportiest available drive program **S!** or **S** (→ page 202).
- ▶ Deactivate ESP® (→ page 222).
- ▶ Depress and hold the brake pedal firmly with your left foot.
- ▶ With your right foot, fully depress the accelerator pedal.

- ▶ After no more than five seconds, take your left foot quickly off the brake, but keep the accelerator pedal depressed. The vehicle pulls away at maximum acceleration.
- ▶ Switch on ESP® once the acceleration procedure is complete.

Ending optimized acceleration

- ▶ Remove your foot from the accelerator pedal.
- ▶ Reactivate the ESP®.
- ⓘ After you pull away with optimized acceleration, components of the drivetrain can become very hot, which means that optimized acceleration values may be reached again only after a few minutes.

Notes on driving

⚠ WARNING Risk of accident due to objects in the driver's footwell

Objects in the driver's footwell may impede pedal travel or block a depressed pedal.

This jeopardizes the operating and road safety of the vehicle.

- ▶ Stow all objects in the vehicle securely so that they cannot get into the driver's footwell.
- ▶ Always install the floor mats securely and as prescribed in order to ensure that there is always sufficient room for the pedals.
- ▶ Do not use loose floor mats and do not place floor mats on top of one another.

⚠ WARNING Risk of accident due to incorrect footwear

Incorrect footwear includes, for example:

- Shoes with platform soles
- Shoes with high heels
- Slippers

There is a risk of an accident.

- ▶ Always wear suitable footwear so that you can operate the pedals safely.

⚠ WARNING Risk of accident if the ignition is switched off while driving

If you switch off the ignition while driving, safety functions are restricted or no longer available.

This may affect the power steering system and the brake force boosting, for example.

You will need to use considerably more force to steer and brake, for example.

- ▶ Do not switch off the ignition while driving.

⚠ DANGER Risk of death caused by exhaust gases

Combustion engines emit poisonous exhaust gases such as carbon monoxide. Inhaling these exhaust gases is hazardous to health and leads to poisoning.

- ▶ Never leave the engine or, if present, the auxiliary heating running in an enclosed space without sufficient ventilation.

- ▲ WARNING** Risk of skidding and of an accident due to shifting down on slippery road surfaces

If you shift down on slippery road surfaces to increase the engine braking effect, the drive wheels may lose traction.

- ▶ Do not shift down on slippery road surfaces to increase the engine braking effect.

- ▲ DANGER** Risk of fatal injury due to poisonous exhaust gases

If the tailpipe is blocked or sufficient ventilation is not possible, poisonous exhaust gases such as carbon monoxide may enter the vehicle. This is the case when the vehicle becomes stuck in snow, for example.

- ▶ Keep the tailpipe and the area around the vehicle free from snow when the engine or the stationary heater are running.

- ▶ Open a window on the side of the vehicle facing away from the wind to ensure an adequate supply of fresh air.

- ▲ WARNING** Risk of accident and injury due to being under the influence of alcohol and drugs while driving

Drinking and driving and/or taking drugs and driving are very dangerous combinations. Even a small amount of alcohol or drugs can affect your reflexes, perceptions and judgment.

The possibility of a serious or even fatal accident are greatly increased when you drink or take drugs and drive.

- ▶ Do not drink or take drugs and drive or allow anyone to drive who has been drinking or taking drugs.

- ▲ WARNING** Risk of accident due to the brake system overheating

If you leave your foot on the brake pedal when driving, the brake system may overheat.

This increases the braking distance and the brake system may even cause the brake system failure.

- ▶ Never use the brake pedal as a footrest.
- ▶ Do not depress the brake pedal and the accelerator pedal at the same time while driving.

- ! NOTE** Engine damage due to excessively high engine speeds

The engine will be damaged if you drive with the engine in the overrevving range.

- ▶ Do not drive with the engine in the overrevving range.

! **NOTE** Wearing out the brake linings by continuously depressing the brake pedal

- ▶ Do not depress the brake pedal continuously whilst driving.
- ▶ To use the braking effect of the engine, shift to a lower gear in good time.

! **NOTE** Damage to the drivetrain and engine when pulling away

- ▶ Do not warm up the engine while the vehicle is stationary. Pull away immediately.
- ▶ Avoid high engine speeds and driving at full throttle until the engine has reached its operating temperature.

! **NOTE** Damage to the catalytic converter due to non-combusted fuel

The engine is not running smoothly and is misfiring.
Non-combusted fuel may get into the catalytic converter.

▶ Only depress the accelerator pedal slightly.

▶ Have the cause rectified immediately at a qualified specialist workshop.

! **NOTE** Reduced battery life due to frequent short-distance trips

The 12 V battery may not be sufficiently charged when the vehicle is used only for short-distance trips. This reduces the life of the battery.

▶ Drive longer distances regularly to charge the battery.

Notes on driving with a roof load, trailer or fully laden vehicle

When driving with a loaded roof luggage rack or trailer as well as with a fully laden or fully occupied vehicle, the vehicle's driving and steering characteristics change.

You should bear the following in mind:

- Do not exceed the permissible roof load and towing capacity. Also observe the technical data in the printed Operator's Manual.
- Evenly distribute the roof load, and place heavy objects at the bottom. Also comply with the notes on loading the vehicle (→ page 134).
- Drive attentively, and avoid suddenly pulling away, braking and steering as well as rapid cornering.

Notes on driving on salt-treated roads

The braking effect is limited on salt-treated roads.

Therefore, observe the following notes:

- due to salt build-up on the brake discs and brakepads, the braking distance can increase considerably or result in braking only on one side
- maintain a much greater safe distance to the vehicle in front

To remove salt build-up:

- brake occasionally while paying attention to the traffic conditions
- carefully depress the brake pedal at the end of the journey and when starting the next journey

Notes on hydroplaning

Hydroplaning can take place once a certain amount of water has accumulated on the road surface.

Observe the following notes during heavy precipitation or in conditions in which hydroplaning may occur:

- Reduce speed
- Avoid tire ruts
- Avoid sudden steering movements
- Brake carefully

i Also observe the notes on regularly checking wheels and tires (→ page 373).

Notes on driving through water on the road surface

Water which has entered into the vehicle can damage the engine, electrics and transmission.

Water can also enter the air intake of the engine and cause engine damage.

Observe the following if you must drive through water:

- The water, when calm, may only reach the lower edge of the vehicle body.
- Drive at a maximum speed of 6 mph (10 km/h); water can otherwise enter the vehicle interior or engine compartment.
- Vehicles traveling in front, or oncoming vehicles, can create waves which may exceed the maximum permissible depth of the water.

The braking effect of the brakes is reduced after fording. Brake carefully while paying attention to the traffic conditions until braking power has been fully restored.

Function of rear axle steering

The rear axle steering is an electromechanical auxiliary steering on the rear axle which adjusts the steering of the rear wheels according to the position of the front wheels, depending on the speed. This results in greater maneuverability and improved driving stability, e.g. when cornering.

Rear axle steering has the following characteristics:

- Reduced steering effort and turning radius resulting in reduced parking effort
- Improved driving stability, e.g. when cornering
- More direct steering resulting in improved handling of the vehicle

Observe the notes on snow chains and snow chain mode (→ page 374).

ECO start/stop function

ECO start/stop function

- ① Depending on the engine, the ECO start/stop function is not available in all drive programs. Observe the status display in the driver display for this.

The engine is switched off automatically in the following situations if all vehicle conditions for an automatic engine stop are met:

- You brake the vehicle to a standstill in transmission position **D** or **N**.
- **Vehicles with a 48 V on-board electrical system:** You depress the brake pedal when traveling at a low speed.

If the system has detected one of the following situations, the engine will not stop:





- You stop at a stop sign and there is no vehicle in front of you.
- The vehicle that stopped in front of you starts up again.
- You maneuver, turn the steering wheel sharply or engage reverse gear.

- ① If the system detects an intelligent stop inhibitor, for example, a stop sign, the engine will not stop.
If you activate the HOLD function or engage the park position **P**, the engine can be switched off in spite of an intelligent stop inhibitor.

The engine is restarted automatically if:

- You engage transmission position **D** or **R**.
- You depress the accelerator pedal.
- An automatic engine start is required by the vehicle.
- You release the brake pedal.
- **Vehicles with a 48 V on-board electrical system:**
 - You release the brake pedal on a downhill gradient and the vehicle does not roll.
 - The vehicle rolls on a downhill gradient and does not automatically enter glide mode at 15 mph (20 km/h).

ECO start/stop function symbols in the driver display:

- The  symbol (green) appears when the vehicle is at a standstill: The engine was switched off by the ECO start/stop function.
- The  symbol (yellow) appears when the vehicle is at a standstill: Not all vehicle conditions for an engine stop have been met.
- Neither the  nor  symbol appears when the vehicle is at a standstill: An intelligent stop inhibitor was detected, for example, a stop sign.
- The  symbol appears: The ECO start/stop function is deactivated or there is a malfunction.

If the engine was switched off by the ECO start/stop function and you leave the vehicle, a warning tone sounds and the engine is not restarted. In addition, the following display message appears in the driver display:

Vehicle Ready to Drive Switch the Ignition Off Before Exiting

If you do not switch off the ignition, it is automatically switched off after three minutes.

Deactivating or activating the ECO start/stop function

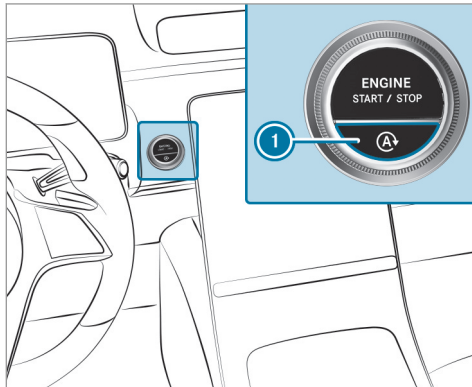

- ▶ Press button ①.
A display appears in the driver display when switching the ECO start/stop function off/on.

- ① A continuous  display appears in the driver display while the ECO start/stop function is deactivated.

ECO display function

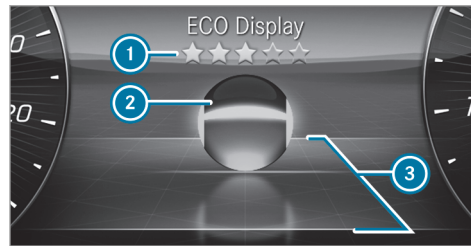

The ECO display shows an evaluation of your driving style on the driver display depending on the situation. This enables you to check the efficiency of your driving style and adjust it if necessary. The **ECO Display** menu shows a ball ② that will roll forwards or backwards on a stylized road in the direction of travel according to the driving characteristics.

Above and below the road, lines mark the area for an efficient driving style ③. Ball ② will light up in green if it is rolling within these lines. Outside the lines, the ball will light up in orange.

The ECO display assesses the following criteria for an economical driving style:

- Coasting at the right time
- Consistent speed
- Moderate acceleration

The overall assessment of your driving style "from start" is indicated with stars. It starts with five empty stars, which you can fill one after the other if you drive efficiently. When all five stars are filled, a glow appears in the background.

- ① You can call up the **ECO Display** function via the **Classic** and **Exclusive** menus (→ page 281).

ECO Assist function (vehicles with 48 V on-board electrical system)

- ① ECO Assist is active only in drive programs  and .

200 Driving and parking

ECO Assist analyzes data for the vehicle's expected route. This allows the system to optimally adjust the driving style for the route ahead, save fuel and recuperate. If the system detects an event ahead and the vehicle nears the event, ECO Assist will calculate the optimum speed for maximum fuel economy and recuperative energy based on the distance, speed and downhill gradient.



ECO Assist display on the driver's display on the Assistance menu

- ① "Foot off the accelerator" recommendation
- ② Route event ahead

If a route event that can be dealt with more efficiently by adjusting your driving style is detected ahead, corresponding symbol ② will be displayed.

In addition, the  symbol will be displayed until you take your foot off the accelerator or until you have passed the route event.

Symbol ② will disappear as soon as ECO Assist cannot identify any further recommendations from the route ahead.

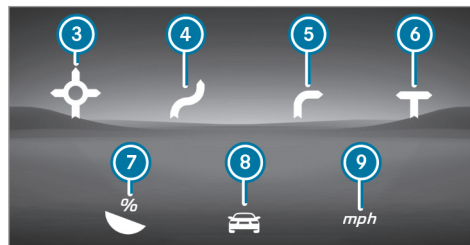

The following route events can be detected by ECO Assist:

- ③ Roundabout

- ④ S-curve
- ⑤ Sharp curve
- ⑥ T-intersection
- ⑦ Downhill gradient
- ⑧ Vehicle in front
- ⑨ Speed limit

① Only route event ⑧ "vehicle in front" will be displayed in drive program .

System limits

If the calculated route is adhered to when route guidance is active, ECO Assist will operate with greater accuracy. The basic function is also available without active route guidance. Not all information and traffic situations can be foreseen. The quality depends on the map data.

ECO Assist is only an aid. The driver is responsible for keeping a safe distance from the vehicle in front, for vehicle speed and for braking in good time.

The system may be impaired or may not function in the following situations:

- If there is poor visibility, e.g. due to insufficient illumination of the road, if there are highly variable shade conditions or in rain, snow, fog or heavy spray.
- If there is glare, e.g. from oncoming traffic, direct sunlight or reflections.
- If the windshield in the area of the multifunction camera is dirty, or if the camera is fogged up, damaged or covered.
- If the traffic signs are hard to detect, e.g. due to dirt, snow or insufficient lighting, or because they are covered.
- If the information in the navigation system's digital map is incorrect or out-of-date.
- If the signs are ambiguous, e.g. road signs in roadworks or in adjacent lanes.

DYNAMIC SELECT button

Function of the DYNAMIC SELECT button

- ① Depending on the engine and equipment, the vehicle has different drive programs.

Use the DYNAMIC SELECT button to change between the following drive programs:

The chosen drive program appears in the driver display.

I Individual

- Individual settings

S' Sport+

- Very sporty driving style with lowered suspension
- Emphasizes the vehicle's own oversteering and understeering characteristics for a more active driving style
- Only suitable for good road conditions, a dry road surface and a clear stretch of road

S Sport

- Sporty driving style with lowered suspension
- Still sporty, but with an emphasis on stability

- Allows the sporty driver a more active driving style
- Only suitable for good road conditions, a dry road surface and a clear stretch of road

C Comfort

- Comfortable and economical driving
- Balance between traction and stability
- Recommended for all road conditions

CV Curve

- Only available for vehicles with E-ACTIVE BODY CONTROL
- Comfortable driving with curve inclination function
- Balance between traction and stability
- Recommended for all road conditions

E Eco

- Particularly economical driving
- Balance between traction and stability
- Recommended for all road conditions

Depending on the drive program, the following systems change their characteristics:

- Drive
 - Engine and transmission management
 - Active Distance Assist DISTRONIC
 - Availability of Glide mode
- ESP®
- Suspension
 - Suspension and damping
 - Vehicle level
- Steering

Selecting the drive program

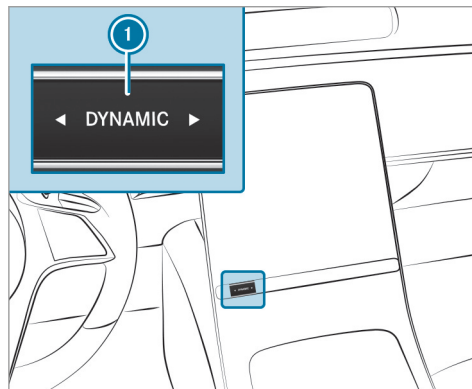

- ▶ Press DYNAMIC SELECT button ① on the left or right. The chosen drive program appears in the display of the button.

Configuring DYNAMIC SELECT (multimedia system)

Multimedia system:

- ▶ Settings ▶ Vehicle
- ▶ DYNAMIC SELECT

Setting drive program I

- ▶ Select **Individual**.
- ▶ Select and set a category.

Switching the reset display on/off

- ▶ Switch **Request at Start** on or off.

ⓘ This function must be activated for each user profile separately. Only when this function is activated will the drive program and ECO start/stop setting for the previous journey be saved for the respective user profile.

Function on: the next time the vehicle is started a prompt appears asking whether the last active drive program should be restored. If the ECO start/stop function was deactivated, an additional prompt appears asking if the function should remain deactivated.

-  The prompt appears only if the previously active settings deviate from the standard settings.

Function off: the next time the vehicle is started the  drive program is set automatically. The ECO start/stop function is activated automatically.

Displaying vehicle data

Multimedia system:

   Info

-  Select **Vehicle**.
The vehicle data is displayed.

Displaying engine data

Multimedia system:

   Info

-  Select **Engine**.
The engine data is displayed.



-  The actual (maximum) values that can be achieved for engine output and engine torque may deviate from the certified values

within the country-specific guidelines for permissible tolerances (basis: UN-ECE No. 85 or country-specific guidelines).

Influencing variables that can influence this are, for example:

- Sea level
- Fuel quality
- Outside temperature
- Operating temperature of the engine

Please adjust your driving style accordingly. The  warning lamp in the instrument cluster is on until the engine has reached operating temperature.

-  The values displayed serve only as orientation. The values for engine output and engine torque shown in the central display may deviate from the actual values.
-   to display the power reduction after engine start is not available in all vehicle models.

Calling up the fuel consumption indicator

Multimedia system:

   Info

-  Select **Consumption**.
The current and average fuel consumption is displayed.

Automatic transmission

DIRECT SELECT lever

Function of the DIRECT SELECT lever

 **WARNING** Risk of accident due to incorrect gearshifting

If the engine speed is higher than the idle speed and you engage the transmission position **D** or **R**, the vehicle may accelerate sharply.

-  If you engage the transmission position **D** or **R** when the vehicle is at a standstill, always depress the brake pedal firmly and do not accelerate at the same time.

⚠ WARNING Risk of accident and injury due to children left unattended in the vehicle

If children are left unsupervised in the vehicle, they could, in particular:

- open doors, thereby endangering other persons or road users.
- get out and be struck by oncoming traffic.
- operate vehicle equipment and become trapped, for example.

In addition, the children could also set the vehicle in motion, for example by:

- releasing the parking brake.
 - changing the transmission position.
 - starting the vehicle.
- ▶ Never leave children unattended in the vehicle.
- ▶ When leaving the vehicle, always take the SmartKey with you and lock the vehicle.

▶ Keep the vehicle SmartKey out of reach of children.

Use the DIRECT SELECT lever to switch the transmission position. The current transmission position is shown in the driver display.

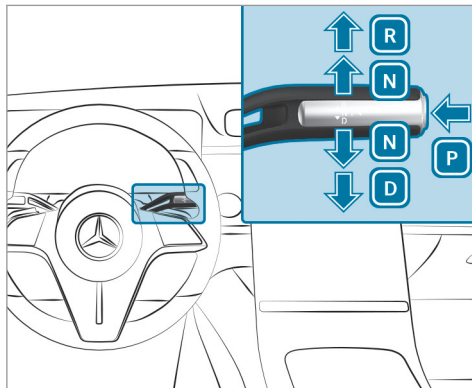

- P** Park position
R Reverse gear

- N** Neutral
D Drive position

Engaging reverse gear R

▶ Depress the brake pedal and push the DIRECT SELECT lever upwards past the first point of resistance.

Engaging neutral N

▶ Depress the brake pedal and push the DIRECT SELECT lever up or down to the first point of resistance.

i To shift into neutral **N** with the ignition on, push the selector lever up or down for several seconds to the first point of resistance.

Subsequently releasing the brake pedal will allow you to move the vehicle freely, e.g. to push it or tow it away.

Proceed as follows if you want the automatic transmission to remain in neutral **N, even if the ignition is switched off or the driver's door is opened:**

▶ Depress the brake pedal and engage neutral **N** when the vehicle is at a standstill.

- ▶ Release the brake pedal.
- ▶ Switch the ignition off.

The **Risk of Vehicle Rolling Away N Activated Manually No Automatic Change to P** message appears on the driver's display.

- ⓘ If you then exit the vehicle leaving the SmartKey in the vehicle, the automatic transmission remains in neutral **N**.

The park position **P** is automatically re-engaged as soon as one of the following conditions is met:

- You switch to transmission position **D** or **R**.
- You press the button **P**.

Engaging park position P

- ▶ Observe the notes on parking the vehicle (→ page 210).
- ▶ Depress the brake pedal until the vehicle comes to a standstill.

- ▶ When the vehicle is at a standstill, press button **P**.
When the transmission position display shows **P**, the park position is engaged. If no transmission position display **P** appears, secure the vehicle to prevent it from rolling away.

- ⓘ Depending on the situation, it may take a short time until **P** is engaged. Therefore, always pay attention to the transmission position display.

Park position **P** is engaged automatically if one of the following conditions is met:

- You switch off the ignition when the vehicle is stationary and the transmission position is **D** or **R**.
- You open the driver's door when the vehicle is at a standstill or when driving at a very low speed and the transmission position is **D** or **R**.
- You switch off the engine and bring the vehicle to a standstill when the vehicle is rolling and the transmission position is **D** or **R**.

- You switch off the engine, bring the vehicle to a standstill and open the driver's door when the vehicle is stationary or when the vehicle is rolling and the transmission position is **N**.
- Engaging park position **P** automatically is required by the vehicle.

- ⓘ To maneuver with an open driver's door, open the driver's door while at a standstill and engage transmission position **D** or **R** again.

Engaging drive position D

- ▶ Depress the brake pedal and push the DIRECT SELECT lever down past the first point of resistance.

When the automatic transmission is in transmission position **D**, it shifts the gears automatically. This depends, among other things, on the following factors:

- The selected drive program
- The position of the accelerator pedal
- The driving speed

Manual gearshifting

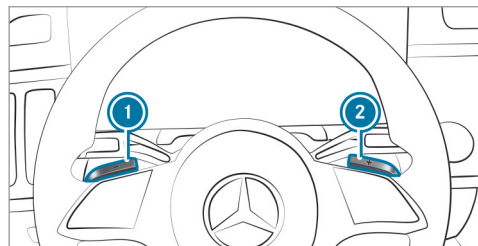

When the automatic transmission is shifted to position **D**, you can manually shift it with the steering wheel gearshift paddle. If permitted, the automatic transmission shifts to a higher or lower gear depending on the steering wheel gearshift paddle being pulled.

You have two options to manually shift the automatic transmission:

- Temporary setting
- Permanent setting

The gears shift automatically when manual shifting is deactivated.

Temporary setting:

▶ **To activate:** pull steering wheel gearshift paddle **1** or **2**. Manual shifting is activated for a short time. The transmission position display shows **M** and the current gear.

i How long the manual shifting stays activated is dependent on various factors.

Manual shifting can be automatically deactivated in the following cases:

- Changing the drive program
- Restarting the vehicle
- When the transmission position **D** is engaged again
- Driving style

▶ **To shift up:** pull steering wheel gearshift paddle **2**.

▶ **To shift down:** pull steering wheel gearshift paddle **1**.

▶ **To deactivate:** pull steering wheel gearshift paddle **2** and hold it in place. The transmission position display shows **D**.

Permanent setting:

- ▶ Change to drive program **1** (→ page 202).
- ▶ Select drive setting **M** (→ page 202).

Gearshift recommendation

The gearshift recommendation assists you in adopting an economical driving style.



- ▶ If gearshift recommendation **1** appears next to the transmission position display, shift to the recommended gear.

Using kickdown

- ▶ **Maximum acceleration:** depress the accelerator pedal beyond the pressure point.

To protect against engine overrev, the automatic transmission shifts up to the next gear when maximum engine speed has been reached.

Glide mode function

With an anticipatory driving style, Glide mode helps you to reduce fuel consumption.

Glide mode is characterized by the following:

- The combustion engine is disconnected from the drivetrain and continues to run in neutral.
- The transmission position display **D** is shown in green.
- **Vehicles with 48 V on-board electrical system (EQ Boost technology):** The combustion engine can be switched off. All of the vehicle functions remain active.

Glide mode is activated if the following conditions are met:

- Drive program **E** is selected.
 - The speed is within a suitable range.
 - The road's course is suitable, e.g. no steep uphill or downhill inclines or tight curves.
 - You do not depress the accelerator or brake pedal (except for light brake applications).
- ⓘ Glide mode can also be activated if you have selected the "Eco" setting for the drive in the drive program **TV**.

Glide mode is deactivated again if one of the conditions is no longer met.

Glide mode can also be prevented by the following parameters:

- Incline
- Downhill gradient
- Temperature
- Height
- Speed
- Operating status of the engine

- Traffic situation

Function of the 4MATIC

4MATIC ensures that all four wheels are driven. Together with ESP® and 4ETS, 4MATIC improves the traction of your vehicle whenever a driven wheel spins due to insufficient traction.

If you fail to adapt your driving style, 4MATIC can neither reduce the risk of an accident nor override the laws of physics. 4MATIC cannot take account of road, weather and traffic conditions. 4MATIC is only an aid. You are responsible especially for maintaining a safe distance from the vehicle in front, for vehicle speed, for braking in good time and for staying in lane.

- ⓘ In wintry road conditions, the maximum effect of 4MATIC can be achieved only if you use winter tires (M+S tires), with snow chains if necessary.

Refueling

Refueling the vehicle

⚠ WARNING Risk of fire or explosion from fuel

Fuels are highly flammable.

- ▶ Fire, open flames, smoking and creation of sparks must be avoided.
- ▶ Switch off the ignition and, if available, the stationary heater, before and while refueling the vehicle.

⚠ WARNING Risk of injury from fuels

Fuels are poisonous and hazardous to your health.

- ▶ Do not swallow fuel or let it come into contact with skin, eyes or clothing.
- ▶ Do not inhale fuel vapor.
- ▶ Keep children away from fuel.
- ▶ Keep doors and windows closed during the refueling process.

If you or other people come into contact with fuel, observe the following:

- ▶ Immediately rinse fuel off your skin with soap and water.
- ▶ If fuel comes into contact with your eyes, immediately rinse them thoroughly with clean water. Seek medical attention immediately.
- ▶ If you swallow fuel, seek medical attention immediately. Do not induce vomiting.
- ▶ Change immediately out of clothing that has come into contact with fuel.

⚠ WARNING Risk of fire and explosion due to electrostatic charge

Electrostatic charge can ignite fuel vapor.

- ▶ Before you open the fuel filler cap or take hold of the pump nozzle, touch the metallic vehicle body.

- ▶ To avoid creating another electrostatic charge, do not get into the vehicle again during the refueling process.

! NOTE Damage caused by the wrong fuel

Vehicles with a gasoline engine:

Even small amounts of the wrong fuel could result in damage to the fuel system, the engine and the emission control system.

- ▶ Only refuel with low-sulfur gasoline.

This fuel may contain up to 10% ethanol. Your vehicle is suitable for use with E10 fuel.

Never refuel with one of the following fuels:

- Diesel
- Gasoline with more than 10% ethanol by volume, e.g. E15, E85, E100
- Gasoline with more than 3% methanol by volume, e.g. M15, M30, M85, M100
- Gasoline with additives containing metal

If you have accidentally refueled with the wrong fuel:

- ▶ Do not switch the ignition on.
- ▶ Consult a qualified specialist workshop.

! **NOTE** Do not use diesel to refuel vehicles with a gasoline engine

If you have accidentally refueled with the wrong fuel:

- Do not switch the ignition on. Otherwise fuel can enter the engine. Even small amounts of the wrong fuel could result in damage to the fuel system and the engine. The repair costs are high.
- ▶ Consult a qualified specialist workshop.
- ▶ Have the fuel tank and fuel lines drained completely.

! **NOTE** Damage to the fuel system caused by overfilled fuel tanks

- ▶ Only fill the fuel tank until the pump nozzle switches off.

If you have added too much fuel because of a defective filling pump, for instance:

- ▶ Do not switch the ignition on.
- ▶ Consult a qualified specialist workshop.

! **NOTE** Fuel may spray out when you remove the fuel pump nozzle

- ▶ Only fill the fuel tank until the pump nozzle switches off.

Requirements:

- The vehicle is unlocked.
- i** Do not get into the vehicle again during the refueling process. Otherwise, electrostatic charge could build up again.

Observe the notes on operating fluids and fuel.

Only refuel with fuel that has at least the octane number specified in the information label in the fuel filler flap. Otherwise, engine output can be reduced and fuel consumption increased.

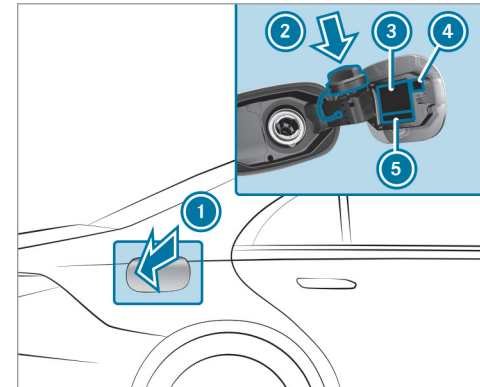

- 1** Fuel filler flap
- 2** Bracket for fuel filler cap
- 3** Tire pressure table

210 Driving and parking

④ QR code for rescue card

⑤ Fuel type

- ▶ Press on the back area of fuel filler flap ①.
- ▶ Turn the fuel filler cap counter-clockwise and remove it.
- ▶ Insert fuel filler cap from above into bracket ②.
- ▶ Completely insert the pump nozzle into the tank filler neck, hook in place and refuel.
- ▶ Only fill the fuel tank until the pump nozzle switches off.
- ▶ Replace the cap on the filler neck and turn clockwise until it engages audibly.
- ▶ Close fuel filler flap ①.

Parking

Parking the vehicle

⚠ WARNING Risk of accident and injury caused by an insufficiently secured vehicle rolling away

If the vehicle is not securely parked sufficiently, it can roll away in an uncontrolled way even at a slight downhill gradient.

- ▶ On uphill or downhill gradients, turn the front wheels so that the vehicle rolls towards the curb if it starts moving.
- ▶ Apply the parking brake.
- ▶ Switch the transmission to position **P**.

⚠ WARNING Risk of fire caused by hot exhaust system parts

Flammable materials such as leaves, grass or twigs may ignite.

- ▶ Park the vehicle so that no flammable material can come into contact with hot vehicle components.

- ▶ In particular, do not park on dry grass-land or harvested grain fields.

⚠ WARNING Risk of accident and injury due to children left unattended in the vehicle

If children are left unsupervised in the vehicle, they could, in particular:

- open doors, thereby endangering other persons or road users.
- get out and be struck by oncoming traffic.
- operate vehicle equipment and become trapped, for example.

In addition, the children could also set the vehicle in motion, for example by:

- releasing the parking brake.
 - changing the transmission position.
 - starting the vehicle.
- ▶ Never leave children unattended in the vehicle.

- ▶ When leaving the vehicle, always take the SmartKey with you and lock the vehicle.
- ▶ Keep the vehicle SmartKey out of reach of children.

! **NOTE** Damage to the vehicle due to it rolling away

- ▶ Always secure the vehicle against rolling away.

! **NOTE** Damage due to the vehicle lowering

Vehicles with AIRMATIC or E-ACTIVE BODY CONTROL: The vehicle can lower because of temperature differences or longer non-operational times. This can cause damage to parts of the body.

- ▶ When stopping the vehicle and when driving off, make sure that there are no obstacles such as curbs under or in the immediate vicinity of the body.

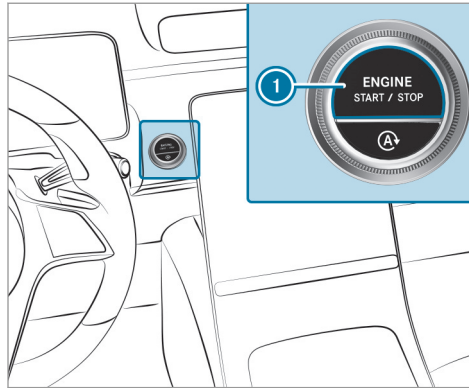

- ▶ Bring the vehicle to a standstill by pressing the brake pedal.
- ▶ On gradients, turn the front wheels so that the vehicle will roll towards the curb if it starts moving.
- ▶ Apply the electric parking brake.

- ▶ Engage transmission position **P** in a stationary vehicle with the brake pedal applied (→ page 205).
 - ▶ Switch off the engine and the ignition by pressing button **1**.
 - ▶ Release the service brake slowly.
 - ▶ Get out of the vehicle and lock it.
- i** When you park the vehicle, you can still operate the side windows and the panoramic sliding sunroof for approximately four minutes if the driver's door is closed.

Garage door opener

Programming buttons for the garage door opener

! **DANGER** Risk of death caused by exhaust gases

Combustion engines emit poisonous exhaust gases such as carbon monoxide. Inhaling these exhaust gases is hazardous to health and leads to poisoning.

- ▶ Never leave the engine or, if present, the auxiliary heating running in an enclosed space without sufficient ventilation.

⚠ WARNING Risk of injury by becoming trapped when opening and closing a garage door

When you operate or program a garage door with an integrated garage door opener, persons can become trapped or struck by the garage door if they stand within its range of movement.

- ▶ Always make sure that nobody is within the range of the garage door's movement.

Only operate the following doors using the garage door opener:

- Doors with a safety stop and reversing feature
- Doors which conform to the current U.S. safety standards

Requirements:

- The vehicle has been parked outside the garage or outside the range of movement of the door.
 - The engine is switched off.
 - The ignition is switched on.
- i** The garage door opener function is always available when the ignition is switched on.

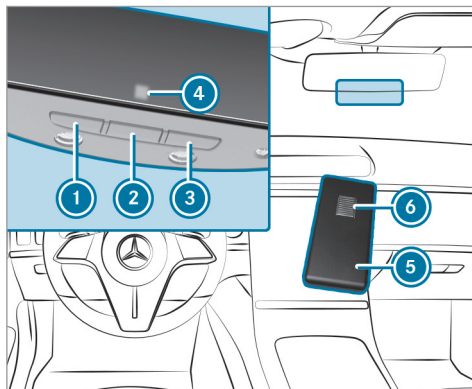

- ▶ Check if the transmitter frequency of the remote control has the frequency range of 280 to 868 MHz.

Radio equipment approval number:

- NZLMUAHL5 (USA)
- 4112A-MUAHL5 (Canada)

- ▶ Press and hold button ①, ② or ③ that you wish to program. Indicator lamp ④ flashes yellow.

i It can take up to 20 seconds before the indicator lamp flashes yellow.

- ▶ Release the previously pressed button. Indicator lamp ④ continues to flash yellow.

- ▶ Point remote control ⑤ from a distance of 0.4 in (1 cm) to 3 in (8 cm) towards button ①, ② or ③.

- ▶ Press and hold button ⑥ of remote control ⑤ until one of the following signals appears:

- Indicator lamp ④ lights up green continuously. Programming is complete.
- Indicator lamp ④ flashes green. Programming was successful. Additionally,

synchronization of the rolling code with the door system must be carried out.

- ▶ If indicator lamp ④ does not light up or flash green: repeat the procedure.
- ▶ Release all of the buttons.
- ⓘ The remote control for the door drive is not included in the scope of delivery of the garage door opener.

Synchronizing the rolling code

Requirements:

- The door system uses a rolling code.
- The vehicle must be within range of the garage door or door drive.
- The vehicle as well as persons and objects are located outside the range of movement of the door.
- ▶ Press the programming button on the door drive unit. Initiate the next step within approximately 30 seconds.

- ▶ Press previously programmed button ①, ② or ③ repeatedly until the door closes. When the door closes, programming is completed.
- ⓘ Please also read the operating instructions for the door drive.

Troubleshooting when programming the remote control

- ▶ Check if the transmitter frequency of remote control ⑤ is supported.
- ▶ Replace the batteries in remote control ⑤.

Mercedes-Benz recommends that you have the battery replaced at a qualified specialist workshop.

- ▶ Hold remote control ⑤ at various angles from a distance of 0.4 in (1 cm) to 3 in (8 cm) front of the inside rearview mirror. You should test every position for at least 25 seconds before trying another position.
- ▶ Hold remote control ⑤ at the same angles at various distances in front of the inside rearview mirror. You should test every posi-

tion for at least 25 seconds before trying another position.

- ▶ On remote controls that transmit only for a limited period, press button ⑥ on remote control ⑤ again before transmission ends.
- ▶ Angle the antenna line of the garage door opener unit towards the remote control.
- ⓘ Support and additional information on programming:
 - On the toll free HomeLink® Hotline on 1-800-355-3515
 - On the Internet at <https://www.homelink.com/mercedes>

Opening or closing the garage door

Requirements:

- The corresponding button is programmed to operate the door.
- ▶ Press and hold buttons ①, ② or ③ until the door opens or closes.
- ▶ If indicator lamp ④ flashes yellow after approximately 20 seconds: press and hold

214 Driving and parking

the previously pressed button again until the door opens or closes.

Clearing the garage door opener memory

- ▶ Press and hold buttons ① and ③. Indicator lamp ④ lights up yellow.
- ▶ If indicator lamp ④ flashes green: release buttons ① and ③. The entire memory has been deleted.

Electric parking brake

Function of the electric parking brake (applying automatically)

▲ WARNING Risk of accident and injury due to children left unattended in the vehicle

If children are left unsupervised in the vehicle, they could, in particular:

- open doors, thereby endangering other persons or road users.

- get out and be struck by oncoming traffic.
- operate vehicle equipment and become trapped, for example.

In addition, the children could also set the vehicle in motion, for example by:

- releasing the parking brake.
- changing the transmission position.
- starting the vehicle.

- ▶ Never leave children unattended in the vehicle.
- ▶ When leaving the vehicle, always take the SmartKey with you and lock the vehicle.
- ▶ Keep the vehicle SmartKey out of reach of children.

The electric parking brake is applied if the transmission is in position **P and one of the following conditions is fulfilled:**

- The engine is switched off.

- The seat belt tongue is not inserted in the seat belt buckle of the driver's seat and the driver's door is opened.

i To prevent application: pull the handle of the electric parking brake (→ page 215).

In the following situations, the electric parking brake is also applied:

- The HOLD function is keeping the vehicle stationary.
- Active Parking Assist is keeping the vehicle stationary.
- Active Distance Assist DISTRONIC is bringing the vehicle to a standstill.
- **In addition, one of the following conditions must be fulfilled:**
 - The engine is switched off.
 - The seat belt tongue is not inserted in the seat belt buckle of the driver's seat and the driver's door is opened.
 - There is a system malfunction.
 - The power supply is insufficient.

- The vehicle is stationary for a lengthy period.

When the electric parking brake is applied, the red **PARK** (USA) or **(P)** (Canada) indicator lamp lights up in the driver display.

- i** The electric parking brake is not automatically applied if the engine is switched off by the ECO start/stop function.

Function of the electric parking brake (releasing automatically)

The electric parking brake is released when the following conditions are fulfilled:

- The driver's door is closed.
- The engine is running.
- The transmission is in position **D** or **R** and you depress the accelerator pedal or you shift from transmission position **P** to **D** or **R** when on level ground.
- If the transmission is in position **R**, the trunk lid must be closed.
- The seat belt tongue is inserted into the seat belt buckle of the driver's seat.

When the electric parking brake is released, the red **PARK** (USA) or **(P)** (Canada) indicator lamp in the driver display goes out.

Applying/releasing the electric parking brake manually

Applying

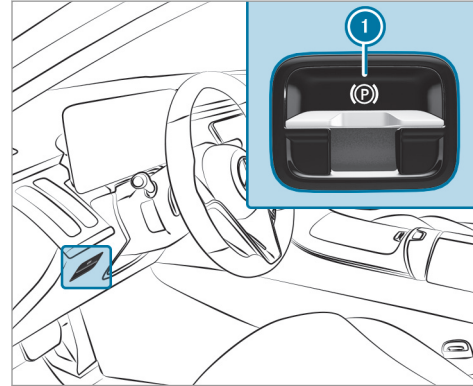

- ▶ Push handle **1**.
The red **PARK** (USA) or **(P)** (Canada) indicator lamp lights up in the driver display.

- i** The electric parking brake is only securely applied if the red **PARK** (USA) or **(P)** (Canada) indicator lamp is lit continuously.

Releasing

- ▶ Switch on the ignition.
- ▶ Pull handle **1**.
The red **PARK** (USA) or **(P)** (Canada) indicator lamp in the driver display goes out.

Emergency braking

- ▶ Press and hold handle **1**.
As long as the vehicle is driving, the **Please Release Parking Brake** message is displayed and the red **(P)** indicator lamp flashes.
When the vehicle has been braked to a standstill, the electric parking brake is applied. The red **PARK** (USA) or **(P)** (Canada) indicator lamp lights up in the driver display.

Information on collision detection on a parked vehicle

If a collision is detected when the tow-away alarm is armed on a locked vehicle, you will receive a notification in the multimedia system when you switch on the ignition.

You will receive information about the following points:

- The area of the vehicle that may have been damaged.
- The force of the impact.

The following situations can lead to inadvertent activation:

- The parked vehicle is moved, e.g. in a two-story garage.

- ① Deactivate the tow-away alarm in order to prevent inadvertent activation. If you deactivate the tow-away alarm, collision detection will also be deactivated. You can permanently deactivate collision detection via the multimedia system (→ page 216).

- ① If the battery is severely discharged, the function for detecting a collision on a parked vehicle is automatically deactivated to facilitate the next engine start.

System limits

Detection may be restricted in the following situations:

- The vehicle is damaged without impact, e.g. if an outside mirror is torn off or the paint is damaged by a SmartKey
- An impact occurs at low speed
- The electric parking brake is not applied

Setting collision detection on a parked vehicle

Multimedia system:

→  » Settings » Vehicle
» Collision Notification

- ▶ Activate or deactivate the function under **Collision detection**.
- ① A maximum of three incidents can be registered. Up to 15 photos are taken for every

incident. In the event of another incident, the photos of the first incident will be overwritten if they have not been deleted already.

Activating or deactivating the collision photos function

Please note possible legal restrictions in some countries regarding automatic recording of the vehicle surroundings.

- ▶ Activate or deactivate **Collision photos**.

Transferring the collision photos with the Mercedes me app

- ▶ Select **Upload Collision Photos**.
- ▶ Scan the QR code on the central display with the Mercedes me app. The encrypted collision photos will then be uploaded to Mercedes me.

- ① Any device that can scan QR codes can be used to view the collision photos in the Mercedes me app.

Copying the collision photos to a USB flash drive

- ▶ Connect a USB flash drive .

- ▶ Select [Manage Collision Photos](#).
- ▶ Select [Copy \(USB\)](#).
All collision photos are copied to the USB flash drive.
- ⓘ To ensure secure operation, only use FAT32 or exFAT formatted USB storage devices.

Deleting collision photos

- ▶ Select [Manage Collision Photos](#).
- ▶ Select [Delete](#).
All collision photos will be deleted.

Notes on parking the vehicle for an extended period

If you leave the vehicle parked for longer than six weeks, it may suffer damage through disuse.

The 12 V battery may also be impaired or damaged by heavy discharging.

- ⓘ Further information can be obtained at a qualified specialist workshop.

Standby mode (extension of the starter battery's period out of use)

Standby mode function

ⓘ This function is not available for all models. If standby mode is activated, energy loss will be minimized during extended periods of non-operation.

Standby mode is characterized by the following:

- The starter battery is preserved.
- The maximum non-operational time appears in the driver's display.
- The connection to online services is interrupted.

If the following conditions are fulfilled, standby mode can be activated or deactivated using the multimedia system:

- The engine is switched off.
- The ignition is switched on.

Exceeding the vehicle's displayed non-operational time may cause inconvenience; i.e. it cannot be guaranteed that the starter battery will reliably start the engine.

Charge the starter battery in the following situations:



- The vehicle's non-operational time must be extended.
- The starter battery charge level is insufficient for standby mode.
- ⓘ Standby mode is automatically deactivated when the ignition is switched on.

Activating/deactivating standby mode (parking the vehicle for an extended period)

Requirements:

- The engine is switched off.

Multimedia system:

- ▶   ▶ [Settings](#) ▶ [Vehicle](#)
- ▶ [Opening/closing](#)
- ▶ Activate or deactivate [Standby Mode](#).

Driving and driving safety systems

Driving systems and your responsibility

Your vehicle is equipped with driving systems which assist you in driving, parking and maneuvering the vehicle. The driving systems are only aids. They are not a substitute for your attention to the surroundings and do not relieve you of your responsibility pertaining to road traffic law. The driver is always responsible for maintaining a safe distance to the vehicle in front, for vehicle speed, for braking in good time and for staying in lane. Pay attention to the traffic conditions at all times and intervene when necessary. Be aware of the limitations regarding the safe use of these systems.

Driving systems can neither reduce the risk of accident if you fail to adapt your driving style nor override the laws of physics. They cannot always take into account road, weather or traffic conditions.

Information on vehicle sensors and cameras

Some driving and driving safety systems use cameras as well as radar, lidar or ultrasonic sensors to monitor the area in front of, behind or next to the vehicle.

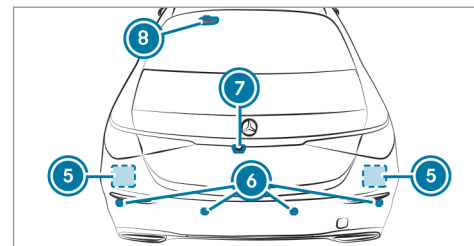
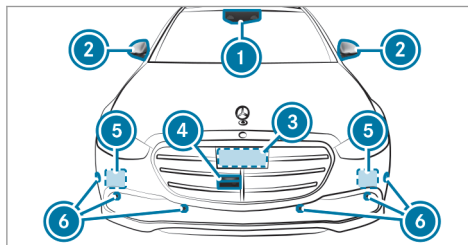

- ① Multifunction camera
- ② Cameras in the outside mirrors
- ③ Front radar
- ④ Front camera
- ⑤ Corner radars
- ⑥ Ultrasonic sensors
- ⑦ Rear view camera

▲ WARNING Risk of accident due to restricted detection performance of vehicle sensors and cameras

If the area around vehicle sensors or cameras is covered, damaged or dirty, certain driving and safety systems cannot function correctly. There is a risk of an accident.

- ▶ Keep the area around vehicle sensors or cameras clear of any obstructions and clean.
- ▶ Have damage to the bumper, radiator grille or stone chipping in the area of the front and rear windows repaired at a qualified specialist workshop.

Particularly, keep the areas around the sensors and cameras free of dirt, ice or slush (→ page 346). The sensors and cameras must not be covered and the detection ranges around them must be kept free. Do not attach additional license plate bracket, advertisements, stickers, foils or foils to protect against stone chippings in the detection range of the sensors and cameras.

Make sure that there are no overhanging loads protruding into the detection range.

If there is damage to a bumper or the radiator grille, or after an impact, have the function of the sensors checked at a qualified specialist workshop. Have damage or stone chipping in the area of the cameras on the front and rear windows repaired at a qualified specialist workshop.

i The rear view camera may move in and out automatically for the purpose of calibration, even though there is no camera image in the display.

Overview of driving systems and driving safety systems

- ABS (**A**nti-**l**ock **B**raking **S**ystem) (→ page 220)
- BAS (**B**rake **A**ssist **S**ystem) (→ page 220)
- ESP® (**E**lectronic **S**tability **P**rogram) (→ page 221)
- ESP® Crosswind Assist (→ page 222)
- EBD (**E**lectronic **B**rakeforce **D**istribution) (→ page 222)
- STEER CONTROL (→ page 222)
- HOLD function (→ page 223)
- Hill Start Assist (→ page 224)
- ATTENTION ASSIST (→ page 224)
- Traffic Sign Assist (→ page 244)
- Traffic light view (→ page 248)
- AIRMATIC (→ page 256)
- E-ACTIVE BODY CONTROL (→ page 258)

Driving Assistance package

- Active Distance Assist DISTRONIC (→ page 226)
- Active Speed Limit Assist (country-dependent) (→ page 230)
- Route-based speed adaptation (country-dependent) (→ page 231)
- Active Brake Assist (→ page 239)
- Active Steering Assist (country-dependent) (→ page 233)

220 Driving and parking

- Active Emergency Stop Assist (country-dependent) (→ page 235)
- Active Lane Change Assist (country-dependent) (→ page 237)
- Active Stop-and-Go Assist (country-dependent) (→ page 233)
- Active Blind Spot Assist with exit warning (→ page 250)
- Active Lane Keeping Assist (→ page 254)
- PRE-SAFE® Impulse Side (→ page 61)

Parking Package

- ① The availability of individual functions is country and equipment-dependent.
- Rear view camera (→ page 261)
- Surround view camera (→ page 263)
- Parking Assist PARKTRONIC (→ page 268)
- Active Parking Assist (→ page 271)

Functions of ABS (Anti-lock Braking System)

ABS regulates the brake pressure in critical driving situations:

- During braking, e.g. at maximum full-stop braking or insufficient tire traction, the wheels are prevented from locking.
- Vehicle steerability while braking is ensured.

If ABS intervenes when braking, you will feel a pulsing in the brake pedal. The pulsating brake pedal can be an indication of hazardous road conditions and can serve as a reminder to take extra care while driving.

System limits

- ABS is active from speeds of approx. 3 mph (5 km/h).
- ABS may be impaired or may not function if a malfunction has occurred and the yellow  ABS warning lamp lights up continuously in the instrument cluster after the engine is started.

Function of BAS

▲ WARNING Risk of an accident caused by a malfunction in BAS (Brake Assist System)

If BAS is malfunctioning, the braking distance in an emergency braking situation is increased.

- ▶ Depress the brake pedal with full force in emergency braking situations. ABS prevents the wheels from locking.

The Brake Assist System (BAS) supports your emergency braking situation with additional brake force.

If you depress the brake pedal quickly, BAS is activated:

- BAS automatically boosts the brake pressure.
- BAS can shorten the braking distance.
- ABS prevents the wheels from locking.

The brakes will function as usual once you release the brake pedal. BAS is deactivated.

Function of ESP® (Electronic Stability Program)

⚠ WARNING Risk of skidding if ESP® is deactivated

If you deactivate ESP®, ESP® cannot carry out vehicle stabilization.

▶ ESP® should only be deactivated in the following situations.

ESP® can monitor and improve driving stability and traction in the following situations, within physical limits:

- When pulling away on a wet or slippery road.
- When braking.

If the vehicle deviates from the direction desired by the driver, ESP® can stabilize the vehicle by intervening in the following ways:

- One or more wheels are braked.
- The engine output is adapted according to the situation.

When ESP® is deactivated, the  warning lamp lights up continuously:

- Driving stability will no longer be improved.
 - The drive wheels could spin.
 - ETS/4ETS traction control is still active.
- i** When ESP® is deactivated, you are still assisted by ESP® when braking.

When the  warning lamp flashes, one or several wheels has reached its grip limit:

- Adapt your driving style to suit the current road and weather conditions.
- Do not deactivate ESP®.
- Only depress the accelerator pedal as far as is necessary when pulling away.

Deactivate ESP® in the following situations to improve traction:

- When using snow chains.
- In deep snow.
- On sand or gravel.

i Spinning the wheels results in a cutting action, which enhances traction.

If the  ESP® warning lamp lights up continuously, ESP® is not available due to a malfunction.

Observe the following information:

- Warning and indicator lamps (→ page 561)
- Display messages (→ page 503)

ETS/4ETS (Electronic Traction System)

ETS/4ETS traction control is part of ESP® and makes it possible to pull away and accelerate on a slippery road.

ETS/4ETS can improve the vehicle's traction by intervening in the following ways:

- The drive wheels are braked individually if they spin.
- More drive torque is transferred to the wheel or wheels with traction.

Influence of drive programs on ESP®

The drive programs enable ESP® to adapt to different weather and road conditions as well as the driver's preferred driving style. Depending on the selected drive program, the appropriate

222 Driving and parking

ESP® mode will be activated. You can select the drive programs using the DYNAMIC SELECT switch (→ page 202).

Function of ESP® Crosswind Assist

ESP® Crosswind Assist detects sudden gusts of side wind and helps the driver to keep the vehicle in the lane:

- ESP® Crosswind Assist is active at vehicle speeds between approx. 47 mph (75 km/h) and 125 mph (200 km/h) when driving straight ahead or cornering slightly.
- The vehicle is stabilized by means of individual brake application on one side.

Activating/deactivating ESP® (Electronic Stability Program)

Multimedia system:



-  ESP® can only be activated/deactivated using quick access when at least one other function is available in quick access. ESP®

can otherwise be found in the Assistance menu.

- ▶ Select ESP.
- ▶ Select On or  Off.

ESP® is deactivated if the  ESP® OFF warning lamp lights up continuously in the instrument cluster.

Observe any information on warning lamps and display messages which may be shown in the instrument cluster.

Function of EBD

Electronic Breakforce Distribution (EBD) is characterized by the following:

- Monitoring and regulating the brake pressure on the rear wheels.
- Improved driving stability when braking, especially on bends.

Function of STEER CONTROL

STEER CONTROL assists you by transmitting a noticeable steering force to the steering wheel in the direction required for vehicle stabilization.

This steering recommendation is given in the following situations:

- Both right wheels or both left wheels are on a wet or slippery road surface when you brake
- The vehicle starts to skid

System limits

STEER CONTROL may be impaired or may not function in the following situations:

- ESP® is deactivated.
- ESP® is malfunctioning.
- The steering is malfunctioning.

If ESP® is malfunctioning, you will be assisted further by the electric power steering.

HOLD function

HOLD function

The HOLD function holds the vehicle at a standstill without requiring you to depress the brake pedal, e.g. while waiting in traffic.

The HOLD function is only an aid. The responsibility for the vehicle safely standing still remains with the driver.

System limits

The HOLD function is only intended to provide assistance when driving and is not a sufficient means of safeguarding the vehicle against rolling away when stationary.

- The incline must not be greater than 30%.

Activating/deactivating the HOLD function

⚠ WARNING Risk of an accident due to the HOLD function being active when you leave the vehicle

If the vehicle is only braked with the HOLD function it could, in the following situations, roll away:

- If there is a malfunction in the system or in the power supply.
- If the HOLD function is deactivated by depressing the accelerator pedal or brake pedal, e.g. by a vehicle occupant.

▶ Always secure the vehicle against rolling away before you leave it.

Requirements:

- The vehicle is stationary.
- The driver's door is closed or the seat belt on the driver's side is fastened.
- The engine is running or has been automatically switched off by the ECO start/stop function.

- The electric parking brake is released.
- Active Distance Assist DISTRONIC is deactivated.
- The transmission is in position **D**, **R** or **N**.

Activating the HOLD function

▶ Depress the brake pedal, and after a short time quickly depress further until the **HOLD** display appears in the driver display.

▶ Release the brake pedal.

Deactivating the HOLD function

▶ Depress the accelerator pedal to pull away.
or

▶ Depress the brake pedal until the **HOLD** display disappears from the driver display.

The HOLD function is deactivated in the following situations:

- Active Distance Assist DISTRONIC is activated.
- The transmission is shifted to position **P**.
- The vehicle is secured with the electric parking brake.

224 Driving and parking

In the following situations, the vehicle is held by transmission position **P** and/or by the electric parking brake:

- The seat belt is unfastened and the driver's door is opened.
- The vehicle is switched off.
- There is a system malfunction.
- The power supply is insufficient.

In addition, the **Brake Immediately** message may appear in the driver display and a horn tone may sound at regular intervals.

- ▶ Immediately depress the brake pedal firmly until the warning message disappears. The HOLD function is deactivated.
- ▶ Additionally secure the vehicle against rolling away.

Function of Hill Start Assist

Hill Start Assist holds the vehicle for a short time when pulling away on a hill under the following conditions:

- The transmission is in position **D** or **R**.

- The electric parking brake is released.

This gives you enough time to move your foot from the brake pedal to the accelerator pedal and depress it before the vehicle begins to roll away.

⚠ WARNING Risk of accident and injury due to the vehicle rolling away

After a short time, Hill Start Assist no longer holds the vehicle.

- ▶ Swiftly move your foot from the brake pedal to the accelerator pedal. Do not leave the vehicle when it is being held by Hill Start Assist.

ATTENTION ASSIST

Function of ATTENTION ASSIST with micro-sleep detection

- ① The microsleep detection subfunction is only available in combination with the driver camera.

ATTENTION ASSIST assists you on long, monotonous journeys, e.g. on highways and trunk roads. If indicators of fatigue or increasing lapses in concentration on the part of the driver are detected, the system suggests taking a break.

ATTENTION ASSIST is only an aid. It cannot always detect fatigue or lapses in concentration in time. The system is not a substitute for a well-rested and attentive driver. On long journeys, take regular breaks in good time that allow for adequate recuperation.

You can choose between two settings:

- **Standard:** normal system sensitivity.
- **Sensitive:** increased system sensitivity: the driver is warned earlier and the attention level detected by the system is adapted accordingly.

If drowsiness or increasing lapses in concentration are detected, the **ATTENTION ASSIST: Take a Break!** warning appears on the driver display. You can acknowledge the message and take a break where necessary. If you do not take a break and ATTENTION ASSIST continues to detect increasing lapses in concentration, you

will be warned again after a minimum of 15 minutes.



The following information is displayed on the driver display:

- The length of the journey since the last break
- The attention level determined by ATTENTION ASSIST:
 - More segments ② of the circle displayed, the higher the detected attention level.
 - Fewer segments ② are displayed in the circle as the attention level decreases.
- Microsleep detection ① status:
 - Deactivated: display ① is hidden.
 - Activated but not operational: display ① is gray.
 - Activated and operational: display ① is green.

If ATTENTION ASSIST is unable to calculate the attention level and cannot issue a warning, the **System Suspended** message appears.

If the system, which uses the driver camera, detects indicators of microsleep, the **ATTENTION ASSIST Nodding Off Take a Break!** warning message appears on the driver display and a warning tone sounds simultaneously. This warning message must be confirmed by Touch Control. It is recommended that you take a break immediately.

If a warning is given on the driver display, the multimedia system offers to search for a rest area. You can select a rest area and start navigation to this rest area.

ATTENTION ASSIST with microsleep detection is activated automatically when the engine is

restarted. The last selected sensitivity level remains stored.

System limits

ATTENTION ASSIST is active in the 37 mph (60 km/h) to 124 mph (200 km/h) speed range.

The microsleep detection function is available at a speed of 12.5 mph (20 km/h) and above.

Particularly in the following situations, ATTENTION ASSIST only functions in a restricted manner and warnings may be delayed or not occur:

- If you have been driving for less than approximately 30 minutes.
- If the road condition is poor (uneven road surface or potholes).
- If there is a strong side wind.
- If you adopt a sporty driving style (high cornering speeds or high rates of acceleration).
- If the Steering Assist function of Active Distance Assist DISTRONIC is active.
- If the clock is set to the incorrect time.
- If you change lanes and vary your speed frequently in active driving situations.

Microsleep detection also does not function when the driver camera cannot detect the driver's eyes, for example as a result of the following factors:

- The driver's eyes are covered due to the steering column position, for example.
- Poor ambient light.
- Some types of eyeglasses or sunglasses.
- The driver's line of vision is outside the driver camera's field of vision.

Also observe any information regarding display messages that can be displayed on the driver display.

The tiredness and alertness assessment of ATTENTION ASSIST with microsleep detection is reset and restarted when continuing the journey in the following situations:

- If you switch off the engine.
- If you unfasten your seat belt and open the driver's door (e.g. to change drivers or take a break).

Active Distance Assist DISTRONIC

Function of Active Distance Assist DISTRONIC

Active Distance Assist DISTRONIC maintains the set speed on free-flowing roads. If vehicles in front are detected, the set distance is maintained, if necessary, until the vehicle comes to a halt. The vehicle accelerates or brakes depending on the distance to the vehicle in front and the set speed. The speed and distance to the vehicle in front are set and saved using the steering wheel.

Active Distance Assist DISTRONIC is available in the 15 mph (20 km/h) to 130 mph (210 km/h) speed range.

Other features of Active Distance Assist DISTRONIC:

- Adjusts the driving style depending on the selected drive program (fuel-saving, comfortable or dynamic) (→ page 201)
- Initiates acceleration to the stored speed if the turn signal indicator is switched on to change to the overtaking lane

- Reacts to stationary vehicles detected in urban speed ranges (except bicycles and motorcycles)
- Takes one-sided overtaking restrictions into account on highways or on multi-lane roads with separate roadways (country-dependent)

Additional function available in certain countries:

if Active Distance Assist DISTRONIC has braked the vehicle to a standstill, it can automatically follow the vehicle in front when driving off again within 30 seconds. If a critical situation is detected in the surrounding area when driving off, such as a person in the vehicle path, a visual and acoustic warning is given indicating that the driver must now take control of the vehicle. The vehicle is not accelerated any further.

Active Distance Assist DISTRONIC is ready to pull away when the green  vehicle symbol flashes cyclically.

Observe the notes on driving systems and your responsibility; you may otherwise fail to recognize dangers (→ page 218).

Driver display in the Assistance menu

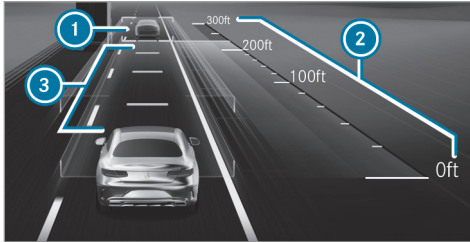

- ① Vehicle in front
- ② Distance indicator
- ③ Set specified distance

Vehicle detected in front ① is highlighted in green. It may also be in the lane to the left of your vehicle in situations where it is not permitted to overtake on the right, for example on highways.

Permanent status display



-  (white): Active Distance Assist DISTRONIC selected, specified distance set

-  (green): Active Distance Assist DISTRONIC active, specified distance set and vehicle detected

The stored speed is shown under the permanent status display and highlighted on the speedometer. When Active Distance Assist DISTRONIC is passive, the status display is grayed out.

If the speed of the vehicle in front or the speed adjustment is less than the stored speed due to the route event ahead, the segments in the speedometer light up.

When the set specified distance is increased or decreased, the  display briefly appears under the vehicle in the permanent status display.

- ① On highways or high-speed major roads, the green  vehicle symbol is displayed cyclically when the vehicle is ready to pull away.
- ① If you depress the accelerator pedal beyond the setting of the Active Distance Assist DISTRONIC, the system is switched to passive mode. The  Suspended message appears on the driver display.

System limits

The system may be impaired or may not function in the following situations, for example:

- In snow, rain, fog, heavy spray, if there is glare, in direct sunlight or in greatly varying ambient light.
- The windshield in the area of the camera is dirty, fogged up, damaged or covered.
- If the radar sensors are dirty or covered.
- In parking garages or on roads with steep uphill or downhill gradients.
- If there are narrow vehicles in front, such as bicycles or motorcycles.

In addition, on slippery roads, braking or accelerating can cause one or several wheels to lose traction and the vehicle could then skid.

Do not use Active Distance Assist DISTRONIC in these situations.

⚠ WARNING Risk of accident from acceleration or braking by Active Distance Assist DISTRONIC

Active Distance Assist DISTRONIC may accelerate or brake in the following cases, for example:

- If the vehicle pulls away using Active Distance Assist DISTRONIC.
- If the stored speed is called up and is considerably faster or slower than the currently driven speed.
- If Active Distance Assist DISTRONIC no longer detects a vehicle in front or does not react to relevant objects.

- ▶ Always carefully observe the traffic conditions and be ready to brake at all times.
- ▶ Take into account the traffic situation before calling up the stored speed.

⚠ WARNING Risk of accident due to insufficient deceleration by Active Distance Assist DISTRONIC

Active Distance Assist DISTRONIC brakes your vehicle with up to 50% of the possible deceleration. If this deceleration is not sufficient, Active Distance Assist DISTRONIC alerts you with a visual and acoustic warning.

- ▶ Adjust your speed and maintain a suitable distance from the vehicle in front.
- ▶ Brake the vehicle yourself and/or take evasive action.

⚠ WARNING Risk of accident if detection function of Active Distance Assist DISTRONIC is impaired

Active Distance Assist DISTRONIC does not react or has a limited reaction:

- when driving on a different lane or when changing lanes

- to pedestrians, animals, bicycles or stationary vehicles, or unexpected obstacles
- to complex traffic conditions
- to oncoming vehicles and crossing traffic

As a result, Active Distance Assist DISTRONIC may neither give warnings nor intervene in such situations.





- ▶ Always observe the traffic conditions carefully and react accordingly.

Operating Active Distance Assist DISTRONIC

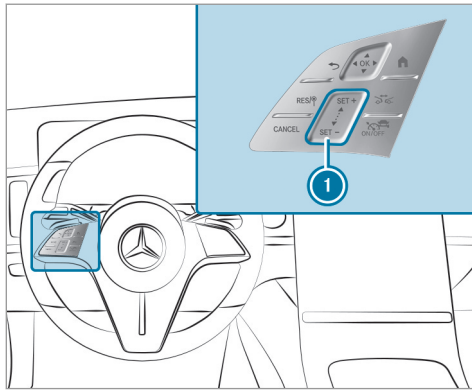
Requirements:

- The electric parking brake is released.
- ESP[®] is activated and is not intervening.
- The transmission is in position **D**.
- All the doors are closed.
- Check of the radar sensor system has been successfully completed.
- Snow chain mode is not active (→ page 374).





-  Adopts the stored/detected speed
-  Deactivates Active Distance Assist DISTRONIC
-  ① Increases/decreases the speed
-  Increases/decreases the specified distance
-  Activates/deactivates Active Distance Assist DISTRONIC

▶ **To operate Active Distance Assist DISTRONIC:** press the respective button with only one finger or swipe on the control panel.

Activating/deactivating Active Distance Assist DISTRONIC

▶ Press .

Activating Active Distance Assist DISTRONIC

▶ **To activate without a stored speed:** on control panel ① press  on the upper section or  on the lower section or . Remove your foot from the accelerator pedal.

or

▶ **To activate with a stored speed:** press . Remove your foot from the accelerator pedal. The current speed is stored and maintained by the vehicle.

Increasing or reducing the speed



▶ To increase the stored speed: swipe upwards from the bottom of control panel ①.

- The stored speed is increased by 1 mph (1 km/h).

▶ To decrease the stored speed: swipe downwards from the top of control panel ①.

- The stored speed is decreased by 1 mph (1 km/h).

or

▶ Briefly press  on the upper section or  on the lower section of control panel ①.

The stored speed is increased or reduced by 5 mph (10 km/h).

or

▶ Accelerate the vehicle to the desired speed.

▶ Press  on the upper section of control panel ①.

Adopting the limit speed shown in the driver display

▶ Activate Active Distance Assist DISTRONIC.

- ▶ Press . The limit speed displayed in the driver display is adopted as the stored speed. The vehicle adapts its speed to that of the vehicle in front, but only up to the stored speed.

Pulling away with Active Distance Assist DISTRONIC



- ▶ Activate Active Distance Assist DISTRONIC and remove your foot from the brake pedal.

- ▶ Press .

or

- ▶ Depress the accelerator pedal briefly and firmly. The functions of Active Distance Assist DISTRONIC continue to be carried out.

Reducing or increasing the specified distance from the vehicle in front

- ▶ Press . The  display appears. The specified distance is reduced by one level. If the lowest level is already selected, the selection jumps to the highest level.

Deactivating Active Distance Assist DISTRONIC

⚠ WARNING Risk of an accident due to Active Distance Assist DISTRONIC being active when you leave the driver's seat

If you leave the driver's seat while the vehicle is being braked by Active Distance Assist DISTRONIC only, the vehicle can roll away.

- ▶ Always deactivate Active Distance Assist DISTRONIC and secure the vehicle to prevent it from rolling away before you leave the driver's seat.

- ▶ Press .

i If you brake, deactivate ESP® or if ESP® intervenes, Active Distance Assist DISTRONIC is deactivated.

Function of Active Speed Limit Assist

If a change in the speed limit of 12 mph (20 km/h) or more is detected and automatic adoption of speed limits is activated, the new speed limit is automatically adopted as the stored speed (→ page 232).

The driven speed is adjusted when the vehicle is level with the traffic sign at the latest. In the case of signs indicating entry into an urban area, the speed is adapted according to the speed permitted within the urban area. The speed limit display in the driver display is always updated when the vehicle is level with the traffic sign.

If you are driving on German highways and there is no speed limit, the system uses the speed stored for a stretch of road with no speed limit as the set speed. If you do not alter the stored speed on a stretch of road with no speed limit, the recommended speed of 80 mph (130 km/h) is adopted.

If Active Distance Assist DISTRONIC has been put into passive mode by pressing the accelerator pedal, only speed limits which are higher than the set speed are adopted.

The maximum permissible speed does not take the road condition and current weather and traffic conditions into account. Adjust your speed accordingly, when necessary.

Observe the notes on driving systems and your responsibility; you may otherwise fail to recognize dangers (→ page 218).

System limits

The system limits of Traffic Sign Assist apply to the detection of traffic signs (→ page 244).

Speed limits below 12 mph (20 km/h) are not automatically adopted by the system as the stored speed. Temporary speed restrictions (e.g. for a certain time or due to weather conditions) cannot be properly detected by the system. The maximum permissible speed applying to a vehicle with a trailer is not detected by the system.

Adjust the speed in these situations.

▲ WARNING Risk of accident due to Active Speed Limit Assist adapting the vehicle's speed

The speed adopted by Active Speed Limit Assist may be too high or incorrect in some individual cases, such as:

- at speed limits below 12 mph (20 km/h)

- in wet conditions or in fog
 - when towing a trailer
- ▶ Ensure that the driven speed complies with traffic regulations.
- ▶ Adjust the driving speed to suit current traffic and weather conditions.

Function of route-based speed adaptation

When Active Distance Assist DISTRONIC is activated, the vehicle speed will be adapted accordingly to the route events ahead. Depending on the drive program selected, the vehicle negotiates a route event ahead in a fuel-saving, comfortable or dynamic manner. When the route event has been passed, the vehicle accelerates again to the stored speed. The set distance to the vehicle in front, vehicles detected ahead and speed restrictions ahead are taken into account.

Route-based speed adaptation can be activated in the multimedia system (→ page 232).

The following route events are taken into account:

- Curves

- Roundabouts
- T-intersections
- Turns and exits
- Traffic jams ahead (only with Live Traffic)

Also, the speed is reduced if the turn signal indicator is switched on and one of the following situations is detected:

- Turning off at intersections
- Driving on slowing-down lanes
- Driving on lanes adjacent to slowing-down lanes

The driver is responsible for choosing the right speed and observing other road users. This applies in particular to intersections, roundabouts and traffic lights, as route-based speed adaptation does not brake the vehicle to a standstill.

If a corresponding route event is detected while route guidance is active, the first speed adjustment is carried out automatically. If the turn signal indicator is switched on, the selected route is

confirmed and further speed adjustment is activated.

Speed adaptation is canceled in the following cases:

- If the turn signal indicator is switched off before the route event and it is therefore assumed that the route event is not relevant to the driver.
- If the driver depresses the accelerator or brake pedal during the process.

System limits

Route-based speed adaptation does not take right of way regulations into account. The driver is responsible for complying with road traffic regulations and driving at a suitable speed.

In difficult conditions, the speed selection made by the system may not always be suitable. This applies to the following situations, for example:

- Unclear roads
- Road narrowing
- Varying maximum permissible speeds in individual lanes, for example at toll plazas
- Wet road surfaces, snow or ice

In these situations the driver must intervene accordingly.

WARNING Risk of accident in spite of route-based speed adaptation

Route-based speed adaptation can malfunction or be temporarily unavailable in the following situations:

- If the driver does not follow the calculated route
 - If map data is not up-to-date or available
 - In the event of roadworks
 - In bad weather or road conditions
 - If the accelerator pedal is depressed
 - In the event of electronically displayed speed limitations
- ▶ Adapt the speed to the traffic situation.

Setting Active Distance Assist DISTRONIC driving styles

Requirements:

- Active Distance Assist DISTRONIC is activated.

Multimedia system:

  ▶ Settings ▶ Assistance
▶ Driving ▶ Active Distance Assist

Selecting a driving style

- ▶ Select **DYNAMIC SELECT based**, **Dynamic** or **Comfort**.

Setting speed adaptation

- ▶ Select **When cornering etc.** or **For limits**.
When these functions are active, the vehicle speed is adjusted according to a route event ahead or to speed limits detected by Traffic Sign Assist.

-  When one of the following systems is active, the detected speed can be manually adopted as the speed limit:
 - Active Distance Assist DISTRONIC

- Variable limiter

Further information about Active Distance Assist DISTRONIC (→ page 228).

-  Further information on speed adaptation (→ page 231).

Function of Active Stop-and-Go Assist

Active Stop-and-Go Assist helps you when in traffic jams on multi-lane roads with separate roadways by automatically pulling away within up to 60 seconds and with moderate steering maneuvers. It orients itself using the vehicle in front and lane markings. Active Stop-and-Go Assist automatically maintains a safe distance from the vehicle in front and vehicles cutting in.

Active Stop-and-Go Assist requires you, as the driver, to keep your hands on the steering wheel at all times so that you are able to intervene at any time to correct the course of the vehicle and keep it in lane.

Observe the notes on driving systems and your responsibility; you may otherwise fail to recognize dangers (→ page 218).

Active Stop-and-Go Assist activates automatically when all of the following conditions are met:

- You are in a traffic jam on a freeway or high-speed major road.
- Active Distance Assist DISTRONIC is activated and active (→ page 228).
- Active Steering Assist is activated and active (→ page 235).
- You are traveling no faster than 35 mph (60 km/h).

When Active Stop-and-Go Assist is active the  status display appears in the driver display.

System limits

The system limitations of Active Distance Assist DISTRONIC and Active Steering Assist apply to Active Stop-and-Go Assist (→ page 233).

Active Steering Assist

Function of Active Steering Assist

Active Steering Assist is only available up to a speed of 130 mph (210 km/h). The system helps

you to stay in the center of the lane by means of moderate steering interventions. Depending on the speed driven, Active Steering Assist uses the vehicles ahead and lane markings as a reference.

-  Depending on the country, in the lower speed range Active Steering Assist can use the surrounding traffic as a reference. If necessary, Active Steering Assist can then also provide assistance when driving away from the center of the lane.

If the detection of lane markings and vehicles ahead is impaired, Active Steering Assist switches to passive mode. The system provides no support in this case.

Permanent status display on the driver display



Gray: activated and passive





Green: activated and active



Red, flashing: prompt to the driver to actively confirm or transition from active to passive status, system limit detected

234 Driving and parking

- ① During the transition from active to passive status, the  symbol is shown as enlarged and flashing. Once the system is passive, the  symbol is shown as gray on the driver display.

Contact detection

The driver is required to keep their hands on the steering wheel at all times and be able to intervene at any time to correct the course of the vehicle and keep it in lane. The driver must expect a change from active to passive mode or vice versa at any time.



If the system detects that the driver has not steered the vehicle for a considerable period of

time or has removed their hands from the steering wheel, an optical warning is given first. Display message ① appears on the driver display. If the driver still does not steer the vehicle, or gives no confirmation to the system, a warning tone sounds in addition to the visual warning message.

If the driver does not react to this warning for a considerable period, an emergency stop is initiated (→ page 235).

The warning is not issued or is stopped as soon as the system detects that the driver has touched the steering wheel.

Touch detection may be limited or inoperative in the following situations:

- The driver is wearing gloves.
- There is a steering wheel cover on the steering wheel.

If Active Steering Assist detects that a system limit has been reached, a visual warning is issued and a warning tone sounds.

Observe the notes on driving systems and your responsibility; you may otherwise fail to recognize dangers (→ page 218).

System limits

Active Steering Assist has a limited steering torque for lateral guidance. In some cases, the steering intervention is not sufficient to keep the vehicle in the lane.

The system may be impaired or may not function in the following instances:

- There is poor visibility, e.g. due to snow, rain, fog, heavy spray, greatly varying ambient light or strong shadows on the road.
- There is glare, e.g. from oncoming traffic, direct sunlight or reflections.
- Insufficient road illumination.
- The windshield is dirty, fogged up, damaged or covered in the vicinity of the camera, e.g. by a sticker.
- No, or several, unclear lane markings are present for one lane, or the markings change quickly, for example, in a construction area or at intersections.

- The lane markings are worn away, dark or covered up, e.g. by dirt or snow.
- If the distance to the vehicle in front is too short and thus the lane markings cannot be detected.
- The road is narrow and winding.
- There are obstacles on the lane or projecting out into the lane, such as object markers.

The system does not provide assistance in the following conditions:

- On very tight curves and when turning.
- When crossing intersections.
- At roundabouts or toll plazas.
- When actively changing lane without switching on the turn signal indicator.
- When the tire pressure is too low.

⚠ WARNING Risk of accident if Active Steering Assist unexpectedly stops functioning

If the system limits of Active Steering Assist are reached there is no guarantee that the system will remain active or will keep the vehicle in lane.

- ▶ Always keep your hands on the steering wheel and observe the traffic carefully.
- ▶ Always steer the vehicle paying attention to traffic conditions.

⚠ WARNING Risk of accident if Active Steering Assist unexpectedly intervenes

The detection of lane markings and objects may malfunction and cause unexpected steering interventions.

- ▶ Steer according to traffic conditions.

Activating/deactivating Active Steering Assist

Requirements:

- ESP® is activated, but is not intervening.
- Active Distance Assist DISTRONIC is activated.

Multimedia system:

- ▶  ▶ Settings ▶ Assistance
- ▶ ▶ Driving
- ▶ Select  Act. Steering Asst. .

Function of Active Emergency Stop Assist

Active Emergency Stop Assist uses touch sensors to monitor whether the driver holds the steering wheel and initiates an emergency stop if necessary.

If Active Steering Assist is deactivated, the accelerator and brake pedal are monitored as well as the steering wheel. A warning is issued when the steering wheel is not being held or when a pedal is not depressed, and the vehicle is in danger of leaving the lane.

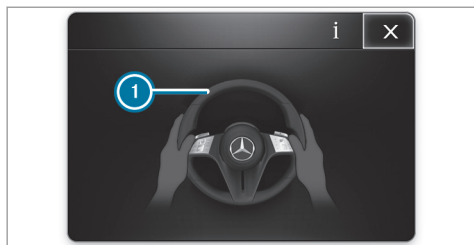

If the system detects that the driver has not steered the vehicle for a considerable period of time or has removed their hands from the steering wheel, visual warning ① is issued. If the driver still does not steer the vehicle, or gives no confirmation to the system, a warning tone sounds in addition to the visual warning message.

Also observe the instructions on the contact detection of Active Steering Assist (→ page 233).

Active Emergency Stop Assist issues the following warnings in order:

- Display message ① appears in the driver's display.
- In addition to display ① a warning tone sounds.
- The **Beginning Emergency Stop** message appears on the driver display, a continuous warning tone sounds, the vehicle no longer accelerates, and there is a slight, repeated tensioning of the seat belt.
- The vehicle speed is reduced in increments until it is at a standstill. Sharp brake impulses are also produced.

Depending on the country, a lane change to the adjacent right-hand lane is carried out, if possible.

- ① It is only possible to change across one lane and only into the right-hand lane, and not onto the hard shoulder.

When automatic braking is initiated, Active Distance Assist DISTRONIC is deactivated. Depend-

ing on the country, the hazard warning light system is switched on.

When the vehicle is stationary, the following actions are carried out:

- The vehicle is secured with the electric parking brake.
- The vehicle is unlocked.
- If possible, an emergency call is placed to the Mercedes-Benz emergency call center.

Before automatic braking is initiated, you can cancel Active Emergency Stop Assist by steering.

You can cancel the intervention by Active Emergency Stop Assist after automatic braking is initiated by one of the following actions:

- Accelerating or braking: the emergency stop is canceled, but the warning message, warning tone and power steering remain active
- Steering: power-assisted steering is canceled, the warning message and warning tone remain active and the vehicle continues to be braked

- ⓘ Active Emergency Stop Assist can initiate an emergency stop a maximum of three times within one ignition cycle. After this Active Steering Assist and Active Emergency Stop Assist are deactivated for that ignition cycle.

System limits

If Active Lane Keeping Assist does not detect lane markings, Active Emergency Stop Assist is not active.

For the detection of vehicles and other obstacles, observe the system limits of the following functions:

- Active Distance Assist DISTRONIC (→ page 226)
- Active Steering Assist (→ page 233)
- Active Lane Change Assist (→ page 237)

Active Lane Change Assist

Function of Active Lane Change Assist

Active Lane Change Assist supports the driver when changing lanes and is activated by indicating briefly.

Active Lane Change Assist is only an aid and not a substitute for your attention. It is essential that you observe the notes on driving systems and your responsibility in the vehicle Operator's Manual; you may otherwise fail to recognize dangers.

The following conditions must be fulfilled for a lane change:

- You are on a highway or high-speed major road.
- The vehicle speed is between approximately 50 mph (80 km/h) and 110 mph (180 km/h).
- The neighboring lane is separated by a broken lane marking.
- No vehicle or obstacle is detected in the adjacent lane.
- Since the last time the vehicle was started, the sensors have detected a vehicle at a suitable distance behind your vehicle.
- Active Lane Change Assist is selected in the multimedia system.
- Active Distance Assist DISTRONIC and Active Steering Assist are activated on highways.

The system is not available and must be reactivated in the following situations:



- Active Distance Assist DISTRONIC and Active Steering Assist were already activated before entering the highway.
- The system briefly does not detect the road you are on as a highway or a similar road, e.g. on a freeway intersection.

As soon as Active Lane Change Assist detects a suitable road, you can reactivate it with **RES**, **SET+** or **SET-**.

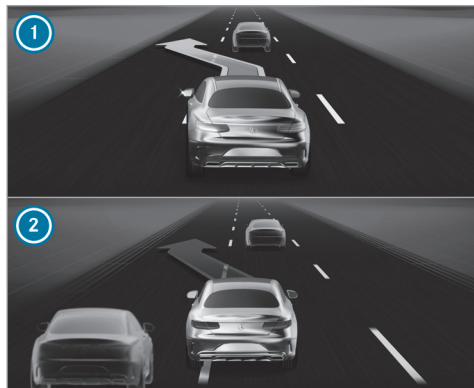
Driver display in the Assistance menu



- ① Green arrow: lane change initiated
- ② Red arrow: lane change canceled

When Active Lane Change Assist is available, the  display appears along with green arrows in the driver display. If the system has been activated but is not currently available, the  dis-

play appears along with gray arrows in the driver display.

If no vehicle or obstacle is detected in the adjacent lane and a lane change is permitted, the lane change begins after the driver has indicated briefly. The lane change is shown to the driver with a flashing green arrow next to the  steering wheel symbol. Green arrow ① is displayed in the appropriate adjacent lane in the Assistance menu in the driver display. The Lane Change to the Left message, for example, also appears.

Active Lane Change Assist can be canceled in various situations, including the following:

- Change in the surrounding conditions (e.g. detected obstacle).
- The driver removes their hands from the steering wheel.
- The driver steers with too much force or in the opposite direction.
- The driver moves the turn signal indicator in the opposite direction.

- Active Distance Assist DISTRONIC or Active Steering Assist is deactivated.
- The vehicle cannot make the lane change as planned.

Cancellation of Active Lane Change Assist is displayed as follows:

- The arrow in the selected direction of travel turns red.
- A corresponding message appears on the driver display.
- In certain circumstances a warning tone sounds.

⚠ WARNING Risk of accident when changing lane to an occupied adjacent lane

Lane Change Assist cannot always clearly detect if the adjacent lane is free.

The lane change might be initiated although the adjacent lane is not free.

▶ Before changing lanes, make sure that the neighboring lane is free and there is no danger to other road users.

- ▶ Monitor the lane change.

⚠ WARNING Risk of accident if Lane Change Assist unexpectedly stops functioning

If the system limitations for Lane Change Assist have been reached, there is no guarantee that the system will remain active.

Lane Change Assist cannot then assist you by applying steering torque.

- ▶ Always monitor the lane change and keep your hands on the steering wheel. Observe the traffic conditions and steer and/or brake if necessary.

System limits

The system may be impaired or may not function in the following instances:

- There is poor visibility, e.g. due to snow, rain, fog, heavy spray, greatly varying ambient light or strong shadows on the road.
- There is glare, e.g. from oncoming traffic, direct sunlight or reflections.



- Due to insufficient illumination of the road, or if the exterior lighting indicates a malfunction.
- The windshield is dirty, fogged up, damaged or covered in the vicinity of the camera, e.g. by a sticker.
- The sensors are damaged, covered or dirty.
- No, or several, unclear lane markings are present for one lane, or the markings change quickly, for example, in a construction area or intersections.
- The system does not detect a suitable road, for example, in tight curves or shortly after an access road.
- The lane markings are worn away, dark or covered up, e.g. by dirt or snow.
- If the distance to the vehicle in front is too short and thus the lane markings cannot be detected.
- There are obstacles on the lane or projecting out into the lane, such as object markers.
- When the tire pressure is too low.

Also observe the system limits of Active Steering Assist and the information on vehicle sensors and cameras in the vehicle Operator's Manual.

- ① The Active Lane Change Assist sensors adjust automatically while a certain distance is being driven after the vehicle has been delivered. Active Lane Change Assist is unavailable or only partially available during this teach-in process, and no arrows are displayed next to the  Active Steering Assist symbol.

Selecting Active Lane Change Assist

Multimedia system:

- ▶  ▶ Settings ▶ Assistance
- ▶  ▶ Driving
- ▶ Select the function.

Active Brake Assist

Function of Active Brake Assist

Active Brake Assist consists of the following functions:

- Distance warning function

- Autonomous braking function
- Situation-dependent braking assistance
- Evasive Steering Assist (country-specific)

Active Brake Assist can help you to minimize the risk of a collision with vehicles, cyclists or pedestrians or to reduce the effects of such a collision.

If Active Brake Assist has detected a risk of collision, a warning tone sounds and the  distance warning lamp lights up.

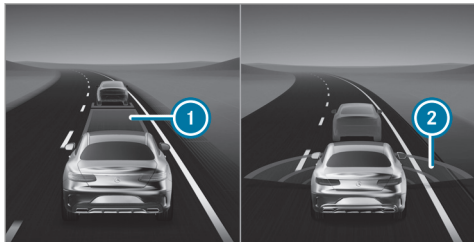

In the **Assistance** menu, an insufficient distance  to the vehicle in front is displayed in red. If you further reduce the distance, the vehicle in

front is also highlighted in red. When the system detects a risk of collision, red radar waves  appear in front of the vehicle.

Vehicles with PRE-SAFE®: depending on the country, an additional haptic warning occurs in the form of slight, repeated tensioning of the seat belt.

 **Vehicles with active ambient lighting:** if **Warning Support** is activated, the Active Brake Assist warning is also accompanied by ambient lighting (→ page 166).

If you do not react to the warning, autonomous braking can be initiated in critical situations.

In particularly critical situations, Active Brake Assist can also initiate autonomous braking directly. In this case, the warning lamp and warning tone occur simultaneously with the braking application.

If you apply the brake yourself in a critical situation or apply the brake during autonomous braking, situation-dependent braking assistance occurs. The brake pressure increases up to maximum full-stop braking if necessary.



If autonomous braking or situation-dependent braking assistance has occurred, pop up  appears in the driver display and then automatically goes out after a short time.

If the autonomous braking function or the situation-dependent braking assistance is triggered, additional preventive measures for occupant protection (PRE-SAFE®) may also be initiated.

▲ WARNING Risk of an accident caused by limited detection performance of Active Brake Assist



Active Brake Assist cannot always clearly identify objects and complex traffic situations.

In such cases, Active Brake Assist might:

- Give a warning or brake without reason
- Not give a warning or not brake

Active Brake Assist is only an aid. The driver is responsible for maintaining a sufficiently safe distance to the vehicle in front, vehicle speed and for braking in good time.

- ▶ Always pay careful attention to the traffic situation; do not rely on Active Brake Assist alone.
- ▶ Be prepared to brake or swerve if necessary.

- i** If Active Brake Assist is deactivated,  appears in the driver display. If the system is unavailable or the functions are restricted,  appears.

Also observe the system limits of Active Brake Assist.

The individual subfunctions are available in the following speed ranges:

The distance warning function issues a warning in the following situations:

- From approximately 4 mph (7 km/h), if your vehicle is critically close to a vehicle, cyclist or pedestrian, you will hear an intermittent warning tone and the  distance warning lamp lights up in the driver display.

Vehicles with PRE-SAFE®: depending on the country, an additional haptic warning occurs in the form of slight, repeated tensioning of the seat belt.

If possible, brake immediately or maneuver to avoid the obstacle.

Distance warning function

The distance warning function can assist you by means of an intermittent warning tone and a warning lamp:

- At speeds up to approximately 155 mph (250 km/h) when approaching vehicles ahead.
- At speeds up to approximately 75 mph (120 km/h) when approaching crossing vehicles, pedestrians and cyclists.
- At speeds up to approximately 62 mph (100 km/h) when approaching stationary vehicles.
- At speeds up to approximately 50 mph (80 km/h) when approaching cyclists ahead.
- At speeds up to approximately 43 mph (70 km/h) when approaching stationary pedestrians and cyclists.

Autonomous braking function

The autonomous braking function can intervene from speeds of approximately 4 mph (7 km/h):

- At speeds up to approximately 155 mph (250 km/h) when approaching vehicles ahead.
- At speeds up to approximately 75 mph (120 km/h) when approaching crossing vehicles, pedestrians and cyclists.
- At speeds up to approximately 62 mph (100 km/h) when approaching stationary vehicles.
- At speeds up to approximately 50 mph (80 km/h) when approaching cyclists ahead.
- At speeds up to approximately 43 mph (70 km/h) when approaching stationary pedestrians and cyclists.

Situation-dependent braking assistance

Situation-dependent braking assistance can intervene from speeds of approximately 4 mph (7 km/h):

- At speeds up to approximately 155 mph (250 km/h) when approaching vehicles ahead.
- At speeds up to approximately 75 mph (120 km/h) when approaching crossing vehicles, pedestrians and cyclists.
- At speeds up to approximately 62 mph (100 km/h) when approaching stationary vehicles.
- At speeds up to approximately 50 mph (80 km/h) when approaching cyclists ahead.
- At speeds up to approximately 43 mph (70 km/h) when approaching stationary pedestrians and cyclists.

Canceling a brake application of Active Brake Assist

You can cancel a brake application of Active Brake Assist at any time by:

- Fully depressing the accelerator pedal or with kickdown.
- Releasing the brake pedal.

Active Brake Assist may cancel the brake application when one of the following conditions is fulfilled:

- You maneuver to avoid the obstacle
- There is no longer a risk of collision
- An obstacle is no longer detected in front of your vehicle

Reaction to oncoming road users

Active Brake Assist can also react to detected oncoming road users:

- Reaction up to speeds of approximately 62 mph (100 km/h)
- Warning for oncoming road users through acoustic warning and warning lamp

- Autonomous braking application in order to reduce the severity of an accident

Evasive Steering Assist

▲ WARNING Risk of accident despite Evasive Steering Assist

Evasive Steering Assist cannot always recognize objects or complex traffic situations clearly.

Moreover, the steering support provided by Evasive Steering Assist is not sufficient to avoid a collision.

- ▶ Always pay careful attention to the traffic situation; do not rely on Evasive Steering Assist alone.
- ▶ Be prepared to brake or swerve if necessary.
- ▶ End the support by actively steering in non-critical situations.
- ▶ Drive at an appropriate speed if there are pedestrians close to the path of your vehicle.

Evasive Steering Assist has the following characteristics:

- Detection of pedestrians, cyclists and vehicles.
- Assistance through power-assisted steering if it detects a swerving maneuver.
- Activation by an abrupt steering movement during a swerving maneuver.
- Assistance during swerving and straightening of the vehicle.
- Reaction from a speed of approximately 13 mph (20 km/h) up to a speed of approximately 68 mph (110 km/h).

The steering support of Evasive Steering Assist can be canceled at any time by counter steering.

System limits

Full system performance is not available for a few seconds after switching on the ignition or after driving off.

If the system is unavailable or the functions are restricted, the  warning lamp appears in the driver's display.

The system may be impaired or may not function, particularly in the following situations:

- In snow, rain, fog, heavy spray, if there is glare, in direct sunlight or in greatly varying ambient light.
- If the sensors are dirty, fogged up, damaged or covered (→ page 218).
- If the sensors are impaired due to interference from other radar sources, e.g. strong radar reflections in parking garages.
- If a loss of tire pressure or a faulty tire has been detected and displayed.
- In complex traffic situations where objects cannot always be clearly identified.
- If pedestrians, cyclists or vehicles move quickly into the sensor detection range.
- If road users are hidden by other objects or are located close to other objects.
- If the typical outline of a pedestrian or cyclist cannot be distinguished from the background.

- If a pedestrian or cyclist is not detected as such, e.g. due to special clothing or other objects.
 - If the driver's seat belt is not fastened.
 - On curves with a tight radius.
- ⓘ The Active Brake Assist sensors adjust automatically while a certain distance is being driven after the vehicle has been delivered. Active Brake Assist is unavailable or only partially available during the teach-in process.

Setting Active Brake Assist

Requirements:

- The ignition is switched on.

Multimedia system:

→  **» Settings » Assistance**
» Avoid collision » Active Brake Assist

- ▶ Select the desired setting.
The setting is retained when the engine is next started.

Deactivating Active Brake Assist

- ⓘ It is recommended that you always leave Active Brake Assist activated.
- ▶ Select **Off**.
The distance warning function, the autonomous braking function and the Evasive Steering Assist are deactivated.
When the engine is next started, the medium setting is automatically selected.
- ⓘ If Active Brake Assist is deactivated, the  symbol appears in the status bar of the multifunction display.

Traffic Sign Assist

Function of Traffic Sign Assist

Traffic Sign Assist detects traffic signs with the multifunction camera and compares this with information in the digital navigation map. It assists you by displaying detected speed limits and overtaking restrictions on the driver display and on the Head-up Display. The system can issue a warning when you exceed the maximum permissible speed.

In some countries, the system can provide you with further functions and can warn you when you are approaching pedestrian crossings or when you are about to drive past stop signs or red lights unintentionally.

The camera also detects and analyzes traffic signs with a restriction indicated by an additional sign (e.g. when wet).

Traffic Sign Assist only visualizes selected signs on the driver display. Actual traffic signs and speed limits have priority over traffic signs and speed limits shown on the driver display.

Also observe the following information:

- Select a speed adapted to the traffic, surroundings and weather conditions
- Observe actual traffic signs
- Observe applicable traffic rules and regulations

Observe the notes on driving systems and your responsibility; you may otherwise fail to recognize dangers (→ page 218).

Messages on the driver display

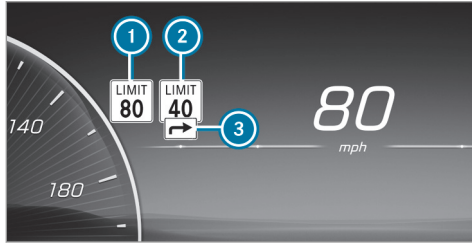

- ① Permissible speed
- ② Permissible speed when there is a restriction
- ③ Additional sign with restriction

The system can show up to two traffic signs on the driver display simultaneously. The system always prioritizes displaying speed limits. Up to one traffic sign with a maximum permissible speed can be shown on the Head-up Display. If two speed signs are shown on the driver display, for example, when speed limits are detected, the value of left-hand speed limit ① is transmitted to the limiter or Active Distance Assist

DISTRONIC for adoption and is shown on the Head-up Display.

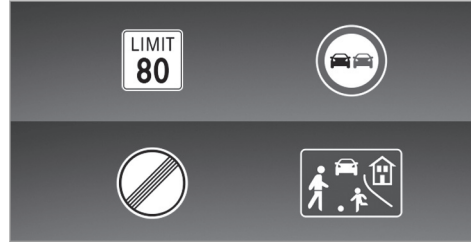

Examples of traffic signs which can be displayed

Traffic Sign Assist can detect and display following traffic signs ①:

- Speed limits
- End of the speed limit
- Overtaking restrictions
- Play streets
- Signs showing the start or end of highways
- Signs showing the start or end of expressways

- Recommended speeds

Traffic Sign Assist can detect following additional signs ③ and, if necessary, analyze the relevance of the restrictions using other vehicle sensors:

- When wet
- Slippery road surfaces
- In fog
- Temporary restrictions
- Exits
- Restrictions for vehicle/trailer combinations

Traffic Sign Assist also uses data from the digital street map in the navigation system. When you leave or enter a municipality or change roads, on a freeway exit or access road for example, or after you turn at an intersection, the display on the driver display can thus be updated without a traffic sign having been detected.

In addition, the system can display speed limits ahead on the driver display and the Head-up Display. The driver display can also show the distance to an upcoming lower limit speed. For this

purpose, information from the digital road map of the navigation system is used. Depending on the current situation and the assumed route, the display message is shown up to 380 yds (350 m) in advance. The **Assistance** menu can also display a dynamic visualization of the speed limits ahead.

If Traffic Sign Assist cannot determine the currently applicable maximum permissible speed (e.g. due to missing signs), the following display appears on the driver display:



Traffic Sign Assist is not available in all countries. If the vehicle is in a country where Traffic Sign Assist is not supported, this is displayed continuously.

i Also observe the information on display messages in Traffic Sign Assist (→ page 503).

Warning when the maximum permissible speed is exceeded

The system can warn you if you unintentionally exceed the maximum permissible speed. To do this, you can specify in the multimedia system by how much the maximum permissible speed can be exceeded before a warning is issued. You can set the warning to visual only (the traffic sign flashes three times on the driver display) or visual and acoustic, including a warning tone.

Additional functions of Traffic Sign Assist (country-specific)

Warning for no-entry signs: Traffic Sign Assist can warn you if you drive the wrong way down a section of road, for example on freeway access roads or one-way streets.

Warning at pedestrian crossings: If you approach pedestrian crossings, provided that pedestrians are in the danger zone or are moving towards it, Traffic Sign Assist can warn you up to a speed of approximately 44 mph (70 km/h).

Warning at stop signs: Traffic Sign Assist can warn you up to a speed of approximately 44 mph (70 km/h) if you are about to drive past a stop

sign unintentionally. For this to be possible, the signs must be clear, for example if the system detects more than one stop sign, or a stop sign can be confirmed using the digital navigation map. No warning can be issued if several different signs are detected.

Warning at red lights: Traffic Sign Assist can warn you up to a speed of approximately 44 mph (70 km/h) if you are about to drive through a red light unintentionally.

The following conditions must be fulfilled:

- Several traffic lights have been detected.
- All traffic lights detected are red.
- At least one of the red traffic lights detected is on the front passenger side beside the vehicle's own lane.
- The traffic lights are in the following sequence (from top to bottom): red, yellow, green.

i If the function is available, you can activate or deactivate the warnings at pedestrian crossings, stop signs and red lights in the Traffic Sign Assist menu under [Further Warnings](#) (→ page 247).

System limits

The system may be impaired or may not function particularly in the following situations:

- If visibility is poor, e.g. due to insufficient illumination of the road, highly variable shade conditions, rain, snow, fog, swirling dust or heavy spray.
- If there is glare, e.g. from oncoming traffic, direct sunlight or reflections.
- If the windshield in the area of the multifunction camera is dirty, or if the camera is fogged up, damaged or covered.
- If traffic signs are difficult to detect, e.g. because they are dirty, covered, faded, covered with ice, damaged, badly positioned, poorly lit or twisted.
- Active traffic signs with LED displays may not be detected correctly or at all due to technical factors, such as transmission frequency.
- If the information on the navigation system's digital map is incorrect, incomplete or out of date.
- If signs or the road layout is ambiguous, e.g. traffic signs in roadworks, at exits and ramps, in neighboring lanes or parallel roads.
- If signs do not conform to the standard.
- If signs or road layouts are specific to the country and deviate from the route guidance in the navigation system, e.g. at or beyond construction sites.
- After sharp turns and tight curves, when traffic signs are outside the camera's field of vision.
- If you overtake vehicles with traffic signs which are affixed or attached to them.

Setting Traffic Sign Assist



Multimedia system:

  **» Settings** **» Assistance**
» Assistance **» Traffic Sign Assist**

Activating or deactivating the speed warning

 Activate or deactivate [Speed Limit Warning](#).

Setting the type of warning

 Select  next to [Speed Limit Warning](#).
 Select [Visual & Audible](#) or [Visual](#).

Setting the warning threshold

This value determines the speed at which a warning is issued when exceeded.

 Set the desired speed under [Warning Threshold](#).

Activating or deactivating further functions of Traffic Sign Assist

 Activate or deactivate [Further Warnings](#).
The available functions are activated or deactivated.

Setting the type of warning for further functions

- ▶ Select  next to [Further Warnings](#).
- ▶ Select [Visual & Audible](#) or [Visual](#).

Traffic light view

Information about the traffic light view

The traffic light view supports the driver when waiting in front of a red light by displaying the camera image on the central display. The camera image is displayed when the driver is the first vehicle in front of the red light and faded out when the vehicle drives off.

Displaying traffic light view

Requirements:

- The [Traffic Light View](#) option is switched on.
- A traffic light view is available.



Multimedia system:

- ▶  ▶ [Settings](#) ▶ [Assistance](#)
- ▶ [Assistance](#) ▶ [Traffic Light View](#)

 This function is not available in all countries.

If the vehicle is in first position at a traffic light, the camera image with traffic light view is shown in the central display.

When the vehicle pulls away, the camera image is faded out.

- ▶ Activate  or deactivate  [Traffic Light View](#).

Using other available functions

- ▶ Select .
- ▶ Select [On Request](#) or [Automatic](#).

If [On Request](#) is set and a traffic light view is available, the [Tap Here for Traffic Light View](#) message is displayed. The camera image is shown after confirmation of the message.

When [Automatic](#) is set, the camera image is automatically displayed when the traffic light view is available.

Overview of the traffic light data service

 **WARNING** Risk of an accident or injury due to distraction, incorrect or missing data

The traffic light information display is an aid and cannot replace the observation of the actual driving situation.

- ▶ Keep the actual traffic situation constantly in view when approaching a traffic light and when changing lanes.
- ▶ Avoid prolonged viewing of the Instrument Display and Head-up Display.

The traffic lights and countdown of remaining time  until the next green phase are shown in the driver display.



Example representation in the driver display

The display is hidden about five seconds before the traffic lights change to green.

- ① The display also goes out in the following cases:
 - When turning off before the intersection into a cross or side street
 - When turning before the intersection
- ① The direction arrows are displayed depending on the following functions:
 - A turn signal is set
 - A lane is recommended during active route guidance

If neither function is active, the remaining time until the next green phase for the lane straight ahead is displayed.

- ① Use of the traffic light information service requires the regular transmission of vehicle positions and driving directions to Mercedes-Benz. The data is immediately anonymised by Mercedes-Benz and forwarded to the provider of the traffic light information service. The vehicle positions and driving directions are deleted after a very short time (a few seconds) and are not permanently saved.

If you do not want to transmit the vehicle positions and driving directions, you have the following options:

- You deactivate the service in the Mercedes me portal.
- You have the service deactivated at an authorized Mercedes-Benz Center.
- ① This traffic light data service is only available in certain cities and regions.

The function is supported under the following conditions:

- The vehicle is equipped with a multimedia system featuring navigation and a communication module with an activated, integrated SIM card.
- You have a user account for the Mercedes me Portal.
- The vehicle has been connected with the user account.
- The navigation services option is available, subscribed to and activated in the Mercedes me Portal.
- The traffic light data service is within the scope of the navigation service.

The current vehicle position and the direction of travel are transmitted via the communication module and aligned with the data from the traffic light data service provider. The provider gathers data from traffic lights which transmit their changing phases. When the vehicle approaches an intersection with networked traffic lights, data is transmitted to the vehicle.

A set turn signal left or right and lane recommendations during active route guidance are taken into account for the display.

The service is for information purposes only and is not linked to any other vehicle functions, systems or components. Please note that the displayed data is not available in all traffic areas and may be incorrect.

Certain light signal systems automatically adapt their switching times to the current traffic situation. This can lead to a sudden change in the countdown display.

The driver display is shown after selecting the [Assistance](#) menu. If another menu is selected, the traffic light countdown is not displayed.

Also observe the following information:

- Select a speed adapted to the traffic, surroundings and weather conditions
- Observe actual traffic signs
- Observe applicable traffic rules and regulations

Observe the notes on driving systems and your responsibility; you may otherwise fail to recognize dangers.

System limits

The display does not appear in the following situations, for example:

- There is no traffic light data available.
- The time remaining until the next green phase is less than ten seconds.
- Emergency vehicles or local public transport are located in the vicinity of the intersection.
- The data transmission from the vehicle has been interrupted.
- Light signal systems are located in a construction site area or are being maintained.
- The light signal system is malfunctioning.
- The subscription to the service has expired.

[Active Blind Spot Assist with exit warning](#)

Function of Active Blind Spot Assist with exit warning

Active Blind Spot Assist uses radar sensors to monitor the area up to 130 ft (40 m) behind and 10 ft (3 m) next to your vehicle.

The system can detect vehicles traveling from speeds of approximately 8 mph (12 km/h) and issue a warning if they move into the monitoring range.

Status display in the driver's display



Gray: the system is activated but inoperative.



Green: the system is activated and operational.

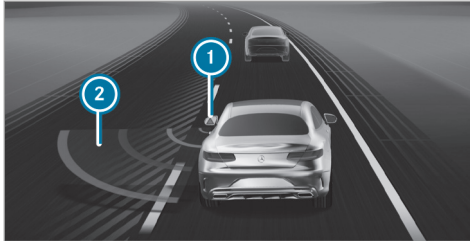

Driver display in the [Assistance](#) menu

If a vehicle is detected within the monitoring range, the red warning lamp lights up in the corresponding outside mirror. In the Assistance menu, the lamp in outside mirror ① also lights up red, and the lane in which the vehicle is detected is hatched out.

If a vehicle is detected in the monitoring range and you switch on the turn signal indicator in the corresponding direction, a warning tone sounds twice and the warning lamp flashes red in the respective outside mirror. Red radar waves ② are displayed next to your vehicle in the Assistance graphic.

If the turn signal indicator remains on, the display in the outside mirror flashes for all other detected vehicles, but no further warning tone sounds. If you overtake a vehicle quickly, no warning is given.

① **Vehicles with active ambient lighting:** if [Warning Support](#) is activated, the Active Blind Spot Assist warning is also accompanied by ambient lighting (→ page 166).

Observe the notes on driving systems and your responsibility; you may otherwise fail to recognize dangers (→ page 218).

⚠ WARNING Risk of accident despite Active Blind Spot Assist

Active Blind Spot Assist does not react to the following:

- if you overtake a vehicle too closely so that it is in the blind spot area
- if vehicles traveling at a much faster speed approach and then overtake

Active Blind Spot Assist may not give warnings or intervene in such situations.

- ▶ Always pay careful attention to the traffic situation and maintain a safe distance at the side of the vehicle.

Exit warning

The exit warning is an additional function of Active Blind Spot Assist and can warn vehicle occupants attempting to leave the stationary vehicle about approaching vehicles.

⚠ WARNING Risk of accident despite exit warning

The exit warning neither reacts to stationary objects nor to persons or road users approaching you at a greatly differing speed.

The exit warning cannot warn drivers in these situations.

- ▶ Always pay particular attention to the traffic situation when opening the doors and make sure there is sufficient clearance.

If a vehicle is detected in the monitoring range, the red warning lamp lights up in the corresponding outside mirror.

If a vehicle occupant pulls the door handle on the side of the warning, a warning tone sounds twice and the ambient lighting in the respective door and the warning lamps in the corresponding outside mirror flash red.

Vehicles with MBUX Interior Assistant: the visual warning begins as soon as the hand of a vehicle occupant moves in to the area of the door.

- ① **Vehicles with ambient lighting or active ambient lighting:** the [Warning Support](#) of the ambient lighting can be activated and deactivated (→ page 166).
- ① The warning assistance can differ depending on the equipment and may vary according to the setting.

The exit warning is only available when Active Blind Spot Assist is activated and up to a maximum of three minutes after the ignition has been switched off. The exit warning is no longer

available once the warning lamp in the outside mirror flashes three times.

The exit warning is only an aid and not a substitute for the attention of vehicle occupants. The responsibility for opening and closing the doors and for leaving the vehicle remains with the vehicle occupants.

System limits

Active Blind Spot Assist may be limited in the following situations, in particular:

- If there is dirt on the sensors or the sensors are obscured
- In poor visibility, e.g. due to fog, heavy rain or snow
- If there are narrow vehicles, e.g. bicycles or motorbikes
- If the road has very wide or narrow lanes
- If vehicles are not driving in the middle of their lane

Warnings may be issued in error when driving close to crash barriers or similar continuous lane borders. Always make sure that there is suffi-

cient distance to the side for other traffic or obstacles.

Warnings may be interrupted when driving alongside long vehicles, for example trucks, for a prolonged time.

Active Blind Spot Assist is not operational when reverse gear is engaged.

Additionally, the exit warning may be limited in the following situations:

- When the sensors are covered by adjacent vehicles in narrow parking spaces
- When people approach the vehicle
- In the event of stationary or slowly moving objects

Function of the brake application of Active Blind Spot Assist

If Active Blind Spot Assist detects a risk of a side impact in the monitoring range, a course-correcting brake application is carried out. This is designed to help you avoid a collision.

The course-correcting brake application is available in the speed range between approximately 20 mph (30 km/h) and 125 mph (200 km/h).

⚠ WARNING Risk of accident despite brake application of Active Blind Spot Assist

A course-correcting brake application cannot always prevent a collision.

- ▶ Always steer, brake or accelerate yourself, especially if Active Blind Spot Assist warns you or makes a course-correcting brake application.
- ▶ Always maintain a safe distance at the sides.

⚠ WARNING Risk of accident despite Active Blind Spot Assist

Active Blind Spot Assist does not react in the following situations:

- If you overtake vehicles at a high speed.
- If vehicles approach and overtake you at a greatly different speed.

Active Blind Spot Assist may not give warnings or intervene in such situations.

- ▶ Always pay careful attention to the traffic situation and maintain a safe distance at the side of the vehicle.



If a course-correcting brake application occurs, the red warning lamp flashes in the outside mirror and a warning tone sounds. In addition, a display **1** indicating the danger of a side collision appears in the driver's display.

In rare cases, the system may make an inappropriate brake application. This brake application may be interrupted at any time if you steer slightly in the opposite direction or accelerate.

System limits

Either a course-correcting brake application appropriate to the driving situation, or none at all, may occur especially in the following situations:

- Vehicles or obstacles, e.g. crash barriers, are located on both sides of your vehicle.
- A vehicle approaches too closely on the side.
- You have adopted a sporty driving style with high cornering speeds.
- You brake or accelerate significantly.
- A driving safety system intervenes, e.g. ESP® or Active Brake Assist.
- ESP® is deactivated.
- A loss of tire pressure or a faulty tire is detected.

Activating/deactivating Active Blind Spot Assist

Multimedia system:

→  >> Settings >> Assistance

>> Collision Avoidance

>> Active Blind Spot Assist

▶ Select Active Blind Spot Assist.

▶ Select On or Off.

Active Lane Keeping Assist

Function of Active Lane Keeping Assist

Active Lane Keeping Assist monitors the area in front of your vehicle by means of the multifunction camera (→ page 218) and can warn you before you leave your lane unintentionally. The system can guide you back into your lane through a course-correcting steering intervention and additionally warns you with vibration pulses in the steering wheel. Active Lane Keeping Assist is available in the speed range between 37 mph (60 km/h) and 124 mph (200 km/h).

The system can intervene in the following situations:

- Active Lane Keeping Assist detects a lane marking.
- One of your front wheels goes over a lane marking.

If you activate the turn signal indicator, a steering intervention does not occur on the corresponding side.

If the system detects an obstacle, such as another vehicle in the adjacent lane, a steering intervention occurs regardless of the turn signal indicator. If you leave the lane without activating the turn signal indicator, but danger of a collision with a moving obstacle is detected in your lane, a steering intervention does not occur.



Display ① will appear in the driver display and a warning tone will sound in the following situations:

- A steering intervention by Active Lane Keeping Assist lasts longer than approximately ten seconds.
- The system carries out two or more steering interventions within approximately three minutes without any steering intervention from the driver.

In the Active Lane Keeping Assist settings, you can set the sensitivity of the system and set the level of support. Additionally, you can set whether the system should react to discontinu-

ous lane markings or only continuous lane markings (→ page 256).

Status displays for Active Lane Keeping Assist



White: Active Lane Keeping Assist is deactivated.



Yellow: there is a malfunction. Please also observe the display messages.



Gray: Active Lane Keeping Assist is activated, but not operating.



Green: Active Lane Keeping Assist is activated and operating. If the system is operational on only one side, the lane marking is shown in green on the corresponding side.



Red: Active Lane Keeping Assist has guided you back into your lane with a course-correcting steering intervention. The status display will flash if there is also a haptic warning in the steering wheel. The lane marking is shown in red only on the side for which there is a warning.

Vehicles without Driving Assistance Package:

if both lane markings are simultaneously shown in red in the status display, Active Lane Keeping Assist has initiated an emergency stop (→ page 235).

Active Lane Change Assist display in the "Assistance" menu



If the front wheel of the vehicle drives over a detected lane marking, this will be highlighted red in the Assistance menu in the driver's display.

- ① **Vehicles with active ambient lighting:** if **Warning Support** is activated, the Active Lane Keeping Assist warning is also accompanied by ambient lighting (→ page 166).

System limits

In the following situations, no lane-correcting steering intervention occurs but rather a warning in the steering wheel, depending on the situation:

- You clearly and actively steer, brake or accelerate.
- If a driving safety system intervenes, such as ESP®, Active Brake Assist or Active Blind Spot Assist.
- You have adopted a sporty driving style with high cornering speeds or high rates of acceleration.
- When ESP® is deactivated.
- If a loss of tire pressure or a faulty tire has been detected and displayed.

The system may be impaired or may not function particularly in the following situations:

- If there is poor visibility, e.g. due to insufficient illumination of the road, if there are highly variable shade conditions or in rain, snow, fog or heavy spray.
- If there is glare, e.g. from oncoming traffic, the sun or reflections.
- If the windshield in the area of the multifunction camera is dirty, or if the camera is fogged up, damaged or covered.
- If there are no lane markings, or several unclear lane markings are present for one lane, e.g. around roadworks.
- If the lane markings are worn, dark or covered.
- If the distance to the vehicle in front is too short and thus the lane markings cannot be detected.
- If the lane markings change quickly, e.g. lanes branch off, cross one another or merge.
- If the road is very narrow and winding.

Observe the notes on driving systems and your responsibility; you may otherwise fail to recognize dangers (→ page 218).

Activating/deactivating Active Lane Keeping Assist

Multimedia system:

- ▶  ▶ Settings ▶ Assistance
- ▶▶ Avoid collision
- ▶▶ Active Lane Keeping Assist

- ▶ Switch the function on or off.

Alternatively, Active Lane Keeping Assist can be activated and deactivated in the Favorites menu.

- ❗ After starting the engine, the settings are country-specific.

Setting Active Lane Keeping Assist

Multimedia system:

- ▶  ▶ Settings ▶ Assistance
- ▶▶ Avoid collision
- ▶▶ Active Lane Keeping Assist

Setting the sensitivity

- ▶ Select .

- ▶ Select **Early**, **Med.** or **Late**.

The last selected setting will be adopted the next time the engine is started.

- ❗ The standard setting for this function is dependent on the country.

Activating or deactivating assistance on discontinuous lane markings

- ▶ Select **Advanced Support**.

The last selected setting will be adopted the next time the engine is started.

- ❗ The standard setting for this function is dependent on the country.
- ❗ This function must be activated in vehicles without Driving Assistance Package, so that Emergency Stop Assist is fully available. Further information on Emergency Stop Assist (→ page 235)

AIRMATIC

Function of AIRMATIC

AIRMATIC is an air suspension system with variable damping for improved driving comfort. The

all-round level control system ensures the best possible suspension and constant ground clearance, even with a laden vehicle. When driving at speed, the vehicle is lowered automatically to improve driving safety and to reduce fuel consumption. You also have the option of manually adjusting the vehicle level.

AIRMATIC includes the following components and functions:

- Air suspension with automatic all-round level control
- Speed-dependent lowering to reduce fuel consumption
- Increased vehicle level for greater ground clearance, selected via the multimedia system
- ADS PLUS (Adaptive Damping System with constant damping force adjustment)

Suspension setting depending on the drive program

Drive program **[S]** and **[S']**:

- The suspension setting is firmer.
- The vehicle is set to low level -1.

- The vehicle is lowered to low level -2 when driving at speeds above 75 mph (120 km/h).
- When driving at speeds below 50 mph (80 km/h), the vehicle is raised again to low level -1.

Drive program **[C]** and **[E]**:

- The suspension setting is comfortable.
- The vehicle is set to the normal level.
- The vehicle is lowered to low level -1 when driving at speeds above 75 mph (120 km/h).
- The vehicle is lowered to low level -2 when driving at speeds above 100 mph (160 km/h).
- When driving at speeds below 75 mph (120 km/h), the vehicle is raised again to low level -1.
- When driving at speeds below 50 mph (80 km/h), the vehicle is raised again to the normal level.

Setting the vehicle level

⚠ WARNING Risk of accident because vehicle level is too high

Driving characteristics may be impaired.

The vehicle can drift outwards, for example, when steering or cornering.

- ▶ Choose a vehicle level which is suited to the driving style and the road surface conditions.

⚠ WARNING Risk of entrapment from vehicle lowering

When lowering the vehicle, people could become trapped if their limbs are between the vehicle body and the tires or underneath the vehicle.

- ▶ Make sure no one is underneath the vehicle or in the immediate vicinity of the wheel arches when the vehicle is being lowered.

⚠ WARNING Risk of becoming trapped due to the vehicle lowering

Vehicles with AIRMATIC or level control: when you unload luggage or leave the vehicle, the vehicle first rises slightly and then returns to the set level shortly afterwards.

You or anyone else in the vicinity of the wheel arches or the underbody could thus become trapped.

The vehicle can also be lowered after being locked.

- ▶ When leaving the vehicle, make sure that nobody is in the vicinity of the wheel arches or the underbody.

! NOTE Damage due to vehicle lowering

Parts of the body could be damaged when the vehicle is lowered.

- ▶ Make sure that there are no obstacles such as curbs underneath or in the immediate vicinity of the body when the vehicle is being lowered.

Requirements:

- The vehicle has been started.
- The vehicle is not moving faster than 37 mph (60 km/h).
- When the trailer socket is contacted (trailer/bicycle rack): the vehicle is not moving faster than 19 mph (30 km/h).

Multimedia system:



Raising the vehicle

- ▶ Select . The indicator lamp lights up continuously. The vehicle is raised to off-road level +1.

Your selection is saved. The off-road level +1 set remains stored even after the ignition has been switched off.

The vehicle is lowered again in the following situations:

- When driving faster than 50 mph (80 km/h).
- When driving briefly between 37 mph (60 km/h) and 50 mph (80 km/h).

- After selecting a different drive program using the DYNAMIC SELECT switch. In this case, the vehicle is adjusted to the height of the active drive program.
- When the trailer socket is contacted (trailer/bicycle rack): the vehicle is moving faster than 19 mph (30 km/h).

Lowering the vehicle

- ▶ Select . The indicator lamp goes out. The vehicle is adjusted to the height of the active drive program.
- ⓘ In the Sport drive program, only the normal vehicle level is possible when the trailer socket is contacted (trailer/bicycle rack).

E-ACTIVE BODY CONTROL

Function of E-ACTIVE BODY CONTROL

E-ACTIVE BODY CONTROL is an electrohydraulic suspension system with variable damping for improved driving comfort. The all-round level control system ensures the best possible sus-

pension and constant ground clearance, even with a laden vehicle. When driving at speed, the vehicle is lowered automatically to improve driving safety and to reduce fuel consumption. The suspension setting is adjusted depending on the road surface, vehicle load and the drive program selected.

The ROAD SURFACE SCAN function detects areas of unevenness in the road before you drive over them by means of a multifunction camera. This reduces chassis movements.

The damping is adjusted individually to each wheel and depends on the following factors:

- Driving style, e.g. sporty
- Road condition, e.g. bumps
- Drive program

E-ACTIVE BODY CONTROL is comprised of the following functions and components:

- **Vehicles with Driving Assistance Package:** ROAD SURFACE SCAN
- Curve inclination function CURVE
- Air suspension with automatic level control

- Speed-dependent lowering to reduce fuel consumption
- ADS PLUS: Adaptive Damping System with constant adjustment of damping characteristics
- DYNAMIC SELECT button for selecting a drive program (→ page 202)
- Manual level adjustment via the multimedia system

Drive program **[S]** and **[S*]**

- The suspension setting is firmer.
- The vehicle is set to low level -1.
- The vehicle is lowered to low level -2 when driving at speeds above approx. 75 mph (120 km/h).
- When driving at speeds below approx. 50 mph (80 km/h), the vehicle is raised again to low level -1.
- ROAD SURFACE SCAN is active.

Drive program **[C]**, **[CV]** and **[E]**

- The suspension setting is comfortable.

- The vehicle is set to the normal level.
- The vehicle is lowered to low level -1 when driving at speeds above 75 mph (120 km/h).
- The vehicle is lowered to low level -2 when driving at speeds above 100 mph (160 km/h).
- When driving at speeds below 75 mph (120 km/h), the vehicle is raised again to low level -1.
- When driving at speeds below 50 mph (80 km/h), the vehicle is raised again to the normal level.
- **[C]** and **[CV]**: ROAD SURFACE SCAN is active.
- **[CV]**: the curve inclination function is active.

i **Operation with a trailer or bicycle rack:** if the electrical connection has been correctly established, the vehicle, irrespective of speed or the drive program selected, is not automatically lowered or raised but rather remains at normal level.

Function of ROAD SURFACE SCAN

 This function is not available in all countries.

The ROAD SURFACE SCAN function monitors the road in front of your vehicle using a multifunction camera (→ page 218). ROAD SURFACE SCAN detects unevenness in the road surface, e.g. bumps, before the vehicle drives over them. Chassis movements are reduced and driving comfort is increased.

ROAD SURFACE SCAN is automatically activated if the following conditions are met:

- Drive program  is not selected.
- No raised vehicle level is set.
- You are driving at a speed between 4 mph (7 km/h) and 112 mph (180 km/h).

System limits

ROAD SURFACE SCAN can be impaired in the following situations or can stop functioning:

- If the road is insufficiently lit, e.g. at night.
- In snow, rain, fog, heavy spray, if there is glare, in direct sunlight or in greatly varying ambient light.

- If the windshield in the area of multifunction camera is dirty, fogged up, damaged or covered.
- If the road surface has no optic structure or reflects light.
- If you are driving too close to the vehicle in front.
- If sections of the route have a very small radius of curvature.
- During abrupt driving maneuver, e.g. heavy braking or sudden acceleration.

Observe the notes on cleaning the multifunction camera (→ page 346).

Setting the vehicle level

 **WARNING** Risk of accident because vehicle level is too high

Driving characteristics may be impaired.

The vehicle can drift outwards, for example, when steering or cornering.

- ▶ Choose a vehicle level which is suited to the driving style and the road surface conditions.

 **WARNING** Risk of entrapment from vehicle lowering

When lowering the vehicle, people could become trapped if their limbs are between the vehicle body and the tires or underneath the vehicle.

- ▶ Make sure no one is underneath the vehicle or in the immediate vicinity of the wheel arches when the vehicle is being lowered.

 **WARNING** Risk of becoming trapped due to the vehicle lowering

Vehicles with AIRMATIC or level control: when you unload luggage or leave the vehicle, the vehicle first rises slightly and then returns to the set level shortly afterwards.

You or anyone else in the vicinity of the wheel arches or the underbody could thus become trapped.

The vehicle can also be lowered after being locked.

- ▶ When leaving the vehicle, make sure that nobody is in the vicinity of the wheel arches or the underbody.

! NOTE Damage due to vehicle lowering

Parts of the body could be damaged when the vehicle is lowered.

- ▶ Make sure that there are no obstacles such as curbs underneath or in the immediate vicinity of the body when the vehicle is being lowered.

Requirements:

- The vehicle has been started.
- The vehicle is not moving faster than 37 mph (60 km/h).

- When the trailer socket is contacted (trailer/bicycle rack): the vehicle is not moving faster than 19 mph (30 km/h).

Multimedia system:



Raising the vehicle

- ▶ Select . The indicator lamp lights up continuously. The vehicle is raised to off-road level +1.

Your selection is saved. The off-road level +1 set remains stored even after the ignition has been switched off.

The vehicle is lowered again in the following situations:

- When driving faster than 50 mph (80 km/h).
- When driving briefly between 37 mph (60 km/h) and 50 mph (80 km/h).
- After selecting a different drive program using the DYNAMIC SELECT switch.

In this case, the vehicle is adjusted to the height of the active drive program.

- When the trailer socket is contacted (trailer/bicycle rack): the vehicle is moving faster than 19 mph (30 km/h).

Lowering the vehicle

- ▶ Select . The indicator lamp goes out. The vehicle is adjusted to the height of the active drive program.
- ⓘ In the Sport drive program, only the normal vehicle level is possible when the trailer socket is contacted (trailer/bicycle rack).

Rear view camera

Function of the rear view camera

The rear view camera monitors the area behind your vehicle. When you engage reverse gear, the image from the rear view camera is automatically shown on the central display.

The rear view camera is only an aid. It is not a substitute for your attention to the surroundings. The responsibility for safe maneuvering and parking remains with you. Make sure that there are no persons, animals or objects etc., in the

262 Driving and parking

maneuvering area while maneuvering and parking.

- i The area behind the vehicle is displayed as a mirror image, as in the inside rearview mirror.

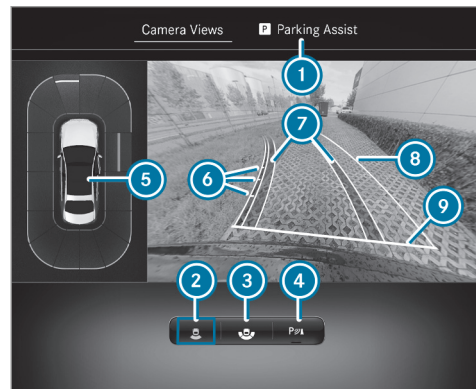

Camera Views menu (top view)

- 1 Parking Assistance menu
- 2 Rear view camera with top view

- 3 Wide-angle view
- 4 Activates/deactivates Parking Assist PARKTRONIC (→ page 271)
- 5 Warning display of Parking Assist PARKTRONIC (→ page 268)
- 6 Guide lines at a distance of approximately 1.6 ft (0.5 m), 3.3 ft (1.0 m), 5 ft (1.5 m) and 9.9 ft (3.0 m) from the rear area
- 7 Path marking the course the tires will take with the current steering wheel angle (dynamic)
- 8 Driven surface depending on the current steering wheel angle (dynamic)
- 9 Guide line at a distance of approximately 1.0 ft (0.3 m) from the rear area
- i When Active Parking Assist is active, lanes 7 are displayed in green (→ page 271).

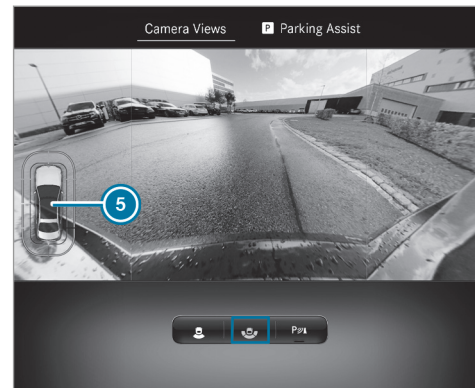

Wide-angle view

System limits

If the system is not ready for operation, the **System Inoperative** message appears on the central display.

The rear view camera will not function or will only partially function in the following situations:

- You are driving forwards at a speed greater than approximately 10 mph (16 km/h).
- The trunk lid is open.
- The weather conditions are poor, e.g. heavy rain, snow, fog, storm or spray.
- The ambient light conditions are poor, e.g. at night or if light is shining into the camera.
- The camera lens is obstructed, dirty or fogged up. Observe the notes on cleaning the rear view camera (→ page 346).
- The camera or rear of your vehicle is damaged. In this case, have the camera and its position and setting checked at a qualified specialist workshop.
- The detection range is limited by additional vehicle attachments at the rear, such as a license plate bracket or bicycle rack.

Also observe the information on vehicle sensors and cameras (→ page 218).

- ⓘ Do not use the rear view camera in these types of situations. You could otherwise

injure others or collide with objects when parking the vehicle.

- ⓘ The contrast of the display may be impaired by direct sunlight or by other light sources, e.g. when driving out of a garage. In this case, pay particular attention.
- ⓘ Have the display repaired or replaced if, for example, pixel errors considerably restrict its use.

360° camera

Function of the surround view camera

The surround view camera is a system that consists of four cameras which cover the immediate surroundings of the vehicle. The cameras assist you when you are parking, for example, or at exits with reduced visibility.

The surround view camera includes the following cameras and evaluates their images:

- Rear view camera
- Front camera
- Two side cameras in the outside mirrors

The cameras are only an aid and may show a distorted view of obstacles, show them incorrectly or not show them at all. They are not a substitute for your attention to the surroundings. The responsibility for safe maneuvering and parking remains with you. Make sure that there are no persons, animals or objects etc., in the maneuvering area while maneuvering and parking.

Menu overview **Camera Views**

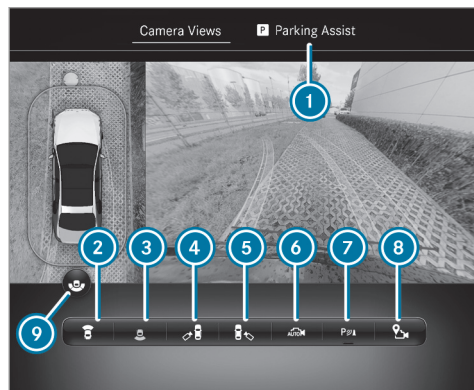

- ① Menu **Parking Assistance**
- ② Top view with image from the front camera
- ③ Top view with image from the rear view camera
- ④ 3D view, left-hand side of the vehicle
- ⑤ 3D view, right-hand side of the vehicle
- ⑥ 3D auto view

- ⑦ To activate/deactivate Parking Assist PARKTRONIC (→ page 271)
- ⑧ To set the GPS activation point (→ page 267)
- ⑨ To switch between standard and wide-angle view
- i In all views, the Parking Assist PARKTRONIC warning display is shown (→ page 268).

Function of the guide lines

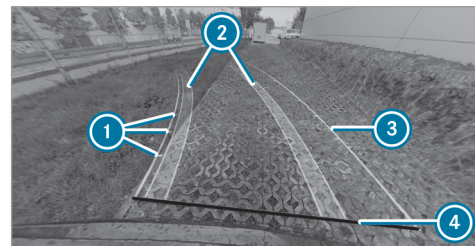

- ① Guide lines at a distance of approximately 1.6 ft (0.5 m), 3.3 ft (1.0 m), 5 ft (1.5 m) and 9.9 ft (3.0 m) from the rear area
- ② Path marking the course the tires will take with the current steering wheel angle (dynamic)
- ③ Driven surface depending on the current steering wheel angle (dynamic)
- ④ Guide line at a distance of approximately 1.0 ft (0.3 m) from the rear area

- ① When Active Parking Assist is active, lanes and guide lines are displayed in green instead of yellow (→ page 271).

Top view with image from the front or rear view camera

If the function is activated, the image from the rear view camera is automatically displayed on the central display when reverse gear is selected.

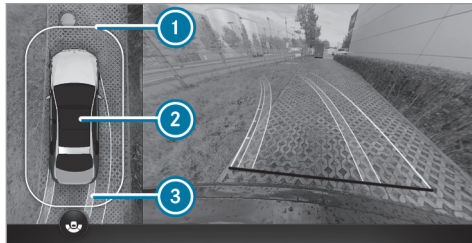

- ① Warning display of Parking Assist PARKTRONIC (→ page 268)
- ② Your vehicle from above
- ③ Lane indicating the route the vehicle will take at the current steering angle

3D view, left/right-hand side of the vehicle

! **NOTE** Risk of accident due to objects being severely distorted in the display or not displayed at all

Due to the projection of the cameras, objects in the 3D views may be severely distorted when displayed or not displayed at all.

- ▶ Make sure that there are no persons, animals or objects etc. in the maneuvering area while maneuvering and parking.



- ① Display of Parking Assist PARKTRONIC (→ page 268)

In the 3D view, left-/right-hand side of the vehicle, the virtual camera moves to the respective side of the vehicle. When you change the transmission position, the view is automatically adapted.

3D auto view

- ① The area behind the vehicle is **not** displayed as a mirror image as is usual in the 3D views.

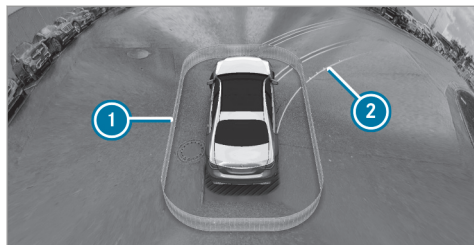

- ① Display of Parking Assist PARKTRONIC (→ page 268)
- ② Guide lines

In the 3D auto view, the virtual camera moves to the standard perspective, facing forward from the rear above the roof. The view changes automatically when approaching obstacles.

If you touch the touchscreen, the view changes to 3D view with free rotation. You can turn, tilt and zoom the views by touch.

Wide-angle view



- ① Display of Parking Assist PARKTRONIC (→ page 268)
- ② To switch between standard and wide-angle view

System limits

If the system is not ready for operation, the **System Inoperative** message appears on the central display.

The surround view camera will not function or will only partially function in the following situations:

- You are driving forwards at a speed greater than approximately 10 mph (16 km/h).
- The doors are open.
- An outside mirror is not completely folded out.
- The trunk lid is open.
- The weather conditions are poor, e.g. heavy rain, snow, fog, storm or spray.
- The ambient light conditions are poor, e.g. at night or if light is shining into the camera.
- The camera lens is obstructed, dirty or fogged up.
- If cameras or vehicle components in which the cameras are installed are damaged. In this event, have the cameras, their positions and their setting checked at a qualified specialist workshop.

- ⓘ Do not use the surround view camera under such circumstances. You could otherwise injure others or collide with objects when parking the vehicle.

For technical reasons, the standard height of the vehicle may be altered if the vehicle is carrying a heavy load and can result in inaccuracies in the guide lines and in the display of the generated images.

The field of vision and other functions of the camera system may be restricted due to additional attachments on the vehicle (e.g. license plate bracket, bicycle rack).

- ⓘ The contrast of the display may be impaired by abrupt, direct sunlight or by other light sources, e.g. when driving out of a garage. In this case, pay particular attention.
- ⓘ Have the display repaired or replaced if, for example, pixel errors considerably restrict its use.

See the notes on cleaning the surround view camera (→ page 346).

Calling up the surround view camera views using the button

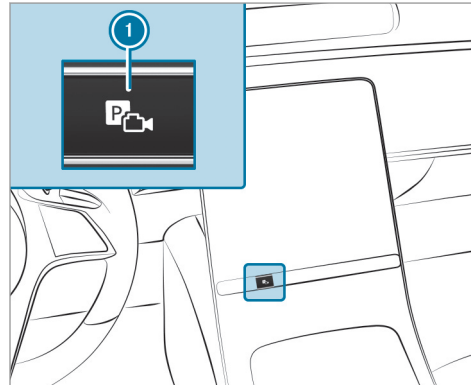

- ▶ Press button ①.
- ▶ Select the **Camera Views** menu.
- ▶ In the multimedia system, select the desired view (→ page 263).

Selecting a view for the surround view camera (reverse gear)

- ▶ Engage reverse gear.
- ▶ Select the desired view in the multimedia system (→ page 263).

Surround view camera with GPS - managing activation positions

Multimedia system:

- ▶ Home ▶ Settings ▶ Assistance ▶ Camera

Renaming an activation position

- ⓘ You can determine activation positions in the **Camera Views** menu. (→ page 263)
- ▶ Select an activation position.
- ▶ Select .
- ▶ Enter a name and confirm. The activation position is saved under the new name.

Deleting an activation position

- ▶ Select **Manage Activation Positions**.
- ▶ Select an activation position.

- ▶ Select .
- ▶ Confirm the prompt.
The activation position is deleted.

Opening the camera cover of the rear view camera

Multimedia system:

- ▶  ▶ Settings ▶ Assistance
- ▶ Camera

- ▶ Select **Open Camera Cover**.

- ⓘ The camera cover closes automatically after some time or after an ignition cycle.

Parking Assist PARKTRONIC

Function of Parking Assist PARKTRONIC

Parking Assist PARKTRONIC is an electronic parking assistance system which monitors the area surrounding your vehicle and shows you the distance between the vehicle and a detected obstacle visually and audibly.

The passive side impact protection also warns you of obstacles to the side. These must be detected beforehand by the sensors in the front

or rear bumper while driving by them. If you steer in the direction of a detected obstacle and there is a risk of a lateral collision, a warning is issued. The passive side impact protection can be activated and deactivated via the multimedia system.

In order for front or rear obstacles to the side to be displayed, the vehicle must first travel a distance of at least half a vehicle length. Once the vehicle has traveled one vehicle length, obstacles on all sides can be shown.

Parking Assist PARKTRONIC is only an aid. It is not a substitute for your attention to the surroundings. The responsibility for safe maneuvering and parking remains with you. Make sure that there are no persons, animals or objects in the maneuvering area while maneuvering and parking in/exiting parking spaces.

Messages on the central display

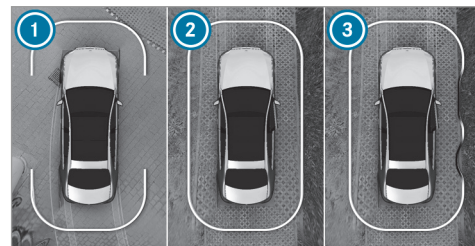

Vehicles with surround view camera

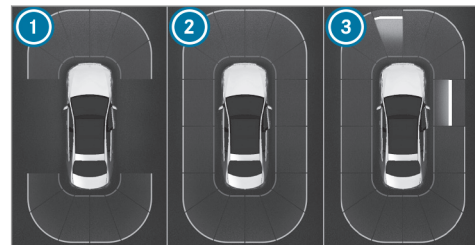

Vehicles with rear view camera

As soon as Parking Assist PARKTRONIC is operational, the respective areas of the display are shown in blue.

- ① Operational, front and rear
- ② Operational, all around
- ③ Operational, all around and obstacle detected

The color of the display changes depending on the distance to the detected obstacle:

- **Blue:** > 3.3 ft (1 m) (no obstacles detected)
- **Yellow:** approx. 3.3 ft (1 m) - 2.2 ft (0.7 m)
- **Orange:** approx. 2.2 ft (0.7 m) - 1.2 ft (0.4 m)
- **Red:** < 1.2 ft (0.4 m)

Vehicles with surround view camera: the boundary line shifts dynamically depending on the position and distance of the obstacles detected.

Depending on the distance to the obstacle detected, an intermittent warning tone also sounds. You can set the timing of the warnings in the multimedia system. In the [Warn Early](#) set-

ting, the system warns you from a distance of 3.3 ft (1 m), in the standard setting only from 1.2 ft (0.4 m).



Vehicles with surround view camera



Vehicles with rear view camera

If you are not in the [Camera & Parking](#) menu and an obstacle in the vehicle path is detected, under the following conditions pop-up window ① appears on the driver display:

- **Vehicles without Active Parking Assist:** when driving no faster than 8 mph (12 km/h).

- **Vehicles with Active Parking Assist:** when driving no faster than 11 mph (18 km/h).

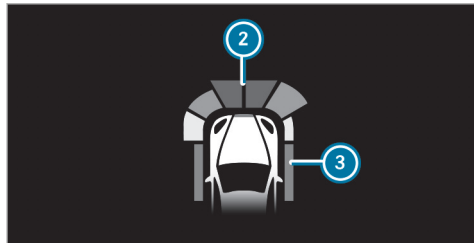

Optionally, obstacles detected by Parking Assist PARKTRONIC from a distance of approximately 3.3 ft (1.0 m) in front ② and 2.2 ft (0.7 m) on sides ③ can also be displayed on the Head-up Display.

System limits

Parking Assist PARKTRONIC does not necessarily take into account the following obstacles:

- Obstacles below the detection range, e.g. persons, animals or objects.
- Obstacles above the detection range, e.g. overhanging loads, overhangs or loading ramps of trucks.
- Pedestrians or animals approaching the vehicle from the side.
- Objects placed next to the vehicle.

Obstacles on the sides are not shown in the following situations, for example:

- You park the vehicle and switch off the ignition.
- You open the doors.

After the engine is restarted, obstacles must be detected again by driving past them before a new warning can be issued.

Also observe the system limits of the following systems:

- Rear view camera (→ page 261)
- Surround view camera (→ page 263)

Observe the information on vehicle sensors and cameras; the system otherwise cannot function properly (→ page 218).

Problems with Parking Assist PARKTRONIC

If the Parking Assist PARKTRONIC display lights up red for approximately three seconds and then goes out, and the  symbol appears on the driver display, Parking Assist PARKTRONIC may have been deactivated due to signal interference. Start the vehicle again and check if Parking Assist PARKTRONIC is working at a different location.

If a warning tone also sounds, it may be due to one of the following causes:

- **The sensors are dirty:** clean the sensors and observe the notes on care of vehicle parts (→ page 346).
- **Parking Assist PARKTRONIC has been deactivated due to a malfunction:** restart the vehicle. If the problem persists, consult a qualified specialist workshop.

Activating/deactivating Parking Assist PARKTRONIC

! **NOTE** Risk of an accident from objects at close range

Parking Assist PARKTRONIC may not detect certain objects at close range.

- ▶ When parking or maneuvering the vehicle, pay particular attention to any objects which are above or below the sensors, e.g. flower pots or drawbars. The vehicle or other objects could otherwise be damaged.

Requirements:

- The camera menu is open.
 - Or: Active Parking Assist is active.
 - Or: the PARKTRONIC pop-up window appears.
- ▶ Tap  in the central display.

If the indicator lamp is lit, Parking Assist PARKTRONIC is active. If the indicator lamp is not lit or the  symbol appears in the instru-

ment cluster, Parking Assist PARKTRONIC is not active.

ⓘ Parking Assist PARKTRONIC is automatically activated when the engine is started.

Alternatively, Parking Assist PARKTRONIC can be activated or deactivated in the quick access menu.

Setting the warning tones of Parking Assist PARKTRONIC

Multimedia system:

→  ▶ Settings ▶ Assistance
▶▶ Parking

Setting the volume or pitch of the warning tones

▶ Set the desired level under [Volume](#) or [Tone Pitch](#).

Activating/deactivating audio fadeout

▶ Activate or deactivate [Audio Fadeout](#). The volume of the currently playing media source is reduced during a Parking Assist PARKTRONIC warning tone.

or

▶ Switch [Audio Fadeout When in R](#) on or off. The volume of the currently playing media source is reduced when reverse gear is engaged.

Setting the time of the warnings

- ▶ Select [Time of Warning](#).
- ▶ Set the time for the warning.

Active Parking Assist

Function of Active Parking Assist

Active Parking Assist is an electronic parking assistance system, which uses ultrasound with the assistance of the rear view camera and surround view camera. When you are driving forwards up to approximately 22 mph (35 km/h), the system automatically measures parking spaces on both sides of the vehicle.

Active Parking Assist offers the following functions:

Vehicles with rear view camera

- Parking in parking spaces parallel to the road



272 Driving and parking

- Backing up into parking spaces perpendicular to the road

Vehicles with surround view camera

- Parking in parking spaces parallel to the road
- Parking in parking spaces perpendicular to the road (optionally either forwards or reverse)
- Parking in parking spaces that can only be detected as such due to markings (for example at the roadside)
- Exiting a parking space parallel to the road
- Exiting a parking space perpendicular to the road (optionally either left or right)

Active Parking Assist is only an aid. It is not a substitute for your attention to the surroundings. The responsibility for safe maneuvering and parking remains with you. Make sure that no persons, animals or objects etc. are in the maneuvering range.



If Active Parking Assist is available, the  message appears on the driver display. When the system detects parking spaces,  appears. The arrows show on which side of the

road free parking spaces are located. These are then shown on the central display.

When Active Parking Assist is activated, the turn signal indicators are activated based on the calculated path of your vehicle. When you are entering or exiting a parking space, the procedure is assisted by acceleration, braking, steering and gear changes.

To start the parking procedure, press the  button (→ page 273).

Active Parking Assist will be canceled in the following situations:

- You deactivate Parking Assist PARKTRONIC.
- You press the  button again.
- You begin steering.
- You engage transmission position .
- ESP® intervenes.
- You open the driver's door.

System limits

If the exterior lighting is malfunctioning, Active Parking Assist is not available.

Also observe the system limits of the following systems:

- Rear view camera (→ page 261)
- Surround view camera (→ page 263)

Objects located above or below the detection range of Active Parking Assist, such as overhanging loads, overhangs or loading ramps of trucks or the borders of parking spaces, are not detected during measurement of the parking space. These are also then not taken into account when calculating the parking procedure. In some circumstances, Active Parking Assist may therefore guide you into the parking space prematurely or brake too late.

Certain environmental conditions, such as snowfall or heavy rain, may lead to a parking space being measured inaccurately. Parking spaces that are partially occupied by trailer drawbars might not be identified as such or be measured incorrectly. Only use Active Parking Assist on level, high-grip ground.

⚠ WARNING Risk of accident due to objects located above or below the detection range of Active Parking Assist

If there are objects above or below the detection range, the following situations may arise:

- Active Parking Assist may steer too early.
- The vehicle may not stop in front of these objects.

This could cause a collision.

▶ In these situations, do not use Active Parking Assist.

Active Parking Assist can also display unsuitable parking spaces, e.g. parking spaces in which parking is not permitted or parking spaces on unsuitable surfaces.

Do not use Active Parking Assist in the following situations:

- In extreme weather conditions such as ice, packed snow or in heavy rain.

- When transporting a load that protrudes beyond the vehicle.
- If the parking space is on a steep downhill or uphill gradient.
- When snow chains are installed.
- Directly after a tire change or when spare tires are installed.
- If the tire pressure is too low or too high.
- If the suspension is out of alignment, e.g. after bottoming out on a curb.
- On steep inclines of more than approximately 15%.

Parking with Active Parking Assist

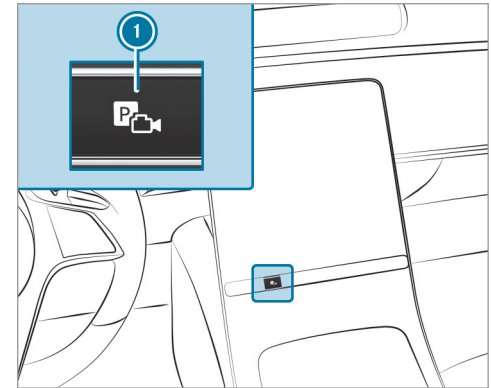

▶ Press button ①.

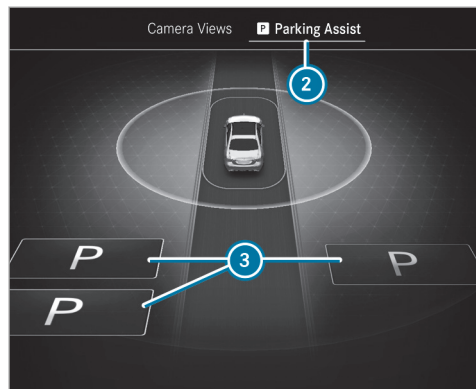

- ▶ Select **Parking Assistance** menu ②.

Parking spaces ③ detected by the system are shown on the central display.

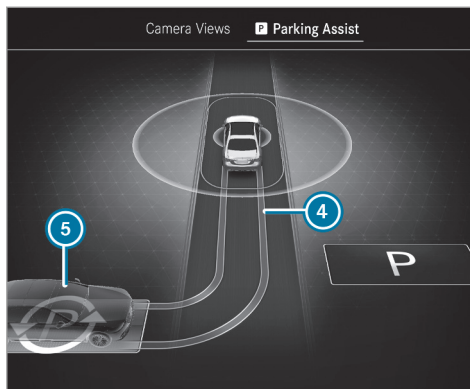

When the vehicle is stationary, indicated vehicle path ④ into currently selected parking space ⑤ also appears.

- ▶ If parking spaces are displayed: bring the vehicle to a standstill.
- ▶ If necessary, select another parking space.

▶ **Vehicles with surround view camera:** to change the parking direction, tap the selected parking space again.

▶ **To start the parking procedure:** press button ① again. The vehicle drives into the selected parking space.

The turn signal indicator is switched on automatically when the parking procedure begins. You are responsible for selecting the turn signal indicator in accordance with the traffic conditions. If necessary, select the turn signal indicator accordingly.

⚠ WARNING Risk of accident due to vehicle swinging out while parking or pulling out of a parking space

While parking or exiting a parking space, the vehicle swings out and can drive onto areas of the oncoming lane.

This could cause you to collide with objects or other road users.

- ▶ Pay attention to objects and other road users.
- ▶ Where necessary, stop the vehicle or cancel the parking procedure with Active Parking Assist.

On completion of the parking procedure, the **Active Parking Assist Finished: Take Control of Vehicle** display message appears.

- ▶ Secure the vehicle against rolling away. When required by legal requirements or local conditions: turn the wheels towards the curb.
- i** You can stop the vehicle and change the transmission position during the parking procedure. The system then calculates a new vehicle path. If no new vehicle path is available, the transmission position can be changed again, or the process can be canceled.

Immediate parking from the camera view



- ▶ Select the **Camera Views** menu.
 - ▶ When the vehicle is stationary and the transmission is position **R**, and the **P** symbol **6** appears in the camera image: press the **P** symbol **6** on the side on which you wish to park. The parking procedure is initiated in the direction selected.
- i** The parking space and parking direction cannot be changed in immediate parking.
- i** This function can be deactivated in the **Parking** menu.

Exiting a parking space with Active Parking Assist

Requirements:

- The vehicle is equipped with a surround view camera.
 - The vehicle has been parked with Active Parking Assist.
- ▶ Start the vehicle.
 - ▶ Press button **1**.

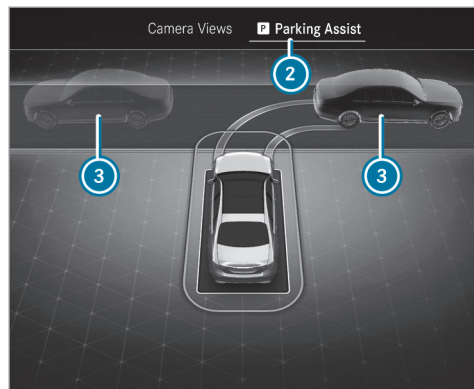

- ▶ Select **Parking Assistance** menu ②.
- ▶ If necessary, change direction of exit ③.
- ▶ **To start exiting the parking space:** press button ① again.
- ▶ If necessary, change the transmission position. Observe any messages displayed on the driver display and central display. The vehicle moves out of the parking space.

The turn signal indicator is automatically switched on when exiting a parking space begins and switched off when it is completed. You are responsible for selecting the turn signal indicator in accordance with the traffic conditions. If necessary, select the turn signal indicator accordingly.

After the parking space has been exited, a warning tone and the  **Active Parking Assist Finished: Take Control of Vehicle** message prompt you to take control of the vehicle. You have to accelerate, brake, steer and change gear yourself again.

If you do not react to the prompt to take control of the vehicle, the system will brake the vehicle to a standstill.

Pausing Active Parking Assist

You can interrupt the parking or exiting procedure of Active Parking Assist by one of the following actions, for example:

- ▶ Depressing the brake pedal
- ▶ Opening the front passenger door, a rear door, the trunk or the hood

- ▶ Applying the electric parking brake or activating the HOLD function

▶ **To resume the parking or exiting procedure:** gently depress the accelerator pedal.

- ① If the electric parking brake was applied before Active Parking Assist was activated, depress the accelerator pedal lightly to start the parking or exiting procedure.

Check the area around your vehicle again before resuming a paused parking procedure. Make sure that persons, animals or objects are no longer in the maneuvering range. Also observe the system limitations of Active Parking Assist.

Automatic braking function of Active Parking Assist

Persons or objects detected in the maneuvering range could cause the vehicle to brake sharply and interrupt the parking or exiting procedure. The vehicle will then be held at a standstill. If you depress the accelerator pedal, the parking or exiting procedure is resumed.

Check the area around your vehicle again before resuming the parking or exiting procedure. Make sure that persons, animals or objects are no longer

ger in the maneuvering range. Also observe the system limitations of Active Parking Assist.

Maneuvering assistance

Function of Drive Away Assist

Drive Away Assist can reduce the severity of an impact when pulling away. If the system detects an obstacle in the direction of travel, the vehicle's speed is briefly reduced to approximately 1 mph (2 km/h).

A risk of collision may arise in the following situations, for example:

- If the driver mixes up the accelerator and brake pedals.
- If the driver engages an incorrect gear.
- If the driver depresses the accelerator pedal with too much force.

Drive Away Assist is active under the following conditions:

- If the vehicle was stationary and the transmission position was changed to **R** or **D**.

- If the vehicle has rolled less than approximately 3.3 ft (1.0 m) since being at a standstill.
- If the detected obstacle is less than approx. 3.3 ft (1.0 m) away.

The **Drive-away Assist** can be deactivated or activated in the **Maneuvering Assistance** menu (→ page 279).

If a critical situation is detected, the following symbol appears in red in the selected view in the **Camera & Parking** menu:



- ⓘ If Drive Away Assist is not available, the same symbol appears in gray. If the **Camera & Parking** menu is not opened on the central display, the symbol and pop-up of Parking Assist PARKTRONIC both appear.

Drive Away Assist is only an aid. It is not a substitute for your attention to the surroundings. The responsibility for safe maneuvering and parking remains with you. Make sure that no

persons, animals or objects etc. are in the maneuvering range.

⚠ WARNING Risk of accident caused by limited detection performance of Drive Away Assist

Drive Away Assist cannot always clearly identify objects and traffic situations.

- ▶ Always pay careful attention to the traffic situation; do not rely on Drive Away Assist alone.
- ▶ Be prepared to brake or swerve as necessary, provided the traffic situation permits and that it is safe to take evasive action.

System limits

The system limits of Active Parking Assist apply (→ page 271).

On uphill gradients, the performance of Drive Away Assist is restricted.

Function of cross traffic warning

The cross traffic warning can warn you of crossing traffic when you are exiting a parking space.

278 Driving and parking

The radar sensors in the bumper also monitor the area adjacent to the vehicle.

The cross traffic warning is active under the following conditions:

- **Warning for Cross Traffic, Rear:** the vehicle is driving in reverse at a speed slower than approx. 6 mph (10 km/h).
- **Warning for Cross Traffic, Front:** the vehicle is driving forwards at a speed slower than approx. 6 mph (10 km/h) and the camera image is shown on the central display (→ page 267).

The **Warning for Cross Traffic, Front** can be deactivated or activated in the **Maneuvering Assistance** menu (→ page 279).

If a critical situation is detected, the following symbol appears in red in the selected view in the **Camera & Parking** menu:



Warning for Cross Traffic, Rear: the vehicle can be automatically braked if cross traffic is detected.

- ① If the cross traffic warning is not available, the  symbol appears in gray. If the **Camera & Parking** menu is not opened on the central display, the symbol and pop-up of Parking Assist PARKTRONIC both appear.

The cross traffic warning is only an aid and not a substitute for your attention to the surroundings. The responsibility for safe maneuvering and parking remains with you. Make sure that no persons, animals or objects etc. are in the maneuvering range.

⚠ WARNING Risk of accident caused by limited detection performance of the cross traffic warning

The cross traffic warning cannot always clearly identify objects and traffic situations.

- ▶ Always pay careful attention to the traffic situation; do not rely on the cross traffic warning alone.

- ▶ Be prepared to brake or swerve as necessary, provided the traffic situation permits and that it is safe to take evasive action.

System limits

The system limits of Active Parking Assist apply (→ page 271).

If the radar sensors are obstructed by vehicles or other objects, detection is not possible.

In the following situations, the cross traffic warning is not available:

- On inclines

Maneuvering brake function

The maneuvering brake function can prevent collisions with pedestrians when the vehicle is backing up at slow speeds. If the rear view camera detects a person in the vehicle path, the vehicle can be braked to a standstill.

The maneuvering brake function can intervene under the following conditions:

- The vehicle is backing up at a speed slower than 6 mph (10 km/h).

- The camera image is shown on the central display (→ page 267).

You can activate and deactivate the maneuvering brake function in the [Maneuvering Assistance](#) menu (→ page 279).

If the maneuvering brake function is triggered, the following symbol appears in red in the selected view in the [Camera & Parking](#) menu:



- i** If the maneuvering brake function is not available, the same symbol appears in gray. If the [Camera & Parking](#) menu is not opened on the central display, the symbol and pop-up of Parking Assist PARKTRONIC both appear.

The maneuvering brake function is only an aid. It is not a substitute for your attention to the surroundings. The responsibility for safe maneuvering and parking remains with you. Make sure that no persons, animals or objects etc. are in the maneuvering range.

⚠ WARNING Risk of accident caused by limited detection by the maneuvering brake function

The maneuvering brake function cannot always clearly detect people. Other obstacles are not detected by the function.

In these cases, the function may brake unnecessarily or not brake at all.

- ▶ Always pay careful attention to the traffic situation; do not rely on the maneuvering brake function alone.
- ▶ Be ready to brake.

System limits

Observe the system limits of the following functions:

- Active Parking Assist (→ page 271)
- Surround view camera (→ page 263)
- Rear view camera (→ page 261)

The maneuvering brake function is not available in the following situations:

- On inclines

Activating/deactivating maneuvering assistance

Multimedia system:

→ ▶ Settings ▶ Assistance
▶ Parking

▶ Select [Maneuvering Assistance](#).

▶ Activate or deactivate the desired maneuvering assistance.

Vehicle towing instructions

The vehicle is not suitable for the use of tow bar systems that are used for flat towing or dinghy towing, for example. Attaching and using tow bar systems can lead to damage on the vehicle.

When you are towing a vehicle with tow bar systems, safe driving characteristics cannot be guaranteed for the towing vehicle or the towed vehicle. The vehicle-trailer combination may swerve from side to side. Comply with the permitted towing methods (→ page 363) and the instructions for towing with both axles on the ground (→ page 364).

Notes on the driver display

⚠ WARNING Risk of accident due to a driver display malfunction

If the driver display has failed or malfunctioned, the function restrictions applying to safety relevant systems are not visible.

The operating safety of your vehicle may be impaired.

- ▶ Drive on carefully.
- ▶ Have the vehicle checked immediately at a qualified specialist workshop.

If the operating safety of your vehicle is impaired, park the vehicle immediately and safety. Contact a qualified specialist workshop.

The driver display shows basic information such as speed, engine speed, fuel level and coolant temperature.

Additional functions available to you include the following:

- Different menus, e.g. for assistance and navigation

- Status displays for the driving systems
- Display messages
- Indicator and warning lamps
- Information on [Consumption](#) and range

The menu contents and settings can be individually adjusted and set.

Notes on the 3D driver display

The 3D driver display enables a spatial representation of the content of the driver display. It is a prerequisite that the driver be recorded by the driver camera.

System limits

The system may be impaired or may not function in the following situations:

- The driver camera is deactivated or is not working.
- The driver is outside the detection range of the driver camera.

- The operating conditions are not in place, e.g. if the outside temperature is too low or too high.

Operating the driver display

⚠ WARNING Risk of distraction from information systems and communications equipment

If you operate information and communication equipment integrated in the vehicle when driving, you will be distracted from the traffic situation. This could also cause you to lose control of the vehicle.

- ▶ Only operate this equipment when the traffic situation permits.
- ▶ If you cannot be sure of this, stop the vehicle whilst paying attention to road and traffic conditions and operate the equipment with the vehicle stationary.

Observe the legal requirements for the country in which you are currently driving when operating the driver display.

Scrolling on the menu bar

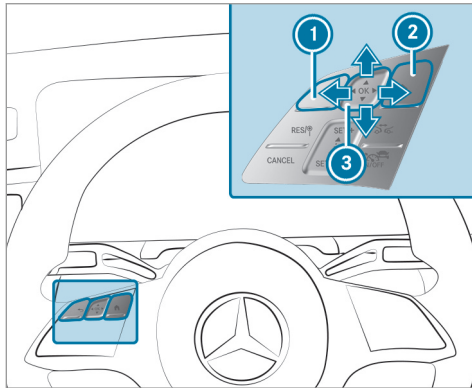

- ① Back button
- ② Main menu button
- ③ Touch Control

The content of the driver display is controlled using the control elements on the left side of the steering wheel. Touch Control ③ is used to navigate in a vertical and horizontal direction by

swiping with one finger. Confirm the selection by pressing the Touch Control.

- ① To operate Touch Control ③ in the most effective way, use the tip of your thumb if possible. You can also set the sensitivity of the Touch Control on the central display .
- ▶ Briefly press main menu button ② .
- ▶ Select a menu by swiping to the left or right on Touch Control ③ .
- ▶ Press Touch Control ③ to confirm.

Menus on the driver display

Notes on the menus on the driver display

⚠ WARNING Risk of distraction from information systems and communications equipment

If you operate information and communication equipment integrated in the vehicle when driving, you will be distracted from the traffic situation. This could also cause you to lose control of the vehicle.

- ▶ Only operate this equipment when the traffic situation permits.
- ▶ If you cannot be sure of this, stop the vehicle whilst paying attention to road and traffic conditions and operate the equipment with the vehicle stationary.

Observe the legal requirements for the country in which you are currently driving when operating the driver display.

The following menus can be called up via the menu bar on the driver display:

- Understated
- Sport
- Exclusive
- Classic
- Navigation
- Assistance
- Service

In some of these menus, you can choose between different display content on the center display area.

282 Driver display

In most of the menus, you can use [Options](#) to configure further settings for the menu-specific display content.

- i** You can find further information about the possible settings and selections on the menus in the Digital Operator's Manual.

Head-up Display

Function of the Head-up Display

The Head-up Display projects various content into the driver's field of vision, for example.

You can use the Head-up Display menu bar to select different contexts, e.g.:

- Minimal
- Sport
- Standard
- Augmented reality
- ECO display
- Settings
- Head-up Display on/off

The following image shows an example of the context with augmented reality.

Head-up Display with navigation and augmented reality (10x5°)

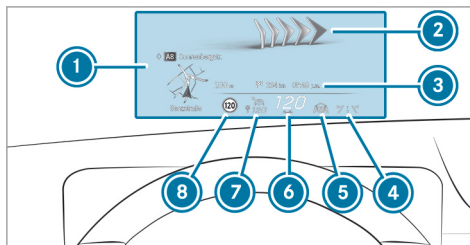

- 1** Navigation instructions
- 2** Augmented reality navigation instructions
- 3** Navigation status displays, such as remaining distance to the destination, expected time of arrival
- 4** Active Lane Keeping Assist status
- 5** Steer Assist status
- 6** Current speed

- 7** Set speed in the driving system (e.g. Active Distance Assist DISTRONIC)
- 8** Detected traffic signs (Traffic Sign Assist)

When you receive a call, the  [Call Waiting](#) message will appear on the Head-up Display and the driver display.

System limits

Visibility is particularly influenced by the following conditions:

- Seat position
- Image position setting
- Ambient light
- Wet road surfaces
- Objects on the display cover
- Polarization in sunglasses

Function of the Head-up Display with augmented reality

- i** Augmented reality is only available in connection with the 10x5° Head-up Display.

The Head-up Display with augmented reality projects content into the driver's field of vision, such as:

- Information from and visualization of the navigation system
- Information and visualization of the driver assistance systems, e.g. Active Distance Assist DISTRONIC
- Information from the menus of the driver display

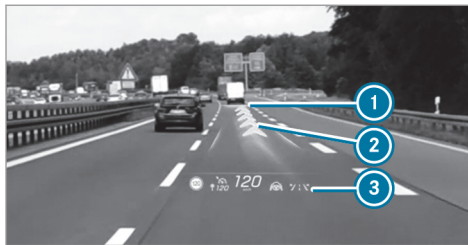

Head-up Display with augmented reality (example)

- 1 Marker of the detected vehicle in front (Active Distance Assist DISTRONIC)
- 2 Change-of-direction arrows for the route (navigation)
- 3 Status line for driver assistance systems

The marker of the detected vehicle in front and the change-of-direction arrows for the route are dynamic displays. The vehicle marker stays with the vehicle in front, and Active Distance Assist regulates your speed based on this. The change-of-direction arrows point the way calculated by the navigation system.

System limits

The marker of the detected vehicle in front may be inaccurate or may not be applied to the correct vehicle in some situations. Always pay attention to the actual driving situation.

Route guidance with augmented reality is not available in some situations, e.g. in the event of poor satellite reception or roads that have not been digitized.

Visibility is influenced by the following conditions:

- Driver camera and multifunction camera recording
- The extent to which the windshield in the area of the multifunction camera is dirty, or if the camera is fogged up, damaged or obscured.

Further system limits of the Head-up Display (→ page 282).

Operating the Head-up Display

Selecting display content of the Head-up Display via the menu bar of the driver display

- ▶ Press the  main menu button on the left.
- ▶ **To select the menu bar of the Head-up Display:** swipe upwards on the left-hand Touch Control.



Switching between display contents on the Head-up Display



- ▶ Swipe right or left on the left-hand Touch Control. The Head-up Display shows a preview of the selected display contents after each swipe.
- ▶ Press the  button to confirm the desired content.

Switching back to the driver display

- ▶ Press the  or  button.

Setting the position and brightness

- ▶ On the menu bar of the Head-up Display, select **Settings** by swiping to the left or right.
- ▶ Press the left-hand Touch Control. The current position and brightness settings will be displayed graphically on the Head-up Display as well as on the driver display.
- ▶ **To adjust the position:** swipe up or down on the left-hand Touch Control.

- ▶ **To adjust the brightness:** swipe to the right or left on the left-hand Touch Control. The settings configured for position and brightness will be saved automatically.
- ▶ Press the  or  button to exit the settings.

i Vehicles with augmented reality function: when the position is adjusted, the status bar will be moved upward and the display area reduced. This may slightly affect the area on which the augmented reality content is displayed.

Selecting the Head-up Display with augmented reality

- ▶ Press the main menu button  on the left.
- ▶ **To select the menu bar of the Head-up Display:** swipe upwards on the left-hand Touch Control.
- ▶ **To select the Head-up Display with augmented reality:** swipe to the left or right on

the left-hand Touch Control to activate the desired content.

Switching the Head-up Display on/off

Driver display:



Switching on

- ▶ Swipe upwards on the left-hand Touch Control. **Head-up Display** will appear.
- ▶ Press **OK** on the left-hand Touch Control.

Switching off

- ▶ Swipe upwards on the left-hand Touch Control.
- ▶ Select **Head-up Display** by swiping on the left-hand Touch Control.
- ▶ Press **OK** on the left-hand Touch Control.

Setting the Head-up Display in the multimedia system

Multimedia system:



Switching the 3D display for the driver display on or off

- ▶ Select **3D Driver Display**.
The 3D display of the driver display is switched on or off.
- ⓘ The 3D display for the driver display is only activated when the driver camera detects the driver. Otherwise, the driver display switches from the 3D display to the 2D display (→ page 280).

Switching the Head-up Display on/off

- ▶ Select **Head-up Display**.
The Head-up Display is activated or deactivated.

Vehicles with a 48 V on-board electrical system (EQ Boost technology)

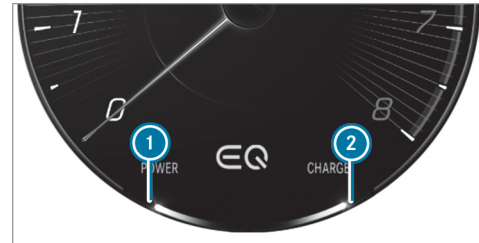

- ① The area shows the electric drive support.
- ② This area shows the recuperation behavior of the electric motor.



READY shows the drive system's operational readiness.





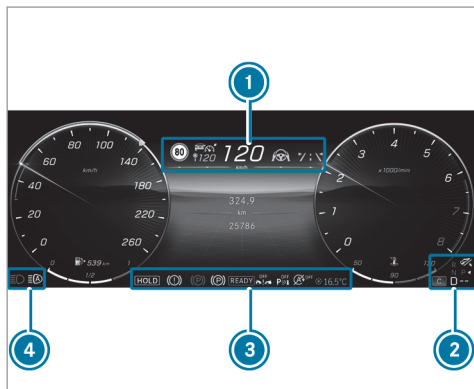







- ⓘ Due to various system limits, the displayed values may temporarily differ slightly from the actual value.

Overview of status displays on the driver display



The status displays for the driving and driving safety systems can be found in areas ① to ④.



-  Pedestrian detection (only on assistant display)
-  Active Parking Assist is available (→ page 273)

-  Active Parking Assist has detected a parking space (→ page 273)
-  Parking Assist PARKTRONIC deactivated (→ page 271)
-  Active Distance Assist DISTRONIC (→ page 226)
-  Specified distance for Active Distance Assist DISTRONIC (→ page 226)
-  Active Brake Assist switched off (→ page 244)
-  Active Brake Assist impaired or not functioning (→ page 244)
-  Active Steering Assist (→ page 233)
-  Active Lane Change Assist (→ page 237)
-  Active Lane Keeping Assist (→ page 254)
-  Active Blind Spot Assist (only on assistant display) (→ page 252)
-  Haptic accelerator pedal (→ page 199)
-  ECO start/stop function (→ page 198)
-  HOLD function (→ page 223)
- Adaptive Highbeam Assist (→ page 161)

Adaptive Highbeam Assist Plus (→ page 163)

-  Active Stop-and-Go Assist (→ page 233)
-  Slippery road surface warning

Vehicles with Traffic Sign Assist: Detected instructions and traffic signs (→ page 244)

Overview and operation

Notes on the MBUX multimedia system

⚠ WARNING Risk of distraction from information systems and communications equipment

If you operate information and communication equipment integrated in the vehicle when driving, you will be distracted from the traffic situation. This could also cause you to lose control of the vehicle.

- ▶ Only operate this equipment when the traffic situation permits.
- ▶ If you cannot be sure of this, stop the vehicle whilst paying attention to road and traffic conditions and operate the equipment with the vehicle stationary.

You must observe the legal requirements for the country in which you are currently driving when operating the multimedia system.

! NOTE Increased surface temperature due to direct sunlight on the central display





The surface of the central display is very dark.

If the display is exposed to direct sunlight, the surface can become very hot.

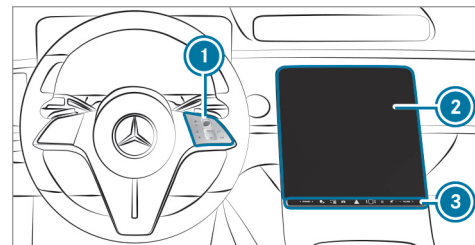
- ▶ If the central display has been exposed to direct sunlight, allow it to cool down before touching it for a long time.

Overview of the MBUX multimedia system



- ① Touch Control and control panel for the MBUX multimedia system
MBUX stands for Mercedes-Benz User Experience.
 - Operating Touch Control
- ② Central display with touch functionality
 - Home screen overview
 - Operating the touchscreen
- ③ Control panel with fingerprint sensor , switches the MBUX multimedia system on or off , switches the mute function on or off  and adjusts the volume 

Further operating options:

- Conducting a dialog with the MBUX Voice Assistant.
 - Operating functions contact-free with the MBUX Interior Assistant.
The interaction then follows intelligently, reactively or with hand or head movements.
 - If the vehicle is equipped with a driver camera, functions can be triggered via "Look & Answer".
- i** You can find further information about operation as well as about applications and services in the Digital Operator's Manual.

Anti-theft protection

This device is equipped with technical provisions to protect it against theft. Further information on protection against theft can be obtained at an authorized Mercedes-Benz Center.

Home screen overview

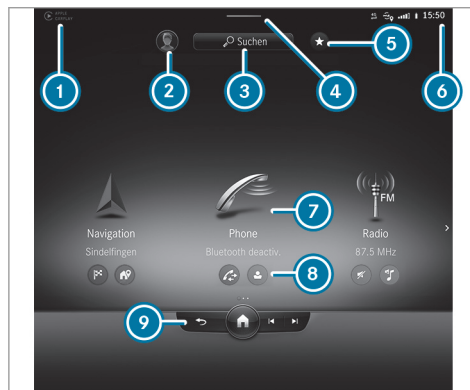

- 1 Status line
- 2 Calls up user profile settings and switches user
- 3 Uses the global search
- 4 Calls up the Control Center (pull down)
- 5 Calls up favorites
- 6 Displays in the status line

- 7 Calls up applications
- 8 Quick-access to application
- 9 Global menu

- Calls up previous menu
- Calls up the home screen
- Previous track or previous radio station
- Next track or next radio station
- Active call: display of the call duration

In the image, the applications are arranged as a carousel. Pressing and holding on arranges the applications in a grid. This presentation is also used by a smartphone, for example.

The following functions are called up in the Control Center:

- Notifications Center
- Content sharing menu
- Favorites
- Vehicle quick-access

Content sharing menu

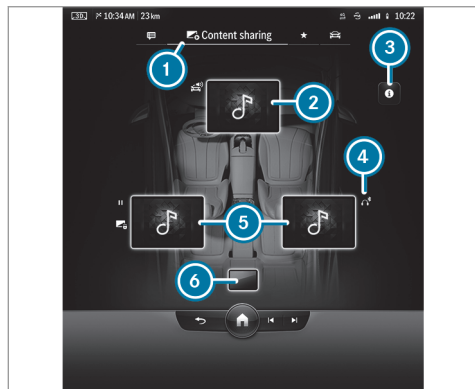

Example: showing displays

- ① Calls up a menu
- ② Central display with active content (cover display)
- ③ Displays animation for content sharing
- ④  Bluetooth® headphones connected to the right rear display

- ⑤ Rear displays with active content (cover display)
- ⑥ MBUX rear tablet

To share content, drag a display and drop it over another display.

To control media playback, tap a display.

Operating the MBUX multimedia system

Using Touch Control

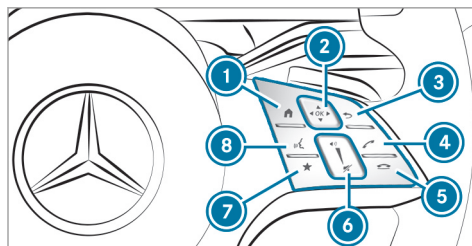

- ①  Shows the home screen
- ② Touch Control

    swipe in the direction of the arrow (navigate)

 Press (confirm)

③  Returns to the previous display

④  Makes or accepts a call

⑤  Rejects or ends a call

⑥ Increase volume: swipe upwards

Reduce volume: swipe down

 Switch off the sound: press

⑦  Calls up favourites (press briefly) or adds favourites (press and hold)

⑧  Starts the MBUX Voice Assistant

You can navigate through menus and lists via the touch-sensitive surface of Touch Control ② using a **single-finger swipe**, for example:

▶ **To enter a character:** select a character using the keyboard and press on Touch Control ②.

▶ **To select a menu option:** scroll in a list and press Touch Control ②.

▶ **To move the digital map:** swipe in any direction.

Using the touchscreen

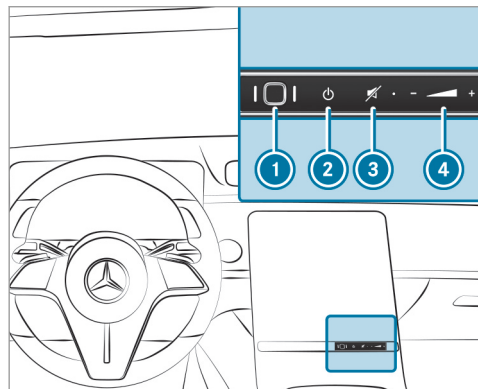

- ① Fingerprint sensor
- ② Switches the MBUX multimedia system on or off
- ③ Switches the mute function on/off
- ④ To adjust the volume
Press or or swipe over the button

- ▶ **To select a menu item or entry:** tap on a symbol or an entry.
- ▶ **To increase the map scale:** tap twice quickly with one finger.
- ▶ **To reduce the map scale:** tap with two fingers.
- ▶ **To enter characters with the keypad:** tap on a button.
- ▶ **To navigate in menus:** swipe up, down, left or right.
- ▶ **To use handwriting to enter characters:** write the character with one finger on the touchscreen.
- ▶ **To zoom in and out of the map:** move two fingers together or apart.
- ▶ **To enlarge or reduce the size of a section of a website:** move two fingers together or apart.
- ▶ **To turn the digital map:** turn counter-clockwise or clockwise using two fingers.

- ▶ **To move the digital map:** touch the touchscreen and move your finger in any direction.
- ▶ **To save the destination in the digital map:** touch the touchscreen and hold until a message is shown.
- ▶ **To call up the home screen:** swipe up with three fingers in an application.
- ▶ **To set the volume on a scale:** touch the touchscreen and move the finger to the left or right.
- ▶ **To call up a global menu in the applications:** touch the touchscreen and hold until the **Options** menu appears.

Function of the MBUX Voice Assistant

- ⚠ **WARNING** Risk of distraction from information systems and communications equipment

If you operate information and communication equipment integrated in the vehicle

when driving, you will be distracted from the traffic situation. This could also cause you to lose control of the vehicle.

- ▶ Only operate this equipment when the traffic situation permits.
- ▶ If you cannot be sure of this, stop the vehicle whilst paying attention to road and traffic conditions and operate the equipment with the vehicle stationary.

For your own safety, always observe the following points when operating mobile communications equipment and especially your voice control system:

- Observe the legal requirements for the country in which you are driving.
- If you use the voice control system in an emergency your voice can change and your telephone call, e.g. an emergency call, can thereby be unnecessarily delayed.
- Familiarize yourself with the voice control system functions before starting the journey.

Using the MBUX Voice Assistant, vehicle functions and various areas of the MBUX multimedia

system can be operated by voice input. The MBUX Voice Assistant is operational approximately half a minute after switching on the ignition and can be operated from all seats. Further information and examples of voice commands can be found in the Digital Operator's Manual.

You can use the MBUX Voice Assistant to operate the following functions depending on the vehicle equipment:

- Telephone
- Text message and e-mail
- Navigation
- Radio, media, TV
- Vehicle functions
- Online functions

Full functionality of the voice control system is only available for you with activation of online voice control.

Conducting a dialog

Starting a dialog

- ▶ Say "Hey Mercedes" to activate the MBUX Voice Assistant. Voice activation must be switched on in the multimedia system.

or

- ▶ Press the  button on the multifunction steering wheel. A blue line appears in the MBUX multimedia system. The dialog can be started.

For the dialog with the MBUX Voice Assistant, you can use complete sentences of colloquial language as voice commands. Voice activation can also be directly combined with a voice command, e.g. "Hey Mercedes, how fast can I drive?".

Calling up help

- ▶ **For information about the MBUX Voice Assistant:** say "Hey Mercedes, what can you do?"
- ▶ **Digital Operator's Manual:** "Show me the Operator's Manual". The full extent of the

Digital Operator's Manual is available when the vehicle is stationary.

Operating functions (examples)

- ▶ **To operate the navigation:** "Search for an Asian restaurant, but not Japanese, in South London."
- ▶ **To operate the phone:** "Call my father."
- ▶ **To change the system language to English (short command):** "Change language to English".
- ▶ **To operate the radio:** "Show me the list of radio stations."
- ▶ **To operate media:** "Switch on random playback."
- ▶ **To operate vehicle functions:** "Switch the seat heating to level 2."
- ▶ **To operate online functions:** "What's the time in Sydney?"
- ▶ **To ask a question about the vehicle:** "Do I have Blind Spot Assist?"

Overview of the MBUX Interior Assistant

⚠ WARNING Risk of injury from the camera's laser radiation

This product uses a classification 1 laser system. If the housing is opened or damaged, laser radiation may damage your retina.

- ▶ Do not open the housing.
- ▶ Always have maintenance work and repairs carried out by a qualified specialist workshop.

This product complies with the requirements of the FDA 21 CFR 1040.10 and 1040.11 with exception of the variations according to the FDA Laser Notice No. 50 from 24. June 2007.

- ⓘ The camera records image data for the applications, for example body, head and hand detection. The camera converts the image data directly into meta data. No image data is saved in the process. The data is only processed in the vehicle and is not transmitted from the vehicle.

- ⓘ You can activate or deactivate Interior Assistant functions, e.g. [Light](#). The settings are saved in your current user profile and are seat-specific. Via the user profile they are also available in another vehicle with the MBUX Interior Assistant. This means that you only have to make the settings once and can take them with you to the other vehicle.
- ⓘ You can switch the Interior Assistant front and rear camera on and off using [Front](#) and [Rear](#). The selected camera settings (on/off) are not saved in the user profile and only apply to the current vehicle. If you change to another vehicle with the MBUX Interior Assistant, please check the settings and adjust them if necessary.

The MBUX Interior Assistant is equipped with front and rear cameras.

- ⓘ Alternatively, a configuration with front camera only is also available.

The front camera consists of two cameras that support the driver and the front passenger.

The rear camera consists of two cameras that support the left and right rear seat passengers.

The MBUX Interior Assistant records the vehicle occupants via 3D laser cameras. The cameras of the front camera are located in the overhead control panel. The cameras of the rear camera are located in the roof bows.

The Assistant detects interactions of the vehicle occupants via the cameras. It interprets the natural hand, head and body movements of the vehicle occupants either in context or at their explicit request. The Assistant can thus automatically trigger vehicle interior functions and assist appropriately to the situation.

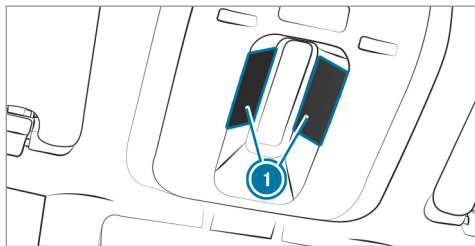

① Arrangement of the cameras of the front camera in the overhead control panel

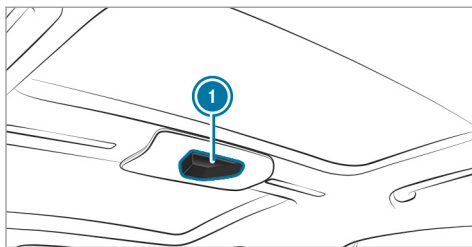

① Arrangement of the rear camera in the roof bows

The Assistant supports vehicle and infotainment functions at three interaction levels:

- INTELLIGENT
The Assistant recognizes vehicle occupants automatically and activates functions.
- REACTIVE
The Assistant recognizes the natural body language of a vehicle occupant and carries out functions automatically, appropriate to the situation.
- CONTACTLESS

The vehicle occupant actively requests a function using a hand movement or pose.

The Assistant offers functions for the following:

- SAFETY
The Assistant supports vehicle occupants with the use of restraint systems.
- COMFORT
The Assistant enhances comfort by automating functions inside the vehicle and supporting natural interaction with the vehicle.
- INFOTAINMENT
Operating options or information are highlighted and/or shown on the central display as your hand approaches. The vehicle occupants can carry out a favorite function with a hand pose.

System limits, display messages and notes for rectification

The error messages are shown on the central display, for example.

The system may be impaired or may not function in the following situations:

- The cameras may heat up during operation. As a result the cameras may switch off temporarily, particularly during longer periods of operation and at high outside temperatures.

Do not touch or cover the cameras and wait until the cameras have cooled down and are available again.

The [Interior Assistant Unavailable Further Information to Follow](#) message appears.

You receive a message when the camera is available again.

- Front or rear camera is covered or dirty, fogged up or scratched.

Wait until the camera has cooled down before cleaning the camera cover.

The [Currently Unavailable See Operator's Manual](#) message appears.

Clean the outside of the camera cover with a dry or damp cotton cloth. Do not use microfiber cloths. Do **not** remove the cover when cleaning.

- A vehicle occupant is very large. Clothing being worn (gloves, hat, scarf, color of clothing) or objects carried on a person, for example a watch with a large face, are affecting the camera view. Or the detection range of the camera is restricted.

The [Interior Assistant availability for the driver is limited](#), see [Operator's Manual](#) message appears.

Keep the camera's field of vision clear.

Objects in the detection area of the camera can restrict the camera view. Please make sure, that e.g. no objects hang on the inside rearview mirror.

- The MBUX Interior Assistant is faulty.

The [Interior Assistant Not Available. Please contact your Mercedes-Benz dealer](#). message appears.

Consult an authorized Mercedes-Benz Center.

- Vehicles with rear bench seat: as soon as the center rear seat is occupied, the rear seat functions are not supported.

The [Interior Assistant in rear compartment only available when center seat is vacant](#) message appears.

To use the Interior Assistant in the rear passenger compartment, keep the center rear seat free.

Anticipatory exit warning (SAFETY/reactive)

Requirements:

- The vehicle is equipped with Active Blind Spot Assist with exit warning.
 - Active Blind Spot Assist is activated (→ page 254).
 - The vehicle is equipped with active ambient lighting or ambient lighting.
 - The cameras are switched on:
The front camera activates the front doors.
The rear camera activates the rear doors.
- ⓘ Observe the information on the system limits of Active Blind Spot Assist with exit warning (→ page 250).

The function can warn vehicle occupants about a possible collision with an approaching vehicle or bicycle when they exit the vehicle.

As soon as a vehicle occupant moves their hand towards the door handle, depending on the vehicle equipment, the following warnings are issued:

- The active ambient lighting or ambient lighting flashes red.
- The warning lamp in the outside mirror also flashes red for one of the front doors.
- When the door is opened, a warning tone sounds.

- **i** The visual warning is thus already given **before** the door is opened.
- **i** Further information on Active Blind Spot Assist with exit warning (→ page 250) and on ambient lighting (→ page 166).

Switching the reading light and search light and on or off

Requirements:

- **For the reading light:** the cameras are switched on:
The front camera activates the reading light for driver and front passenger.
The rear camera activates the reading light for the left and right rear seat passengers.
- The driver's and front passenger's hand movement takes place under the inside rear-view mirror. Rear passengers move their hand at the grab handle in front of the reading lamp.
- **For the search light:** the function is available in the vehicle when it is dark.
The cameras are switched on:
The front camera records the interaction area of the unoccupied front passenger seat.
The rear camera records the interaction area of the unoccupied left or right rear seat.

- The seats covered are unoccupied or a child is sitting in a child restraint system.

Switching the reading light on and off



Carrying out operation of the reading light for the driver and front passenger

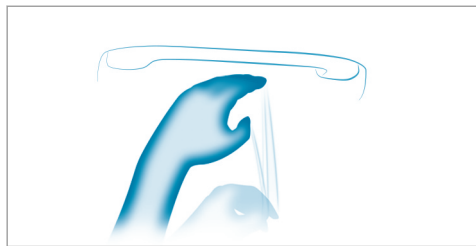

Carrying out operation of the reading light for rear occupants

- ▶ Move your hand up and down vertically under the inside review mirror.
- or
- ▶ Move the hand on the grab handle vertically up and down in front of the reading light. The reading light is switched on or off.

Switching the search light on and off

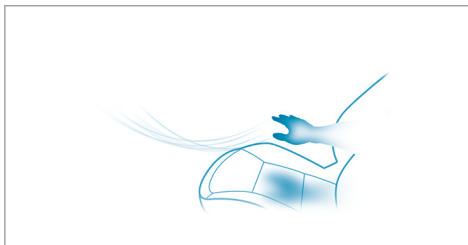

Interaction area for activating the search light

- ▶ **To switch on:** reach with your hand into the area of an unoccupied seat. The search light is switched on automatically for the vehicle occupants.
- ▶ **To switch off:** withdraw the hand from the area of the unoccupied seat. The search light is switched off again.

Automatic preselection of the outside mirror (COMFORT/reactive)

Requirements:

- The front camera is switched on.

Until now, to set the outside mirror the desired mirror had to be selected using a preselection button in the driver's door.

With the MBUX Interior Assistant, the mirror to be set is preselected automatically by the natural movement of your head to the left or right. When the hand touches the button for adjusting the outside mirror, the LED under the button of the preselected mirror side lights up.

Use the button to set the position of the active outside mirror.

- ❶ Preselection of the outside mirror using buttons is still possible. Further information on adjusting the outside mirrors (→ page 171).
- ❶ The driver camera is also used for this application.

Calling up favorites with the V pose (INFOTAINMENT/contactless)

Requirements:

- The front camera is switched on.
- At least one favorite has been saved in the favorites list.
- The favorite has been connected with the MBUX Interior Assistant.
- The area for detecting the favorites pose (V pose) is above the center console in front of the central display.
- The V pose is held for a brief time.

The V pose makes it easier to call up favorites.

The front vehicle occupants can associate their own favorite with the V-pose. Some examples include a navigation destination, a radio station or a massage program for a seat.

- ① If a favorite has not yet been saved and connected with the MBUX Interior Assistant, the multimedia system will assist you.

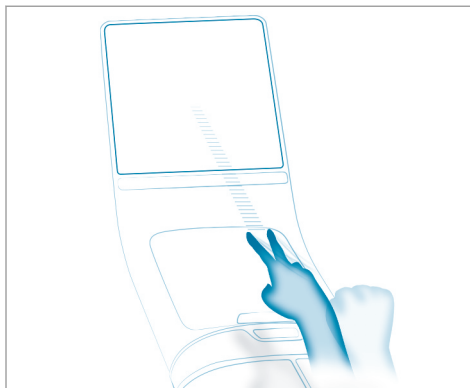

Implementation of the V-pose above the storage compartment of the center console at the height of the central display

- ▶ Position your hand above the storage compartment of the center console at the height of the central display. The back of your hand is facing upwards. In doing so, your index and middle finger are spread to form a V.

With your other fingers bent inwards. Briefly hold the V pose.
The favorite is called up.

Function of the driver camera

The driver camera is in the driver's display or in the 3D driver display.

The driver camera detects the following characteristics:

- Head position
- Viewing direction
- Eyelid closure characteristics
- Driver's face

- ① The driver camera records image data for applications such as ATTENTION ASSIST and facial recognition, for example. The camera converts the image data directly into meta data. No image data is saved in the process. The data is only processed in the vehicle and is not transmitted from the vehicle. The camera is activated automatically each time the engine is started.

The driver camera must be set up for face detection before use. Teaching-in biometric data (→ page 300).

System limits

The system may be impaired or may not function in the following situations:

- The camera is covered or dirty, fogged up or scratched.
- The driver's face and/or eyes are covered.
- The driver is wearing glasses that block infrared.

Display messages

In the following situations display messages may be shown:

- The driver camera is inoperative.
The camera is faulty.
The [Driver Camera Inoperative See Operator's Manual](#) message appears.
- The driver camera cannot capture the position of your head.

The [Change the steering wheel/ seat position until 6 dots are visible on the upper edge of the screen.](#) message appears.

- The view of the driver camera is reduced or restricted.

The [Driver Camera View Currently Restricted See Operator's Manual](#) message appears.

Notes on care

Please comply with the notes on caring for the interior (→ page 348).

Switching the driver camera on or off

Multimedia system:

- ➔  ➔ Settings ➔ System
- ➔ Intelligent Assistance
- ➔ Select On or Off.

When the driver camera is switched off, the following functions are not available or limited:

- The 3D driver display (→ page 280)
- The MBUX augmented reality Head-up Display (→ page 282)

- The microsleep detection of ATTENTION ASSIST (→ page 224)

- The facial recognition

This function serves as sensor input for authentication and unlocking of the user profile and protected applications (→ page 300).

- Multimodality

This function activates the MBUX Voice Assistant with eye control, e.g. for the confirmation of a display message by voice.

Information on users, suggestions and favorites

⚠ WARNING Risk of becoming trapped during adjustment of the driver's seat after calling up a driver profile

Selecting a user profile may trigger an adjustment of the driver's seat to the position saved under the user profile. You or other vehicle occupants could be injured in the process.

- ▶ Make sure that when the position of driver's seat is being adjusted using the multimedia system, no people or body parts are in the seat's range of movement.

If there is a risk of someone becoming trapped, stop the adjustment process immediately:

- ▶ a) Tap the warning message on the central display.
- or
- ▶ b) Press a memory position button or a seat adjustment switch on the driver's door.
The adjustment process will be stopped.

The driver's seat is equipped with an access preventer.

If the driver's door is open, the driver's seat will **not** be set after calling up the driver's profile.

User profiles and user-specific content

Prerequisites for the vehicle owner:

- You have a Mercedes me user account.
 - You have a Mercedes me PIN.
 - You have agreed to the terms of use.
 - The vehicle is linked to a Mercedes me user account.
- ⓘ If one of the pre-requisites listed is missing or if no user profile has been selected, the data described in the following section will be saved in the vehicle as the standard setting. Standard settings can be changed by all vehicle users.

User profiles save personal settings. If the vehicle is used by several people, a person can change their profile settings without changing the settings of other users.

You can individualize a user profile in the vehicle using the set-up assistant or using the settings in your user profile. Some settings, e.g. the Mercedes me PIN and a profile photo are made in the Mercedes me app or in the Mercedes me Portal.

User-specific content and applications with personal data are protected by different levels of security. To access protected content, the Mercedes me PIN and, depending on the vehicle equipment, biometric sensors can be used.

- ⓘ The security level is set by the multimedia system and calculated from the combination of all sensor inputs. Some security levels cannot be turned off.
- ⓘ When a user profile is activated, the following personalized comfort systems, for example, can be adjusted or their settings loaded:
 - Seat
 - Ambient light
 - Outside mirrors
 - Blinds
 - Air conditioning adjustment

If the user profile is activated when driving then the driver's seat position will not be adjusted.

Depending on the vehicle equipment you can, as a user, save the following settings, for example:

- Driver's seat, steering wheel and mirror settings
- Climate control
- Ambient lighting
- Radio (including station list)
- Suggestions and favorites

Suggestions

The vehicle can learn the habits of the driver. It then makes suggestions regarding navigation destinations, phone numbers and music preferences. The requirements for that are the selection of a user, your consent to the recording of data and sufficient collected data.

Favorites

Favorites offer you quick access to frequently used applications. 100 favorites are available in total.

Configuring users, suggestions and favorites

Requirements:

- To use the set-up assistant: the vehicle is stationary.

Multimedia system:



Adding a user

- ▶ Select **+** Add User .
A QR code is loaded.
- ▶ Scan the displayed QR code with the Mercedes me app or any QR code scanner on a mobile device. If the Mercedes me app is not yet installed on your mobile device, you will be directed to the store of your mobile device.
- ▶ Follow the directions in the app.
The vehicle is connected with your Mercedes me user account. This automatically creates your user profile in the vehicle.
If only your user profile is available, it will be loaded automatically.

If more than one user profile is available, you will be directed to the user selection.

When the vehicle is stationary, the set-up assistant starts automatically after user selection.

Selecting user options

- ▶ Select **Settings**.
- ▶ Select **Suggestions**.
- ▶ Select **Allow All Suggestions**.

or

- ▶ Switch the options on or off individually.
If an option is switched on and sufficient data has been gathered, suggestions based on your user behavior will be offered to you.
- ▶ **For intelligent multimodality:** select **Multimodality**.
If the option is active, the MBUX Voice Assistant can be activated in certain situations.
- ▶ **To switch the learning function off for 24 h:** switch on **Deactivate 24h Intelligent Learning**.

- ▶ **To delete cumulated suggestions:** select **Reset Suggestion History** and confirm **Ja** (Yes).

Protecting user-specific content and applications

If you add a new user, access protection is already activated for the user profile. The Mercedes me PIN and, depending on the vehicle equipment, biometric sensors are available for access. Biometric sensors must be taught in in the vehicle. The authentication process then takes all taught-in and available sensors into account.

The following user-specific content and applications are protected, for example:

- User selection and user profile settings
- Biometric sensors
 - The teaching-in of biometric sensors is protected.
- Suggestions
 - The data and determination of the most probable navigation destinations, media

sources, radio stations, contacts and messages are protected.

- **ENERGIZING COACH**
 - The recorded health data and their evaluation are protected.
- **Mercedes me connect store**
 - The purchase of services is protected.
- ▶ Switch **Protect Content** on or off.
- ▶ Switch **Access Protection** on or off.
- ⓘ When access protection is switched off, your user profile can be accessed and changed from every vehicle seat.
- ⓘ Access protection is switched on or off on a vehicle-specific basis.

Teaching in, editing and deleting biometric data

The biometric data models are saved in the sensors in the vehicle. If recognition has been taught-in, this sensor serves as a contributory factor for authentication on the multimedia system.

- ▶ Select **Protect Content**.

- ▶ Select **Facial Recognition**, **Fingerprint Recognition** or **Voice Recognition**.

- ⓘ If necessary, authenticate yourself on the multimedia system.

- ▶ **To use face recognition:** close the driver's door or fasten the driver's seat belt.

- ▶ Look at the driver display for about five seconds.

Your face is scanned. A message in the driver display shows whether facial recognition was successful or not. You can unlock your user profile and protected applications with the facial scan.

- ▶ **To use fingerprint:** place and lift your finger several times on the fingerprint sensor under the touchscreen .

The finger is scanned. If the scanning procedure is successful, a message appears on the central display. You can unlock your user profile and protected applications with your fingerprint.

- ▶ **To use voice recognition:** speak the sentence shown on the central display and follow the instructions of the voice assistant. If the voice recognition was successful, a message appears on the central display. You can unlock your user profile and protected applications with voice input.

ⓘ Avoid background or disturbing noises during voice recognition.

- ▶ **To delete biometric data:** select [Delete](#).
- ▶ Select [Ja](#) (Yes).

Selecting a user

- ⓘ When you call up your driver profile, the driver's seat and the steering wheel can be set. You can cancel the setting process with the following actions:
 - Tap on the [Tap Here to Cancel](#) message in the central display.
 - Press one of the seat operating buttons in the driver's door.
- ▶ Select [Change User](#).
- ▶ Select a user.

- ▶ When requested to do so, authenticate with the Mercedes me PIN or a taught-in biometric characteristic.
The user profile is loaded and activated.

ⓘ If you select [Continue Without Selecting a User](#), no specific settings for the user profile are loaded.

Adding favorites from categories

- ▶ Select .
- ▶ Select .
- ▶ Select .
- ▶ Select  [Create New Favorite](#).
- ▶ Select the category.
- ▶ Select a favorite.

Linking favorites with the MBUX Interior Assistant V pose

- ▶ Select .
- ▶ Select .
- ▶ Select .
- ▶ Select [Driver](#) or [Passenger](#).

- ▶ Select the category.
- ▶ Select a favorite.

System settings

Overview of the system settings menu

In the system settings menu, you can make settings in the following menus and control elements:

- Display:
 - Display brightness
- Control elements:
 - Keyboard language and handwriting recognition
 - Touchpad sensitivity
 - Sensitivity of the Touch Controls
 - Haptic operation for the touchscreen
- MBUX Voice Assistant
- MBUX Interior Assistant
- Sound:
 - Entertainment

- Navigation and traffic announcements
- Telephone
- Voice amplification
- Connectivity:
 - Wi-Fi, Bluetooth, NFC
- MBUX rear tablet child-proof lock
- Time & date
- Language
- Units for distance
- System PIN
- Updating software
- System Reset

Overview of software updates

Important software updates may be necessary for the security of your multimedia system's data. Install these updates, or else the security of your multimedia system cannot be ensured.

The multimedia system displays a corresponding message when a software update is available.

If the [Automatic Online Update](#) option is active, software updates are downloaded automatically. If the option is deactivated, you will be informed of new software updates once. The software updates are available for downloading for a limited period of time.

Carrying out a software update:

- You can start online software updates via the communication module.
 - You can start software updates via a Wi-Fi hotspot.
 - You can start map updates from an external medium.
- ⓘ Online software updates cannot be performed via external Wi-Fi hotspots that are encrypted using TKIP.
 - ⓘ To complete software updates via the communication module, the vehicle must be connected with the Internet and a Mercedes me user account.
 - ⓘ To complete software updates via Wi-Fi, the vehicle must be connected to an external Wi-Fi hotspot.

A software update consists of three steps:

- Downloading or copying of the data required for installation
 - Installation of the downloaded software update
 - Activation of the downloaded software update.
- ⓘ It may be necessary to restart the MBUX multimedia system after completion of a software update.
 - ⓘ While some software updates are being downloaded, the multimedia system cannot be operated and the vehicle functions may be restricted.
 - ⓘ Some software updates require a safe vehicle status for the installation to be completed. They may only be carried out in a safely parked vehicle with the ignition switched off.

For software updates requiring a safe vehicle status: when the last installation step is reached, a message appears on the central display after the ignition is switched off. Follow the

step-by-step instructions on the central display to complete the installation.

There are software updates that can only be installed when the vehicle is safely parked, there are no more people in the vehicle and the vehicle is locked. You can immediately install the software update, schedule it, or postpone it. If you schedule the software update and unlock the vehicle in the meantime, the installation must be rescheduled.

Availability of the driver display and central display

During the installation of software updates, it is not possible to use the vehicle, central display and driver display. You may receive the following display messages when an installation is running:

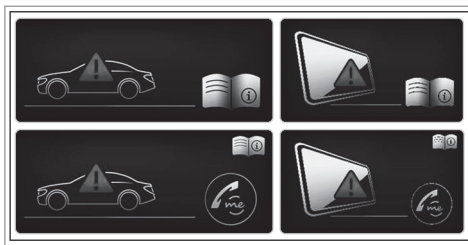

- ❗ The display message does not appear every time a software update is installed.

In rare cases, an error can occur during the installation. The multimedia system automatically attempts to restore the previous version.

If it is not possible to restore the previous version, the display messages shown above appear every time the engine is started.

Failure of the central display

If the central display fails or the display message shown above is shown continuously, several systems such as the rear view camera, PARKTRONIC or climate control are no longer

available. Drive on carefully and consult a specialist workshop as soon as possible.

Failure of the driver display

If the driver display fails or there is a malfunction, you may not recognize limitations in the functions of systems relevant to safety or the speed display, for example. The operating safety of the vehicle may be impaired. Drive on carefully and have the vehicle checked at a qualified specialist workshop immediately (→ page 513).

Further information about software updates can be found at <https://me.secure.mercedes-benz.com>.

Setting up a Wi-Fi hotspot

Requirements:

- Wi-Fi is activated on the multimedia system and the communication device to be connected.
- The communication device to be connected supports at least one of the types of connection described.

The connection types shown depend on the device to be connected. The function must be supported by the multimedia system and by the device to be connected. The type of connection established must be selected on the multimedia system and on the device to be connected.

- ❶ Some functions may first need to be activated on the communication device being connected. More detailed information can be found in the manufacturer's operating instructions.
- ❷ The use of the vehicle data tariff by external devices is not available in all countries.

Multimedia system:

→  » Settings » System
» Internet and Bluetooth

- ❶ The availability of the functions is dependent on the country.
- ▶ Select **Wi-Fi**.
The controller is to the right: Wi-Fi is switched on.

When Wi-Fi is switched on, you can connect the multimedia system with external hotspots or make it available as a hotspot for external devices.

When Wi-Fi is switched off, it is not possible to establish a hotspot connection.

When Wi-Fi is switched off, no connection can be established with the MBUX rear tablet.

- ❶ The data volume can be purchased **directly from a mobile phone network provider** via the Mercedes me Portal.
- ❷ The use of the vehicle data tariff by external devices is not available in all countries.

Using the multimedia system as a Wi-Fi hotspot

- ▶ Select **MBUX Hotspot**.
- ▶ Select one of the following connection options.

Connecting using a QR code

Requirement: an app for scanning the QR code is installed on the device being connected.

Alternatively: the device being connected has an integrated QR code scanner (see manufacturer's operating instructions).

- ▶ Scan the QR code shown.
The Wi-Fi connection is established.

Connecting using NFC

- ▶ Activate NFC on the device to be connected.
- ▶ When the NFC icon is displayed in the **MBUX Hotspot** menu, hold the device to be connected to the NFC interface.
- ▶ Follow the instructions on the device.
The Wi-Fi connection is established.

Connecting using a security key

- ▶ Select the vehicle from the device to be connected. The vehicle is displayed with the **MBUX XXXXX** network name.
- ▶ Enter the security key which is shown in the central display on the device to be connected.
- ▶ Confirm the entry.

Generating a new security key

- ▶ Select the hotspot name **MBUX XXXXX** in the **MBUX Hotspot** menu.
- ▶ Confirm the prompt with **Yes**.
A new security key is generated.

A connection will be established with the newly created security key.

- ① When a new security key is generated, all existing Wi-Fi connections are then disconnected. If the Wi-Fi connections are being re-established, the new security key must be entered.

Using a mobile communication device as a Wi-Fi hotspot (tethering)

An external Wi-Fi hotspot is accessed for the Internet connection of the multimedia system. The data tariff of the mobile communication device via **Purchased Data Plan** is used for the data connection.

- ① This function is country-dependent.
- ① With external Wi-Fi hotspots, which are encrypted via TKIP, online software updates

cannot be carried out via the external Wi-Fi hotspot.

- ▶ Select the **Set Up** option in the **Internet and Bluetooth** menu.
- ▶ Select **Connect to the Internet**.

Setting up an Internet connection via Wi-Fi

- ① The Wi-Fi function on the mobile phone and Internet access via Wi-Fi must be activated (see the manufacturer's operating instructions).

- ▶ Select **Search for Access**.
- ▶ Select the network.
- ▶ Log in to the Wi-Fi network.

or

- ▶ Select the mobile phone with the  Wi-Fi symbol.

System language

Notes on the system language

This function allows you to determine the language for the menu displays and the navigation announcements. The selected language affects

the characters available for entry. The navigation announcements are not available in all languages. If a language is not available, the navigation announcements will be in English.

Setting the language

Multimedia system:

- ▶  ▶ **Settings** ▶ **System**
▶ **Language**

Setting the system language

A list of the available system languages is shown.

- ▶ Select a language.
The system language is switched to the selected language.

Resetting the multimedia system (reset function)

⚠ WARNING Risk of accidents due to failure of the central display functions

While the multimedia system is being reset, its functions such as the rear view camera are not available.

- ▶ Only reset the multimedia system when the vehicle is stationary.

Requirements:

- The ignition is switched on.
- Some settings can only be reset when the vehicle is stationary.

Multimedia system:

→  ▶ Settings ▶ System ▶ Reset

When resetting the system, personal data and settings are deleted, for example:

- Connected devices
- Individual user profiles
- Biometric data

i The data used and saved in the multimedia system by the driver assistance systems is deleted.

- ▶ Select **Reset**.
A query appears asking if the system should really be reset.

- ▶ Select **Yes**.
The multimedia system is reset to the factory settings. The multimedia system is restarted after the system reset.

i Due to data protection, as well as the function of individual driving systems and driving safety systems, it is a requirement to carry out a complete system reset before selling the vehicle or transferring it to a third party, or after use as a hire car.

Navigation and traffic

Notes on navigation

Route guidance with augmented reality

⚠ WARNING Risk of accident and injury as a result of distraction, incorrect depiction or wrong interpretation of the display

The camera image of the augmented reality display is not suitable as a guide for driving.

- ▶ Always keep an eye on the actual traffic situation.
- ▶ Avoid extended observation of the camera image.

⚠ WARNING Risk of accident and injury due to imprecise positioning of additional information

The additional information from the augmented reality display may be inaccurate and is not a substitute for observing and assessing the actual driving situation.

- ▶ Always keep an eye on the actual traffic situation when carrying out all driving maneuvers.

Switching navigation on

Multimedia system:

→  ▶ Navigation

- ▶ Alternatively, activate the MBUX Voice Assistant (→ page 291).

- ▶ Switch to navigation. The map appears.

Navigation overview

Digital map

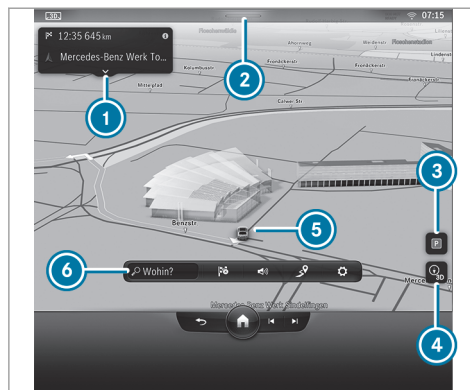

- ① Navigation window
Route guidance active: display for destination information, route list, lane recommendations, for example
- ② Calls up the Control Center in the status line
- ③ Searches for parking facilities in the vicinity

- ④ Selects the map orientation
- ⑤ Current vehicle position (vehicle symbol or arrow)
- ⑥ Navigation menu

Navigation menu

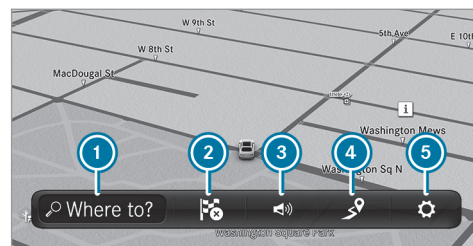

- ① Enters a POI or address and additional destination entries
- ② Interrupts route guidance (if route guidance is active)
- ③ Repeats a navigation announcement and switch navigation announcements on or off
- ④ Calls up **Route**, and **Traffic** menus

- Showing the route overview, entering intermediate destinations, selecting alternative routes
- Displaying traffic incidents and local area reports

- ⑤ Makes settings for [View](#), [Messages & Acoustic Signals](#) and [Route](#)
- ⓘ If the navigation menu is not shown, tap on the digital map.
- ⓘ The options are not available in all countries.

Entering a destination

Requirements:

- **For online search:** an Internet connection is established .
- Mercedes me connect is available.
- You have set up a user account in the Mercedes me Portal.
- The vehicle is connected with the user account and you have accepted the terms of use.

Further information can be found at: <https://www.mercedes.me>

- The service is available.
- The service has been activated at an authorized Mercedes-Benz Center.

Multimedia system:

Navigation » Where to?

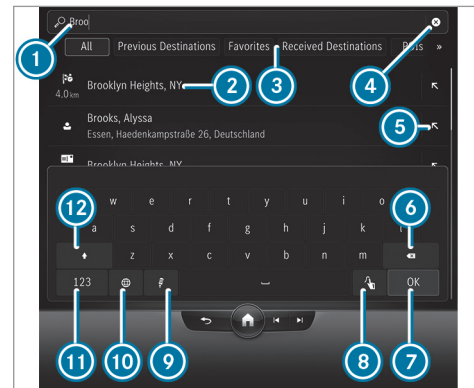

Example: entering a POI or address

- ① Input line with current entry
- ② Search result
- ③ Selects destination input, displays further destination inputs with double arrow
- ④ Deletes an entry

- 5 Adopts the search result in the input line and continues the search
 - 6 Deletes the last character entered
 - 7 Hides the keypad
 - 8 Switches to handwriting recognition
 - 9 Starts the MBUX Voice Assistant
 - 10 Sets the written language
 - 11 Switches to digits and special characters
 - 12 Switches to upper-case or lower-case letters
- ▶ Enter the destination in 1. The entries can be made in any order. The search results are displayed in a list.
- i Online search results for POIs may contain additional information, for example opening times and prices. The information is provided by an online map service. This online function is not available in all countries.
 - i You can enter a destination as a 3 word address from what3words. This option is not available in all countries.
- ▶ Hide the keyboard with .
- ▶ Select the destination in the list. The route is calculated.
- i Observe the notes on the MBUX multimedia system (→ page 287).

Calculating a route and using settings for route guidance



Example: detailed display

- 1 Calls up alternative routes
- 2 Calculates the route and starts route guidance
- 3 Selects a point of interest in the vicinity of the destination

- ④ Shares the destination
- ⑤ Saves a destination as a favorite
- ⑥ Destination address

After selection of a destination the route is be calculated.

- ▶ Select one of the options.

Calling up the route overview



- ▶ Select [Routes](#).
- ▶ Select an alternative route.

Starting route guidance

- ▶ Select  [Let's Go!](#).

Calling up the detailed display with destination address

- ▶ Pull the bar above the  [Let's Go!](#) symbol upwards.
Depending on the destination selection and availability, online content, for example ratings, prices and weather information, is shown.

- ▶ **To share a destination:** select  [Share](#) .
This option allows you to scan the displayed QR code.
- ▶ **To save a destination as a favorite:** select  [Favorite](#) and then an option.
- ▶ **To call up an Internet address:** if a web address is available, select [www](#).
- ▶ **To call the destination:** if a telephone number is available, select [Call](#).

Searching for POIs in the vicinity of the destination shown

- ▶ Select [In The Vicinity](#).
- ▶ Search using categories, enter a search entry or search for a personal POI .

Selecting a route type

- ▶ Select  in the navigation menu (→ page 308).
- ▶ Select [Route](#).
The route is calculated as a fast route with a short journey time. Trailer mode is available if a trailer has been coupled with the vehicle. If available, you can select online routes.

Traffic announcements for the route are taken into account via [Reroute Based on Traffic](#) .

- ① Trailer mode and online routes are not available in all countries and for all vehicles.

Calculating alternative routes



- ▶ Select  in the navigation menu.
- ▶ Select [View](#).
- ▶ Activate [Route Overview after Start](#).
Alternative routes are calculated for every route.

Selecting alternative routes

- ① If [Route Overview after Start](#) has been switched on and a route has been calculated, the function is available.
- ▶ Select  in the navigation menu.
- ▶ Select [Alternative Routes](#).
- ▶ When the alternative routes have been calculated, display the route in the navigation window by swiping to the right or left.
- ▶ Select [Start](#).

Activating a commuter route



 A user profile has been created and [Allow Destination Suggestions](#) has been activated in the user options (→ page 300). Route guidance is not active.

- ▶ Select  in the navigation menu.
- ▶ Select [Route](#).
- ▶ Activate [Activate Commuter Route](#).
The navigation system automatically detects that the vehicle is on a commuter route.
For the daily commuter route, traffic incidents on the route are also reported when driving without active route guidance.
- ▶ **To select or delete a commuter route:** select [Start](#) or .

Avoiding or using route sections, e.g. highways or ferries

- ▶ Select  in the navigation menu.
- ▶ Select [Route](#).
- ▶ Select [Avoid Options](#).
- ▶ Activate or deactivate the avoid option.

Activating route guidance with augmented reality

- ▶ Tap on  in the map.
The indicator lamp lights up blue.
The AR camera's video image is shown in the central display before a turning maneuver. The video image includes additional information.
- ▶ **To return to the navigation map:** tap on  again.
The indicator lamp is not lit.

Showing property information for route guidance with augmented reality

Road guidance with augmented reality is activated.

- ▶ Select  in the navigation menu.
- ▶ Select [View](#).
- ▶ Select [Augmented Reality Video](#).
- ▶ Activate [Street Names](#) and [House Numbers](#).
During route guidance, the activated options are shown as additional information in the camera image.

Using map functions

Multimedia system:

  [Navigation](#)

Increasing map scale

- ▶ When the map is shown, tap twice quickly with one finger on the central display.

Decreasing map scale

- ▶ When the map is displayed, tap the central display with two fingers.

Moving the map

- ▶ When the map is displayed, swipe in any direction with one finger on the central display.
- ▶ **To reset the map to the current vehicle position:** select  [Center](#) .

Selecting map orientation

- ▶ Tap repeatedly on the  compass symbol on the map.

The map orientations changes in this order:

- The 3D map view is aligned to the direction of travel.
- The 2D map view is aligned to the direction of travel.
- The 2D map view is displayed so that north is always at the top.
- The map shows the complete route.

Using services

Requirements:

- There is an Internet connection.
- Mercedes me connect is available.
- You have set up a user account in the Mercedes me Portal.
- The vehicle is connected to a user account and you have accepted the conditions of use for the service.

Further information can be found at: <https://www.mercedes.me>

- The service is available.
- The service has been activated at an authorized Mercedes-Benz Center.

Multimedia system:

  ▶▶ [Navigation](#)

Showing traffic information

- ▶ Select  in the navigation menu.
- ▶ Select [View](#).
- ▶ Select [Map Symbols](#).
- ▶ Activate [Traffic Incidents](#) and [Free Flowing Traffic](#).
Traffic incidents, for example roadworks, local area reports (e.g. fog) and warning messages, are shown on the route.

The traffic delay is displayed for the current route. The smallest value for the display for traffic delays is a minute.

Displaying hazard warnings

If hazard warnings are available these can be shown as symbols on the map. The display depends on the settings for the [Traffic Incidents](#) option.

- ▶ Set the option using .
If the option is activated, all of the symbols are shown.
- ▶ If the option is deactivated, the symbols are only shown when there is a hazard warning.

The following hazards may be shown on the map:

- Accidents and breakdowns
- Fog and ice
- Hazards reported manually
- Vehicle with active hazard warning light
- Mobile roadworks

Displaying online map contents

- ▶ Select  in the navigation menu.
- ▶ Select [View](#).
- ▶ Select [Map Symbols](#).

▶ Switch on an online service, e.g. [Weather](#). Current weather information is displayed on the navigation map, e.g. temperature or cloud cover.

The service information is not shown in all map scales, e.g. weather symbols.

Parking service

⚠ WARNING Risk of accident and injury due to not observing the maximum permitted access height

If the vehicle height is greater than the maximum permitted access height for parking garages, the roof and other parts of the vehicle may be damaged. Vehicle occupants may be injured.

- ▶ Before entering a parking garage or underground parking, observe the signposted entrance height.
- ▶ If the vehicle height is greater than the access height, do not enter.

! **NOTE** Before selecting the parking option

The data is based on information provided by the respective service provider.

Mercedes Benz accepts no liability for the accuracy of the information provided relating to the parking garage/parking lot.

- ▶ Always observe the local Information and conditions.

i This service is not available in all countries.

▶ Select  and activate [Parking](#).

▶ Tap on  in the map.

▶ Select a parking option.

The map shows the parking options in the vicinity.

The following information is displayed (if available):

- Destination address, distance from current vehicle position and arrival time
- Information on the parking garage/parking facility

For example, opening times, parking charges, current occupancy, maximum parking time, **maximum access height**.

The maximum access height shown by the parking service does not replace the need for observation of the actual circumstances.

- Available payment options (Mercedes pay, coins, bank notes, cards)
 - Details on parking tariffs
 - Number of available parking spaces
 - Payment method (e.g. at the parking meter)
 - Services/facilities at the parking option
 - Telephone number
- ▶ Calculate the route (→ page 310).

Notes on the dashcam

NOTE Before using the dashcam

You are legally responsible for operation and use of the dashcam functions. The legal requirements relating to operation and use of the dashcam can vary depending on the country in which the dashcam is operated. Therefore, observe the legal requirements, in particular the data protection regulations, in your country.

For this reason, before using the dashcam inform yourself about the regulation details for the respective country.

This function is not permitted in all countries.

- ▶ Observe the country-specific regulations.

- ❗ To ensure secure operation, only use FAT32 or exFAT formatted USB storage devices.
- ❗ The file size and therefore the duration of single recording is limited by the limitations of the USB flash drive format. So FAT32 for-

matted USB flash drives do not allow files larger than 4 GB, for example. When the file size is reached, the recording stops and you receive a notification.

Selecting a USB device for a video recording with the dashcam

Requirements:

- At least one USB device is connected with the multimedia system.

Multimedia system:

→  ▶ Apps ▶ Dashcam

- ▶ Select the USB symbol.
- ▶ Select the USB device.
- ❗ When USB devices contain multiple partitions, recorded video files are not always displayed in the recording list. Mercedes-Benz recommends that you use USB devices with one partition.

Starting or stopping video recording with the dashcam

Requirements:

- For recording and saving a video file: a USB device is connected with the multimedia system.
- The ignition is switched on.

Multimedia system:

→  ▶ Apps ▶ Dashcam

- ▶ If several USB devices are connected with the multimedia system, select a USB device (→ page 315). If no USB device is selected, a selection is made automatically when recording starts.
- ▶ **To select a recording mode:** select **Loop Recording** or **Individual Recording**. **Loop Recording** records several short video files. When the memory is full, recording is continued automatically. In doing so, other files will be overwritten starting with the oldest file. **Individual Recording** stops recording when the memory limit is reached. An individual

recording is automatically protected against being overwritten.

▶ **To start:** select **Start Recording**.

The length of the recording is shown. The **Please do not remove the storage medium** message appears. The video file is stored on the USB device.

▶ **To end:** select **End Recording**.

❗ In some countries, geo-coordinates (longitude and latitude) are shown in the video image.

For technical reasons, the geo-coordinates may show greater inaccuracies.

A report may appear in the following cases:

- **Individual Recording:** the memory is full or there are only a few minutes recording time available. The video recording stops or will be stopped imminently.

Change the USB device or delete a video file.

- The camera is not functional, the **Camera Unavailable** message appears.

Have the camera checked in an authorized Mercedes-Benz Center.

- If the country border indication has been switched on.
- If an outdoor recording is started with the camera app during a dashcam recording, the dashcam recording pauses and resumes automatically after the camera recording is finished. A notification to this effect is displayed.

Telephone

Telephony

Notes on telephony

⚠ **WARNING** Risk of distraction from operating integrated communication equipment while the vehicle is in motion

If you operate communication equipment integrated in the vehicle when driving, you could be distracted from the traffic situation. This could also cause you to lose control of the vehicle.

- ▶ Only operate this equipment when the traffic situation permits.
- ▶ If you cannot be sure of this, stop the vehicle whilst paying attention to road and traffic conditions and operate the equipment with the vehicle stationary.

⚠ **WARNING** Risk of an accident from operating mobile communication equipment while the vehicle is in motion

Mobile communications devices distract the driver from the traffic situation. This could also cause the driver to lose control of the vehicle.

- ▶ As the driver, only operate mobile communications devices when the vehicle is stationary.
- ▶ As a vehicle occupant, only use mobile communications devices in the areas intended for this purpose, e.g. in the rear passenger compartment.

You must observe the legal requirements for the country in which you are currently driving when

operating mobile communication equipment in the vehicle.

▲ WARNING Risk of injury due to objects being stowed incorrectly

If objects in the vehicle interior are stowed incorrectly, they can slide or be thrown around and hit vehicle occupants. In addition, cup holders, open stowage spaces and mobile phone receptacles cannot always retain all objects within.

There is a risk of injury, particularly in the event of sudden braking or a sudden change in direction.

- ▶ Always stow objects so that they cannot be thrown around in such situations.
- ▶ Always make sure that objects do not protrude from stowage spaces, parcel nets or stowage nets.
- ▶ Close the lockable stowage spaces before starting a journey.
- ▶ Always stow and secure heavy, hard, pointed, sharp-edged, fragile or bulky

objects in the trunk/cargo compartment.

Observe the additional information on stowing mobile communications devices correctly:

- Loading the vehicle (→ page 134)

Bluetooth® connection

The menu view and the available functions in the telephone menu are in part dependent on the Bluetooth® profile of the connected mobile phone. If the mobile phone supports all the following Bluetooth® profiles, the full range of features is available:

- PBAP (Phone Book Access Profile)
 - The contacts on the mobile phone are shown automatically on the multimedia system.
- MAP (Message Access Profile)
 - The mobile phone message functions can be used on the multimedia system.
- HFP (hands-free profile)
 - Wireless telephony is available on the multimedia system.

- SAP (SIM Access Profile)
 - The car telephone has access to the SIM card data and dials into the mobile phone network via the exterior antenna.

Irrespective of this, Bluetooth® audio functionality can be used with any mobile radio unit.

For information on the range of functions of the mobile radio unit to be connected, see the manufacturer's operating instructions.

Network connection:

The following cases can lead to the call being disconnected while the vehicle is in motion:

- You switch into a transmission/reception station, in which no communication channel is free.
- The SIM card used is not compatible with the network available
- A mobile phone with "Twincard" is logged into the network with the second SIM card at the same time

The multimedia system supports calls in HD Voice® for improved speech quality. A require-

ment for this is that the mobile phone and the mobile phone network provider of the person you are calling support HD Voice®.

Depending on the quality of the connection, the voice quality may fluctuate.

Further information can be obtained from an authorized Mercedes-Benz Center or at: <https://www.mercedes-benz.com/connect>

Telephone menu overview

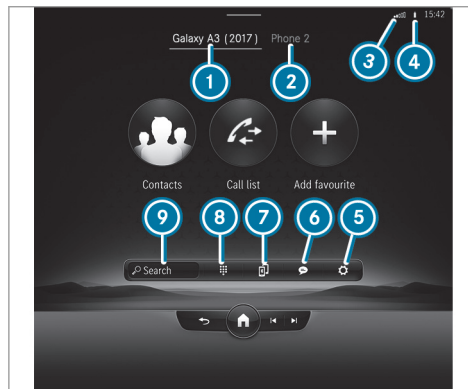

- ① Bluetooth® device name of the currently connected mobile phone/of the mobile phone
- ② Bluetooth® device name of the currently connected mobile phone/of the mobile phone (two phone mode)
- ③ Signal strength of the mobile phone network

- ④ Battery status of the connected mobile phone
- ⑤ Options
- ⑥ Messages
- ⑦ Calls up my devices
- ⑧ Numerical pad
- ⑨ Starts contact search

Telephony operating modes overview

Depending on your equipment, the following telephony operating modes are available:

- A mobile phone is connected to the multimedia system via Bluetooth®.
- Two mobile phones are connected with the multimedia system via Bluetooth® (two phone mode).
 - You can use all the functions of the multimedia system with both mobile phones.

Connecting a mobile phone

Requirements:

- Bluetooth® is activated on the mobile phone (see the manufacturer's operating instructions).
- Bluetooth® is activated on the multimedia system.

Multimedia system:

Home » Phone » Settings » Devices
 » My Devices

Searching for a mobile phone

- ▶ Select **Connect New Device**.

Connecting a mobile phone

- ▶ Select a mobile phone.
A code is displayed in the multimedia system and on the mobile phone.
- ▶ If both codes match, confirm the code on the mobile phone.

Functions in the telephony menu

In the telephony menu you have the following functions, for example:

- Making calls, e.g.:
 - Accept a call
 - End Call
 - Answering a call with a message
 - Conference
 - Accepting or rejecting a waiting call
- Managing contacts, e.g.:
 - Downloading mobile phone contacts
 - Managing the format of a contact's name
 - Deleting favorites
- Receiving and sending messages, e.g.:
 - Using the read-aloud function
 - Dictating a new message

Mercedes me and apps

Mercedes me connect

Information on Mercedes me connect

Mercedes me connect consists of multiple services.

You can use the following services via the multimedia system and the overhead control panel, for example:

- Accident and Breakdown Management (me button or situation-dependent display in the multimedia system)
- Mercedes-Benz emergency call system (automatic emergency call and SOS button)

The Mercedes me connect Accident and Breakdown Management and the Mercedes-Benz emergency call center are available to you around the clock.

The me button and the SOS button can be found on the vehicle's overhead control panel (→ page 321).

You can also call the Mercedes-Benz Customer Center using the multimedia system (→ page 322).

Please note that Mercedes me connect is a Mercedes-Benz service. In emergencies, first call the national emergency services using the standard national emergency service telephone numbers. In emergencies, you can also use the Mercedes-Benz emergency call system (→ page 327).

Please note the Mercedes me connect terms of use and the data protection information for Mercedes me connect. You can find these in your Mercedes me user account.

Further information about Mercedes me connect services can be obtained in the Mercedes me Portal: <https://me.secure.mercedes-benz.com>

Information on Mercedes me connect Accident and Breakdown Management

The Accident and Breakdown Management can include the following functions:

- Supplement to the Mercedes-Benz emergency call system (→ page 327)

If necessary, the contact person at the Mercedes-Benz emergency call center forwards the call to Mercedes me connect Accident and Breakdown Management. Forwarding the call is however not possible in all countries.

- Breakdown assistance by a technician on location and/or the towing away of the vehicle to the nearest authorized Mercedes-Benz Center

You may be charged for these services.

- Addition to the emergency guide after automatic accident or breakdown detection (→ page 322)

In the event of a breakdown or accident, further vehicle data is sent which enables optimal support by the Mercedes-Benz Customer Center and the authorized service partner or breakdown assistance.

- Addition to the Mercedes me connect service Telediagnosics

With the Telediagnosics function, specific wear and failure reports are recorded by the service provider, in so far as these can be

clearly interpreted and are available through the monitoring of components that are subject to diagnostics.

If your vehicle detects a breakdown or threat of a breakdown, you may be prompted via the multimedia system to contact the Mercedes-Benz Customer Center for further help. This prompt in the multimedia system only appears when the vehicle is stationary.

- ⓘ These services are subject to technical restrictions such as the mobile phone coverage, mobile network quality and the ability of the processing systems to interpret the transferred data. In some circumstances, this can result in delays or the failure of the information to appear in the multimedia system.

More information about Mercedes me connect services can be obtained in the Mercedes me Portal: <https://me.secure.mercedes-benz.com>

Data transferred during Mercedes me connect call services

The data transferred during a Mercedes me connect call depends on:

- The reason for initiation of the call
- The service that is selected in the voice control system
- The activated Mercedes me connect services

You can find out which data is transferred when using the services in the currently valid Mercedes me connect terms of use and the data protection information for Mercedes me connect. You can find these in your Mercedes me user account.

Mercedes me calls

Making a call via the overhead control panel

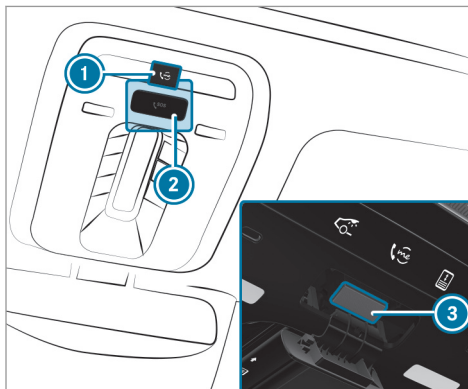

- ① me button for service or information calls
- ② SOS button cover
- ③ SOS button (emergency call system)

Making a Mercedes me call

- ▶ Press me button ①.

Making an emergency call

- ▶ To open the cover of SOS button ②, press it briefly.
- ▶ Press and hold SOS button ③ for at least one second.

If a Mercedes me call is active, an emergency call can still be triggered. This has priority over all other active calls.

Information about the Mercedes me call using the me button

A call to the Mercedes-Benz Customer Center has been initiated via the me button in the overhead control panel or the multimedia system (→ page 321).

Using the voice dialog system you access the desired service:

- Accident and Breakdown Management
- Mercedes-Benz Customer Center for general information about the vehicle

You can find information on the following topics:

- Activation of Mercedes me connect
- Operating the vehicle

- Nearest authorized Mercedes-Benz Center
- Other products and services from Mercedes-Benz

Data is transferred during the connection to the Mercedes-Benz Customer Center (→ page 323).

Calling the Mercedes-Benz Customer Center using the multimedia system

Requirements:

- Access to a GSM network is available.
- The contract partner's GSM network coverage is available in the respective region.
- The ignition must be switched on so that vehicle data can be transferred automatically.

Multimedia system:



▶ Call Mercedes me connect.

After confirmation, the multimedia system sends the required vehicle data. The data transfer is shown in the central display.

Then, you can select a service and be connected to a specialist at the Mercedes-Benz Customer Center.

Calling the Mercedes-Benz Customer Center after automatic accident or breakdown detection

Requirements:

- The vehicle has detected an accident or breakdown situation.
- The vehicle is stationary.
- The hazard warning lights are switched on.

i This function is not available in all countries.

The vehicle can detect accident or breakdown situations under certain circumstances.

In the event an accident or breakdown is detected, the emergency guide shows safety notes in the multimedia system display.

After quitting the emergency guide display on the multimedia system, a prompt appears asking whether you would like to get support from the Mercedes-Benz Customer Center.

▶ Select Call.

- After your agreement, or if the Mercedes me connect service "Accident and Breakdown Management" is active, the vehicle data is transferred automatically (→ page 320).
- The Mercedes-Benz Customer Center takes your call and organizes the breakdown and accident assistance.

You may be charged for these services.

i Depending on the severity of the accident, an automatic emergency call can be initiated. This has priority over all other active calls.

i In addition, if the Mercedes me connect service "Telediagnosics" is active, a similar prompt can appear after a delay in the event of a breakdown. If you are already in contact with the Mercedes-Benz Customer Center or have already received support, this prompt can be ignored or declined.

- ❗ If you answer the prompt for support from the Mercedes-Benz Customer Center with **Call Later**, the message will be hidden and appear again later.
- The prompt triggered by the Mercedes me connect service "Telediagnosics", can either be confirmed or declined. After being declined, this will not be shown again.

Arranging a service appointment via a Mercedes me call

If you have activated the maintenance management service, relevant vehicle data is transferred automatically to the Mercedes-Benz Customer Center. You will then receive individual recommendations regarding the maintenance of your vehicle.

Regardless of whether you have consented to the maintenance management service, the multimedia system reminds you after a certain amount of time that a service is due. A prompt appears asking if you would like to make an appointment.

▶ To arrange a service appointment: select **Call**.

After your agreement, the vehicle data is transferred and the Mercedes-Benz customer center takes your preferred appointment date. The information is then sent to your desired service outlet.

This will contact you to confirm the appointment and if necessary consult about the details.

- ❗ If you select **Call Later** after the service message appears, the message is hidden and reappears at a later time.

Transferred data during a Mercedes me call

If you initiate a service call using Mercedes me, data is transferred to enable targeted advice and an efficient service.

The following requirements must be fulfilled for the transfer of the data:

- The ignition is switched on.
- The required data transfer technology is supported by the mobile phone network provider.

- The quality of the mobile connection is sufficient.

Multi-stage transfer depends on the following factors:

- Reason for the initiation of the call
- The available mobile phone transmission technology.
- The activated Mercedes me connect services.
- The service selected in the voice control system.

Data transfer if Mercedes me connect services are not activated

If no Mercedes me connect services are activated, the following data is transferred:

- Vehicle identification number
- Time of the call
- Reason for the initiation of the call
- Confirmation of the data protection prompt
- Country indicator of the vehicle
- Set language for the multimedia system

324 MBUX multimedia system

- Telephone number of the communication platform installed in the vehicle

If a call is made for a service appointment via the service reminder, the following data is also transmitted:

- Current mileage and maintenance data

If a call is made after automatic accident or breakdown detection using the multimedia system, the following data is also transmitted:

- Current mileage and maintenance data
- Current vehicle location

If Accident and Breakdown Management is called via the voice control system, the following data can also be called up from the vehicle by the Mercedes-Benz Customer Center:

- Current vehicle location

Data processing

The data transmitted within the scope of the call is deleted from the processing system after the call is finished, in so far as this data is not being used for other activated Mercedes me connect services.

The incident-specific data is processed and stored in the Mercedes-Benz Customer Center and, if required to process the incident, forwarded to the service partner authorized by the Mercedes-Benz Customer Center. Please take note of the data protection information on the Mercedes me Internet page <https://www.mercedes.me> or in the recorded message immediately after calling the Mercedes-Benz Customer Center.

- ❗ The recorded message is not available in every country.

Overview of the Mercedes me & Apps menu

When you log in with a user account to the Mercedes me Portal, then services and offers from Mercedes-Benz will be available to you.

For more information consult an authorized Mercedes-Benz Center or visit the Mercedes me portal: <https://me.secure.mercedes-benz.com>

- ❗ Make sure you always keep the Mercedes me apps updated.

You can call up the menu using **Apps** in the multimedia system.

In the **Apps** menu, the following options can be available:

- Connecting the vehicle with the **Mercedes me** user account
- Deleting a connection between a **Mercedes me** user account and the vehicle
- Calling up the Mercedes me services
- Calling up apps such as, In-Car Office or the web browser depending on availability

Web browser overview

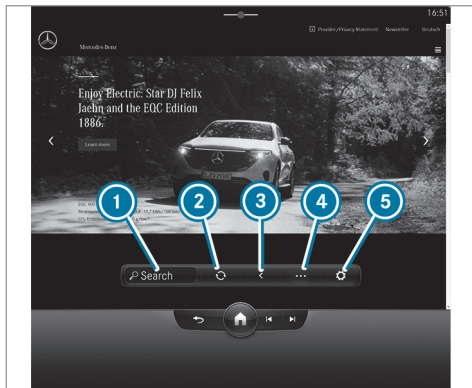

- 1 Search
- 2 To refresh/stop
- 3 Previous website
- 4 Options
- 5 Settings

i Under **[...]** you have the following options:

- **Bookmarks**
- **Request Mobile Website**
- **Tabs**

i Websites cannot be shown while the vehicle is in motion.

Overview of smartphone integration

With Smartphone Integration, you can use certain functions on your mobile phone via the multimedia system display.

Only one mobile phone at a time can be connected via Smartphone Integration to the multimedia system. Also for use with two phone mode with smartphone integration, only one additional mobile phone can be connected using Bluetooth® with the multimedia system.

The full range of functions for Smartphone Integration is only possible with an Internet connection. The appropriate application must be downloaded on the mobile phone to use Smartphone Integration. The mobile phone must be switched

on and connected to the multimedia system via the USB port using a suitable cable.

Apps for Smartphone Integration

- Mercedes-Benz Link (implementation of the function using the Mercedes-Benz Link control box)
- Apple CarPlay® (wireless connection via Bluetooth® also possible)
- Android Auto (wireless connection via Bluetooth® also possible)

i For safety reasons, the first activation of Mercedes-Benz Link, Apple CarPlay® or Android Auto on the multimedia system must be carried out when the vehicle is stationary and the parking brake is applied.

You can start Smartphone Integration using the **My Devices** menu.

You can end Smartphone Integration via the **My Devices** or by disconnecting the connecting cable between the mobile phone and multimedia system.

- ⓘ Mercedes-Benz recommends disconnecting the connection via the device manager or the connecting cable only when the vehicle is stationary.

Overview of transferred vehicle data

When using Smartphone Integration, certain vehicle data is transferred to the mobile phone. This enables you to get the best out of selected mobile phone services. Vehicle data is not directly accessible.

The following system information is transmitted:

- Software release of the multimedia system
- System ID (anonymized)

The transfer of this data is used to optimize communication between the vehicle and the mobile phone.

To do this, and to assign several vehicles to the mobile phone, a vehicle identifier is randomly generated.

This has no connection to the vehicle identification number (VIN) and is deleted when the multimedia system is reset (→ page 306).

The following driving status data is transmitted:

- Transmission position engaged
- Distinction between parked, standstill, rolling and driving
- Day/night mode of the instrument cluster
- Drive type

The transfer of this data is used to alter how content is displayed to correspond to the driving situation.

The following position data is transmitted:

- Coordinates
- Speed
- Compass direction
- Acceleration direction

This data is used by the mobile phone to improve the accuracy of the navigation (e.g. for continuation in a tunnel).

Mercedes-Benz emergency call system

Information on the Mercedes-Benz emergency call system

Your vehicle is equipped with the Mercedes-Benz emergency call system ("eCall"). This feature can help save lives in the event of an accident. eCall in no way replaces assistance provided from dialing 911.

Mercedes-Benz eCall only functions in areas where mobile phone coverage is available from the wireless service providers. Insufficient network coverage from the wireless service providers may result in an emergency call not being transmitted.

eCall is a standard feature in your Mercedes-Benz vehicle. In order to function as intended, the system relies on the transmission of data detailed in the Transmitted Data section that follows (→ page 328).

To disable eCall, a customer must visit an authorized Mercedes-Benz Service department to deactivate the vehicle's communication module.

Deactivation of this module prevents the activation of any and all Mercedes me connect services. After the deactivation of eCall, automatic emergency call and manual emergency call will not be available.

The ignition must be switched on before an automatic emergency call can be made.

- ① eCall is activated at the factory.
- ① eCall can be deactivated by an authorized Mercedes-Benz dealer. Please note that in the event ownership of the vehicle is transferred to another owner in its deactivated state, eCall will remain deactivated unless the new owner visits an authorized Mercedes-Benz dealership to reactivate the system.

Overview of the Mercedes-Benz emergency call system

eCall can help to reduce the time between an accident and the arrival of emergency services at the site of the accident. It helps locate an accident site in places that are difficult to access. However, even if a vehicle is equipped

with eCall, this does not mean the system is ON. As such, eCall does not replace dialing 911 in the event of an accident.

The emergency call can be made automatically (→ page 327) or manually (→ page 328). Only make emergency calls if you or others are in need of rescue.

Only make emergency calls if you or others are in need of rescue. Do not make an emergency call in the event of a breakdown or a similar situation.

Triggering an automatic Mercedes-Benz emergency call

Requirements:

- The ignition is switched on.
- The starter battery is sufficiently charged.

The Mercedes-Benz emergency call system triggers an emergency call automatically in the following cases:

- After activation of the restraint systems such as airbags or Emergency Tensioning Devices after an accident

- After an automatically initiated emergency stop by Active Emergency Stop Assist

The emergency call has been made:

- A voice connection is made to the Mercedes-Benz emergency call center.
 - A message with accident data is transmitted to the Mercedes-Benz emergency call center.
- The Mercedes-Benz emergency call center can transmit the vehicle position data to one of the emergency call centers.

The SOS button in the overhead control panel flashes until the emergency call is finished.

It is not possible to immediately end an automatic emergency call.

If no connection can be made to the emergency services either, a corresponding message appears in the media display.

▶ Dial the local emergency number on your mobile phone.

If an emergency call has been initiated:

- Remain in the vehicle if the road and traffic conditions permit you to do so until a voice

connection is established with the emergency call center operator.

- Based on the call, the operator decides whether it is necessary to call rescue teams and/or the police to the accident site.
- If no vehicle occupant answers, an ambulance is sent to the vehicle immediately.

Triggering a manual Mercedes-Benz emergency call

▶ **To use the SOS button in the overhead control panel:** press the SOS button at least one second long (→ page 321).

or

▶ **To use voice control:** use the voice commands of the MBUX Voice Assistant.

The emergency call has been made:

- A voice connection is made to the Mercedes-Benz emergency call center.
- A message with accident data is transmitted to the Mercedes-Benz emergency call center.

The Mercedes-Benz emergency call center can transmit the vehicle position data to one of the emergency call centers.

- Remain in the vehicle if the road and traffic conditions permit you to do so until a voice connection is established with the emergency call center operator.
- Based on the call, the operator decides whether it is necessary to call rescue teams and/or the police to the accident site.

If no connection can be made to the emergency services, a corresponding message appears in the central display.

▶ Dial the local emergency number on your mobile phone.

Ending an unintentionally triggered manual Mercedes-Benz emergency call

▶ **Select**  on the multifunction steering wheel. Depress the button for several seconds.

Data transfer of the Mercedes-Benz emergency call system

In the event of an automatic or manual emergency call the following data is transmitted, for example:

- Vehicle's GPS position data
- GPS position data on the route (a few hundred meters before the incident)
- Direction of travel
- Vehicle identification number
- Vehicle drive type
- Number of people determined to be in the vehicle
- Whether Mercedes me connect is available or not
- Whether the emergency call was initiated manually or automatically
- Time of the accident
- Language setting on the multimedia system

Data transmitted is vehicle information. For any questions about the collection, use and sharing of the eCall system data, please contact MBU-

SA's Customer Assistance Center at 800-FOR-MERC.

For Canada, please contact MBC's Customer Assistance Center at 1-800-387-0100.



Customer requests for covered information should be submitted via the same channels.









For accident clarification purposes, the following measures can be taken up to an hour after the emergency call has been initiated:



- The current vehicle position can be determined.
- A voice connection to the vehicle occupants can be established.

Radio & media

Overview of the symbols and functions in the media menu

Symbol	Designation	Function
	Play	Select to start or continue playback.
	Rest	Select to pause the playback.



Symbol	Designation	Function
	Repeat a track	Select to repeat the current track or the active playlist. <ul style="list-style-type: none">• Select once: the active playlist is repeated.• Select twice: the current track is repeated.• Select three times: the function is deactivated.
	Random playback	Select to play back the tracks in random order.
	Skip forwards/back	Select to skip to the next or to the previous track.
	Additional options	Select to show additional options.
	Categories	Select to show or search through available categories (e.g. playback lists, albums, artists, etc.).
	Search	Select to search in the active menu. You can search for artists, genres or moods, for example.
	Settings	Select to make settings.
	Home	Select to return to the home screen.



Symbol	Designation	Function
	Messaging	Select to call up messaging.
	Full screen	Select to switch to full screen mode.

The following functions and settings are available in the media menu:

- Connecting external data storage media with the multimedia system (e.g. using USB or Bluetooth®)
- Playing back audio or video files





Overview of the symbols and functions in the radio menu

Symbol	Designation	Function
	Home	Select to return to the home screen.
	Messaging	Select to call up messaging.
	Skip forwards/back	Select to skip to the next or to the previous station.

Symbol	Designation	Function
	Settings	Select to have further options shown. The setting options are country-dependent.
HD	HD radio®	Select to switch the HD Radio® function on or off. This function is not available in all countries.
	Station list	Select to have the station list shown.
	Search	Select to search in the active menu. You can search for artists, genres or moods, for example.

Additional functions of TuneIn Radio

-  A relatively large volume of data can be transmitted when using TuneIn Radio.



Symbol	Designation	Function
	Settings	The following additional settings are available in the TuneIn Radio menu: <ul style="list-style-type: none"> • Selecting stream • Logging on to or out of the TuneIn account
	Favourites	Select during playback to save the station currently set as a favorite.
	Play/Pause	Select to start, stop or continue playback.
	Browse	Select to choose a category and then a radio station.

Additional functions of the satellite radio

SIRIUS XM[®] satellite radio offers more than 175 digital-quality radio channels providing 100% commercial-free music, sports, news and entertainment, for example. SIRIUS XM[®] satellite radio employs a fleet of high-performance satel-

lites to broadcast around the clock throughout the USA and Canada. The satellite radio program is available for a monthly fee. Information about this can be obtained from a Sirius XM[®] Service Center and at <https://www.siriusxm.com> (USA) or <https://www.siriusxm.ca> (Canada).

 Sirius, XM and all related marks and logos are trademarks of Sirius XM Radio Inc. and its subsidiaries. All other marks, channel names and logos are the property of their respective owners. All rights reserved.

Symbol	Designation	Function
	Settings	The following additional settings are available in the satellite radio menu: <ul style="list-style-type: none"> • Activate child safety lock to lock channels with adult content • Set alarm programming for music and sport alerts • Create TuneMix lists to listen to music seamlessly
	Play	Select to start or continue playback.
	Rest	Select to pause the playback.

Depending on the frequency band selected, different functions are available to you.

Select the desired frequency band in the radio menu head runner.

Calling up TuneIn Radio

Requirements:

- There is a user account at <https://www.mercedes.me>.
- The vehicle is linked to the Mercedes me user account.
- The TuneIn Radio service is activated in the Mercedes me portal.

- The data volume is available.
Depending on the country, data volume may need to be purchased.
 - A fast Internet connection for data transmission free of interference.
-  Data volume can be purchased **directly from a mobile phone network provider** via the Mercedes me Portal.

-  The functions and services are country-dependent. For more information, consult an authorized Mercedes-Benz Center.

Multimedia system:

  Radio

- ▶ Select **TuneIn Radio**.

The TuneIn menu appears. The last station set starts playing.

-  The connection quality depends on the local mobile phone reception.

Setting up satellite radio

Requirements:

- Satellite radio equipment is available.
- Registration with a satellite radio provider has been completed.
- If registration is not included when purchasing the system, your credit card details will be required to activate your account.

Multimedia system:

  Radio  SiriusXM
▶ 

- ▶ Select **Service Information**.

The service information screen appears showing the radio ID and the current subscription status.

- ▶ Establish a telephone connection.

- ▶ Follow the service staff's instructions. The activation process may take up to ten minutes.

-  You can also have the satellite service activated online. To do so, please visit <https://www.siriusxm.com> (USA) or <https://www.siriusxm.ca> (Canada).

Music and sport alerts

Multimedia system:

  Radio  SiriusXM
▶  ▶ Alerts

Setting music and sport alerts

This function enables you to program an alert for your favorite artists, tracks or sporting events. Music alerts can be saved whilst a track is being played and sport alerts can be saved during a live game. You can also specify sport alerts via the menu option. The system then continuously searches through all the channels.

- ▶ Set a music or sports alert, to be informed of matches in the live program.

Activating messages for a category

- ▶ Select a category and activate .

Adding messages for a category

- ▶ Select a category and add a message .
- ▶ Select **Artist Alerts** or **Song Alerts** in the dialog window. The message is set for the activated track and artist. If a match is found, a prompt

appears asking whether you wish to change to the station.

Deleting messages in a category

▶ Select a category, mark the desired messages and delete .

or

▶ Do not mark any messages and delete all entries .

Sound settings

Overview of functions in the sound menu

The setting options and functions available depend on the sound system installed. You can find out which sound system is installed in your vehicle in the Digital Operator's Manual.

Standard sound system

The following functions are available:

- Equalizer:
 - Treble, mid-range and bass
- Balance and fader
- Volume:

- Automatic adjustment

Burmester® 3D-surround sound system and Burmester® high-end 4D surround sound system

The following functions are available:

- Equalizer:
 - Treble, mid-range and bass
- Balance and fader
- Sound focus
- VIP seat (Burmester® high-end 4D surround sound system only)
- Sound profiles
- Volume:
 - Automatic adjustment

ASSYST PLUS service interval display

Function of the ASSYST PLUS service interval display

The ASSYST PLUS service interval display on the driver display provides information on the remaining time or distance before the next service due date.

You can hide this service display using the back button on the left-hand side of the steering wheel.

Depending on how the vehicle is used, the ASSYST PLUS service interval display may shorten the service interval, e.g. in the following cases:

- Mainly short-distance driving
- When the engine is often left idling for long periods
- In the event of frequent cold start phases

Mercedes-Benz recommends avoiding such operating conditions.

You can obtain information concerning the servicing of your vehicle from a qualified specialist

workshop, e.g. an authorized Mercedes-Benz Center.

Displaying the service due date

Driver display:



Service

The next service due date is displayed.

▶ **To exit the display:** press the back button on the left-hand side of the steering wheel.

Bear in mind the following related topic:

- Operating the driver display (→ page 280).

Information on regular maintenance work

! **NOTE** Premature wear through failure to observe service due dates

Maintenance work which is not carried out at the right time or incompletely can lead to increased wear and damage to the vehicle.

▶ Adhere to the prescribed service intervals.

▶ Always have the prescribed maintenance work carried out at a qualified specialist workshop.

Notes on special service requirements

The prescribed service interval is based on normal operation of the vehicle. Have the maintenance work carried out more often than prescribed if operating conditions are difficult or the vehicle is subject to increased stress.

The ASSYST PLUS service interval display is only an aid. The driver of the vehicle bears responsibility as regards to whether maintenance work needs to be performed more often than specified based on the actual operating conditions and/or loads.

Examples of arduous operating conditions:

- Regular city driving with frequent intermediate stops
- Mainly short-distance driving
- Frequent operation in mountainous terrain or on poor road surfaces

- When the engine is often left idling for long periods
- Operation in particularly dusty conditions and/or if air-recirculation mode is frequently used

In these or similar operating conditions, have the interior air filter, air filter, engine oil and oil filter, for example, changed more frequently. The tires must be checked more frequently if the vehicle is operated under increased loads. Further information can be obtained at a qualified specialist workshop.

Battery disconnection periods

The ASSYST PLUS service interval display can calculate the service due date only when the battery is connected.

- ▶ Display the service due date on the driver display and note it down before disconnecting the battery (→ page 337).

Engine compartment

Opening and closing the hood

⚠ WARNING Risk of accident due to driving with the hood unlocked

The hood may open and block your view.

- ▶ Never release the hood when driving.
- ▶ Before every trip, ensure that the hood is locked.

⚠ WARNING Risk of accident and injury when opening and closing the hood

The hood may suddenly drop into the end position.

There is a risk of injury for anyone in the hood's range of movement.

- ▶ Do not open or close the hood if there is a person in the hood's range of movement.

⚠ WARNING Risk of burns when opening the hood

If you open the hood when the engine has overheated or when there is a fire in the engine compartment, the following situations may occur:

- You could come into contact with hot gases.
 - You could come into contact with other hot, escaping operating fluids.
- ▶ Before opening the hood, allow the overheated engine to cool down.
 - ▶ In the event of a fire in the engine compartment, keep the hood closed and call the fire service.

⚠ WARNING Risk of injury due to moving parts

Components in the engine compartment may continue running or start up suddenly, even if the ignition is switched off.

Make sure of the following before performing tasks in the engine compartment:

- ▶ Switch the ignition off.
- ▶ Never reach into the danger zone surrounding moving components, e.g. the rotation area of the fan.
- ▶ Remove jewellery and watches.
- ▶ Keep items of clothing and hair away from moving parts.

⚠ WARNING Risk of injury from touching components under voltage

The ignition system and the fuel injection system work under high voltage. You could receive an electric shock.

- ▶ Never touch components of the ignition system or the fuel injection system when the ignition is switched on.

The live components include the following, for example:

- Ignition coils

- Fuel injectors
- Electric lines to the ignition coils or the fuel injectors

⚠ WARNING Risk of burns from hot component parts in the engine compartment

Certain component parts in the engine compartment can be very hot, e.g. the engine, the cooler and parts of the exhaust system.

- ▶ Allow the engine to cool down and only touch component parts described in the following.

⚠ WARNING Risk of injury from using the windshield wipers while the engine hood is open

When the engine hood is open and the windshield wipers are set in motion, you can be trapped by the wiper linkage.

- ▶ Always switch off the windshield wipers and ignition before opening the engine hood.

Opening the hood

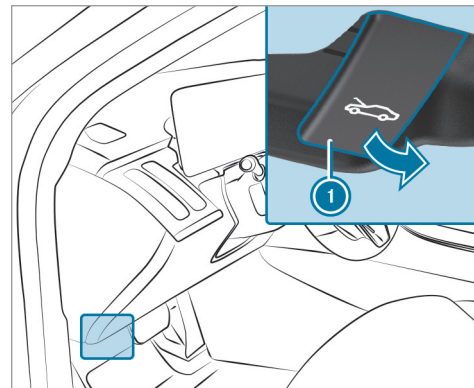

- ▶ Pull on handle ① twice. The hood will be released and open slightly.
- ▶ Then lift the hood by hand.

Closing the hood

NOTE Damage to the hood

If the hood is closed manually, there is a risk of dents.

- ▶ Do not close the hood manually.

- ▶ Lower the hood to a height of around 8 in (20 cm) and then allow it to fall, applying a little force as you let it go.
- ▶ If the hood can still be lifted slightly, open the hood again and close it with a little more force until it engages correctly.

Engine oil

Checking the engine oil level with the driver display

Requirements:

- The engine has been warmed up.
- The vehicle is parked on a level surface.
- The engine is running at idle speed.
- The hood is closed.

The engine oil level is determined during driving. Determining the engine oil level can take up to 30 minutes with a normal driving style and even longer with an active driving style.

Driver display:



The engine oil level is shown.

One of the following messages will appear on the driver display:

- **Engine Oil Level Measuring Now...**: measurement of the oil level is not yet possible.
- ▶ Repeat the request after a maximum of 30 minutes' driving.
- **Engine Oil Level OK** and the bar display for indicating the oil level on the driver display is green and is between "min" and "max": the oil level is correct.
- **Engine Oil Level Refill 1,0 liq.gal.** and the bar display for indicating the oil level on the driver display is yellow and is below "min":
- ▶ Add 1.1 US qt (1 l) of engine oil.

- **Engine Oil Level Reduce** and the bar display for indicating the oil level on the driver display is yellow and is above "max":

▶ Drain off any excess engine oil that has been added. To do so, consult a qualified specialist workshop.

- **For Engine Oil Level Switch On Ignition**

▶ Switch on the ignition to check the engine oil level.

- **Engine Oil Level System Inoperative**: The oil level sensor is defective or not connected.

▶ Consult a qualified specialist workshop.

- **Engine Oil Level Currently Unavailable**

▶ Close the hood.

Refilling engine oil

WARNING Risk of burns from hot component parts in the engine compartment

Certain component parts in the engine compartment can be very hot, e.g. the engine, the cooler and parts of the exhaust system.

- ▶ Allow the engine to cool down and only touch component parts described in the following.

⚠ WARNING Risk of fire and injury from engine oil

If engine oil comes into contact with hot component parts in the engine compartment, it may ignite.

- ▶ Make sure that no engine oil is spilled next to the filler opening.
- ▶ Allow the engine to cool off and thoroughly clean the engine oil from component parts before starting the vehicle.

! NOTE Engine damage caused by an incorrect oil filter, incorrect oil or additives

- ▶ Do not use engine oils or oil filters which do not correspond to the specifications explicitly prescribed for the service intervals.

- ▶ Follow the instructions on the service interval display for changing the engine oil and observe the prescribed change intervals.
- ▶ Do not use additives.

! NOTE Damage caused by refilling too much engine oil

Too much engine oil can damage the engine or the catalytic converter.

- ▶ Have excess engine oil removed at a qualified specialist workshop.

- ① Depending on driving style, the vehicle consumes up to 0.9 US qt (0.8 liter) of oil per 600 miles (1000 km). The oil consumption may be higher than this when the vehicle is new or if you frequently drive at high engine speeds.
- ① Depending on the engine, the cap may be installed in the engine compartment in different locations.

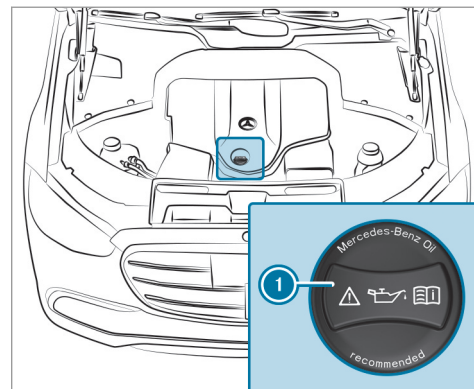

- ▶ Turn cap ① counter-clockwise and remove it.
- ▶ Add engine oil.
- ▶ Replace cap ① and turn it clockwise until it engages.
- ▶ Check the oil level again (→ page 340).

Checking the coolant level

⚠ WARNING Risk of burns from hot component parts in the engine compartment

Certain component parts in the engine compartment can be very hot, e.g. the engine, the cooler and parts of the exhaust system.

- ▶ Allow the engine to cool down and only touch component parts described in the following.

⚠ WARNING Risk of scalding from hot coolant

If you open the cap, you could be scalded.

- ▶ Let the motor cool down before opening the cap.
- ▶ When opening the cap, wear protective gloves and safety glasses.
- ▶ Open the cap slowly to release pressure.

- ▶ Only have the coolant checked or refilled at a qualified specialist workshop.

Refilling the windshield washer system

⚠ WARNING Risk of burns from hot component parts in the engine compartment

Certain component parts in the engine compartment can be very hot, e.g. the engine, the cooler and parts of the exhaust system.

- ▶ Allow the engine to cool down and only touch component parts described in the following.

⚠ WARNING - Risk of fire and injury from windshield washer concentrate

Windshield washer concentrate is highly flammable. It could ignite if it comes into contact with hot engine component parts or the exhaust system.

- ▶ Make sure that no windshield washer concentrate spills out next to the filler opening.

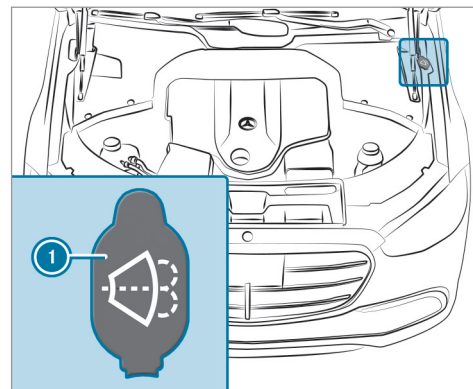

- ▶ Remove cap ① by the tab.

- ▶ Add washer fluid.

- ⓘ Further information about the windshield washer fluid (→ page 500)

Keeping the air-water duct free

- ▶ Keep the area between the hood and the windshield free of deposits, e.g. ice, snow and leaves.

Cleaning and care

Notes on washing the vehicle in a car wash

⚠ WARNING Risk of accident due to reduced braking effect after washing the vehicle

The braking effect is reduced after washing the vehicle.

- ▶ After the vehicle has been washed, brake carefully while paying attention to the traffic conditions until the braking effect has been fully restored.

! NOTE Damage from automatic braking

If one of the following functions is switched on, the vehicle brakes automatically in certain situations:

- Active Brake Assist
- Active Distance Assist DISTRONIC
- HOLD function
- Active Parking Assist

To avoid damage to the vehicle, deactivate these systems in the following or similar situations:

- ▶ During towing
- ▶ In a car wash

! NOTE Damage due to unsuitable car wash

- ▶ Before driving into a car wash make sure that the car wash is suitable for the vehicle dimensions.

- ▶ Ensure there is sufficient ground clearance between the underbody and the guide rails of the car wash.
- ▶ Ensure that the clearance width of the car wash, in particular the width of the guide rails, is sufficient.

To avoid damage to your vehicle when using a car wash, ensure the following beforehand:

- Active Distance Assist DISTRONIC is deactivated.
- The HOLD function is switched off.
- The surround view camera or the rear view camera is switched off.
- The vehicle is locked and the door handles retracted.
- The side windows and sliding sunroof are completely closed.
- The blower for the ventilation and heating is switched off.
- The windshield wiper switch is in position **0**.

- The SmartKey is at a minimum distance of 20 ft (6 m) away from the vehicle. Otherwise, the trunk lid or a door could open unintentionally.
 - For car washes with a conveyor system:
 - Neutral **N** is engaged.
 - The vehicle is locked from inside.
 - Do not make any hand movements in the area of the overhead control panel or deactivate (→ page 302) the [Sliding Sunroof and Roller Sunblind](#) option in the settings for the MBUX Interior Assistant.
- i** If, after the car wash, you remove the wax from the windshield and wiper rubbers, this will prevent smearing and reduce wiper noise.

Notes on using a power washer

⚠ WARNING Risk of an accident when using power washers with round-spray nozzles

The water jet can cause externally invisible damage.

Components damaged in this way may unexpectedly fail.

- ▶ Do not use a power washer with round-spray nozzles.
- ▶ Have damaged tires or chassis parts replaced immediately.

To avoid damage to your vehicle, observe the following when using a power washer:

- The SmartKey is at a minimum distance of 10 ft (3 m) away from the vehicle. Otherwise, the trunk lid or a door could open unintentionally.
- Maintain a distance of at least 11.8 in (30 cm) to the vehicle.

- **Vehicles with decorative foil:** Parts of your vehicle are covered with a decorative foil. Maintain a distance of at least 27.6 in (70 cm) between the foil-covered parts of the vehicle and the nozzle of the power washer. Move the power washer nozzle around whilst cleaning. The water temperature of the power washer must not exceed 140°F (60°C).
- Observe the information on the correct distance in the equipment manufacturer's operating instructions.
- Do not direct the nozzle of the power washer directly at sensitive parts, such as tires, gaps, electrical components, batteries, light sources and ventilation slits.

Washing the vehicle by hand

! **NOTE** Engine damage due to water ingress

▶ Take care not to point the water jet directly towards the air inlet grille below the hood.

Observe the legal requirements, e.g. in a number of countries, washing by hand is only permitted in specially designated wash bays.

- ▶ Use a mild cleaning agent, e.g. car shampoo.
- ▶ Wash the vehicle with lukewarm water using a soft car sponge. When doing so, do not expose the vehicle to direct sunlight.
- ▶ Carefully hose the vehicle off with water and dry using a chamois.

i Observe the notes on the care of vehicle parts (→ page 346).

Notes on paintwork/matte finish paintwork care

To avoid damaging the paintwork and interfering with the driving assistance systems, please observe the following notes:

Paint

- Insect remains: soak with insect remover and rinse off the treated areas afterwards.
- Bird droppings: soak with water and rinse off afterwards.
- Tree resin, oils, fuels and greases: remove by rubbing gently with a cloth soaked in petroleum ether or lighter fluid.
- Coolant and brake fluid: remove with a damp cloth and clean water.
- Tar stains: use tar remover.
- Wax: use silicone remover.
- Do not attach stickers, films or similar materials. Only have film attached to the bumper at a qualified specialist workshop.
- Remove dirt immediately, where possible.

Matte finish

- Only use care products approved for Mercedes-Benz.
- Do not attach stickers, films or similar materials. Only have film attached to the bumper at a qualified specialist workshop.
- Do not polish the vehicle and alloy wheels.
- Only use car washes that correspond to the latest engineering standards.
- Do not use car wash programs with a final hot wax treatment.
- Do not use paint cleaners, buffing or polishing products, gloss preservers, e.g. wax.

In the event of paintwork damage:

- Always have paintwork repairs carried out at a qualified specialist workshop.
- Make sure the radar sensors function (→ page 218).

Notes on cleaning decorative foils

Observe the notes on matte finish care in the chapter "Notes on paintwork/matte finish paint-

work care" (→ page 345). They also apply to matte decorative foils.

Observe the notes on cleaning decorative foils to avoid vehicle damage.

Cleaning

- For cleaning, use plenty of water and a mild cleaning agent without additives or abrasive substances, e.g. a car shampoo approved for Mercedes-Benz.
- Remove dirt immediately, where possible, whilst avoiding rubbing too hard. There is otherwise a risk of damaging the decorative foil irreparably.
- If there is dirt on the finish or if the decorative foil is dull: use the Paint Cleaner recommended and approved for Mercedes-Benz.
- Insect remains: soak with insect remover and rinse off the treated areas afterwards.
- Bird droppings: soak with water and rinse off afterwards.
- To prevent water stains, dry a foil-wrapped vehicle with a soft, absorbent cloth after every car wash.

Avoiding damage to the decorative foil

- The service life and color of decorative foils are impaired by:
 - Sunlight
 - Temperature, e.g. hot air blower
 - Weather conditions
 - Stone chippings and dirt
 - Chemical cleaning agents
 - Oily products
- Do not use polish on matte decorative foil. Polishing will have the effect of shining the foil-wrapped surface.
- Do not treat matte or structured decorative foils with wax. Permanent stains may occur.

Scratches, corrosive deposits, areas affected by corrosion and damage caused by incorrect care cannot always be completely repaired. In such cases, visit a qualified specialist workshop.

You can obtain more information on care and cleaning products from the manufacturer.

In the case of foil-wrapped surfaces, optical differences may occur between the surfaces that

were not protected by a decorative foil after removing a decorative foil.

- ⓘ Have work or repairs to decorative foils carried out at a qualified specialist workshop, e.g. at an authorized Mercedes-Benz Center.

Notes on care of vehicle parts

⚠ WARNING Risk of entrapment if the windshield wipers are switched on while the windshield is being cleaned

If the windshield wipers are set in motion while you are cleaning the windshield or wiper blades, you can be trapped by the wiper arm.

- ▶ Always switch off the windshield wipers and the ignition before cleaning the windshield or wiper blades.

⚠ WARNING Risk of burns from the tailpipe and tailpipe trims

The exhaust tailpipe and tailpipe trims can become very hot. If you come into contact with these parts of the vehicle, you could burn yourself.

- ▶ Always be particularly careful around the tailpipe and the tailpipe trims and supervise children especially closely in this area.
- ▶ Allow vehicle parts to cool down before touching them.

To avoid damage to the vehicle, observe the notes on cleaning and care of the following vehicle parts:

Wheels and rims

- Use water and acid-free alloy wheel cleaners.
- Do not use acidic alloy wheel cleaners to remove brake dust. This could damage wheel bolts and brake components.
- To avoid corrosion of the brake discs and brakepads, drive the vehicle for a few

minutes after cleaning before parking it. The brake discs and brakepads warm up and dry out.

Windows

- Clean the windows inside and outside with a damp cloth and with a cleaning agent recommended for Mercedes-Benz.
 - Do not use dry cloths or abrasive or solvent-based cleaning agents to clean the inside of windows.
- ⓘ After changing the wiper blades or treating the vehicle with wax, clean the windshield thoroughly with cleaning agents recommended for Mercedes-Benz. Failure to observe the application instructions may result in damage, smear marks or blinding spots.
- ⓘ Remove external fogging or dirt on the windshield in front of the multifunction camera. Otherwise, driving systems and driving safety systems may be impaired or not available (→ page 218).

Wiper blades

- Move the wiper arms into the replacement position (→ page 168).
 - With the wiper arms folded out, clean the wiper blades with a damp cloth.
- ⓘ Make sure that the wiper blades are coated. The coating can leave residues on a cloth. Do not rub the wiper blades excessively or clean them too often.

Exterior lighting

- Clean the lenses with a wet sponge and mild cleaning agent, e.g. car shampoo.
- Only use cleaning agents or cleaning cloths that are suitable for plastic lenses.

Sensors

- Clean the sensors in the front and rear bumpers with a soft cloth and car shampoo (→ page 218).
- When using a power washer, maintain a minimum distance of 11.8 in (30 cm).

Rear view camera and surround view camera

- Open the camera cover with the multimedia system (→ page 268).
- Use clean water and a soft cloth to clean the camera lens.
- Do not use a power washer.

Tailpipes

- Clean with a cleaning agent recommended for Mercedes-Benz, especially in the winter and after washing the vehicle.
- Do not use acidic cleaning agents.

Notes on care of the interior

⚠ WARNING Risk of injury from plastic parts breaking off after the use of solvent-based care products

Care and cleaning products containing solvents can cause surfaces in the cockpit to become porous. When the airbags are deployed, plastic parts may break away.

▶ Do not use any care or cleaning products containing solvents to clean the cockpit.

⚠ WARNING Risk of injury or death from bleached seat belts

Bleaching or dyeing seat belts can severely weaken them.

This can, for example, cause seat belts to tear or fail in an accident.

▶ Never bleach or dye seat belts.

To avoid damage to the vehicle, observe the following notes on cleaning and care:

Seat belts

- Clean with lukewarm and soapy water.
- Do not use chemical cleaning agents.
- Do not dry by heating them to over 176°F (80°C) or exposing them to direct sunlight.

Display

- Switch off the display and let it cool down.

- Clean the surface carefully with a microfiber cloth and a suitable display care product (TFT-LCD).
- Do not use any other agents.

Head-up Display

- Clean with a soft, non-static, lint-free cloth.
- Do not use cleaning agents.

Plastic trim

- Clean with a damp microfiber cloth.
- For heavy soiling: Use a cleaner recommended for Mercedes-Benz.
- Do not attach stickers, films or similar materials.
- Do not allow cosmetics, insect repellent or sun cream to come in contact with the plastic trim.

Real wood and trim elements

- Clean with a microfiber cloth.
- Black piano-lacquer look: Clean with a damp cloth and soapy water.
- For heavy soiling: Use a cleaner recommended for Mercedes-Benz.

- Do not use solvent-based cleaning agents, polishes or waxes.

Headliner

- Clean with a brush or dry shampoo.

Carpet

- Use a carpet and textile cleaning agent recommended for Mercedes-Benz.

Steering wheel made of genuine leather or DINAMICA

! NOTE Damage caused by wrong cleaners

▶ Do not use solvent-based cleaning agents such as tar remover or wheel cleaner; neither should you use polishes or waxes. Otherwise you may damage the finish.

- Clean with a damp cloth and 1% soapy water solution and then wipe with a dry cloth.
- For heavy soiling: Use a cleaner recommended for Mercedes-Benz.
- Leather care: Use a leather care agent that has been recommended for Mercedes-Benz.

- Do not allow the leather to become too damp.
- Do not use a microfiber cloth.

i Leather is a natural product. It has natural surface properties, such as differences in structure, marks caused by growth and injury or subtle color differences.

Genuine leather seat covers

- Clean with a damp cloth and then wipe with a dry cloth.
- Leather care: Use a leather care agent that has been recommended for Mercedes-Benz.
- Do not allow the leather to become too damp.
- Do not use a microfiber cloth.

DINAMICA seat covers

- Clean with a damp cloth.
- Do not use a microfiber cloth.

Fabric seat covers

- Clean with a damp microfiber cloth and 1% soapy water and allow to dry.

EASY-PACK trunk box

- Clean with a damp cloth.
- Do not use any alcohol-based thinners, gasoline or abrasive cleaning agents.

Emergency

Removing the safety vest

The safety vests are located in storage spaces in the front door.

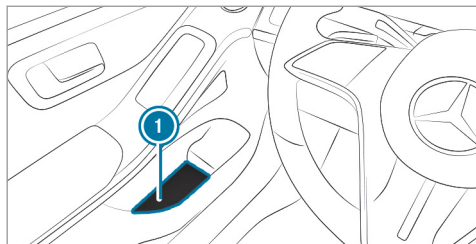

- ▶ Take the safety vest bag out of storage space ①.

- ▶ Open the safety vest bag and pull out the safety vest.

- ① Safety vests can also be stored in the rear door storage spaces.

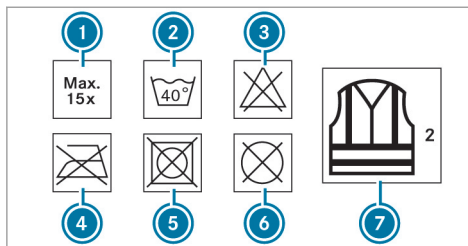

- ① Maximum number of washes
- ② Maximum wash temperature
- ③ Do not bleach
- ④ Do not iron
- ⑤ Do not tumble dry
- ⑥ Do not dry clean
- ⑦ This is a class 2 vest

The requirements defined by the legal standard are only fulfilled in the following cases:

- The safety vest is the correct size
- The safety vest is fully closed whilst being worn

Replace the safety vest in the following cases:

- The reflective strips are damaged or dirt on the reflective strips can no longer be removed
- The maximum number of washes is exceeded
- The fluorescence has faded

Warning triangle

Removing the warning triangle

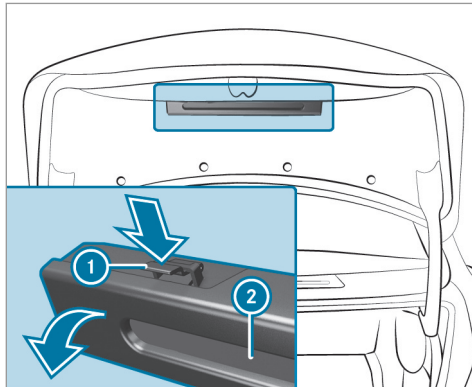

- ▶ Push both sides of warning triangle holder ① in the direction of the arrow and open it.
- ▶ Remove warning triangle ②.

Setting up the warning triangle

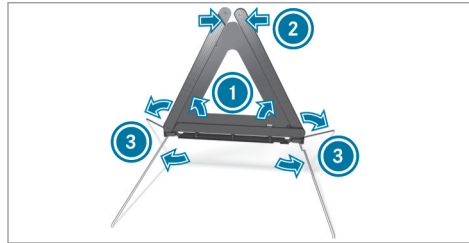

- ▶ Fold side reflectors ① upwards to form a triangle and attach at the top using upper press-stud ②.
- ▶ Fold legs ③ down and out to the side.

First-aid kit (soft sided)

First-aid kit (soft sided) ① is located on the right-hand side of the trunk and is secured with Velcro strip ②.

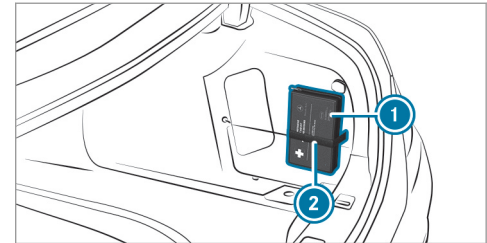

Flat tire

Notes in the event of a flat tire

⚠ WARNING Risk of accident due to a flat tire

A flat tire severely affects the driving characteristics as well as the steering and braking of the vehicle.

Tires without run-flat characteristics:

- ▶ Do not drive with a flat tire.
- ▶ Change the flat tire immediately with an emergency spare wheel or spare wheel.

Alternatively, consult a qualified specialist workshop.

Tires with run-flat characteristics:

- ▶ Observe the information and warning notes on MOExtended tires (run-flat tire).

In the event of a flat tire, the following options are available depending on your vehicle's equipment:

- **Vehicles with MOExtended tires:** it is possible to continue the journey for a short period of time. Make sure you observe the notes on MOExtended tires (run-flat tires) (→ page 352).
- **Vehicles with a TIREFIT kit:** you can repair the tire so that it is possible to continue the journey for a short period of time. To do this, use the TIREFIT kit (→ page 353).
- **Vehicles with Mercedes me connect:** you can make a call for breakdown assistance via the overhead control panel in the case of a breakdown (→ page 321).

- **All vehicles:** change the wheel (→ page 396).
- ❗ The emergency spare wheel is only available in certain countries.

Notes on MOExtended tires (run-flat tires)

⚠ WARNING Risk of accident when driving in limp-home mode

When driving in emergency mode the handling characteristics are impaired.

- ▶ Do not exceed the specified maximum speed of the MOExtended tires.
- ▶ Avoid any abrupt steering and driving maneuvers as well as driving over obstacles (curbs, pot holes, off-road). This applies, in particular, to a loaded vehicle.
- ▶ Stop driving in the emergency mode if you notice:
 - Banging noise

- Vehicle vibration
- Smoke which smells like rubber
- Continuous ESP® intervention
- Cracks in the tire side walls

- ▶ After driving in emergency mode, have the rims checked by a qualified specialist workshop with regard to their further use.
- ▶ The defective tire must be replaced in every case.

With MOExtended tires (run-flat tires), you can continue to drive your vehicle even if there is a total loss of pressure in one or more tires. However, the tire affected must not show any clearly visible damage.

You can recognize MOExtended tires by the MOExtended marking which appears on the side wall of the tire.

Vehicles with tire pressure monitoring system: MOExtended tires may only be used in conjunction with an activated tire pressure monitoring system.

If a pressure loss warning message appears in the driver's display, proceed as follows:

- Check the tire for damage.
- If driving on, observe the following notes.

Driving distance possible in emergency mode after the pressure loss warning:

Load condition	Driving distance possible in emergency mode
Partially laden	50 miles (80 km)
Fully laden	19 miles (30 km)

The driving distance possible in emergency mode may vary depending on the driving style. Observe the maximum permissible speed of 50 mph (80 km/h).

If a tire has been punctured and cannot be replaced with an MOExtended tire, you can use a standard tire as a temporary measure.

TIREFIT kit storage location

Depending on the vehicle's equipment, the storage bag for the TIREFIT kit is located in the cargo compartment or on the left side of the stowage net. Comply with the loading guidelines (→ page 134).

Using the TIREFIT kit

Requirements:

- Tire sealant bottle and tire inflation compressor (→ page 353)
- TIREFIT sticker
- Gloves (depending on the vehicle equipment)

You can use TIREFIT tire sealant to seal perforation damage of up to 0.16 in (4 mm), particularly those in the tire contact surface. You can use TIREFIT in outside temperatures down to -4 °F (-20 °C).

⚠ WARNING Risk of accident when using tire sealant

The tire sealant may be unable to seal the tire properly, especially in the following cases:

- There are large cuts or punctures in the tire (larger than damage previously mentioned)
 - The wheel rims have been damaged
 - After journeys with very low tire pressure or with flat tires
- ▶ Do not continue driving.
- ▶ Consult a qualified specialist workshop.

⚠ WARNING Risk of injury and poisoning from tire sealant

The tire sealant is harmful and causes irritation. Do not allow it to come into contact with the skin, eyes or clothing, and do not swallow it. Do not inhale tire sealant fumes. Keep the tire sealant away from children.

If you come into contact with the tire sealant, observe the following:

- ▶ Rinse off the tire sealant from your skin immediately using water.
- ▶ If tire sealant gets into your eyes, thoroughly rinse out the eyes using clean water.
- ▶ If tire sealant has been swallowed, immediately rinse out the mouth thoroughly and drink plenty of water. Do not induce vomiting and seek medical attention immediately.
- ▶ Change out of any clothes contaminated with tire sealant immediately.
- ▶ If allergic reactions occur, seek medical attention immediately.

NOTE Overheating due to the tire inflation compressor running too long

- ▶ Do not run the tire inflation compressor for longer than ten minutes without interruption.

Comply with the manufacturer's safety notes on the sticker on the tire inflation compressor.

Have the tire sealant bottle replaced in a qualified specialist workshop every five years.

- ▶ Do not remove any foreign objects which have entered the tire.

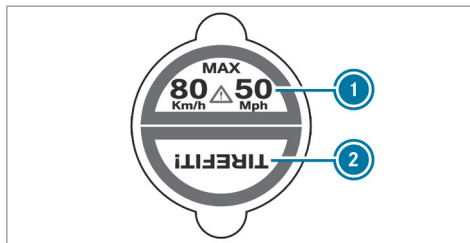

- ▶ Affix part ① of the TIREFIT sticker to the instrument cluster within the driver's field of vision.
- ▶ Affix part ② of the TIREFIT sticker near the valve on the wheel with the faulty tire.

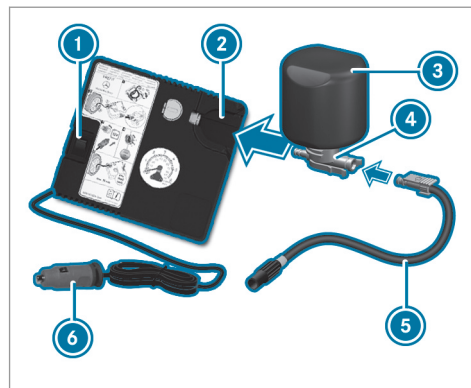

- ▶ Pull plug ⑥ with the cable and hose ⑤ out of the tire inflation compressor housing.
- ▶ Push the plug of hose ⑤ into flange ④ of tire sealant bottle ③ until the plug engages.
- ▶ Place tire sealant bottle ③ head down into recess ② of the tire inflation compressor.



- ▶ Remove the valve cap from valve ⑦ on the faulty tire.
- ▶ Screw filling hose ⑧ onto valve ⑦.
- ▶ Insert plug ⑥ into a 12 V socket in your vehicle.
- ▶ Switch on the ignition.
- ▶ Switch on the tire inflation compressor using On/Off switch ①.
The tire is inflated. First, tire sealant is pumped into the tire. The pressure may briefly rise to approximately 500 kPa (5 bar/73 psi).

Do not switch off the tire inflation compressor during this phase!

- ▶ Let the tire inflation compressor run for a maximum of ten minutes.
The tire should then have attained a tire pressure of at least 200 kPa (2.0 bar/29 psi).

If tire sealant leaks out, make sure you clean the affected area as quickly as possible. It is preferable to use clean water.

If you get tire sealant on your clothing, have it cleaned as soon as possible with perchloroethylene.

If, after ten minutes, a tire pressure of 200 kPa (2.0 bar/29 psi) has not been attained:

- ▶ Switch off the tire inflation compressor.
- ▶ Unscrew the filling hose from the valve of the faulty tire.

Please note that tire sealant may leak out when unscrewing the filling hose.

- ▶ Drive forwards or in reverse very slowly for approximately 33 ft (10 m).

- ▶ Pump up the tire again.
After a maximum of ten minutes the tire pressure must be at least 200 kPa (2.0 bar/29 psi).

⚠ WARNING Risk of accident due to the specified tire pressure not being achieved

If the specified tire pressure is not achieved after the specified time, the tire is too badly damaged. The tire sealant cannot repair the tire in this instance.

The braking characteristics as well as the driving characteristics may be greatly impaired.

- ▶ Do not continue driving.
- ▶ Consult a qualified specialist workshop.

If, after ten minutes, a tire pressure of 200 kPa (2.0 bar/29 psi) has been attained:

- ▶ Switch off the tire inflation compressor.
- ▶ Unscrew the filling hose from the valve of the faulty tire.

⚠ WARNING Risk of accident from driving with sealed tires

A tire temporarily sealed with tire sealant impairs the handling characteristics and is not suitable for higher speeds.

- ▶ Adapt your driving style accordingly and drive carefully.
- ▶ Do not exceed the maximum speed limit with a tire that has been repaired using tire sealant.

- ▶ Observe the maximum permissible speed for a tire sealed with tire sealant 50 mph (80 km/h).

ℹ NOTE Staining caused by leaking tire sealant

After use, excess tire sealant may leak out from the filling hose.

- ▶ Therefore, place the filling hose in the plastic bag that contained the TIREFIT kit.

🔥 ENVIRONMENTAL NOTE Environmental pollution caused by environmentally irresponsible disposal

Tire sealant contains pollutants.

- ▶ Have the tire sealant bottle disposed of professionally, e.g. at an authorized Mercedes-Benz Center.

- ▶ Store the tire sealant bottle and the tire inflation compressor.
- ▶ Pull away immediately.
- ▶ Stop driving after approximately ten minutes and check the tire pressure using the tire inflation compressor.
The tire pressure must now be at least 130 kPa (1.3 bar/ 19 psi).

⚠ WARNING Risk of accident due to the specified tire pressure not being attained

If the specified tire pressure is not reached, the tire is too badly damaged. The tire sealant cannot repair the tire in this instance.

The braking and driving characteristics may be greatly impaired.

- ▶ Do not continue driving.
- ▶ Consult a qualified specialist workshop.

In cases such as the one mentioned above, contact an authorized Mercedes-Benz Center. Or call 1-800-FOR-MERCEdes (in the USA) or 1-800-387-0100 (in Canada).

- ▶ Correct the tire pressure if it is still at least 130 kPa (1.3 bar/ 19 psi). See the Tire and Loading Information placard on the B-pillar on the driver's side or the tire pressure table in the fuel filler flap for values.
- ▶ **To increase the tire pressure:** switch on the tire inflation compressor.

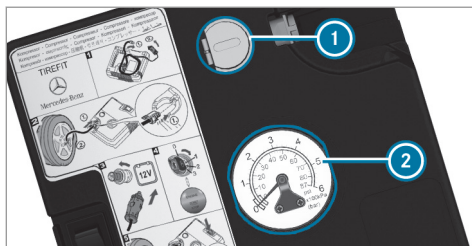

- ▶ **To reduce the tire pressure:** press pressure release button ① next to manometer ②.
- ▶ When the tire pressure is correct, unscrew the filling hose from the valve of the sealed tire.
- ▶ Screw the valve cap onto the valve of the sealed tire.
- ▶ Pull the tire sealant bottle out of the tire inflation compressor.
The filling hose stays on the tire sealant bottle.
- ▶ Drive to the nearest qualified specialist workshop and have the tire, tire sealant bottle and filling hose replaced there.

Battery (vehicle)

Notes on the 12 V battery

⚠ WARNING Risk of an accident due to work carried out incorrectly on the battery

Work carried out incorrectly on the battery can, for example, lead to a short circuit. This can restrict functions relevant for safety systems and impair the operating safety of your vehicle.

You could lose control of the vehicle in the following situations in particular:

- When braking
- In the event of abrupt steering maneuvers and/or when the vehicle's speed is not adapted to the road conditions
- ▶ In the event of a short circuit or a similar incident, contact a qualified specialist workshop immediately.
- ▶ Do not drive on.

▶ Always have work on the battery carried out at a qualified specialist workshop.

- Further information on ABS (→ page 220)
- Further information on ESP® (→ page 221)

For safety reasons, Mercedes-Benz recommends that you only use batteries which have been tested and approved for your vehicle by Mercedes-Benz.

All vehicles except vehicles with a lithium-ion battery

⚠ WARNING Risk of explosion due to electrostatic charge

Electrostatic charge can ignite the highly explosive gas mixture in the battery.

- ▶ To discharge any electrostatic charge that may have built up, touch the metal vehicle body before handling the battery.

The highly flammable gas mixture is created while the battery is charging and during starting assistance.

⚠ WARNING Danger of chemical burns from the battery acid

Battery acid is caustic.

- ▶ Avoid contact with the skin, eyes or clothing.
- ▶ Do not lean over the battery.
- ▶ Do not inhale battery gases.
- ▶ Keep children away from the battery.
- ▶ Immediately rinse battery acid off thoroughly with plenty of clean water and seek medical attention immediately.

All vehicles



ENVIRONMENTAL NOTE Environmental damage due to improper disposal of batteries



Batteries contain pollutants. It is illegal to dispose of them with the household rubbish.



Dispose of batteries in an environmentally responsible manner. Take discharged batteries to a qualified specialist workshop or to a collection point for used batteries.

If you have to disconnect the 12 V battery, contact a qualified specialist workshop.

Comply with safety notes and take protective measures when handling batteries.



Risk of explosion.



Fire, open flames and smoking are prohibited when handling the battery. Avoid creating sparks.



Electrolyte or battery acid is corrosive. Avoid contact with the skin, eyes or clothing. Wear suitable protective clothing, in particular gloves, an apron and a face mask. Immediately rinse electrolyte or acid splashes off with clean water. Consult a doctor if necessary.



Wear safety glasses.



Keep children away.



Observe this Operator's Manual.

Observe the following if you do not intend to use the vehicle over an extended period of time:

- Activate standby mode.
- Alternatively: connect the battery to a battery charger approved by Mercedes-Benz or consult a qualified specialist workshop to disconnect the battery.

Notes on starting assistance and charging the 12 V battery

Vehicles with a lithium-ion battery

When charging the battery and during starting assistance, always use the jump-start connection point in the engine compartment.

! **NOTE** Damage to the battery from over-voltage

When charging using a battery charger without a maximum charging voltage, the battery or the on-board electronics may be damaged.

- ▶ Only use battery chargers with a maximum charging voltage of 14.8 V.

All other vehicles

When charging the battery and during starting assistance, always use the jump-start connection point in the engine compartment.

! **NOTE** Damage to the battery from over-voltage

When charging using a battery charger without a maximum charging voltage, the battery or the on-board electronics may be damaged.

- ▶ Only use battery chargers with a maximum charging voltage of 14.8 V.

! **WARNING** Risk of explosion from hydrogen gas igniting

There is a danger of hydrogen gas igniting when charging the battery if there is a short circuit or sparks start to form.

- ▶ Make sure that the positive terminal of the connected battery does not come into contact with vehicle parts.
- ▶ Never place metal objects or tools on a battery.
- ▶ The described order of the battery clamps must be observed when connecting and disconnecting the battery.
- ▶ When giving starting assistance, always make sure that you only connect battery terminals with identical polarity.
- ▶ During starting assistance, you must observe the described order for connecting and disconnecting the jumper cable.
- ▶ Do not connect or disconnect the battery clamps while the engine is running.

▲ WARNING Risk of explosion during charging process and starting assistance

During the charging process and starting assistance, the battery may release an explosive gas mixture.

- ▶ Avoid fire, open flames, creating sparks and smoking.
- ▶ Make sure there is sufficient ventilation.
- ▶ Do not lean over a battery.

▲ WARNING Risk of explosion from a frozen battery

A discharged battery may freeze at temperatures slightly above or below freezing point.

During starting assistance or battery charging, battery gas can be released.

- ▶ Always allow a battery to thaw before charging it or performing starting assistance.

If the indicator/warning lamps in the instrument cluster do not light up at low temperatures, it is very likely that the discharged battery has frozen. In this case you may neither jump-start the vehicle nor charge the battery.

The service life of a battery that has been thawed may be dramatically shortened. The starting characteristics may be impaired, especially at low temperatures.

It is recommended that you have a thawed battery checked at a qualified specialist workshop.

All vehicles

! NOTE Damage caused by numerous or extended attempts to start the engine

Numerous or extended attempts to start the engine may damage the catalytic converter due to non-combusted fuel.

- ▶ Avoid numerous and extended attempts to start the engine.

Observe the following points during starting assistance and when charging the battery:

- Only use undamaged jumper cables/charging cables with a sufficient cross-section and insulated terminal clamps.
- Non-insulated parts of the terminal clamps must not come into contact with other metal parts while the jumper cable/charging cable is connected to the battery/jump-start connection point.
- The jumper cable/charging cable must not come into contact with any parts which may move when the engine is running.
- Always make sure that neither you nor the battery is electrostatically charged.
- Keep away from fire and open flames.
- Do not lean over the battery.

Observe the additional following points when charging the battery:

- Only use battery chargers tested and approved for Mercedes-Benz.
- Read the battery charger's operating instructions before charging the battery.

Observe the additional following points during starting assistance:

- Starting assistance may only be provided using vehicles, batteries or other jump start devices with a nominal voltage of 12 V.
- The vehicles must not touch.
- **Vehicles with a gasoline engine:** jump-start the vehicle only when the engine and exhaust system are cold.

Starting assistance and charging the 12 V battery

Preparing for starting assistance/the charging process

- ▶ Secure the vehicle by applying the electric parking brake.
- ▶ Select transmission position **P**.
- ▶ Switch off the ignition and all electrical consumers.
- ▶ Open the hood.

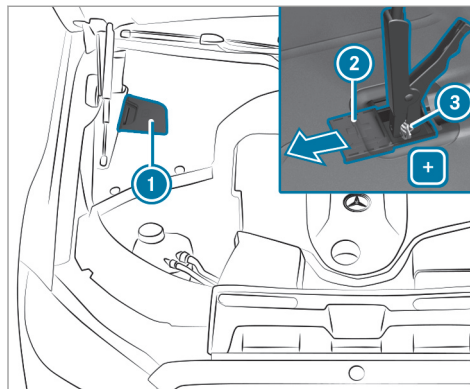

- ▶ Open cover ①.
- ▶ Slide protective cover ② of positive contact ③ on the jump-start connection point in the direction of the arrow.

Starting assistance

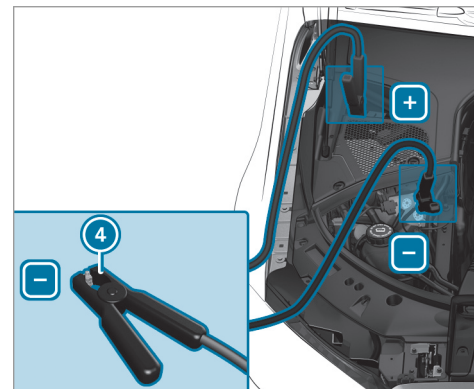

- ▶ Connect the positive contacts of the vehicles with the jumper cable. Start with your own vehicle first.
- ▶ Start the engine of the donor vehicle and run it at idling speed.
- ▶ Connect negative terminal ④ of the donor battery to the ground point of your vehicle

using the jumper cable. Start with the donor vehicle first.

- ▶ Start the engine of your own vehicle.
- ▶ Let the engines run for several minutes.
- ▶ Before disconnecting the jumper cables, switch on an electrical consumer in your own vehicle, e.g. the rear window heater or the lighting.

When starting assistance has finished:

- ▶ First, remove the jumper cable from the ground point of your own vehicle and the negative terminal of the donor battery, then remove the jumper cable from the positive contacts of both vehicles. Always start with your own vehicle first.
- ▶ Close protective cover ② of positive contact ③ and close cover ①.

Further information can be obtained at a qualified specialist workshop.

Charging the 12 V battery

- ▶ Connect the positive contacts of the vehicle and the charger with the charging cable. Start with the vehicle first.
- ▶ Connect the negative contact of the charger and ground point ④ on the vehicle with the charging cable. Start with the charger first.
- ▶ Start the charging process.

When the charging process is complete:

- ▶ Remove the charging cable from ground point ④ on the vehicle and the negative contact of the charger first and then from the positive contacts on the vehicle and charger. Always start with the vehicle first.
- ▶ Close protective cover ② of positive contact ③ and close cover ①.

Replacing the 12 V battery

- ▶ Observe the notes on the 12 V battery (→ page 357).

Mercedes-Benz recommends that you have the 12 V battery replaced at a qualified specialist

workshop, e.g. at an authorized Mercedes-Benz Center.

Observe the following notes if you want to replace the battery yourself:

- Always replace a faulty battery with a battery which meets the specific vehicle requirements.
The vehicle is equipped with an AGM technology battery (Absorbent Glass Mat) or a lithium-ion battery. Full vehicle functionality is only guaranteed with an AGM battery or lithium-ion battery. For safety reasons, Mercedes-Benz recommends that you only use batteries which have been tested and approved for your vehicle by Mercedes-Benz.
- Carry over detachable parts, such as vent hoses, elbow fittings or terminal covers from the battery being replaced.
- Make sure that the vent hose is always connected to the original opening on the side of the battery.
Install any existing or supplied cell caps.
Otherwise, gases or battery acid could escape.

- Make sure that detachable parts are reconnected in the same way.

Tow starting or towing away

Permitted towing methods

! NOTE Damage from automatic braking

If one of the following functions is switched on, the vehicle brakes automatically in certain situations:

- Active Brake Assist
- Active Distance Assist DISTRONIC
- HOLD function
- Active Parking Assist

To avoid damage to the vehicle, deactivate these systems in the following or similar situations:

- ▶ During towing
- ▶ In a car wash

Mercedes-Benz recommends transporting your vehicle in the case of a breakdown, rather than towing it away.

For towing, use a tow rope or tow bar with both axles on the ground. Do not use tow bar systems (→ page 279).

! NOTE Damage to the vehicle due to towing away incorrectly

- ▶ Observe the instructions and notes on towing away.

Towing with a raised axle: towing should be performed by a towing company.

Vehicles with rear wheel drive

Permitted towing methods

Both axles on the ground	Yes, maximum 31 miles (50 km) at 31 mph (50 km/h)
Front axle raised	No
Rear axle raised	Yes, if the steering wheel is fixed in the center position with a steering wheel lock

4MATIC vehicles

Permitted towing methods

Both axles on the ground	Yes, maximum 31 miles (50 km) at 31 mph (50 km/h)
Front axle raised	No
Rear axle raised	No

Towing the vehicle with both axles on the ground

- ▶ Observe the notes on the permitted towing methods (→ page 363).
- ▶ Make sure that the battery is connected and charged.

When the battery is discharged, the following actions cannot be performed:

- The engine cannot be started
 - The electric parking brake cannot be released or applied
 - The automatic transmission cannot be shifted to position **N** or **P**
- i** If the automatic transmission cannot be shifted to position **N** or the driver's display in the instrument cluster does not show anything, have the vehicle transported (→ page 365). A towing vehicle with lifting equipment is required for vehicle transportation.

! **NOTE** Damage due to towing away at excessively high speeds or over long distances

The drivetrain could be damaged when towing at excessively high speeds or over long distances.

- ▶ A towing speed of 30 mph (50 km/h) must not be exceeded.
- ▶ A towing distance of 30 miles (50 km) must not be exceeded.

! **WARNING** Risk of accident when towing a vehicle which is too heavy

If the vehicle to be tow-started or towed away is heavier than the permissible gross mass of your vehicle, the following situations can occur:

- The towing eye may become detached.
 - The vehicle/trailer combination may swerve or rollover.
- ▶ Before tow-starting or towing away, check if the vehicle to be tow-started or

towed away exceeds the permissible gross mass.

If a vehicle must be tow-started or towed away, its weight must not exceed the permissible gross mass of the towing vehicle.

- ▶ Information on the permissible gross mass of the vehicle can be found on the vehicle identification plate (→ page 492).
- ▶ Do not open the driver's door or front passenger door; the automatic transmission will otherwise automatically shift to position **P**.
- ▶ Install the towing eye (→ page 368).
- ▶ Fasten the towing device.

! **NOTE** Damage due to incorrect connection of the tow bar

- ▶ Only connect the tow rope or tow bar to the towing eyes.

- ▶ Deactivate the automatic locking mechanism .

- ▶ Do not activate the HOLD function.
- ▶ Deactivate the tow-away alarm (→ page 104).
- ▶ Deactivate Active Brake Assist (→ page 244).
- ▶ Shift the automatic transmission to position **N**.
- ▶ Release the electric parking brake.

⚠ WARNING Risk of accident due to limited safety-related functions during the towing process

Safety-related functions are limited or no longer available in the following situations:

- The ignition is switched off.
- The brake system or power steering system is malfunctioning.
- The energy supply or the on-board electrical system is malfunctioning.

When your vehicle is towed away, significantly more effort may be required to steer and brake than is normally required.

- ▶ Use a tow bar.
- ▶ Make sure that the steering wheel can move freely before towing the vehicle away.

! **NOTE** Damage due to excessive tractive power

If you pull away sharply, the tractive power may be too high and the vehicles could be damaged.

- ▶ Pull away slowly and smoothly.

Loading the vehicle for transport

Requirements:

- The vehicle is stationary.
- The engine is switched off.
- The driver display is in the initial state with no menus open (→ page 280). Transport is also possible with a warning message visible.
- The 12 V battery is charged.

- ▶ If necessary, set the system language (→ page 306).
- ▶ Observe the notes on towing away (→ page 364).
- ▶ Connect the towing device to the towing eye in order to load the vehicle.
- ▶ Switch on the power supply (→ page 189).
- ▶ Shift the automatic transmission to position **N**.
- ⓘ The automatic transmission may be locked in position **P** in the event of damage to the electrics. To shift to **N**, provide the on-board electrical system with power (→ page 361).

! **NOTE** Possible damage to the vehicle when loading or unloading

When loading or unloading, the vehicle must be raised to transport level.

If the transport settings are not shown or the **Vehicle not ready for loading** display message is shown, the vehicle may not be loaded or unloaded.

- ▶ If required, raise the vehicle to transport level again.
- ▶ A vehicle that cannot be raised to transport level may not be loaded or unloaded using a ramp. Consult a qualified specialist workshop.



⚠ WARNING Risk of accident due to activated transport level

When you use transport level, driving and driving safety systems have only limited availability and the view from the vehicle is limited.

Driving safety is severely restricted and there is a risk of an accident!

- ▶ Do not use transport level in normal road operation.
- ▶ Only activate and use transport level when not on public roads.
- ▶ Ensure that no persons or obstacles are located in the area surrounding the vehicle.

Raising the vehicle to transport level

- ▶ Press the button for at least five seconds.
- ▶ Immediately press and hold the button for at least one second. The **Switch vehicle on for transport level** display message appears.
- ▶ Start the engine (→ page 190). The transport settings are displayed.
- ▶ Swipe downward to select **Transport level** and press . The vehicle is raised and the **Vehicle rising** display message is shown for 5 seconds. The

raising process can last up to 60 seconds and can be canceled with the button.

- ▶ When raising, do not switch off the engine.

While the vehicle is being raised, you can maneuver at a maximum speed of 25 mph (40 km/h).



- ▶ Wait to load until transport level has been reached and the **Transport level** status is shown.

i If the vehicle is raised to transport level, the transport settings will continue to be shown even after a restart. Operation of the driver display is meanwhile restricted.

When the vehicle is at transport level, it is lowered again in the following situations:

- When driven faster than 25 mph (40 km/h).
- The 12 V battery is discharged.



The vehicle is adjusted to the height of the last active level.

Transporting the vehicle

- ▶ Load the vehicle onto the transporter.
- ▶ Shift the automatic transmission to position **P**.
- ▶ Use the electric parking brake to secure the vehicle against rolling away.

- ▶ Switch off the engine and the power supply.
- ▶ Only secure the vehicle by the wheels.

4MATIC vehicles

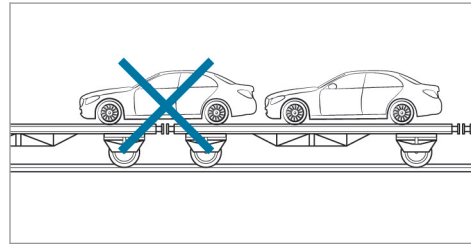

- ▶ Make sure that the front and rear axles come to rest on the same transportation vehicle.

! **NOTE** Damage to the drive train due to incorrect positioning of the vehicle

- ▶ Do not position the vehicle above the connection point of the transport vehicle.

Unloading the vehicle

- ▶ Make sure that the vehicle is raised to transport level before unloading (→ page 365).

Lowering the vehicle after unloading

- ▶ Switch on the power supply.
- ▶ Start the engine.
- ▶ Swipe upward in the transport settings to select **Standard level** and press **[OK]**. The vehicle is set to the height of the last active level and the **Vehicle lowering** display message is shown.
- ▶ After the vehicle has been lowered, press the **[↶]** button for at least two seconds. The transport settings are closed.

Towing eye storage location

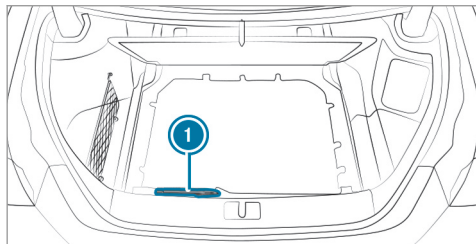

Towing eye ① is located under the trunk floor. Depending on the vehicle equipment, the towing eye may be located at another position in the trunk.

Installing the towing eye

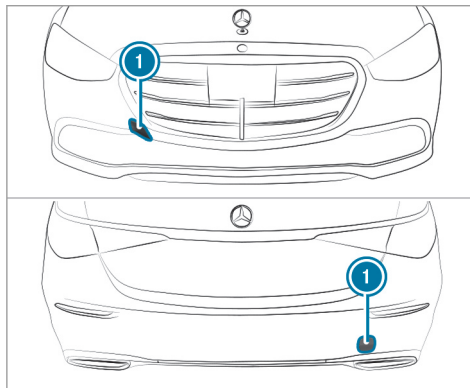

- ▶ Press the mark on cover ① inwards and remove.
- ▶ Screw in the towing eye clockwise as far as it will go and tighten.
- ▶ Make sure that cover ① engages in the bumper when you remove the towing eye.

! **NOTE** Damage to the vehicle due to incorrect use of the towing eye or trailer hitch

When a towing eye or trailer hitch is used to recover a vehicle, the vehicle may be damaged in the process.

- ▶ Only use the towing eye or trailer hitch to tow away or tow start the vehicle.
- ▶ Do not use the towing eye or trailer hitch to tow the vehicle during recovery.

Tow-starting the vehicle (emergency engine start)

! **NOTE** Damage to the automatic transmission due to tow-starting

Tow-starting the vehicle can damage the automatic transmission.

- ▶ Do not tow-start the vehicle.

- ▶ Do not tow-start the vehicle.

Electrical fuses

Notes on electrical fuses

⚠ WARNING Risk of accident and injury due to overloaded lines

If you manipulate or bridge a faulty fuse or if you replace it with a fuse with a higher amperage, the electric line could be overloaded.

This could result in a fire.

- ▶ Always replace faulty fuses with specified new fuses containing the correct amperage.

! NOTE Damage due to incorrect fuses

Electrical components or systems may be damaged by incorrect fuses, or their functionality may be significantly impaired.

- ▶ Only use fuses that have been approved by Mercedes-Benz and which have the correct fuse rating.

Blown fuses must be replaced with fuses of the same rating, which you can recognize by the color and fuse rating. The fuse ratings and further information to be observed can be found in the fuse assignment diagram.

Fuse assignment diagram: in the vehicle document wallet.

! NOTE Damage or malfunctions caused by moisture

Moisture may cause damage to the electrical system or cause it to malfunction.

- ▶ When the fuse box is open, make sure that no moisture can enter the fuse box.
- ▶ When closing the fuse box, make sure that the seal of the lid is positioned correctly on the fuse box.

If the newly inserted fuse also blows, have the cause traced and rectified at a qualified specialist workshop.

Ensure the following before replacing a fuse:

- The vehicle is secured against rolling away.

- All electrical consumers are switched off.
- The ignition is switched off.

The electrical fuses are located in the following fuse boxes:

- Fuse box in the engine compartment on the driver's side (→ page 369)
- Fuse box on the driver's side of the cockpit (→ page 371)
- Fuse box in the front passenger footwell (→ page 372)
- Fuse box in the trunk on the right-hand side of the vehicle, when viewed in the direction of travel (→ page 372)

Opening and closing the fuse box in the engine compartment

Requirements:

- Observe the notes on electrical fuses (→ page 369).
- Have the following tools readily available:
 - A dry cloth

- A screwdriver with an appropriate head

Opening

- i Depending on the vehicle equipment, access to the fuse box may be limited. Mercedes-Benz recommends consulting a qualified specialist workshop, e.g. an authorized Mercedes-Benz Center.

⚠ WARNING Risk of injury from using the windshield wipers while the engine hood is open

When the engine hood is open and the windshield wipers are set in motion, you can be trapped by the wiper linkage.

- ▶ Always switch off the windshield wipers and ignition before opening the engine hood.

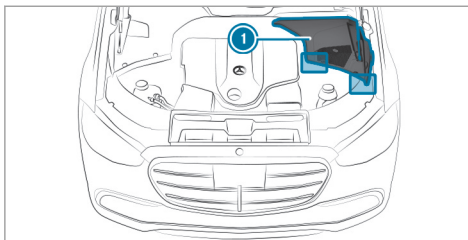

- ▶ Release the rotary catches on cover ① and pull the cover up and out.
- ▶ Remove any existing moisture from the fuse box using a dry cloth.

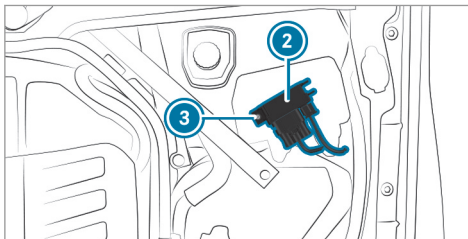

- ▶ Depending on the vehicle equipment, there may be an electrical component ② on the fuse box lid. If present, unscrew screw ③ and put the component to the side without disconnecting the electrical connection.

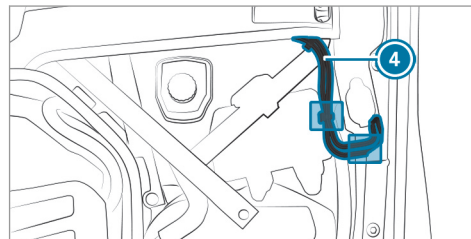

- ▶ If present, release hoses ④ from the retaining clips on the fuse box and vehicle body.

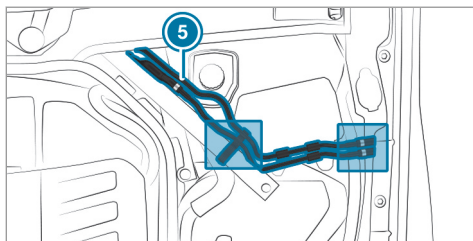

- ▶ If present, release hoses 5 from the retaining clips in the engine compartment and vehicle body.

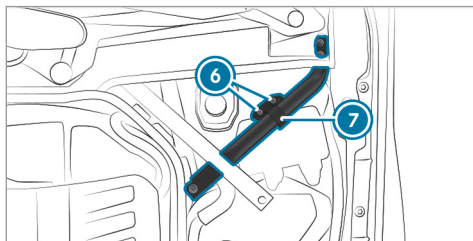

- ▶ Unscrew screws 6 and fold out bar 7.

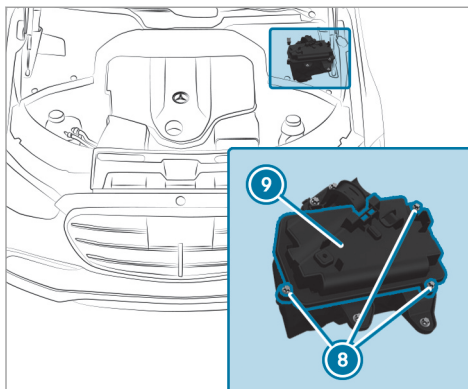

- ▶ Unscrew screws 8 and remove fuse box lid 9 to the side.

Closing

- ▶ Check whether the seal is positioned correctly in lid 9.
- ▶ Place lid 9 on the fuse box and tighten screws 8.
- ▶ Fold back bar 7 and tighten screws 6.

- ▶ If present, engage hoses 5 in the retaining clips in the engine compartment and vehicle body.
- ▶ If present, engage hoses 4 in the retaining clips on the fuse box and vehicle body.
- ▶ If present, insert electrical component 2 into the holder on the fuse box lid and tighten screws 3.
- ▶ Insert cover 1 and engage the rotary catches.

Opening and closing the fuse box in the cockpit

Requirements:

- Observe the notes on electrical fuses (→ page 369).

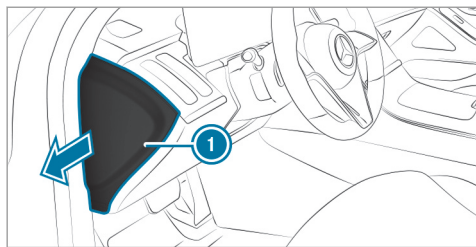

- ▶ Open cover ① in the direction of the arrow and remove it.

Opening and closing the fuse box in the front passenger footwell

Requirements:

- Observe the notes on electrical fuses (→ page 369).

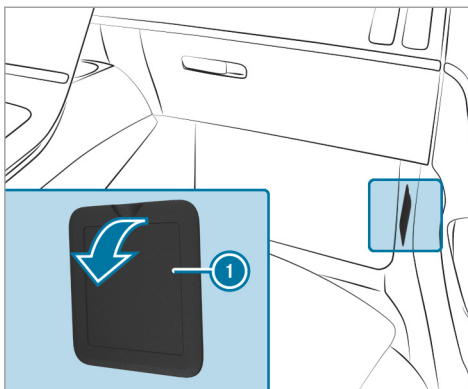

- ▶ Open cover ① in the direction of the arrow and remove it.

Opening and closing the fuse box in the trunk

Requirements:

- Observe the notes on electrical fuses (→ page 369).

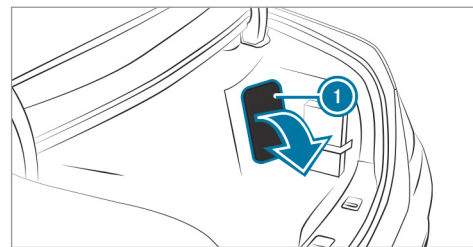

- ▶ Fold cover ① down in the direction of the arrow.

Notes on noise or unusual handling characteristics

Make sure there are no vibrations, noises or unusual handling characteristics when the vehicle is in motion. This may indicate that the wheels or tires are damaged. Hidden tire damage could also be causing the unusual handling characteristics.

If you suspect that a tire is malfunctioning, reduce your speed immediately and have the tires and wheels checked at a qualified specialist workshop.

Notes on regularly inspecting wheels and tires

⚠ WARNING Risk of injury through damaged tires

Damaged tires can cause tire pressure loss.

- ▶ Check the tires regularly for signs of damage and replace any damaged tires immediately.

⚠ WARNING Risk of hydroplaning due to insufficient tire tread

Insufficient tire tread will result in reduced tire grip.

In heavy rain or slush the risk of hydroplaning is increased, in particular where speed is not adapted to suit the conditions.

- ▶ Thus, you should regularly check the tread depth and the condition of the tread across the entire width of all tires.

Minimum tread depth for:

- Summer tires: $\frac{1}{8}$ in (3 mm)
- M+S tires: $\frac{1}{6}$ in (4 mm)
- ▶ For safety reasons, replace the tires before the legally-prescribed limit for the minimum tread depth is reached.

Carry out the following checks on all wheels regularly, at least once a month or as required, for example, prior to a long journey or driving off-road:

- Check the tire pressure (→ page 375).

- Visually inspect wheels and tires for damage.
- Check the valve caps.
- Visual check of the tire tread depth and the tire contact surface across the entire width.

The minimum tread depth for summer tires is $\frac{1}{8}$ in (3 mm) and for winter tires $\frac{1}{6}$ in (4 mm).

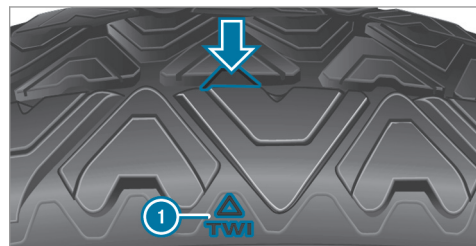

Six marks ① show where the bar indicators (arrow) are integrated into the tire tread. They are visible once a tire tread depth of approximately $\frac{1}{16}$ in (1.6 mm) has been reached.

Notes on snow chains

⚠ WARNING Risk of accident due to incorrect mounting of snow chains

If you have mounted snow chains to the front wheels, the snow chains may drag against the vehicle body or chassis components.

This could cause damage to the vehicle or the tires.

- ▶ Never mount snow chains on the front wheels.
- ▶ Only mount snow chains on the rear wheels in pairs.

! NOTE Damage to components of the vehicle body or chassis due to mounted snow chains

If you mount snow chains to the front wheels of 4MATIC vehicles, you may damage components of the vehicle body or chassis.

- ▶ Only mount snow chains to the rear wheels of 4MATIC vehicles.

Observe the following notes when using snow chains:

- Snow chains are only permissible for certain wheel/tire combinations. You can obtain information about this from an authorized Mercedes-Benz Center.
- For safety reasons, only use snow chains that have been specifically approved for your vehicle by Mercedes-Benz, or snow chains with the same quality standard.
- If snow chains are installed, the maximum permissible speed is 30 mph (50 km/h).
- **Vehicles with Active Parking Assist:** Do not use Active Parking Assist when snow chains are installed.
- **Vehicles with level control:** If snow chains are installed, only drive at raised vehicle level (→ page 257).
- **Vehicles with rear axle steering:** If snow chains are installed, only drive with snow chain mode active (→ page 374).

- ① You can deactivate ESP® to pull away (→ page 222). This allows the wheels to spin, achieving an increased driving force.

Activating or deactivating snow chain mode

Multimedia system:



- ▶ Activate or deactivate [Snow Chain Mode](#).

When the function is active, the vehicle behaves as if snow chains were mounted. For example, the maximum steering movement of the rear wheels is limited.

Additionally, parts of the driving and driving safety systems are not available when snow chain mode is active.

Tire pressure

Notes on tire pressure

⚠ WARNING Risk of accident due to insufficient or excessive tire pressure

Tires with either too low or too high a pressure present the following hazards:

- the tires could burst
 - the tires could wear excessively and/or unevenly
 - the driving characteristics as well as steering and braking characteristics may be severely impaired
- ▶ Observe the recommended tire pressures and check the tire pressure of all tires including the spare wheel:
- monthly
 - if altering the load on the vehicle
 - prior to long journeys
 - if the operating conditions change, for example when driving off-road

- ▶ Adjust the tire pressure where necessary.

Tire pressure which is too high or too low can:

- Shorten the service life of the tires.
- Cause increased tire damage.
- Adversely affect driving characteristics and thus driving safety, e.g. due to hydroplaning.

⚠ WARNING Risk of accident due to too low a tire pressure

Tires with pressure that is too low can overheat and burst as a consequence.

In addition, they also suffer from irregular wear, which can significantly impair the braking properties and the handling characteristics.

- ▶ Avoid excessively low tire pressure.

Tire pressure which is too low can cause:

- Tire malfunctions as a result of overheating
- Impaired handling characteristics
- Irregular wear

- Increased fuel consumption

⚠ WARNING Risk of accident due to too high a tire pressure

Tires with excessively high pressure can burst.

In addition, they also suffer from irregular wear, which can significantly impair the braking properties and the handling characteristics.

- ▶ Avoid excessively high tire pressures.

Tire pressure which is too high can cause:

- Increased braking distance
- Impaired handling characteristics
- Irregular wear
- Impaired driving comfort
- Susceptibility to damage

⚠ WARNING Risk of accident due to repeated pressure drop in the tires

The wheels, valves or tires could be damaged.

Too low a tire pressure can lead to the tires bursting.

- ▶ Examine the tires for foreign objects.
- ▶ Check whether the tire has a puncture or the valve has a leak.
- ▶ If you are unable to rectify the damage, contact a qualified specialist workshop.

You can find information on tire pressure for the vehicle's factory-installed tires on the following labels:

- Tire and Loading Information placard on the B-pillar of your vehicle (→ page 380).
- Tire pressure table on the inside of the fuel filler flap (→ page 376).

Observe the maximum tire pressure (→ page 386).

Use a suitable pressure gauge to check the tire pressure. The outer appearance of a tire does not permit any reliable conclusion about the tire pressure.

Only correct tire pressure when the tires are cold. Conditions for cold tires:

- The vehicle has been parked with the tires out of direct sunlight for at least three hours.
- The vehicle has traveled less than 1 mile (1.6 km).

The vehicle's tires heat up when driving. As the temperature of the tires increases, so too does the tire pressure.

Vehicles with tire pressure monitoring system: You can also see the tire pressure in the driver display.

The tire pressure recommended for increased load/speed in the tire pressure table can affect the ride comfort.

⚠ WARNING Risk of accident due to unsuitable accessories on tire valves

If you mount unsuitable accessories onto tire valves, the tire valves may be overloaded and malfunction, which can cause tire pressure loss.

- ▶ Only screw standard valve caps or valve caps specifically approved by Mercedes-Benz for your vehicle onto the tire valve.

Tire pressure table

The tire pressure table is on the inside of the fuel filler flap.

- ⓘ The data shown in the images is example data.

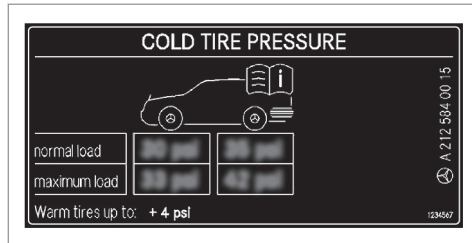

If one or more tire sizes precede a tire pressure, the following tire pressure information is only valid for those tire sizes and their respective load condition.

The load conditions "partially laden" and "fully laden" are defined in the table for different numbers of passengers and amounts of luggage. The actual number of seats may differ from this.

		kPa		psi	
R18	1 passenger				
	2 passengers				
R19	1 passenger				
	2 passengers				
M+S	1 passenger				
	2 passengers				

Some tire pressure tables only show the rim diameter instead of the complete tire size, e.g. **R18**. The rim diameter is part of the tire size and can be found on the tire side wall (→ page 387).

- Tire and Loading Information placard (→ page 380)
- Maximum tire pressure (→ page 386)

Checking the tire pressure manually

- ▶ Read the tire pressure recommended for the current operating conditions from the Tire and Loading Information placard or the tire pressure table. Observe the notes on tire pressure.
- ▶ Remove the valve cap of the tire to be checked.
- ▶ Press the tire pressure gauge securely onto the valve.
- ▶ Read the tire pressure.
- ▶ If the tire pressure is lower than the recommended value, increase the tire pressure to the recommended value.
- ▶ If the tire pressure is higher than the recommended value, release air. To do so, press down the metal pin in the valve, e.g. using the tip of a pen, for example. Then check the tire pressure again using the tire pressure gauge.
- ▶ Screw the valve cap onto the valve.

Further related subjects:

- Notes on tire pressure (→ page 375)

- Tire pressure table (→ page 376)
- Tire and Loading Information placard (→ page 380)

Tire pressure monitoring system

Function of the tire pressure monitoring system

⚠ DANGER Risk of accident due to incorrect tire pressure

Each tire, including the spare (if provided), should be checked monthly when cold and inflated to the inflation pressure recommended by the vehicle manufacturer on the vehicle placard or tire inflation pressure label. (If your vehicle has tires of a different size than the size indicated on the vehicle placard or tire inflation pressure label, you should determine the proper tire inflation pressure for those tires.)

As an added safety feature, your vehicle has been equipped with a tire pressure monitoring system (TPMS) that illuminates a low tire

pressure telltale when one or more of your tires is significantly under-inflated. Accordingly, when the low tire pressure telltale illuminates, you should stop and check your tires as soon as possible, and inflate them to the proper pressure. Driving on a significantly under-inflated tire causes the tire to overheat and can lead to tire failure. Under-inflation also reduces fuel efficiency and tire tread life, and may affect the vehicle's handling and stopping ability. Please note that the TPMS is not a substitute for proper tire maintenance, and it is the driver's responsibility to maintain correct tire pressure, even if under-inflation has not reached the level to trigger illumination of the TPMS low tire pressure telltale.

Your vehicle has also been equipped with a TPMS malfunction indicator to indicate when the system is not operating properly. The TPMS malfunction indicator is combined with the low tire pressure telltale. When the system detects a malfunction, the telltale will flash for approximately one minute and then

remain continuously illuminated. This sequence will continue upon subsequent vehicle start-ups as long as the malfunction exists.

When the malfunction indicator is illuminated, the system may not be able to detect or signal low tire pressure as intended. TPMS malfunctions may occur for a variety of reasons, including the installation of replacement or alternate tires or wheels on the vehicle that prevent the TPMS from functioning properly.

The system checks the tire pressure and the tire temperature of the tires installed on the vehicle by means of a tire pressure sensor.

The tire pressure and the tire temperature appear in the driver display (→ page 379).

If there is a substantial pressure loss or if the tire temperature is excessive, you will be warned with display messages (→ page 555) or the  warning lamp in the instrument cluster (→ page 577).

The tire pressure monitoring system is only an aid. It is the driver's responsibility to set the tire pressure to the recommended cold tire pressure suitable for the operating situation.

In most cases, the tire pressure monitoring system will automatically update the new reference values after you have changed the tire pressure. You can, however, also update the reference values by restarting the tire pressure monitoring system manually (→ page 379).

System limits

The system may be impaired or may not function particularly in the following situations:

- Incorrect reference values were taught in
- Sudden pressure loss caused by a foreign object penetrating the tire, for example
- There is a malfunction caused by another radio signal source

Checking the tire pressure with the tire pressure monitoring system

Requirements:

- The ignition is switched on.

Driver display:



▶ Select **Tire Pressure** and confirm with **OK**.

One of the following displays appears:

- Current tire pressure of each wheel:



- **Tire pressure displayed after driving for a few minutes.**
- **Tire Pressure Monitor Active:** the teach-in process of the system is not yet complete. The tire pressures are already being monitored.

▶ Compare the tire pressure with the recommended tire pressure for the current operating condition (→ page 376). Additionally, observe the notes on cold tires (→ page 375).

ⓘ The values displayed in the driver display may deviate from those of the tire pressure gauge as they refer to sea level. At high elevations, the tire pressure values indicated by a tire pressure gauge are higher than those shown by the driver display. In this case, do not reduce the tire pressure.

Bear in mind the following related topic:

- Notes on tire pressure (→ page 375)

Restarting the tire pressure monitoring system

Requirements:

- The recommended tire pressure is correctly set for the respective operating status on each of the four wheels (→ page 375).

Restart the tire pressure monitoring system in the following situations:

- The tire pressure has been changed.

- The wheels or tires have been changed or newly installed.

Driver display:



- ▶ Select **Tire Pressure** and confirm with **OK**.
- ▶ Swipe down on Touch Control on the steering wheel.
The driver display shows the **Use current pressures as new reference values?** message.
- ▶ Select **Yes** and confirm the restart with **OK**.
The driver display shows the **Tire Pressure Monitor Restarted** message.
Current warning messages are deleted and the yellow  warning lamp goes out.
After you have been driving for a few minutes, the system checks whether the current tire pressures are within the specified range. The current tire pressures are then accepted as reference values and monitored.

Bear in mind the following related topic:

- Notes on tire pressure (→ page 375)

Loading the vehicle

Notes on Tire and Loading Information placard

⚠ WARNING Risk of accident from overloaded tires

Overloaded tires may overheat and burst as a consequence. Overloaded tires can also impair the steering and handling characteristics and lead to brake failure.

- ▶ Observe the load rating of the tires.
- ▶ The load rating must be at least half the permissible axle load of the vehicle.
- ▶ Never overload the tires by exceeding the maximum load.

The Tire and Loading Information placard is on the B-pillar on the driver's side of the vehicle.

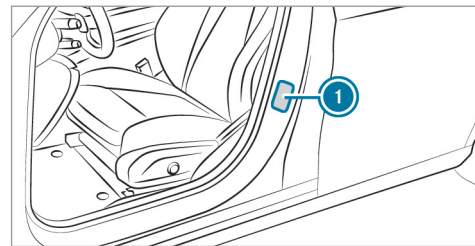

① Tire and Loading Information placard

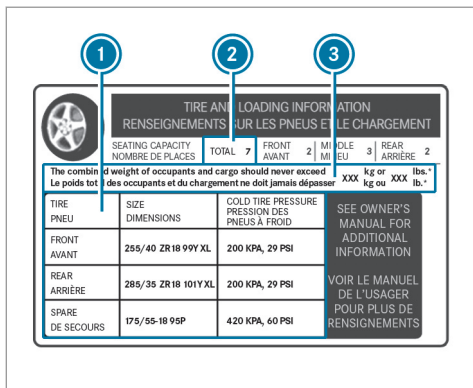

i The data shown in the illustration is example data.

The Tire and Loading Information placard shows the following information:

- Maximum number of seats **2** according to the maximum number of people permitted to travel in the vehicle.

- Maximum permissible load **3** comprises the gross weight of all vehicle occupants, load and luggage.
- Recommended tire pressure **1** for cold tires. The recommended tire pressures are valid for the maximum permissible load and up to the maximum permissible vehicle speed.

Please also note:

- Information on permissible weights and loads on the vehicle identification plate (→ page 492).
- Information on tire pressure in the tire pressure table (→ page 376).

Further related subjects:

- Determining the maximum permissible load (→ page 381)
- Notes on tire pressure (→ page 375).

Steps for Determining Correct Load Limit

The following steps have been developed as required of all manufacturers under Title 49,

Code of U.S. Federal Regulations, Part 575, pursuant to the "National Traffic and Motor Vehicle Safety Act of 1966".

- ▶ **(1):** Locate the statement "The combined weight of occupants and cargo should never exceed XXX kg or XXX lbs." on your vehicle's placard.
- ▶ **(2):** Determine the combined weight of the driver and passengers that will be riding in your vehicle.
- ▶ **(3):** Subtract the combined weight of the driver and passengers from XXX kg or XXX lbs.
- ▶ **(4):** The resulting figure equals the available amount of cargo and luggage load capacity. For example, if the "XXX" amount equals 1,400 lbs. and there will be five 150 lb passengers in your vehicle, the amount of available cargo and luggage load capacity is 650 lbs. (1,400 - 750 (5 x 150) = 650 lbs.)
- ▶ **(5):** Determine the combined weight of luggage and cargo being loaded on the vehicle. That weight may not safely exceed the available

ble cargo and luggage load capacity calculated in Step 4.

- ▶ **(6):** If your vehicle will be towing a trailer, load from your trailer will be transferred to your vehicle. Consult this manual to determine how this reduces the available cargo and luggage load capacity of your vehicle.
- ⓘ Not all vehicles are permitted to tow a trailer. Towing a trailer is only permitted if a trailer-hitch is installed. Please consult an authorized Mercedes-Benz dealer if you have any questions about towing a trailer with your vehicle.

Even if you have calculated the total load carefully, you should still make sure that the maximum permissible gross weight and the maxi-

imum gross axle weight rating of your vehicle are not exceeded. Details can be found on the vehicle identification plate.

- ▶ Have your loaded vehicle – including driver, occupants and load – weighed on a vehicle weighbridge. The measured values may not exceed the maximum permissible values stated on the vehicle identification plate.

Further related subjects:

- Calculation example for determining the maximum load (→ page 382)
- Tire and Loading Information placard (→ page 380)
- Tire pressure table (→ page 376)

- Vehicle identification plate (→ page 492)

Calculation example for determining the maximum load

The following table shows examples of how to calculate total and load capacities with varying seating configurations and different numbers and sizes of occupants. The following examples use a maximum load of 1500 lbs (680 kg). **This is for illustration purposes only.** Make sure you are using the actual load limit for your vehicle stated on your vehicle's Tire and Loading Information placard (→ page 380).

The higher the weight of all the occupants, the smaller the maximum load for luggage.

Step 1

	Example 1	Example 2
Combined maximum weight of occupants and load (data from the Tire and Loading Information placard)	1500 lbs (680 kg)	1500 lbs (680 kg)

Step 2

	Example 1	Example 2
Number of people in the vehicle (driver and occupants)	5	1
Distribution of the occupants	Front: 2 Rear: 3	Front: 1
Weight of occupants	Occupant 1: 150 lbs (68 kg) Occupant 2: 180 lbs (82 kg) Occupant 3: 160 lbs (73 kg) Occupant 4: 140 lbs (63 kg) Occupant 5: 120 lbs (54 kg)	Occupant 1: 200 lbs (91 kg)
Total weight of all occupants	750 lbs (340 kg)	200 lbs (91 kg)

Step 3

	Example 1	Example 2
Permissible load (maximum gross vehicle weight rating from the Tire and Loading Information placard minus the gross weight of all occupants)	$1500 \text{ lbs (680 kg)} - 750 \text{ lbs (340 kg)} = 750 \text{ lbs (340 kg)}$	$1500 \text{ lbs (680 kg)} - 200 \text{ lbs (91 kg)} = 1300 \text{ lbs (589 kg)}$

Tire labeling

Overview of tire labeling

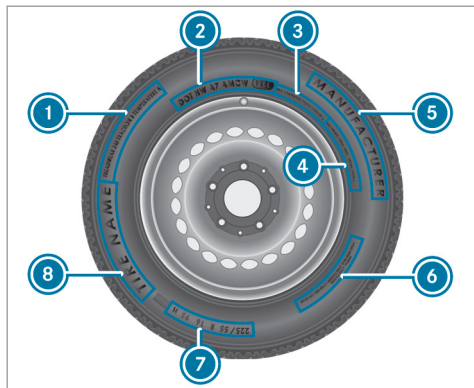

- ① Uniform Tire Quality Grading Standards
- ② DOT (Department of Transportation), (TIN) Tire Identification Number
- ③ Maximum tire load (→ page 386)
- ④ Maximum tire pressure (→ page 386)

- ⑤ Manufacturer
 - ⑥ Tire characteristics (→ page 387)
 - ⑦ Tire size designation, load-bearing capacity, speed rating and load index (→ page 387)
 - ⑧ Tire name
- ① The data shown in the illustration is example data.

Tire Quality Grading

In accordance with the US Department of Transportation's "Uniform Tire Quality Grading Standards", tire manufacturers are required to grade their tires on the basis of the following three performance factors:

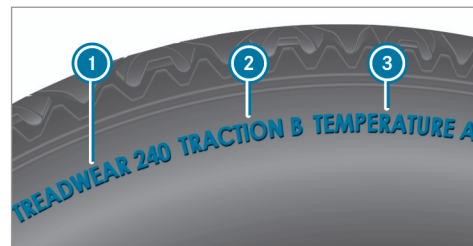

- ① Tread wear grade
 - ② Traction grade
 - ③ Temperature grade
- ① The data shown in the illustration is example data.
- ① The classification is not legally stipulated for Canada, but it is generally stated.

Tread wear grade

The treadwear grade is a comparative rating based on the wear rate of the tire when tested under controlled conditions on a specified government test course. For example, a tire graded 150 would wear one and one-half (1 1/2\)

times as well on the government course as a tire graded 100.

The relative performance of tires depends upon the actual conditions of their use, however, and may depart significantly from the norm due to variations in driving habits, service practices and differences in road characteristics and climate.

Traction grade

⚠ DANGER Risk of accident due to inadequate traction

The traction grade assigned to this tire is based on straight-ahead braking traction tests.

- ▶ Always adapt your driving style and drive at a speed to suit the prevailing traffic and weather conditions.

! NOTE Damage to the drivetrain from wheelspin

- ▶ Avoid wheelspin.

The traction grades, from highest to lowest, are AA, A, B, and C. Those grades represent the tire's ability to stop on wet pavement as measured under controlled conditions on specified government test surfaces of asphalt and concrete. A tire marked C may have poor traction performance.

Temperature grade

⚠ WARNING Risk of accident from tire overheating and tire failure

Excessive speed, underinflation, or excessive loading, either separately or in combination, can cause excessive heat build-up and possible tire failure.

- ▶ Observe the recommended tire pressure.
- ▶ Regularly check the pressure of all the tires.
- ▶ Adjust the tire pressure, if necessary.

The temperature grades are A (the highest), B, and C, representing the tire's resistance to the generation of heat and its ability to dissipate

heat when tested under controlled conditions on a specified indoor laboratory test wheel. Sustained high temperature can cause the material of the tire to degenerate and reduce tire life, and excessive temperature can lead to sudden tire failure. The grade C corresponds to a level of performance which all passenger car tires must meet under the Federal Motor Safety Standard No. 109. Grades B and A represent higher levels of performance on the laboratory test wheel than the minimum required by law.

DOT, Tire Identification Number (TIN)

US tire regulations stipulate that every tire manufacturer or retreader must imprint a TIN in or on the side wall of each tire produced.

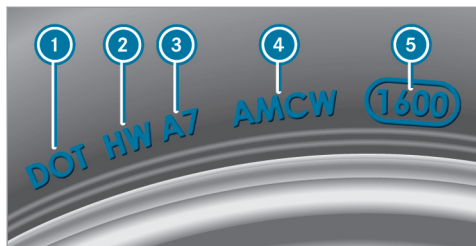

i The data shown in the image is example data.

The TIN is a unique identification number to identify tires and comprises the following:

- **DOT (Department of Transportation):** tire symbol marks **1** indicating that the tire complies with the requirements of the US Department of Transportation.
- **Manufacturer identification code:** manufacturer identification code **2** contains details of the tire manufacturer. New tires have a code with two symbols. Retreaded tires have a code with four symbols. Further information on retreaded tires (→ page 392).

- **Tire size:** identifier **3** describes the tire size.
- **Tire type code:** tire type code **4** can be used by the manufacturer as a code to describe specific characteristics of the tire.
- **Manufacturing date:** manufacturing date **5** provides information about the age of a tire. The 1st and 2nd positions represent the calendar week and the 3rd and 4th positions state the year of manufacture (e.g. "3208" represents the 32nd week of 2008).

Information on the maximum tire load

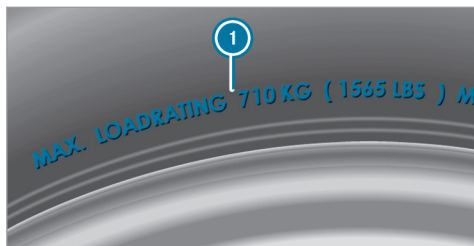

i The data shown in the image is example data.

Maximum tire load **1** is the maximum permissible weight for which the tire is approved.

Do not overload the tires by exceeding the specified load limit. The maximum permissible load can be found on the vehicle's Tire and Loading Information placard on the B-pillar on the driver's side (→ page 380).

Specifications for maximum tire pressure

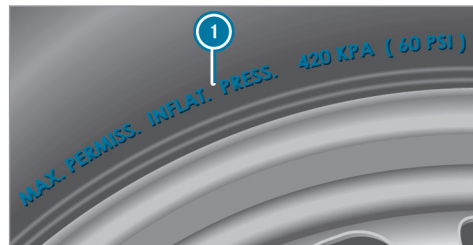

i The data shown in the illustration is example data.

Never exceed maximum tire pressure ❶ specified for the tire. Always observe the recommended tire pressure for your vehicle when adjusting the tire pressure (→ page 376).

Information on tire characteristics



❶ The data shown in the image is example data.

This information describes the type of tire cord and the number of layers in side wall ❶ and under tire tread ❷.

Tire size designation, load-bearing capacity, speed rating and load index

⚠ WARNING Risk of injury through exceeding the specified tire load-bearing capacity or the permissible speed rating

Exceeding the specified tire load rating or the permissible speed rating may lead to tire damage and to the tires bursting.

- ▶ Therefore, only use tire types and sizes approved for your vehicle model.
- ▶ Observe the tire load rating and speed rating required for your vehicle.

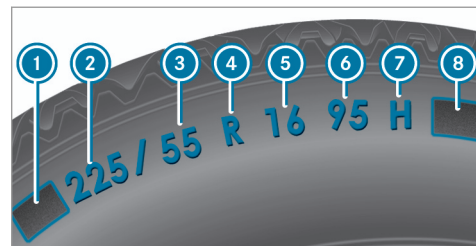

- ❶ First letter(s)
- ❷ Nominal tire width in millimeters
- ❸ Aspect ratio in %
- ❹ Tire code
- ❺ Rim diameter
- ❻ Load-bearing index
- ❼ Speed rating
- ❽ Load index

❶ The data shown in the illustration is example data.

Information about reading tire data can be obtained from any qualified specialist workshop.

First letter(s) ①:

- Without: passenger vehicle tires according to European manufacturing standards.
- "P": passenger vehicle tires according to US manufacturing standards.
- "LT": light truck tires according to US manufacturing standards.
- "T": compact emergency spare wheels with high tire pressure that are only designed for temporary use in an emergency.

Aspect ratio ②:

Ratio between tire height and tire width in percent (tire height divided by tire width).

Tire code ④ (tire type):

- "R" radial tire
- "D": bias ply tire
- "B": bias belted tires
- "ZR": radial tire with a maximum speed above 149 mph (240 km/h) (optional)

Rim diameter ⑤:

The diameter of the bead seat (not the diameter of the rim flange). The rim diameter is specified in inches (in).

Load-bearing index ⑥:

Numerical code that specifies the maximum load-bearing capacity of a tire (e.g. "91" corresponds to 1356 lbs (615 kg)).

The load-bearing capacity of the tire must be at least half the gross axle weight rating of your vehicle. Do not overload the tires by exceeding the specified load limit.

See also:

- Maximum permissible load on the Tire and Loading Information placard (→ page 380)
- Maximum tire load (→ page 386)
- Load index

Speed rating ⑦:

Specifies the approved maximum speed of the tire.

① An electronic speed limiter prevents your vehicle from exceeding a speed of 130 mph (210 km/h).

Make sure that your tires have the required speed rating. You can obtain information on the required speed rating from an authorized Mercedes-Benz Center.

Summer tires

Index	Speed rating
Q	up to 100 mph (160 km/h)
R	up to 106 mph (170 km/h)
S	up to 112 mph (180 km/h)
T	up to 118 mph (190 km/h)
H	up to 130 mph (210 km/h)
V	up to 149 mph (240 km/h)
W	up to 168 mph (270 km/h)
Y	up to 186 mph (300 km/h)

Index	Speed rating
ZR...Y ¹	up to 186 mph (300 km/h)
ZR...(..Y) ¹	over 186 mph (300 km/h)
ZR ¹	over 149 mph (240 km/h)

- Specifying the speed rating as the "ZR" index in tire code ④ is optional for tires up to 186 mph (300 km/h).
- If your tire code ④ includes "ZR" and there is no speed rating ⑦, find out what the maximum speed is from the tire manufacturer.
- If load-bearing index ⑥ and speed rating ⑦ are in brackets, the maximum speed rating of your tire is above 186 mph (300 km/h). To find out the maximum speed, ask the tire manufacturer.

¹ "ZR" stated in the tire code.

² Or "M+S"  " for winter tires.

All-weather tires and winter tires

Index	Speed rating
Q M+S ²	up to 100 mph (160 km/h)
T M+S ²	up to 118 mph (190 km/h)
H M+S ²	up to 130 mph (210 km/h)
V M+S ²	up to 149 mph (240 km/h)

Winter tires bear the  snowflake symbol and fulfill the requirements of the Rubber Manufacturers Association (RMA) and the Rubber Association of Canada (RAC) regarding the tire traction on snow.

Load index ⑧:

- No specification given: standard load (SL) tire
- "XL" or "Extra Load": extra load tire or reinforced tire
- "Light Load": light load tire

- "C", "D", "E": a load range that depends on the maximum load that the tire can carry at a certain pressure

Definition of terms for tires and loading

Tire structure and characteristics: describes the number of layers or the number of rubber-coated belts in the tire contact surface and the tire wall. These are made of steel, nylon, polyester and other materials.

Bar: metric unit for tire pressure. 14.5038 pounds per square inch (psi) and 100 kilopascal (kPa) is the equivalent of one bar.

DOT (Department of Transportation): DOT-marked tires fulfill the requirements of the US Department of Transportation.

Average weight of the vehicle occupants: the number of vehicle occupants for which the vehicle is designed, multiplied by 150 lb (68 kg).

Uniform Tire Quality Grading Standards: a uniform standard to grade the quality of tires with regard to tread quality, tire traction and temperature characteristics. The quality grading assessment is made by the manufacturer following specifications from the U.S. government. The quality grade of a tire is imprinted on the side wall of the tire.

Recommended tire pressure: the recommended tire pressure is the tire pressure specified for the tires mounted to the vehicle at the factory.

The tire and information table contains the recommended tire pressures for cold tires, the maximum permissible load and the maximum permissible vehicle speed.

The tire pressure table contains the recommended tire pressures for cold tires under various operating conditions, i.e. loading and/or speed of the vehicle.

Increased vehicle weight due to optional equipment: the combined weight of all standard and optional equipment available for the vehicle,

regardless of whether it is actually installed on the vehicle or not.

Rim: the part of the wheel on which the tire is installed.

GAWR (Gross Axle Weight Rating): the GAWR is the maximum permissible axle load. The actual load on an axle must never exceed the gross axle weight rating. The gross axle weight rating can be found on the vehicle identification plate on the B-pillar on the driver's side.

Speed rating: the speed rating is part of the tire identification. It specifies the speed range for which a tire is approved.

GVW (Gross Vehicle Weight): the gross vehicle weight comprises the weight of the vehicle including fuel, tools, the spare wheel, accessories installed, occupants, luggage and the trailer drawbar noseweight, if applicable. The gross vehicle weight must not exceed the gross vehicle weight rating GVWR as specified on the vehicle identification plate on the B-pillar on the driver's side.

GVWR (Gross Vehicle Weight Rating): the GVWR is the maximum permitted gross weight

of the fully laden vehicle (weight of the vehicle including all accessories, occupants, fuel, luggage and the trailer drawbar noseweight if applicable). The gross vehicle weight rating is specified on the vehicle identification plate on the B-pillar on the driver's side.

Maximum weight of the laden vehicle: the maximum weight is the sum of the curb weight of the vehicle, the weight of the accessories, the maximum load and the weight of optional equipment installed at the factory.

Kilopascal (kPa): metric unit for tire pressure. 6.9 kPa corresponds to 1 psi. Another unit for tire pressure is bar. 100 kilopascal (kPa) equals 1 bar.

Load index: in addition to the load-bearing index, the load index may also be imprinted on the side wall of the tire. This specifies the load-bearing capacity of the tire more precisely.

Curb weight: the weight of a vehicle with standard equipment including the maximum capacity of fuel, oil and coolant. It also includes the air conditioning system and optional equipment if

these are installed on the vehicle, but does not include passengers or luggage.

Maximum tire load: the maximum tire load is the maximum permissible weight in kilograms or lbs for which a tire is approved.

Maximum permissible tire pressure: maximum permissible tire pressure for one tire.

Maximum load on one tire: maximum load on one tire. This is calculated by dividing the maximum axle load of one axle by two.

PSI (pounds per square inch): standard unit of measurement for tire pressure.

Aspect ratio: ratio between tire height and tire width in percent.

Tire pressure: pressure inside the tire applying an outward force to every square inch of the tire. The tire pressure is specified in pounds per square inch (psi), in kilopascals (kPa) or in bar. The tire pressure should only be corrected when the tires are cold.

Cold tire pressure: the tires are cold when the vehicle has been parked for at least 3 hours

without direct sunlight on the tires or the vehicle has been driven for less than 1 mile (1.6 km).

Tire contact surface: the part of the tire that comes into contact with the road.

Tire bead: the purpose of the tire bead is to ensure that the tire sits securely on the wheel rim. There are several wire cores in the tire bead to prevent the tire from changing length on the wheel rim.

Side wall: the part of the tire between the tread and the tire bead.

Weight of optional equipment: the combined weight of the optional equipment weighing more than the replaced standard parts and more than 5 lbs (2.3 kg). This optional equipment, such as high-performance brakes, level control system, a roof luggage rack or high-performance batteries, is not included in the curb weight and the weight of the accessories.

TIN (Tire Identification Number): a unique identification number which can be used by a tire manufacturer to identify tires, for example, in a product recall, and thus identify the purchasers. The TIN is made up of the manufactur-

er's identity code, tire size, tire type code and the manufacturing date.

Load-bearing index: the load-bearing index is a code that contains the maximum load-bearing capacity of a tire.

Traction: traction is the grip resulting from friction between the tires and the road surface.

Wear indicator: narrow bars (tread wear bars) that are distributed over the tire contact surface. If the tire tread is level with the bars, the wear limit of 1/16 in (1.6 mm) has been reached.

Distribution of vehicle occupants: distribution of vehicle occupants over designated seat positions in a vehicle.

Maximum permissible payload weight: nominal load and luggage load plus 150 lb (68 kg) multiplied by the number of seats in the vehicle.

Changing a wheel

Notes on selecting, installing and replacing tires

⚠ WARNING Risk of injury through incorrect sizes of wheels and tires

If wheels and tires of the wrong size are installed, the wheel brakes or components in the brake system and in the wheel suspension may be damaged.

- ▶ Always replace wheels and tires with those that fulfill the specifications of the original part.

For wheels, pay attention to the following:

- Designation
- Type

For tires, pay attention to the following:

- Designation
- Manufacturer
- Type

⚠ WARNING Risk of injury through exceeding the specified tire load-bearing capacity or the permissible speed rating

Exceeding the specified tire load rating or the permissible speed rating may lead to tire damage and to the tires bursting.

- ▶ Therefore, only use tire types and sizes approved for your vehicle model.
- ▶ Observe the tire load rating and speed rating required for your vehicle.

! NOTE Vehicle and tire damage through tire types and sizes that have not been approved

For safety reasons, only use tires, wheels and accessories which have been specially approved by Mercedes-Benz for your vehicle.

These tires are specially adapted to the active safety systems, such as ABS, ESP® and 4MATIC, and marked as follows:

- MO = Mercedes-Benz Original

- MOE = Mercedes-Benz Original Extended (run-flat tire only for certain wheels)
- MO1 = Mercedes-Benz Original (only certain AMG tires)

Otherwise, certain properties, such as handling characteristics, vehicle noise emissions, consumption, etc. could be adversely affected. Furthermore, other tire sizes could result in the tires rubbing against the body and axle components when loaded. This could result in damage to the tire or the vehicle.

Only use tires, wheels and accessories that have been checked and recommended by Mercedes-Benz.

! NOTE Risk to driving safety from retreaded tires

Retreaded tires are neither tested nor recommended by Mercedes-Benz, since previous damage cannot always be detected on retreaded tires.

For this reason driving safety cannot be guaranteed.

- ▶ Do not use used tires if you have no information about their previous usage.

! **NOTE** Possible wheel and tire damage when driving over obstacles

Large wheels have a smaller section width. As the section width decreases, the risk of wheels and tires being damaged when driving over obstacles increases.

- ▶ Avoid obstacles or drive especially carefully.
- ▶ Reduce your speed when driving over curbs, speed bumps, manhole covers and potholes.
- ▶ Avoid particularly high curbs.

! **NOTE** Possible wheel and tire damage when parking on curbs or in potholes

Parking on curbs or in potholes may damage the wheels and tires.

- ▶ If possible, park only on flat surfaces.
- ▶ Avoid curbs and potholes when parking.

! **NOTE** Damage to electronic component parts from the use of tire-mounting tools

Vehicles with a tire pressure monitoring system: Electronic component parts are located in the wheel. Tire-mounting tools should not be used in the area of the valve.

This could otherwise damage the electronic component parts.

- ▶ Have the tires changed at a qualified specialist workshop only.

! **NOTE** Damage to summer tires at low ambient temperatures

At low ambient temperatures, tears could form when driving with summer tires, causing permanent damage to the tires.

- ▶ At temperatures below 45 °F (7 °C) use  M+S tires.

Accessory parts which are not approved for your vehicle by Mercedes-Benz, or which are not used correctly, can impair the operating safety.

Before purchasing and using non-approved accessories, visit a qualified specialist workshop and inquire about:

- Suitability
- Legal stipulations
- Factory recommendations

! **WARNING** Risk of accident with high performance tires

The special tire tread in combination with the optimized tire compound means that the risk of skidding and hydroplaning on wet roads is increased.

In addition, the tire grip is greatly reduced at a low outside temperature and tire running temperature.

- ▶ Switch on the ESP® and adapt your driving style accordingly.

- ▶ Use  M+S tires at outside temperatures of less than 50 °F (10 °C).
- ▶ Only use the tires for their intended purpose.

Observe the following when selecting, installing and replacing tires:

- Furthermore, the use of certain tire types in certain regions and areas of operation can be highly beneficial.
- Only use tires and wheels of the same type (summer tires, winter tires, MOExtended tires) and the same make.
- Only install wheels of the same size on one axle (left and right).
It is only permissible to install a different wheel size in the event of a flat tire in order to drive to the specialist workshop.
- **Vehicles with a tire pressure monitoring system:** All installed wheels must be equipped with functioning sensors for the tire pressure monitoring system.

- At temperatures below 45 °F (7 °C) use winter tires or all-season tires marked  M+S for all wheels.

Winter tires provide the best possible grip in wintry road conditions.

- For M+S tires, only use tires with the same tread.
- Observe the maximum permissible speed for the M+S tires installed.
If the tire's maximum speed is below that of the vehicle, this must be indicated by an appropriate label in the driver's field of vision.
- Break in new tires at moderate speeds for the first 60 miles (100 km).
- Replace the tires after six years at the latest, regardless of wear.

- **When replacing with tires that do not feature run-flat characteristics:** vehicles with MOExtended tires are not equipped with a TIREFIT kit at the factory. Equip the vehicle with a TIREFIT kit after replacing with tires

that do not feature run-flat characteristics, e.g. winter tires.

For more information on wheels and tires, contact a qualified specialist workshop.

Be sure to also observe the following further related subjects:

- Notes on tire pressure (→ page 375)
- Tire and Loading Information placard (→ page 380)
- Tire size designation, load-bearing capacity, speed rating and load index (→ page 387)
- Tire pressure table (→ page 376)
- Notes on the emergency spare wheel (→ page 401)

Notes on rotating wheels

 **WARNING** Risk of injury through different wheel sizes

Rotating the front and rear wheels can severely impair the driving characteristics.

The wheel brakes or suspension components may also be damaged.

- ▶ Rotate front and rear wheels only if the wheels and tires are of the same dimensions.

The wear patterns on the front and rear wheels differ:

- Front wheels wear more on the tire shoulder
- Rear wheels wear more in the center of the tire

Do not drive with tires that have too little tread depth. This significantly reduces traction on wet roads (hydroplaning).

On vehicles that have the same size front and rear wheels, rotate the wheels according to the intervals in the tire manufacturer's warranty book in your vehicle documents. If this is not available, rotate the tires every 3000 to 6000 miles (5000 to 10,000 km), depending on the wear. Ensure that the direction of rotation is maintained.

Observe the instructions and safety notes on "Changing a wheel" when doing so (→ page 396).

Notes on storing wheels

When storing wheels, observe the following notes:

- After removing wheels, store them in a cool, dry and preferably dark place.
- Protect the tires from contact with oil, grease or fuel.

Overview of the tire-change tool kit

Apart from some country-specific variants, vehicles are not equipped with a tire-change tool kit. For more information on which tire-changing tools are required and approved for performing a wheel change on your vehicle, consult a qualified specialist workshop.

Required tire-changing tools may include, for example:

- Jack

- Chock
- Lug wrench

The tire-change tool kit is located in tool bag ① on the trunk floor.

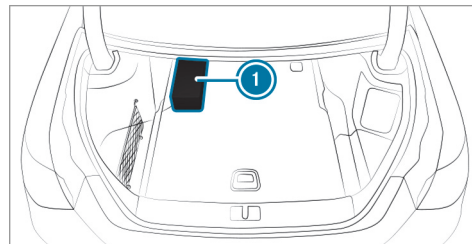

The tool bag contains:

- Jack
- Gloves
- Lug wrench
- Alignment bolt
- Folding chock
- Ratchet for jack

Preparing the vehicle for a wheel change

Requirements:

- The vehicle is not on a slope.
 - The vehicle is on solid, non-slippery and level ground.
 - The required tire-change tool kit is available.
- ❗ If your vehicle is not equipped with the tire-change tool kit, consult a qualified specialist workshop to find out about suitable tools.

- ▶ Apply the electric parking brake manually.
- ▶ Move the front wheels to the straight-ahead position.
- ▶ Shift the transmission to position **P**.
- ▶ **Vehicles with level control system:** Set the normal vehicle level (→ page 257).
- ▶ Switch off the engine.
- ▶ Make sure that the engine cannot be started.
- ▶ Place chocks or other suitable items under the front and rear of the wheel that is diagonally opposite the wheel you wish to change.

- ▶ Remove the hub cap if necessary (→ page 396).
- ▶ Raise the vehicle (→ page 396).

Removing and installing the wheel trim/hub caps

Requirements:

- The vehicle is prepared for a wheel change (→ page 396).

Aluminum hub cap

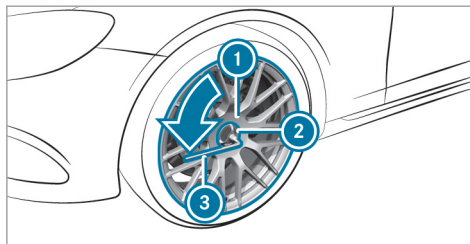

- ▶ **To remove:** position socket ② from the tire-change tool kit on hub cap ①.

- ▶ Position wheel wrench ③ on socket ②.
- ▶ Using wheel wrench ③, turn hub cap ① counter-clockwise and remove it.
- ▶ **To install:** follow the instructions above in reverse order.

❗ **Specified tightening torque:** 18 lb-ft (25 Nm).

Raising the vehicle when changing a wheel

Requirements:

- There are no persons in the vehicle.
- The vehicle has been prepared for a wheel change (→ page 396).
- The hub caps have been removed (→ page 396).

Important notes on using the jack:

- Use only a vehicle-specific jack that has been approved by Mercedes-Benz to raise the vehicle.
- The jack is only designed for raising and holding the vehicle for a short time while a

wheel is being changed and not for maintenance work under the vehicle.

- The jack must be placed on a firm, flat and non-slip surface.
- The foot of the jack must be positioned vertically under the jack support point.

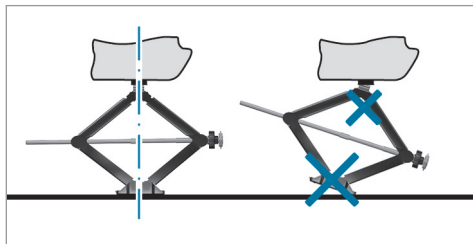

Rules of conduct when the vehicle is raised:

- Never place your hands and/or feet under the vehicle.
- Never lie under the vehicle.
- Do not start the engine and do not release the electric parking brake.

- Do not open or close any doors or the trunk lid.

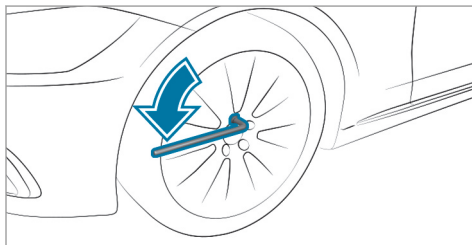

- ▶ Using the lug wrench, loosen the wheel bolts on the wheel you wish to change by about one full turn. Do not unscrew the bolts completely.

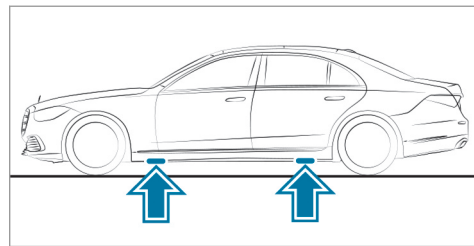

Position of jack support points

⚠ WARNING Risk of injury from incorrect positioning of the jack

If you do not position the jack correctly at the appropriate jacking point of the vehicle, the jack could tip with the vehicle raised.

- ▶ Only position the jack at the appropriate jacking point of the vehicle. The base of the jack must be positioned vertically under the jacking point of the vehicle.

! NOTE Vehicle damage from the jack

If you do not position the jack correctly at the appropriate jack support point of the vehicle, the jack could tip over with the vehicle raised.

▶ The jack is designed exclusively for jacking up the vehicle at the jack support points.

▶ Take the ratchet wrench out of the tire-change tool kit and place it on the hexagon nut of the jack so that the letters "AUF" are visible.

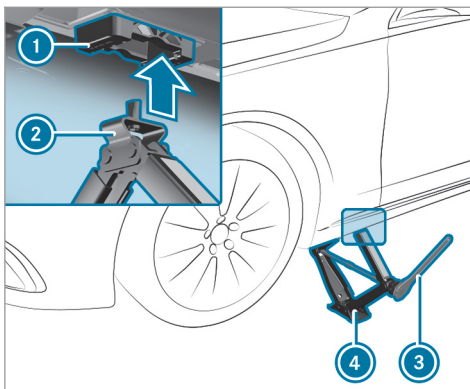

- ▶ Position support ② of jack ④ on jack support point ①.
- ▶ Turn ratchet wrench ③ clockwise until jack support ② sits completely on jack support point ① and the base of the jack lies evenly on the ground.
- ▶ Continue to turn ratchet wrench ③ until the tire is raised a maximum of 1.2 in (3 cm) off the ground.

▶ Loosen and remove the wheel (→ page 398).

Removing a wheel**Requirements:**

- The vehicle is raised.

When changing a wheel, avoid applying any force to the brake discs, as this could impair the level of comfort when braking.

! NOTE Damage to threading from dirt on wheel bolts

▶ Do not place wheel bolts in sand or on a dirty surface.

▶ Unscrew the uppermost wheel bolt completely.

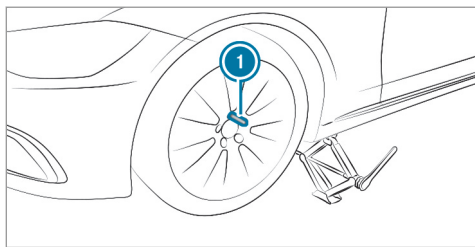

- ▶ Screw alignment bolt ① into the thread instead of the wheel bolt.
- ▶ Unscrew the remaining wheel bolts completely.
- ▶ Remove the wheel.

Installing a new wheel

⚠ WARNING Risk of accident from losing a wheel

Oiled, greased or damaged wheel bolt/wheel nut threads or wheel hub/wheel mounting

bolt threads can cause the wheel bolts/wheel nuts to come loose.

- ▶ Never oil or grease the threads.
- ▶ In the event of damage to the threads, contact a qualified specialist workshop immediately.
- ▶ Have the damaged wheel bolts or damaged hub threads replaced.
- ▶ Do not continue driving.

- ▶ Observe the information on the choice of tires (→ page 392).

For tires with a specified direction of rotation, an arrow on the side wall of the tire indicates the correct direction of rotation. Observe the direction of rotation when installing.

- ▶ Slide the wheel to be mounted onto the alignment bolt and push it on.

⚠ WARNING Risk of injury from tightening wheel bolts and nuts

If you tighten the wheel bolts or wheel nuts when the vehicle is raised, the jack could tip.

- ▶ Only tighten wheel bolts or wheel nuts when the vehicle is on the ground.

- ▶ Be sure to observe the instructions and safety notes on "Changing a wheel" (→ page 392).
- ▶ For safety reasons, only use wheel bolts which have been approved by Mercedes-Benz and for the wheel in question.

! NOTE Damage to paintwork of the wheel rim when screwing in the first wheel bolt

If the wheel has too much play when screwing in the first wheel bolt, the wheel rim paint can be damaged.

- ▶ Press the wheel firmly against the wheel hub when screwing in the first wheel bolt.

400 Wheels and tires

- ▶ Tighten the wheel bolts evenly in a diagonal pattern in the order indicated until they are finger-tight.
- ▶ Unscrew and remove the alignment bolt.
- ▶ Tighten the last wheel bolt until it is finger-tight.
- ▶ Lower the vehicle (→ page 400).

Lowering the vehicle after a wheel change

Requirements:

- The new wheel has been installed (→ page 399).

! NOTE Risk of trapping the jack

If the AIRMATIC system has released air when raising the vehicle, the jack can become trapped when the vehicle is lowered.

- ▶ Start the engine. This adapts the vehicle level.
- ▶ Remove the jack from under the vehicle.

- ▶ **To lower the vehicle:** place the ratchet onto the hexagon nut of the jack so that the letters "AB" are visible and turn counter-clockwise.

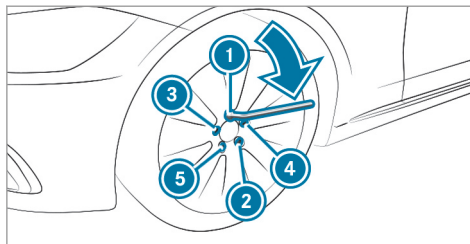

- ▶ Tighten the wheel bolts evenly in a diagonal pattern in the order indicated ① to ⑤ with an initial maximum force of 59 lb-ft (80 Nm).
- ▶ Tighten the wheel bolts evenly in a diagonal pattern in the order indicated ① to ⑤ with the specified tightening torque of 111 lb-ft (150 Nm).

! WARNING Risk of accident due to incorrect tightening torque

The wheels could come loose if the wheel bolts or wheel nuts are not tightened to the prescribed torque.

- ▶ Ensure that the wheel bolts or wheel nuts are tightened to the prescribed tightening torque.
- ▶ If you are not sure, do not move the vehicle. Contact a qualified specialist workshop and have the tightening torque checked immediately.

- ▶ Check the tire pressure of the newly installed wheel and adjust it if necessary.

i The following does not apply if the new wheel is an emergency spare wheel.

- ▶ **Vehicles with a tire pressure monitoring system:** Restart the tire pressure monitoring system (→ page 379).

Emergency spare wheel

Notes on the emergency spare wheel

⚠ WARNING Risk of accident caused by incorrect wheel and tire dimensions

The wheel or tire size and the tire type of the emergency spare wheel or spare wheel and the wheel to be replaced may differ. The emergency spare wheel or spare wheel can significantly impair driving characteristics of the vehicle.

To prevent hazardous situations:

- ▶ Adapt your driving style accordingly and drive carefully.
- ▶ Never install more than one emergency spare wheel or spare wheel that differs in size.
- ▶ Only use an emergency spare wheel or spare wheel of a different size briefly.
- ▶ Do not switch off ESP®.
- ▶ Have the emergency spare wheel or spare wheel of a different size replaced at the nearest qualified specialist work-

shop. The new wheel must have the correct dimensions.

i The emergency spare wheel is secured in the emergency spare wheel bag in the trunk.

Observe the following notes on installing an emergency spare wheel:

- Check the tire pressure of the emergency spare wheel installed. Correct the pressure as necessary.
- The maximum permissible speed with an emergency spare wheel installed is 50 mph (80 km/h).
- Do not install the emergency spare wheel with snow chains.
- Replace the emergency spare wheel after six years at the latest, regardless of wear.
- Use the wheel bolts that are included with the emergency spare wheel.

Specified tightening torque: 96 lb-ft (130 Nm)

i Vehicles with a tire pressure monitoring system: If an emergency spare wheel is

installed, the tire pressure monitoring system cannot function reliably. For a few minutes after an emergency spare wheel is installed, the system may still display the tire pressure of the removed wheel. Only restart the system again when the emergency spare wheel has been replaced with a new wheel.

Be sure to also observe the following further related subjects:

- Notes on tire pressure (→ page 375)
- Tire and Loading Information placard (→ page 380)
- Tire pressure table (→ page 376)
- Notes on installing tires (→ page 392)

Notes on technical data

The data stated only applies to vehicles with standard equipment. You can obtain further information from an authorized Mercedes-Benz Center.

Vehicle electronics

Two-way radios

Notes on installing two-way radios

⚠ WARNING Risk of accident due to improper work on two-way radios

If two-way radios are manipulated or retrofitted incorrectly, the electromagnetic radiation from the two-way radios can interfere with the vehicle electronics and jeopardize the operating safety of the vehicle.

- ▶ You should have all work on electrical and electronic components carried out at a qualified specialist workshop.

⚠ WARNING Risk of accident due to improper operation of two-way radios

If you use two-way radios in the vehicle improperly, their electromagnetic radiation can disrupt the vehicle's electronics. This is the case in the following situations, in particular:

- The two-way radio is not connected to an exterior antenna.
- The exterior antenna is installed incorrectly or is not a low-reflection antenna.

This could jeopardize the operating safety of the vehicle.

- ▶ Have the low-reflection exterior antenna installed at a qualified specialist workshop.
- ▶ When operating two-way radios in the vehicle, always connect them to the low-reflection exterior antenna.

! NOTE Invalidation of the operating permit due to failure to comply with the instructions for installation and use

The operating permit may be invalidated if the instructions for installation and use of two-way radios are not observed.

- ▶ Only use approved frequency bands.
- ▶ Observe the maximum permissible output power in these frequency bands.
- ▶ Only use approved antenna positions.

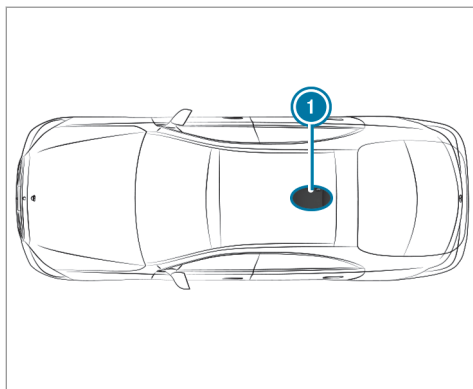

Vehicles without panoramic sliding sunroof

① Rear roof area

On vehicles with a panoramic sliding sunroof, installing an antenna is not permitted.

Use Technical Specification ISO/TS 21609 (Road Vehicles - "EMCs for installation of aftermarket radio frequency transmitting equipment") when

retrofitting two-way radios. Comply with the legal requirements for detachable parts.

If your vehicle has installations for two-way radio equipment, use the power supply and antenna connectors provided in the pre-installation. Observe the manufacturer's supplements when installing.

Two-way radio transmission output

The maximum transmission output (PEAK) at the base of the antenna must not exceed the values in the following table:

Frequency band and maximum transmission output

Frequency band	Maximum transmission output
2 m frequency band 144 - 174 MHz	50 W
Terrestrial Trunked Radio (TETRA) 380 - 460 MHz	10 W

Frequency band	Maximum transmission output
70 cm frequency band 430 - 470 MHz	35 W
Two-way radio 2G	2 W
Two-way radio 3G/4G/5G	0.5 W

The following devices can be used in the vehicle without restrictions:

- Two-way radios with a maximum transmission output of up to 100 mW
- Two-way radios with transmitter frequencies in the 380 - 420 MHz frequency band and a maximum transmission output of up to 2 W (TETRA)
- Mobile phones (2G/3G/4G/5G)

404 Technical data

There are no restrictions when positioning the antenna on the outside of the vehicle for the following frequency bands:

- TETRA
- 2G/3G/4G/5G

Regulatory radio identification of small components

Not all regulatory radio identification can be applied to small components due to their geometric dimensions. Therefore, the following tables list the manufacturers of these components and the countries/regions with the identification required by radio regulations.

Overview of manufacturers

Manufacturer's abbreviated designation	Manufacturer information
ADC	ADC Automotive Distance Control Systems GmbH, Peter-Dornier-Straße 10, 88131 Lindau, Germany
Bosch	Robert Bosch GmbH, Daimlerstraße 6, 71229 Leonberg, Germany
Continental Antenna	Continental Advanced Antenna GmbH, Römerring 1, 31137 Hil-desheim, Germany
Continental Automotive	Continental Automotive GmbH, Siemensstraße 12, 93055 Regensburg, Germany
Gentex	Gentex Corporation, 600 North Centennial Street, Zeeland MI 49464, USA

Manufacturer's abbreviated designation	Manufacturer information
HELLA	HELLA KGaA Hueck & Co., Rix-becker Straße 75, 59552 Lippstadt, Germany
Hirschmann	Hirschmann Car Communication GmbH, Stuttgarter Straße 45-51, 72654 Neckartenzlingen, Germany
Huf Bao-long	Huf Baolong Electronics Bretten GmbH, Gewerbestraße 40, 75015 Bretten, Germany
HUF	HUF Hülsbeck & Fürst GmbH & Co. KG, Steeger Straße 17, 42551 Velbert, Germany
KATHREIN	KATHREIN Automotive GmbH & Co. KG, Römerring 1, 31137 Hil-desheim, Germany

Manufacturer's abbreviated designation	Manufacturer information
LEOPOLD KOSTAL	LEOPOLD KOSTAL GmbH & Co. KG, Hauert 11, 44227 Dortmund, Germany
MARQUARDT	MARQUARDT GmbH, Schloßstraße 16, 78604 Rietheim-Weilheim, Germany
Meta System	Meta System S.P.A., Via T. Galimbreti 5, 42124 Reggio Emilia, Italy
Panasonic	Panasonic Automotive Systems Europe GmbH, Robert-Bosch-Straße 27, 63225 Langen, Germany
Schrader	Schrader Electronics Ltd., 11 Technology Park, Belfast Road, Antrim BT41 1QS, Northern Ireland, United Kingdom

Manufacturer's abbreviated designation	Manufacturer information
Veoneer	Veoneer Sweden AB, Wallentinsvägen 22, 44737 Vårgårda, Sweden
WITTE-Velbert	WITTE-Velbert GmbH & Co. KG, Hoefestr. 3-15, 42551 Velbert, Germany

Argentina

Manufacturer	Model designation	Radio equipment approval number (if available)
ADC	ARS4-A (radar sensor)	C-18005
ADC	ARS4-B (radar sensor)	C-17908
ADC	ARS4-C (radar sensor)	C-23776
Bosch	MRR1Rear (radar sensor)	C-21798
Bosch	MRRre14FCR (radar sensor)	C-20030



Manufacturer	Model designation	Radio equipment approval number (if available)
Bosch	FR5CPCCF (radar sensor)	H-23855
Continental Antenna	RKE213E1 (antenna amplifier)	H-15475
Continental Antenna	RKE223E1 (antenna amplifier)	H-24637
Continental Automotive	CMKG1 (locking system)	H-24376
Continental Automotive	MARS Keyless (locking system)	H-17929



Manufacturer	Model designation	Radio equipment approval number (if available)
Continental Automotive	D-WMI2020A (control unit)	H-23974 DI-2019-9 794-APN- DNAYRT# ENACOM
HELLA	DM4 (locking system)	H-17845
Hirschmann	920287A (locking system)	H-15694
Hirschmann	920287B (locking system)	H-15695



Manufacturer	Model designation	Radio equipment approval number (if available)
Huf Baolong	TSSRE4A (tire pressure monitor sensor)	H-20027
HUF	HUF14632 (locking system)	H-15541
HUF	HUF4761 (locking system)	H-11545
LEOPOLD KOSTAL	KK1 (locking system)	H-16874
MAR-QUARDT	DC12A (locking system)	H-17689



Manufacturer	Model designation	Radio equipment approval number (if available)
MAR-QUARDT	DC 12B (locking system)	H-21034
MAR-QUARDT	DC 12K (locking system)	H-21035
MAR-QUARDT	MS2 (locking system)	H-17598
MAR-QUARDT	MS4 (locking system)	H-23101
MAR-QUARDT	MS5 (locking system)	H-24933



Manufacturer	Model designation	Radio equipment approval number (if available)
MAR-QUARDT	MK 1 (locking system)	H-17213
MAR-QUARDT	MK2 (locking system)	H-17212
MAR-QUARDT	3350.38 (locking system)	H-23166
MAR-QUARDT	MU 1 (locking system)	H-23102
MAR-QUARDT	MU2 (locking system)	H-24936



Manufacturer	Model designation	Radio equipment approval number (if available)
Schrader	AG5SP4 (tire pressure monitor sensor)	H-4788
Schrader	GG4T (tire pressure monitor sensor)	H-20495
Schrader	DG6W2D4 (tire pressure monitor sensor)	H-20959
Veoneer	77V12BSM (radar sensor)	C-23670



Manufacturer	Model designation	Radio equipment approval number (if available)
Veoneer	77V12CRN (radar sensor)	C-23672
Veoneer	77GHz MMRV1 (radar sensor)	EXPENACOM 9967/2017
WITTE-Velbert	SDHTAG3NFC (locking system)	H-24664

Australia



Manufacturer	Model designation	Radio equipment approval number (if available)
Huf Baolong	TSSRE4A (tire pressure monitor sensor)	—
Huf Baolong	TSSSG4G6 (tire pressure monitor sensor)	—
Huf Baolong	TSSSG4G6b (tire pressure monitor sensor)	—
Schrader	AG5SP4 (tire pressure monitor sensor)	—





Manufacturer	Model designation	Radio equipment approval number (if available)
Schrader	GG4T (tire pressure monitor sensor)	—
Schrader	DG6W2D4 (tire pressure monitor sensor)	—

Bahamas

Manufacturer	Model designation	Radio equipment approval number (if available)
Veoneer	77V12BSM (radar sensor)	FCC ID: WU877V12BSM
Veoneer	77V12CRN (radar sensor)	FCC ID: WU877V12CRN

Belarus

		
Manufacturer	Model designation	Radio equipment approval number (if available)
Continental Antenna	RKE223E1 (antenna amplifier)	—
Continental Automotive	CMKG1 (locking system)	—
Continental Automotive	MARS Keyless (locking system)	—
HELLA	DM4 (locking system)	—

		
Manufacturer	Model designation	Radio equipment approval number (if available)
MAR-QUARDT	DC12A (locking system)	—
MAR-QUARDT	DC12B (locking system)	—
MAR-QUARDT	DC12K (locking system)	—
MAR-QUARDT	MS2 (locking system)	—
MAR-QUARDT	MS4 (locking system)	—



Manufacturer	Model designation	Radio equipment approval number (if available)
MAR-QUARDT	MS5 (locking system)	—
MAR-QUARDT	MK1 (locking system)	—
MAR-QUARDT	MK2 (locking system)	—
MAR-QUARDT	MU1 (locking system)	—



Manufacturer	Model designation	Radio equipment approval number (if available)
MAR-QUARDT	MU2 (locking system)	—
WITTE-Velbert	SDHTAG3NFC (locking system)	—

Botswana

Manufacturer	Model designation	Radio equipment approval number (if available)
ADC	ARS4-A (radar sensor)	BOCRA/TA/2018/2026
ADC	ARS4-B (radar sensor)	BOCRA/TA/2019/4582
Bosch	FR5CPCCF (radar sensor)	BOCRA/TA/2019/4975
Bosch	MRR1Rear (radar sensor)	BOCRA/TA/2017/3788
Continental Antenna	RKE213E1 (antenna amplifier)	BOCRA/TA/2017/4387
Continental Antenna	RKE223E1GN S (antenna amplifier)	BOCRA/TA/2017/5050

Manufacturer	Model designation	Radio equipment approval number (if available)	Manufacturer	Model designation	Radio equipment approval number (if available)	Manufacturer	Model designation	Radio equipment approval number (if available)
Continental Automotive	CMKG1 (locking system)	BOCRA/TA/2019/5075	HUF	HUF4761 (locking system)	BOCRA/TA/2019/4664	MAR-QUARDT	MS5 (locking system)	BOCRA/TA/2020/5473
Continental Automotive	MARS Keyless (locking system)	BOCRA/TA/2019/4661	LEOPOLD KOSTAL	KK1 (locking system)	BOCRA/TA/2019/4593	MAR-QUARDT	MK1 (locking system)	BOCRA/TA/2019/4359
HELLA	DM4 (locking system)	BOCRA/TA/2019/4662	MAR-QUARDT	DC12A (locking system)	BOCRA/TA/2019/4389	MAR-QUARDT	MK2 (locking system)	BOCRA/TA/2019/4360
Hirschmann	920287A (locking system)	BOCRA/TA/2019/4724	MAR-QUARDT	DC12B (locking system)	BOCRA/TA/2019/4388	MAR-QUARDT	3350.38 (locking system)	BOCRA/TA/2019/4687
Hirschmann	920287B (locking system)	BOCRA/TA/2019/4723	MAR-QUARDT	DC12K (locking system)	BOCRA/TA/2019/4390	MAR-QUARDT	MU1 (locking system)	BOCRA/TA/2019/4759
Huf Baolong	TSSRE4A (tire pressure monitor sensor)	No. 20233	MAR-QUARDT	MS2 (locking system)	BOCRA/TA/2019/5135	Schrader	AG5SP4 (tire pressure monitor sensor)	No. 1967
			MAR-QUARDT	MS4 (locking system)	BOCRA/TA/2019/4758	Veoneer	77V12BSM (radar sensor)	BOCRA/TA/2019/4975

412 Technical data

Manufacturer	Model designation	Radio equipment approval number (if available)
Veoneer	77V12CRN (radar sensor)	BOCRA/TA/2019/4980
WITTE-Velbert	SDHTAG3NFC (locking system)	BOCRA/TA/20205342

Brazil

		
Manufacturer	Model designation	Radio equipment approval number (if available)
ADC	ARS4-C (radar sensor)	06783-19-02496
Bosch	FR5CPCCF (radar sensor)	06351-19-03745
Continental Antenna	RKE213E1 (antenna amplifier)	3691-15-5298
Continental Automotive	CMKG1 (locking system)	00325-20-02149

		
Manufacturer	Model designation	Radio equipment approval number (if available)
Continental Automotive	MARS Keyless (locking system)	03189-17-02856
HELLA	DM4 (locking system)	04689-17-05364
Hirschmann	920287A (locking system)	1855-12-5762
Hirschmann	920287B (locking system)	1787-12-8058

		
Manufacturer	Model designation	Radio equipment approval number (if available)
HUF	HUF14632 (locking system)	03627-15-06643
HUF	HUF4761 (locking system)	00053-13-06643
MAR-QUARDT	DC12A (locking system)	01333-17-02930
MAR-QUARDT	DC12B (locking system)	01395-11-02930
MAR-QUARDT	DC12K (locking system)	01392-11-02930

		
Manufacturer	Model designation	Radio equipment approval number (if available)
MAR-QUARDT	MS2 (locking system)	00616-17-02930
MAR-QUARDT	MS4 (locking system)	06218-19-02930
MAR-QUARDT	MS5 (locking system)	11149-20-02930
MAR-QUARDT	3350.38 (locking system)	03149-19-02930
MAR-QUARDT	MK1 (locking system)	03756-15-02930

		
Manufacturer	Model designation	Radio equipment approval number (if available)
MAR-QUARDT	MK2 (locking system)	03757-15-02930
Veoneer	77V12BSM (radar sensor)	06468-19-12386
Veoneer	77V12CRN (radar sensor)	06352-19-12386
WITTE-Velbert	SDHTAG3NFC (locking system)	03034-20-07018

Brunei Darussalam

		
Manufacturer	Model designation	Radio equipment approval number (if available)
ADC	ARS4-C (radar sensor)	DRQ-D-JATI-07-2000-109000 DTA-004005
Bosch	FR5CPCCF (radar sensor)	DRQ-D-JATI-07-2000-109000 DTA-004222
Bosch	LRR3 (radar sensor)	DRQ-D-MAJU-02-2011-111083-LPD-31820

		
Manufacturer	Model designation	Radio equipment approval number (if available)
Bosch	MRR1Rear (radar sensor)	DRQ-DMAJU-02-2011-111083-LPD-31504
Bosch	MRRre14FCR (radar sensor)	DTA-000793
Continental Antenna	RKE213E1 (antenna amplifier)	DRQ-D-JATI-07-2000-109000 DTA-006665

		
Manufacturer	Model designation	Radio equipment approval number (if available)
Continental Antenna	RKE223E1GNS (antenna amplifier)	DRQ-D-JATI-07-2000-109000 DTA-004998
Continental Automotive	CMKG1 (locking system)	DRQ-D-JATI-07-2000-109000 DTA-005043
Continental Automotive	MARS Keyless (locking system)	DRQ-D-MAJU-02-2011-111083-LPD-39004

		
Manufacturer	Model designation	Radio equipment approval number (if available)
HELLA	DM4 (locking system)	DRQ-DJATI-07-2000-109000 DTA-000351
Hirschmann	920287A (locking system)	DRQ-DJATI-07-2000-109000 DTA-001661
Hirschmann	920287B (locking system)	DRQ-DMAJU-02-2011-111083 DTA-000794

		
Manufacturer	Model designation	Radio equipment approval number (if available)
Huf Baolong	TSSRE4A (tire pressure monitor sensor)	DTA No. 000310
Huf Baolong	TSSSG4G6 (control unit) (tire pressure monitor sensor)	DTA No. 000311

		
Manufacturer	Model designation	Radio equipment approval number (if available)
Huf Baolong	TSSSG4G6b (control unit) (tire pressure monitor sensor)	DTA No. 003757
HUF	HUF14632 (locking system)	DRQ-DJATI-07-2000-109000 DTA-006138
HUF	HUF4761 (locking system)	DRQ-DJATI-07-2000-109000 DTA-000615

		
Manufacturer	Model designation	Radio equipment approval number (if available)
LEOPOLD KOSTAL	KK1 (locking system)	DTL-D-MAJU-02-2011-11083 DTA-007245
MAR-QUARDT	DC12A (locking system)	DRQ-DJATI-07-2000-8916-LPD-38937
MAR-QUARDT	DC12B (locking system)	DRQ-DJATI-07-2000-109000 DTA-000068

		
Manufacturer	Model designation	Radio equipment approval number (if available)
MAR-QUARDT	DC12K (locking system)	DRQ-DJATI-07-2000-109000 DTA-000066
MAR-QUARDT	MS2 (locking system)	DRQ-DJATI-07-2000-8916-LPD-38890
MAR-QUARDT	MS4 (locking system)	DRQ-DJATI-07-2000-109000 DTA-003525

		
Manufacturer	Model designation	Radio equipment approval number (if available)
MAR-QUARDT	MS5 (locking system)	DRQ-DJATI-07-2000-109000 DTA-005850
MAR-QUARDT	MK1 (locking system)	DRQ-DJATI-07-2000-8916-LPD-33567
MAR-QUARDT	MK2 (locking system)	DRQ-DJATI-07-2000-8916-LPD-33568
MAR-QUARDT	3350.38 (locking system)	DRQ-DJATI-07-2000-109000 DTA-003662

		
Manufacturer	Model designation	Radio equipment approval number (if available)
MAR-QUARDT	MU1 (locking system)	DRQ-DJATI-07-2000-109000 DTA-003524
MAR-QUARDT	MU2 (locking system)	DRQ-DJATI-07-2000-109000 DTA-005843

		
Manufacturer	Model designation	Radio equipment approval number (if available)
Schrader	AG5SP4 (tire pressure monitor sensor)	DRQ-D-QAF AUTO-05-2003-1089 4-LPD-29559 DRQ-D-JATI-07-2000-8916LPD-29665
Schrader	DG6W2D4 (tire pressure monitor sensor)	DTA-001514

		
Manufacturer	Model designation	Radio equipment approval number (if available)
Schrader	MFR (control unit) (tire pressure monitor sensor)	DTA No. 003893
Veoneer	77V12BSM (radar sensor)	DRQ-D-JATI-07-2000-109000 DTA-004000
Veoneer	77V12CRN (radar sensor)	DRQ-D-JATI-07-2000-109000 DTA-003999

		
Manufacturer	Model designation	Radio equipment approval number (if available)
Veoneer	77GHz MMRV1 (radar sensor)	DRQ-D-JATI-07-2000-8916-LPD-30870
WITTE-Velbert	SDHTAG3NFC (locking system)	DRQ-D-JATI-07-2000-109000DTA-005628

Ghana

Manufacturer	Model designation	Radio equipment approval number (if available)
		NCA APPROVED
ADC	ARS4-B (radar sensor)	1R3-1M-7E1-160
ADC	ARS4-C (radar sensor)	ZRO-1H-7E3-152
Bosch	FR5CPCCF (radar sensor)	ZRO-M8-7E3-230
Continental Antenna	RKE213E1 (antenna amplifier)	ZRO-M8-7E3-X53
Continental Antenna	RKE223E1GNS (antenna amplifier)	ZRO-M8-7E3-225

Manufacturer	Model designation	Radio equipment approval number (if available)
Continental Automotive	CMKG1 (locking system)	ZRO-M8-7E3-277
Continental Automotive	MARS Keyless (locking system)	BR3-1M-GE2-16A
HELLA	DM4 (locking system)	BR3-1M-GE2-157
Hirschmann	920287A (locking system)	ZRO-M8-7E3-X45
Hirschmann	920287B (locking system)	ZRO-M8-7E3-X47
HUF	HUF4761 (locking system)	EX6-6M-GE2-16C

Manufacturer	Model designation	Radio equipment approval number (if available)
LEOPOLD KOSTAL	KK1 (locking system)	ZRO-M8-7E3-X49
MAR-QUARDT	DC12A (locking system)	ZRO-M8-7E3-X50
MAR-QUARDT	DC12B (locking system)	ZRO-M8-7E3-X51
MAR-QUARDT	DC12K (locking system)	ZRO-M8-7E3-X52
MAR-QUARDT	MS2 (locking system)	BR3-1M-GE-129
MAR-QUARDT	MS4 (locking system)	ZRO-1H-7E3-26 E
MAR-QUARDT	MS5 (locking system)	SRO-1M-7E4-11 B

Manufacturer	Model designation	Radio equipment approval number (if available)
MAR-QUARDT	MK1 (locking system)	ZRO-M8-7E3-X4A
MAR-QUARDT	MK2 (locking system)	ZRO-M8-7E3-X4C
MAR-QUARDT	3350.38 (locking system)	ZRO-M8-7E3-X3C
MAR-QUARDT	MU1 (locking system)	ZRO-M8-7E3-272
Veoneer	77V12BSM (radar sensor)	ZRO-1H-7E3-14 2

Manufacturer	Model designation	Radio equipment approval number (if available)
Veoneer	77V12CRN (radar sensor)	ZRO-M8-7E3-230
WITTE-Velbert	SDHTAG3NFC (locking system)	SRO-1M-7E4-X59





Indonesia







Manufacturer	Model designation	Radio equipment approval number (if available)
ADC	ARS4-A (radar sensor)	36010/SDPPI/2017 2130
ADC	ARS4-B (radar sensor)	38132/SDPPI/2017 2130

Manufacturer	Model designation	Radio equipment approval number (if available)
ADC	ARS4-C (radar sensor)	68676/SDPPI/ 2020  Dilarang melakukan perubahan spesifikasi yang dapat menimbulkan gangguan fisik dan/atau elektromagnetik terhadap lingkungan sekitarnya 

Manufacturer	Model designation	Radio equipment approval number (if available)
ADC	ARS4-A (radar sensor)	70266/SDPPI/ 2020 7163 
Bosch	LRR3 (radar sensor)	40556/SDPPI/ 2018
Bosch	MRR1Rear (radar sensor)	34538/SDPPI/ 2017
Bosch	MRRe14FCR (radar sensor)	53078/SDPPI/ 2017 PLG3612

Manufacturer	Model designation	Radio equipment approval number (if available)
Bosch	FR5CPCCF (radar sensor)	67882/SDPPI/ 2020  Dilarang melakukan perubahan spesifikasi yang dapat menimbulkan gangguan fisik dan/atau elektromagnetik terhadap lingkungan sekitarnya 

Manufacturer	Model designation	Radio equipment approval number (if available)	Manufacturer	Model designation	Radio equipment approval number (if available)	Manufacturer	Model designation	Radio equipment approval number (if available)
Continental Antenna	RKE213E1 (antenna amplifier)	41771/SDPPI/2018 5205	Continental Antenna	RKE223E1G NS (antenna amplifier)	66185/SDPPI/2020 10325  Dilarang melakukan perubahan spesifikasi yang dapat menimbulkan gangguan fisik dan/atau elektromagnetik terhadap lingkungan sekitarnya 	Continental Automotive	D-WMI2020A (control unit)	66678/SDPPI/2020 7163  Dilarang melakukan perubahan spesifikasi yang dapat menimbulkan gangguan fisik dan/atau elektromagnetik terhadap lingkungan sekitarnya 

Manufacturer	Model designation	Radio equipment approval number (if available)	Manufacturer	Model designation	Radio equipment approval number (if available)	Manufacturer	Model designation	Radio equipment approval number (if available)
Continental Automotive	CMKG1 (locking system)	66911/ SDPPI/ 2020 7163  Dilarang melakukan perubahan spesifikasi yang dapat menimbulkan gangguan fisik dan/atau elektromagnetik terhadap lingkungan sekitarnya 	Continental Automotive	MARS Keyless (locking system)	69379/SDPPI/ 2020 7163  Dilarang melakukan perubahan spesifikasi yang dapat menimbulkan gangguan fisik dan/atau elektromagnetik terhadap lingkungan sekitarnya 	HELLA	DM4 (locking system)	69378/SDPPI/ 2020 7163  Dilarang melakukan perubahan spesifikasi yang dapat menimbulkan gangguan fisik dan/atau elektromagnetik terhadap lingkungan sekitarnya 

Manufacturer	Model designation	Radio equipment approval number (if available)
Hirschmann	920287A (locking system)	29510/SDPPI/2016 3159
Hirschmann	920287B (locking system)	28238/SDPPI/2016 3159
Huf Bao-long	TSSRE4A (tire pressure monitor sensor)	52166/SDPPI/2017 3533
HUF	HUF14632 (locking system)	41618/SDPPI/2018 3533
HUF	HUF4761 (locking system)	26742/SDPPI/2015 3533







Manufacturer	Model designation	Radio equipment approval number (if available)
KATHREIN	RKE213E1 (locking system)	41771/SDPPI/2018 5205
LEOPOLD KOSTAL	KK1 (locking system)	41121/SDPPI/2018 5125







Manufacturer	Model designation	Radio equipment approval number (if available)
MAR-QUARDT	DC12A (locking system)	67373/SDPPI/2020 7163









Dilarang melakukan perubahan spesifikasi yang dapat menimbulkan gangguan fisik dan/atau elektromagnetik terhadap lingkungan sekitarnya



Manufacturer	Model designation	Radio equipment approval number (if available)	Manufacturer	Model designation	Radio equipment approval number (if available)	Manufacturer	Model designation	Radio equipment approval number (if available)
MAR-QUARDT	DC12B (locking system)	59840/SDPPI/2019 7163  Dilarang melakukan perubahan spesifikasi yang dapat menimbulkan gangguan fisik dan/atau elektromagnetik terhadap lingkungan sekitarnya 	MAR-QUARDT	DC12K (locking system)	59838/SDPPI/2019 7163  Dilarang melakukan perubahan spesifikasi yang dapat menimbulkan gangguan fisik dan/atau elektromagnetik terhadap lingkungan sekitarnya 	MAR-QUARDT	MS2 (locking system)	67372/SDPPI/2020 7163  Dilarang melakukan perubahan spesifikasi yang dapat menimbulkan gangguan fisik dan/atau elektromagnetik terhadap lingkungan sekitarnya 

Manufacturer	Model designation	Radio equipment approval number (if available)	Manufacturer	Model designation	Radio equipment approval number (if available)	Manufacturer	Model designation	Radio equipment approval number (if available)
MAR-QUARDT	MS4 (locking system)	64126/SDPPI/2019 7163  Dilarang melakukan perubahan spesifikasi yang dapat menimbulkan gangguan fisik dan/atau elektromagnetik terhadap lingkungan sekitarnya 	MAR-QUARDT	MS5 (locking system)	69077/SDPPI/2020 7163  Dilarang melakukan perubahan spesifikasi yang dapat menimbulkan gangguan fisik dan/atau elektromagnetik terhadap lingkungan sekitarnya 	MAR-QUARDT	MK1 (locking system)	40283/SDPPI/2018 2208  Dilarang melakukan perubahan spesifikasi yang dapat menimbulkan gangguan fisik dan/atau elektromagnetik terhadap lingkungan sekitarnya 

Manufacturer	Model designation	Radio equipment approval number (if available)	Manufacturer	Model designation	Radio equipment approval number (if available)	Manufacturer	Model designation	Radio equipment approval number (if available)
MAR-QUARDT	MK2 (locking system)	40282/SDPPI/2018 2208  Dilarang melakukan perubahan spesifikasi yang dapat menimbulkan gangguan fisik dan/atau elektromagnetik terhadap lingkungan sekitarnya 	MAR-QUARDT	3350.38 (locking system)	62233/SDPPI/2019 7163  Dilarang melakukan perubahan spesifikasi yang dapat menimbulkan gangguan fisik dan/atau elektromagnetik terhadap lingkungan sekitarnya 	Panasonic	DAIRSE	63550/SDPPI/2019  Dilarang melakukan perubahan spesifikasi yang dapat menimbulkan gangguan fisik dan/atau elektromagnetik terhadap lingkungan sekitarnya  nya

Manufacturer	Model designation	Radio equipment approval number (if available)
Schrader	GG4T (tire pressure monitor sensor)	54083/SDPPI/2017 PLG3612
Schrader	AG5SP4-D (tire pressure monitor sensor)	38892/SDPPI/2018 3612
Schrader	DG6W2D4 (tire pressure monitor sensor)	57058/SDPPI/2018 PLG3612
Schrader	MC34MA4 (tire pressure monitor sensor)	25626/SDPPI/2015 PLG3612

Manufacturer	Model designation	Radio equipment approval number (if available)
Veoneer	77GHz MMRV1 (radar sensor)	40524/R/I/SDPPI/2018

Manufacturer	Model designation	Radio equipment approval number (if available)
Veoneer	77V12CRN (radar sensor)	66830/SDPPI/2020 7163
		 <p>Dilarang melakukan perubahan spesifikasi yang dapat menimbulkan gangguan fisik dan/atau elektromagnetik terhadap lingkungannya</p> 

Manufacturer	Model designation	Radio equipment approval number (if available)
Veoneer	77V12BSM (radar sensor)	66792/SDPPI/2020 7163  Dilarang melakukan perubahan spesifikasi yang dapat menimbulkan gangguan fisik dan/atau elektromagnetik terhadap lingkungan sekitarnya 

Manufacturer	Model designation	Radio equipment approval number (if available)
WITTE-Velbert	SDHTAG3N FC (locking system)	67233/SDPPI/2020 10325

Jamaica

Manufacturer	Model designation	Radio equipment approval number (if available)
Continental Automotive	CMKG1 (locking system)	SMA - CMKG1
HELLA	DM4 (locking system)	NBGDM4
MAR-QUARDT	DC12A (locking system)	SMA - DC12A
MAR-QUARDT	DC12B (locking system)	SMA - DC12B

Manufacturer	Model designation	Radio equipment approval number (if available)
MAR-QUARDT	DC12K (locking system)	SMA - DC12K
MAR-QUARDT	MS2 (locking system)	SMA - MS2
MAR-QUARDT	MS4 (locking system)	SMA - MS4
MAR-QUARDT	MS5 (locking system)	SMA - MS5
MAR-QUARDT	MK1 (locking system)	SMA - MK1
MAR-QUARDT	MK2 (locking system)	SMA - MK2
MAR-QUARDT	3350.38 (locking system)	SMA - 3350.38

Manufacturer	Model designation	Radio equipment approval number (if available)
MAR-QUARDT	MU1 (locking system)	SMA - MU1
WITTE-Velbert	SDHTAG3NFC (locking system)	SMA - DAG SDH TAG3 NFC

Jordan

Manufacturer	Model designation	Radio equipment approval number (if available)
ADC	ARS4-A (radar sensor)	TRC/LPD/2014/126
ADC	ARS4-B (radar sensor)	TRC/LPD/2014/248

Manufacturer	Model designation	Radio equipment approval number (if available)
ADC	ARS4-C (radar sensor)	T/4/11/11/6676
Bosch	FR5CPCCF (radar sensor)	T/4/11/11/6645
Bosch	LRR3 (radar sensor)	TRC/LPD/2009/15
Bosch	MRR1Rear (radar sensor)	TRC/LPD/2014/73
Bosch	MRRre14FCR (radar sensor)	TRC/LPD/2017/254
Continental Antenna	RKE213E1 (antenna amplifier)	T/4/11/11/6775

Manufacturer	Model designation	Radio equipment approval number (if available)
Continental Antenna	RKE223E1GNS (antenna amplifier)	T/4/11/11/9682
Continental Automotive	CMKG1 (locking system)	T/4/11/11/1799
Continental Automotive	MARS Keyless (locking system)	TRC/LPD/2017/183
Gentex	EUROII (convenience system)	TRC/LPD/2014/258
Gentex	MUAHL 5 (convenience system)	T/4/11/11/8462
HELLA	DM4 (locking system)	T/4/11/11/5472

430 Technical data

Manufacturer	Model designation	Radio equipment approval number (if available)
Hirschmann	920287A (locking system)	T/4/11/11/10883
Hirschmann	920287B (locking system)	TRC/LPD/2012/53
Huf Bao-long	TSSRE4A (tire pressure monitor sensor)	TRC/LPD/2017/421
Huf Bao-long	TSSSG4G6 (control unit) (tire pressure monitor sensor)	TRC/LPD/2017/422
Huf Bao-long	TSSSG4G6b (control unit) (tire pressure monitor sensor)	TRC/LPD/2017/175

Manufacturer	Model designation	Radio equipment approval number (if available)
HUF	HUF14632 (locking system)	T/4/11/11/4355
HUF	HUF4761 (locking system)	TRC/LPD/2012/144
LEOPOLD KOSTAL	KK1 (locking system)	T/4/11/11/8705
MAR-QUARDT	DC12A (locking system)	T/4/11/11/1899
MAR-QUARDT	DC12B (locking system)	T/4/11/11/9429

Manufacturer	Model designation	Radio equipment approval number (if available)
MAR-QUARDT	DC12K (locking system)	T/4/11/11/9430
MAR-QUARDT	MS2 (locking system)	T/4/11/11/6493
MAR-QUARDT	MS4 (locking system)	T/4/11/11/2512
MAR-QUARDT	MS5 (locking system)	T/4/11/11/3509
MAR-QUARDT	MK1 (locking system)	TRC/34/7629/2020

Manufacturer	Model designation	Radio equipment approval number (if available)
MAR-QUARDT	MK2 (locking system)	TRC/34/7630/2020
MAR-QUARDT	3350.38 (locking system)	T/4/11/11/7431
MAR-QUARDT	MU1 (locking system)	T/4/11/11/2511
Schrader	AG5SP4-D (tire pressure monitor sensor)	TRC/LPD/2019/21
Schrader	MFR (control unit) (tire pressure monitor sensor)	TRC/LPD/2019/184

Manufacturer	Model designation	Radio equipment approval number (if available)
Schrader	GG4T (tire pressure monitor sensor)	TRC/LPD/2017/456
Schrader	DG6W2D4 (tire pressure monitor sensor)	TRC/LPD/2018/139
Schrader	MC34MA4 (tire pressure monitor sensor)	TRC/LPD/2011/158
Veoneer	77V12BSM (radar sensor)	T/4/11/11/5557
Veoneer	77V12CRN (radar sensor)	T/4/11/11/5556

Manufacturer	Model designation	Radio equipment approval number (if available)
Veoneer	77GHz MMRV1 (radar sensor)	TRC/LPD/2015/161
WITTE-Velbert	SGHTAG3NFC (locking system)	T/4/11/11/2635

432 Technical data

Canada

Manufacturer	Model designation	Radio equipment approval number (if available)
ADC	ARS4-C (radar sensor)	IC: 4135A-ARS4C
Bosch	FR5CPCCF (radar sensor)	IC: 3887A-FR5CPCCF

Manufacturer	Model designation	Radio equipment approval number (if available)
Veoneer	77V12BSM (radar sensor)	IC: 8436B-77V12BSM
Veoneer	77V12CRN (radar sensor)	IC: 8436B-77V12CRN

Malaysia

		
Manufacturer	Model designation	Radio equipment approval number (if available)
ADC	ARS4-C (radar sensor)	SQASI/TA/19/2872
Bosch	FR5CPCCF (radar sensor)	CIDF 15000490
Bosch	LRR3 (radar sensor)	RALM/35A/0716/S(16-2324)



Manufacturer	Model designation	Radio equipment approval number (if available)
Bosch	MRR1Rear (radar sensor)	RALM/66 A/0618/S(18-2468)
Bosch	MRR14FCR (radar sensor)	RALM/45 A/0517/S(17-1576)



Manufacturer	Model designation	Radio equipment approval number (if available)
Continental Antenna	RKE213E1 (antenna amplifier)	RAUU/28 C/0915/S(15-2703)
Continental Antenna	RKE223E1GNS (antenna amplifier)	RDDK/34 B/1219/S(19-5319)



Manufacturer	Model designation	Radio equipment approval number (if available)
Continental Automotive	CMKG1 (locking system)	RFCP/13 A/0220/S(20-0197)
Continental Automotive	MARS Keyless (locking system)	RAAU/51 C/0417/S(17-1034) CIDF15000578



Manufacturer	Model designation	Radio equipment approval number (if available)
Continental Automotive	D-WMI2020A (control unit)	RGEZ/12 A/1019/S(19-4128)
HELLA	DM4 (locking system)	RDDK/41 A/0717/S(17-2269) CIDF15000578



Manufacturer	Model designation	Radio equipment approval number (if available)
Hirschmann	920287A (locking system)	RAUU/63 A/0311/S(11-0432)
Hirschmann	920287B (locking system)	RAUU/22 C/0615/S(15-1864)
Huf Bao-long	TSSRE4A (tire pressure monitor sensor)	CIDF17000184



Manufacturer	Model designation	Radio equipment approval number (if available)
Huf Bao-long	TSSSG4G6 (control unit) (tire pressure monitor sensor)	RAQP/57 A/0817/S(17-2424)
HUF	HUF14632 (locking system)	RAYN/25 A/0715/S(15-2385)



Manufacturer	Model designation	Radio equipment approval number (if available)
HUF	HUF4761 (locking system)	RAAU/16 B/1112/S(12-2053)
LEOPOLD KOSTAL	KK1 (locking system)	RAUU/27 C/0815/S(15-2953)



Manufacturer	Model designation	Radio equipment approval number (if available)
MAR-QUARDT	DC12A (locking system)	RDDK/33 A/0317/S(17-0669)
MAR-QUARDT	DC12B (locking system)	RAUU/62 A/0311/S(11-0263)



Manufacturer	Model designation	Radio equipment approval number (if available)
MAR-QUARDT	DC12K (locking system)	RAUU/62 A/0311/S(11-0264)
MAR-QUARDT	MS2 (locking system)	RDDK/31 A/0217/S(17-0405)

Manufacturer
Model designation
Radio equipment approval number (if available)

MAR-QUARDT

MS4 (locking system)

 RDDK/25
B/1019/
S(19-094
3)

MAR-QUARDT

MS5 (locking system)

 RGLO/02
A/0720/
S(20-258
0)

Manufacturer
Model designation
Radio equipment approval number (if available)

MAR-QUARDT

MK1 (locking system)

 RAAU/14
C/0615/
S(15-105
7)

MAR-QUARDT

MK2 (locking system)

 RAAU/12
C/0515/
S(15-105
9)

Manufacturer
Model designation
Radio equipment approval number (if available)

MAR-QUARDT

3350.38 (locking system)

 RDDK/17
B/0819/
S(19-108
2)

Meta System

ITS/TPS (interior protection)

 RAVG/18
Q/0212/
S(11-206
8)



Manufacturer	Model designation	Radio equipment approval number (if available)
Meta System	MUW II (interior protection)	RAVG/17 Q/0212/S(11-2067)
Schrader	AG5SP4-D (tire pressure monitor sensor)	RCDD/03A/0615/S(19-2094)



Manufacturer	Model designation	Radio equipment approval number (if available)
Schrader	MFR (control unit) (tire pressure monitor sensor)	RAQP/62 A/0419/S(19-1694)
Veoneer	77GHz MMRV1 (radar sensor)	RALM/31 A/0316/S(16-0727)
Veoneer	77V12BSM (radar sensor)	SQASI/T A/19/2980



Manufacturer	Model designation	Radio equipment approval number (if available)
Veoneer	77V12CRN (radar sensor)	SQASI/T A/19/2982
WITTE-Velbert	SDHTAG3NFC (locking system)	RDDK/43 B/0420/S(20-1749)

Morocco

Manufacturer	Model designation	Radio equipment approval number (if available)
		AGREE PAR L'ANRT MAROC
ADC	ARS4-A (radar sensor)	MR 9490 ANTR 2014-07-23
ADC	ARS4-B (radar sensor)	MR 9778 ANTR 2014-11-11
ADC	ARS4-C (radar sensor)	MR 20231 ANTR 2019
Bosch	FR5CPCCF (radar sensor)	MR 20575 ANTR 2019

Manufacturer	Model designation	Radio equipment approval number (if available)
Bosch	LRR3 (radar sensor)	MR 5371 ANTR 2010-02-02
Bosch	MRR1Rear (radar sensor)	MR 9186 ANTR 2014-04-22
Bosch	MRRre14FCR (radar sensor)	MR 13900 ANTR 2017-05-04
Continental Antenna	RKE213E1 (antenna amplifier)	MR 10631 ANTR 2015-07-16
Continental Antenna	RKE223E1GNS (antenna amplifier)	MR 21174 ANTR 2019-10-14

Manufacturer	Model designation	Radio equipment approval number (if available)
Continental Automotive	CMKG1 (locking system)	MR 21701 ANTR 2019-12-05
Continental Automotive	MARS Keyless (locking system)	MR 13681 ANTR 2017-04-04
HELLA	DM4 (locking system)	MR 14426 ANTR 2017-07-28
Hirschmann	920287A (locking system)	MR 6700 ANTR 2011-11-16
Hirschmann	920287B (locking system)	MR 7260 ANTR 2012-06-13

Manufacturer	Model designation	Radio equipment approval number (if available)	Manufacturer	Model designation	Radio equipment approval number (if available)	Manufacturer	Model designation	Radio equipment approval number (if available)
Huf Bao-long	TSSRE4A (tire pressure sensor) (tire pressure monitor sensor)	MR 14320 ANTR 2017-07-07	HUF	HUF4761 (locking system)	MR 7829 ANTR 2013-02-14	MAR-QUARDT	MS2 (locking system)	MR 13300 ANTR 2017-02-15
Huf Bao-long	TSSSG4G6 (control unit) (tire pressure monitor sensor)	MR 14319 ANTR 2017-07-07	LEOPOLD KOSTAL	KK1 (locking system)	MR 10697 ANTR 2015-08-05	MAR-QUARDT	MS4 (locking system)	MR 19199 ANTR 2019-03-25
Huf Bao-long	TSSSG4G6b (control unit) (tire pressure monitor sensor)	MR 19561 ANTR 2019-04-26	MAR-QUARDT	DC12A (locking system)	MR 13429 ANTR 2017-03-03	MAR-QUARDT	MS5 (locking system)	MR 23805 ANTR 22/04/2020
HUF	HUF14632 (locking system)	MR 10506 ANTR 2015-06-22	MAR-QUARDT	DC12B (locking system)	MR 6698 ANTR 2011-11-16	MAR-QUARDT	MK1 (locking system)	MR 10645 ANTR 2015-07-21
			MAR-QUARDT	DC12K (locking system)	MR 6699 ANTR 2011-11-16	MAR-QUARDT	MK2 (locking system)	MR 10987 ANTR 2015-10-22

440 Technical data



Manufacturer	Model designation	Radio equipment approval number (if available)
MAR-QUARDT	3350.38 (locking system)	MR 18817 ANTR 2019-02-12
MAR-QUARDT	MU1 (locking system)	MR 19200 ANTR 2019-03-25
MAR-QUARDT	MU2 (locking system)	MR 23804 ANRT 22/04/2020
Schrader	AG5SP4-D (tire pressure sensor) (tire pressure monitor sensor)	MR 10216 ANTR 2015-03-18



Manufacturer	Model designation	Radio equipment approval number (if available)
Schrader	MFR (control unit) (tire pressure monitor sensor)	MR 19527 ANTR 2019-04-30
Schrader	GG4T (tire pressure monitor sensor)	MR 14777 ANRT 2017-09-20
Schrader	DG6W2D4 (tire pressure monitor sensor)	MR 16355 ANTR 2018-04-19
Schrader	MC34MA4 (tire pressure monitor sensor)	MR 6706 ANTR 2011-11-17
Veoneer	77GHz MMRV1 (radar sensor)	MR 10436 ANTR 2015

Manufacturer	Model designation	Radio equipment approval number (if available)
Veoneer	77V12BSM (radar sensor)	MR 20097 ANTR 2019
Veoneer	77V12CRN (radar sensor)	MR 20149 ANTR 2019
WITTE-Velbert	SDHTAG3NFC (locking system)	MR 23310 ANRT 10/03/2020



Mexico



		
Manufacturer	Model designation	Radio equipment approval number (if available)
ADC	ARS4-A (radar sensor)	IFETEL: RCPCOAR14-11 91
ADC	ARS4-B (radar sensor)	IFETEL: RLVCOAR15-00 08
ADC	ARS4-C (radar sensor)	IFETEL: RLVCOR19-106 2
Bosch	FR5CPCCF (radar sensor)	IFETEL: RCPBOFR19-13 56



		
Manufacturer	Model designation	Radio equipment approval number (if available)
Bosch	LRR3 (radar sensor)	IFETEL: RCPBOLR09-08 28
Bosch	MRR1Rear (radar sensor)	IFETEL: RCPBOMR14-0 922
Bosch	MRRre14FCR (radar sensor)	IFETEL: RCPBOMR17-0 598
Continental Antenna	RKE213E1 (antenna amplifier)	IFETEL: RLVKARK15-17 41



		
Manufacturer	Model designation	Radio equipment approval number (if available)
Continental Antenna	RKE223E1 (antenna amplifier)	IFETEL: RLVCORK19-21 74
Continental Automotive	CMKG1 (locking system)	IFETEL: RCPCCOM19-2 315
Continental Automotive	MARS Keyless (locking system)	IFETEL: RLVDAMA18-1 827
Gentex	EURO II (convenience system)	IFETEL: RCPJOHO07-59 8-A9



		
Manufacturer	Model designation	Radio equipment approval number (if available)
Gentex	MUAHL 5 (convenience system)	IFETEL: RCPGEMU15-0448
HELLA	DM4 (locking system)	IFETEL: RLVHEDM17-10
Hirschmann	920287A (locking system)	IFETEL: RLVHI9211-0472
Hirschmann	920287B (locking system)	IFETEL: RLVHI9212-0608



		
Manufacturer	Model designation	Radio equipment approval number (if available)
Huf Baolong	TSSRE4A (tire pressure monitor sensor)	IFETEL: RLVHUTS17-0806
HUF	HUF14632 (locking system)	IFETEL: RLVHUHU15-1204
HUF	HUF4761 (locking system)	IFETEL: RLVHUHU12-1587
LEOPOLD KOSTAL	KK1 (locking system)	IFETEL: RLVKOKK15-0891



		
Manufacturer	Model designation	Radio equipment approval number (if available)
MAR-QUARDT	DC12A (locking system)	IFETEL: RLVMEDC17-0348
MAR-QUARDT	DC12B (locking system)	IFETEL: RLVMAADC11-0446
MAR-QUARDT	DC12K (interior protection)	IFETEL: RLVMAADC11-0446
MAR-QUARDT	MS2 (locking system)	IFETEL: RLVMAAMS17-0222

 		
Manufacturer	Model designation	Radio equipment approval number (if available)
MAR-QUARDT	MS4 (locking system)	IFETEL: RLVMAMS19-0449
MAR-QUARDT	MS5 (locking system)	IFETEL: RLVMEMS20-0957
MAR-QUARDT	MK1 (locking system)	IFETEL: RLVMAMK15-1042
MAR-QUARDT	MK2 (locking system)	IFETEL: RLVMAMK15-1043

 		
Manufacturer	Model designation	Radio equipment approval number (if available)
MAR-QUARDT	3350.38 (locking system)	IFETEL: RCPMA3319-0530
MAR-QUARDT	MU1 (locking system)	IFETEL: RCPMAMU19-1342
Meta System	ITS/TPS (interior protection)	IFETEL: IFT/223/UCS/ DG-AUSE/ 4871/2016
Meta System	MUW II (interior protection)	IFETEL: IFT/223/UCS/ DG-AUSE/ 5064/2016

 		
Manufacturer	Model designation	Radio equipment approval number (if available)
Schrader	AG5SP4-D (tire pressure monitor sensor)	IFETEL: RCPSCAG15-0627
Schrader	MFR (tire pressure monitor sensor)	IFETEL: RLVSCMF15-0959
Schrader	GG4T (tire pressure monitor sensor)	IFETEL: RLVSCGG17-1665

 NOM	 NYCE	
Manufacturer	Model designation	Radio equipment approval number (if available)
Schrader	DG6W2D4 (tire pressure monitor sensor)	IFETEL: RLVSCDG18-04
Schrader	MC34MA4 (tire pressure monitor sensor)	IFETEL: RCPSCMR14-062
Veoneer	77GHz MMRV1 (radar sensor)	IFETEL: RLVAU7717-0744

 NOM	 NYCE	
Manufacturer	Model designation	Radio equipment approval number (if available)
Veoneer	77V12BSM (radar sensor)	IFETEL: RLVVE7719-1063
Veoneer	77V12CRN (radar sensor)	IFETEL: RCPVE7719-0998
WITTE-Velbert	SDHTAG3NFC (locking system)	IFETEL: RCPWISD20-0943

Moldova

		
Manufacturer	Model designation	Radio equipment approval number (if available)
ADC	ARS4-C (radar sensor)	MD OC TIP 024 A6632-19
Bosch	FR5CPCCF (radar sensor)	MD OC TIP 024 A6560-19
Bosch	LRR3 (radar sensor)	MD OC TIP 024 A6227-18
Bosch	MRR1Rear (radar sensor)	MD OC TIP 024 A5957-17



Manufacturer	Model designation	Radio equipment approval number (if available)
Bosch	MRRre 14FCR (radar sensor)	MD OC TIP 024 A6004-18
Continental Antenna	RKE213E1 (antenna amplifier)	MD OC TIP 024 A6500-19
Continental Antenna	RKE223E1G NS (antenna amplifier)	MD OC TIP 024 A6648-19
Continental Automotive	CMKG1 (locking system)	MD OC TIP 024 A6671-20



Manufacturer	Model designation	Radio equipment approval number (if available)
Continental Automotive	MARS Keyless (locking system)	MD OC TIP 024 A5876-17
HELLA	DM4 (locking system)	MD OC TIP 024 A6761-20
Hirschmann	920287A (locking system)	MD OC TIP 024 A6652-20
Hirschmann	920287B (locking system)	MD OC TIP 024 A6514-19



Manufacturer	Model designation	Radio equipment approval number (if available)
HUF	HUF4761 (locking system)	MD OC TIP 024 A6449-19
LEOPOLD KOSTAL	KK 1 (locking system)	MD OC TIP 024 A6440-19
MAR-QUARDT	DC 12A (locking system)	MD OC TIP 024 A6684-20
MAR-QUARDT	DC 12B (locking system)	MD OC TIP 024 A6253-18
MAR-QUARDT	DC 12K (locking system)	MD OC TIP 024 A6252-18



Manufacturer	Model designation	Radio equipment approval number (if available)
MAR-QUARDT	MS2 (locking system)	MD OC TIP 024 A6444-19
MAR-QUARDT	MS4 (locking system)	MD OC TIP 024 A6569-19
MAR-QUARDT	MS5 (locking system)	MO OC TIP 024 A6774-20
MAR-QUARDT	MK1 (locking system)	MD OC TIP 024 A6551-19
MAR-QUARDT	MK2 (locking system)	MD OC TIP 024 A6552-19





Manufacturer	Model designation	Radio equipment approval number (if available)
MAR-QUARDT	3350.38 (locking system)	MD OC TIP 024 A6398-19
MAR-QUARDT	MU1 (locking system)	MD OC TIP 024 A6570-19
MAR-QUARDT	MU2 (locking system)	MD OC TIP 024 A6773-20
Veoneer	77GHz MMRV1 (radar sensor)	MD OC TIP 024 A5678-16



Manufacturer	Model designation	Radio equipment approval number (if available)
Veoneer	77V12BSM (radar sensor)	MD OC TIP 024 A6508-19
Veoneer	77V12CRN (radar sensor)	MD OC TIP 024 A6506-19
WITTE-Velbert	SDHTAG3NFC (locking system)	MD OC TIP 024 A6753-20

Mongolia

		
Manufacturer	Model designation	Radio equipment approval number (if available)
Continental Automotive	CMKG1 (locking system)	A19000633
Continental Automotive	MARS Keyless (locking system)	A18000328
HELLA	DM4 (locking system)	A18000329
MAR-QUARDT	DC12A (locking system)	A19000400
MAR-QUARDT	DC12B (locking system)	A19000371

		
Manufacturer	Model designation	Radio equipment approval number (if available)
MAR-QUARDT	DC12K (locking system)	A19000372
MAR-QUARDT	MS2 (locking system)	A19000289
MAR-QUARDT	MS4 (locking system)	A19000516
MAR-QUARDT	MS5 (locking system)	A20000085
MAR-QUARDT	MK1 (locking system)	A19000374
MAR-QUARDT	MK2 (locking system)	A19000374

		
Manufacturer	Model designation	Radio equipment approval number (if available)
MAR-QUARDT	MU1 (locking system)	A19000517
MAR-QUARDT	MU2 (locking system)	A20000086
WITTE-Velbert	SDHTAG3NFC (locking system)	A20000067

Niger

Manufacturer	Model designation	Radio equipment approval number (if available)
Continental Antenna	RKE213E1 (antenna amplifier)	029/ARCEP/DG/19
Continental Automotive	MARS Keyless (locking system)	083/ARCEP/DG/19
HELLA	DM4 (locking system)	082/ARCEP/DG/19
Hirschmann	920287A (locking system)	097/ARCEP/DG/19
Hirschmann	920287B (locking system)	098/ARCEP/DG/19

Manufacturer	Model designation	Radio equipment approval number (if available)
HUF	HUF4761 (locking system)	053/ARCEP/DG/19
KATHREIN	RKE213E1 (locking system)	029/ARCEP/DG/19
LEOPOLD KOSTAL	KK 1 (locking system)	037/ARCEP/DG/19
MAR-QUARDT	DC 12A (locking system)	010/ARCEP/DG/19
MAR-QUARDT	DC 12B (locking system)	008/ARCEP/DG/19
MAR-QUARDT	DC 12K (locking system)	009/ARCEP/DG/19

Manufacturer	Model designation	Radio equipment approval number (if available)
MAR-QUARDT	MS2 (locking system)	014/ARCEP/DG/19
MAR-QUARDT	MS4 (locking system)	HOMO-0096/ARCEP/DG/2019
MAR-QUARDT	MK1 (locking system)	034/ARCEP/DG/19
MAR-QUARDT	MK2 (locking system)	035/ARCEP/DG/19
MAR-QUARDT	3350.38 (locking system)	015/ARCEP/DG/19
MAR-QUARDT	MU1 (locking system)	HOMO-0095/ARCEP/DG/2019

Nigeria

Manufacturer	Model designation	Radio equipment approval number (if available)
ADC	ARS4-A (radar sensor)	NCC/TSNI/WN/TA/CERT/AB00388/2015
ADC	ARS4-B (radar sensor)	NCC/TSNI/WN/TA/CERT/2062/2018
ADC	ARS4-C (radar sensor)	NCC/TSNI/WN/TA/CERT/3078/2019
Bosch	FR5CPCCF (radar sensor)	NCC/TSNI/WN/TA/CERT/3282/2019

Manufacturer	Model designation	Radio equipment approval number (if available)
Bosch	MRR1Rear (radar sensor)	NCC/TSNI/WN/TA/CERT/2089/2018
Bosch	MRRre14FC R (radar sensor)	NCC/TSNI/WN/TA/CERT/2042/2018
Continental Antenna	RKE213E1 (antenna amplifier)	NCC/TSNI/WN/TA/CERT/0865/2015
Continental Antenna	RKE223E1G NS (antenna amplifier)	NCC/TSNI/WN/TA/CERT/3372/2020

Manufacturer	Model designation	Radio equipment approval number (if available)
Continental Automotive	CMKG1 (locking system)	NCC/TSNI/WN/TA/CERT/3440/2020
Continental Automotive	MARS Keyless (locking system)	NCC/TSNI/WN/TA/CERT/1670/2017
HELLA	DM4 (locking system)	NCC/TSNI/WN/TA/CERT/1830/2017
Hirschmann	920287A (locking system)	NCC/TSNI/WN/TA/CERT/3100/2019

450 Technical data

Manufacturer	Model designation	Radio equipment approval number (if available)
Hirschmann	920287B (locking system)	NCC/TSNI/WN/TA/CERT/3101/2019
HUF	HUF14632 (locking system)	NCC/TSNI/WN/TA/CERT/0829/2015
HUF	HUF4761 (locking system)	NCC/TSNI/WN/TA/CERT/2884/2019
LEOPOLD KOSTAL	KK1 (locking system)	NCC/TSNI/WN/TA/CERT/0823/2015

Manufacturer	Model designation	Radio equipment approval number (if available)
MAR-QUARDT	DC12A (locking system)	NCC/TSNI/WN/TA/CERT/1714/2017
MAR-QUARDT	DC12B (locking system)	NCC/TSNI/WN/TA/CERT/2627/2019
MAR-QUARDT	DC12K (locking system)	NCC/TSNI/WN/TA/CERT/2626/2019
MAR-QUARDT	MS2 (locking system)	NCC/TSNI/WN/TA/CERT/1667/2017

Manufacturer	Model designation	Radio equipment approval number (if available)
MAR-QUARDT	MS4 (locking system)	NCC/TSNI/WN/TA/CERT/3212/2019
MAR-QUARDT	MS5 (locking system)	NCC/TSNI/WN/TA/CERT/3635/2020
MAR-QUARDT	MK1 (locking system)	NCC/TSNI/WN/TA/CERT/0739/2015
MAR-QUARDT	MK2 (locking system)	NCC/TSNI/WN/TA/CERT/0740/2015

Manufacturer	Model designation	Radio equipment approval number (if available)
MAR-QUARDT	3350.38 (locking system)	NCC/TSNI/WN/TA/CERT/2882/2019
Veoneer	77V12BSM (radar sensor)	NCC/TSNI/WN/TA/CERT/3069/2019
Veoneer	77V12CRN (radar sensor)	NCC/TSNI/WN/TA/CERT/3068/2019
WITTE-Velbert	SDHTAG3N FC (locking system)	NCC/TSNI/WN/TA/CERT/3671/2020

Oman

Manufacturer	Model designation	Radio equipment approval number (if available)
ADC	ARS4-A (radar sensor)	TRA/TA-R/2016/14 D080134
ADC	ARS4-B (radar sensor)	TRA/TA-R/2210/14 D080134
ADC	ARS4-C (radar sensor)	TRA/TA-R/7769/19 D172338
Bosch	FR5CPCCF (radar sensor)	TRA/TA-R/7983/19 D172338
Bosch	LRR3 (radar sensor)	TRA/TA-R/1049/09

Manufacturer	Model designation	Radio equipment approval number (if available)
Bosch	MRR1Rear (radar sensor)	TRA/TA-R/1849/14
Bosch	MRR14FCR (radar sensor)	TRA/TA-R/4353/17
Continental Antenna	RKE213E1 (antenna amplifier)	TRA/TA-R/2715/15 D090258
Continental Antenna	RKE223E1GNS (antenna amplifier)	TRA/TA-R/8337/19
Continental Automotive	CMKG1 (locking system)	TRA/TA-R/8642/19 D172338

Manufacturer	Model designation	Radio equipment approval number (if available)
Continental Automotive	MARS Keyless (locking system)	TRA/TA-R/4158/17 D080134
HELLA	DM4 (locking system)	TRA/TA-R/4548/17 D080134
Hirschmann	920287A (locking system)	TRA/TA-R/0210/11 D080353
Hirschmann	920287B (locking system)	TRA/TA-R/0655/12 D080353
Huf Bao-long	TSSRE4A (tire pressure monitor sensor)	TRA R/4516/17 D100428

Manufacturer	Model designation	Radio equipment approval number (if available)
Huf Bao-long	TSSSG4G6 (tire pressure monitor sensor)	TRA R/4515/17 D100428
Huf Bao-long	TSSSG4G6b (tire pressure monitor sensor)	TRA R/7506/19 D100428
HUF	HUF14632 (locking system)	TRA/TA-R/2665/15
HUF	HUF4761 (locking system)	TRA/TA-R/0920/12
LEOPOLD KOSTAL	KK1 (locking system)	TRA/TA-R/3129/16
MAR-QUARDT	DC12A (locking system)	TRA/TA-RD/4056/17 D100428

Manufacturer	Model designation	Radio equipment approval number (if available)
MAR-QUARDT	DC12B (locking system)	TRA/TA-R/0227/11 D080353
MAR-QUARDT	DC12K (locking system)	TRA/TA-R/0228/11 D080353
MAR-QUARDT	MS2 (locking system)	TRA/TA-R/4136/17 D080134
MAR-QUARDT	MS4 (locking system)	TRA/TA-R/7316/19 D172249
MAR-QUARDT	MS5 (locking system)	TRA/TA-R/9324/20 D100428

Manufacturer	Model designation	Radio equipment approval number (if available)
MAR-QUARDT	MK1 (locking system)	TRA/TA-R/ 2848/15 D080353
MAR-QUARDT	MK2 (locking system)	TRA/TA-R/ 2900/15 D080353
MAR-QUARDT	3350.38 (locking system)	TRA/TA-R/ 7051/19 D172249
MAR-QUARDT	MU1 (locking system)	TRA/TA-R/ 7353/19 D172249
MAR-QUARDT	MU2 (locking system)	TRA/TA-R/ 9325/20 D100428

Manufacturer	Model designation	Radio equipment approval number (if available)
Schrader	AG5SP4-D (tire pressure monitor sensor)	TRA R/ 2380/15 D080134
Schrader	MFR (tire pressure monitor sensor)	TRA R/ 7464/19 D090258
Schrader	GG4T (tire pressure monitor sensor)	TRA TA-R/ 4686/17 D080134
Schrader	DG6W2D4 (tire pressure monitor sensor)	TRA TA-R/ 5511/18 D172249
Veoneer	77GHz MMRV1 (radar sensor)	TRA/TA-R/ 2706/15

Manufacturer	Model designation	Radio equipment approval number (if available)
Veoneer	77V12BSM (radar sensor)	TRA R/ 7706/19 D172338
Veoneer	77V12CRN (radar sensor)	TRA R/ 7707/19 D172338
WITTE-Velbert	SDHTAG3NFC (locking system)	TRA/TA-R/ 9150/20

Pakistan

		
Manufacturer	Model designation	Radio equipment approval number (if available)
ADC	ARS4-A (radar sensor)	TAC NO: 9.9014/2019
ADC	ARS4-B (radar sensor)	TAC NO: 9.1048/2018
ADC	ARS4-C (radar sensor)	TAC NO: 9.9389/2019
Bosch	FR5CPCCF (radar sensor)	TAC NO: 9.198/2020
Continental Antenna	RKE213E1 (antenna amplifier)	TAC NO: 9.142/2016

		
Manufacturer	Model designation	Radio equipment approval number (if available)
Continental Antenna	RKE223E1GNS (antenna amplifier)	TAC NO: 9.100169/2019
Continental Automotive	CMKG1 (locking system)	TAC NO: 9.100175/2019
Continental Automotive	MARS Keyless (locking system)	TAC NO: 9.213/2017
Continental Automotive	D-WMI2020A (control unit)	TAC NO: 9.9836/2019

		
Manufacturer	Model designation	Radio equipment approval number (if available)
HELLA	DM4 (locking system)	TAC NO: 9.409/2017
Hirschmann	920287A (locking system)	TAC NO: 9.845/2013
Hirschmann	920287B (locking system)	TAC NO: 9.846/2013
HUF	HUF14632 (locking system)	TAC NO: 9.598/2015



Manufacturer	Model designation	Radio equipment approval number (if available)
HUF	HUF4761 (locking system)	TAC NO: 9.790/2013
LEOPOLD KOSTAL	KK1 (locking system)	TAC NO: 9.118/2016
MAR-QUARDT	DC12A (locking system)	TAC NO: 9.131/2017
MAR-QUARDT	DC12B (locking system)	TAC NO: 9.829/2013
MAR-QUARDT	DC12K (locking system)	TAC NO: 9.830/2013





Manufacturer	Model designation	Radio equipment approval number (if available)
MAR-QUARDT	MS2 (locking system)	TAC NO: 9.133/2017
MAR-QUARDT	MS4 (locking system)	TAC NO: 9.100171/2019
MAR-QUARDT	MS5 (locking system)	TAC.NO: 9.774/2020
MAR-QUARDT	MK1 (locking system)	TAC NO: 9.486/2015
MAR-QUARDT	MK2 (locking system)	TAC NO: 9.497/2015





Manufacturer	Model designation	Radio equipment approval number (if available)
MAR-QUARDT	MU1 (locking system)	TAC NO: 9.100170/2019
MAR-QUARDT	MU2 (locking system)	TAC NO: 9.785/2020
Veoneer	77GHz MMRV1 (radar sensor)	TAC NO: 9.9284/2019
Veoneer	77V12BSM (radar sensor)	TAC NO: 9.9391/2019
Veoneer	77V12CRN (radar sensor)	TAC NO: 9.9391/2019

Paraguay

 CONATEL	Manufacturer	Model designation	Radio equipment approval number (if available)
	ADC	ARS4-A (radar sensor)	2019-05-I-0271
	ADC	ARS4-B (radar sensor)	2019-07-I-0353
	ADC	ARS4-C (radar sensor)	2019-11-I-0602
	Bosch	FR5CPCCF (radar sensor)	2019-09-I-0508

 CONATEL	Manufacturer	Model designation	Radio equipment approval number (if available)
	Bosch	MRR14FCR (radar sensor)	2017-06-I-0000162
	Bosch	MRR1Rear (radar sensor)	2019-05-I-000236
	Continental Antenna	RKE213E1 (antenna amplifier)	2016-02-I-0000038
	Continental Antenna	RKE223E1GNS (antenna amplifier)	2019-12-I-0656

 CONATEL	Manufacturer	Model designation	Radio equipment approval number (if available)
	Continental Automotive	CMKG1 (locking system)	2020-02-I-0110
	Continental Automotive	MARS Keyless (locking system)	2017-05-I-0000136

		
Manufacturer	Model designation	Radio equipment approval number (if available)
Continental Automotive	D-WMI2020A (control unit)	Este vehículo posee el siguiente componente de radio-frecuencias, homologado por la CONATEL – Paraguay: Interfaz inalámbrica para móvil, Marca Continental, modelo D-WMI2020A Fabricado por Continental Automotive GmbH

		
Manufacturer	Model designation	Radio equipment approval number (if available)
		2019-11-I-0600
HELLA	DM4 (locking system)	2017-08-I_0000261
Hirschmann	920287A (locking system)	2016-5-I-000134 y 2011-06-I-0059
Hirschmann	920287B (locking system)	2017-04-I-0000119 y 2012-05-I-0096
Huf Baolong	TSSRE4A (tire pressure monitor sensor)	2017-09-I-0000328

		
Manufacturer	Model designation	Radio equipment approval number (if available)
HUF	HUF14632 (locking system)	2020-06-I-0284 y 2015-08-I-0000226
HUF	HUF4761 (locking system)	2017-12-I-0000409 y 2012-10-I-0178
LEOPOLD KOSTAL	KK1 (locking system)	2015-06-I-0000181
MAR-QUARDT	DC12A (locking system)	2017-07-I-0000199

		
Manufacturer	Model designation	Radio equipment approval number (if available)
MAR-QUARDT	DC12B (locking system)	2016-5-I-000144 y 2011-06-I-0067
MAR-QUARDT	DC12K (locking system)	2016-5-I-000143 y 2011-06-I-0068
MAR-QUARDT	MS2 (locking system)	2017-04-I-0000101
MAR-QUARDT	MS4 (locking system)	2019-10-I-0581
MAR-QUARDT	MS5 (locking system)	2020-08-I-0604

		
Manufacturer	Model designation	Radio equipment approval number (if available)
MAR-QUARDT	MK1 (locking system)	2020-07-I-0390 y 2015-07-I-0000200
MAR-QUARDT	MK2 (locking system)	2020-07-I-0391 y 2015-07-I-0000201
MAR-QUARDT	3350.38 (locking system)	2019-04-I-000216

		
Manufacturer	Model designation	Radio equipment approval number (if available)
Panasonic	DAIRSE	Importer: Condor S.A.C.I Casa Central, J.B. Gorostiaga 315 y Guaraníes, Asunción, Parag- way, (595 21) 569 7000, sac@con- dor.com.py
Schrader	AG5SP4-D (tire pressure monitor sensor)	2015-04-I-0000150



Manufacturer	Model designation	Radio equipment approval number (if available)
Veoneer	77GHz MMRV1 (radar sensor)	2015-07-I-000194
Veoneer	77V12BSM (radar sensor)	2019-07-I-0399
Veoneer	77V12CRN (radar sensor)	2019-07-I-0398
WITTE-Velbert	SDHTAG3N FC (locking system)	2020-06-I-0326

Philippines



Manufacturer	Model designation	Radio equipment approval number (if available)
ADC	ARS4-A (radar sensor)	ESD-1409466C
ADC	ARS4-B (radar sensor)	ESD-1409834C
ADC	ARS4-C (radar sensor)	ESD-1920226C
Bosch	FR5CPCCF (radar sensor)	ESD-1920531C



Manufacturer	Model designation	Radio equipment approval number (if available)
Bosch	MRR1Rear (radar sensor)	ESD-1408917C
Bosch	MRRe14FCR (radar sensor)	ESD-1716172C
Veoneer	77V12BSM (radar sensor)	ESD-1920160C
Veoneer	77V12CRN (radar sensor)	ESD-1920162C



Manufacturer	Model designation	Radio equipment approval number (if available)
Veoneer	77GHz MMRV1 (radar sensor)	ESD-1510921C
Schrader	AG5SP4-D (tire pressure monitor sensor)	ESD-1510376C
Continental Antenna	RKE213E1 (antenna amplifier)	ESD-1511856C
Continental Antenna	RKE223E1GN S (antenna amplifier)	ESD-1921015C



Manufacturer	Model designation	Radio equipment approval number (if available)
Continental Automotive	CMKG1 (locking system)	ESD-2021556C
Continental Automotive	MARS Keyless (locking system)	ESD-1714865C
HELLA	DM4 (locking system)	ESD-1715539C
Hirschmann	920287A (locking system)	ESD-1105246C
Hirschmann	920287B (locking system)	ESD-1206044C



Manufacturer	Model designation	Radio equipment approval number (if available)
Huf Bao-long	TSSRE4A (tire pressure monitor sensor)	ESD-1715393C
HUF	HUF14632 (locking system)	ESD-1511236C
HUF	HUF4761 (locking system)	ESD-1206521C
LEOPOLD KOSTAL	KK1 (locking system)	ESD-1510698C



Manufacturer	Model designation	Radio equipment approval number (if available)
MAR-QUARDT	DC12A (locking system)	ESD-1714489C
MAR-QUARDT	DC12B (locking system)	ESD-1105216C
MAR-QUARDT	DC12K (locking system)	ESD-1105215C
MAR-QUARDT	MS2 (locking system)	ESD-1715652C
MAR-QUARDT	MS4 (locking system)	ESD-1919133C
MAR-QUARDT	MS5 (locking system)	ESD-2022426C





Manufacturer	Model designation	Radio equipment approval number (if available)
MAR-QUARDT	MK1 (locking system)	ESD-1510644C
MAR-QUARDT	MK2 (locking system)	ESD-1510645C
MAR-QUARDT	3350.38 (locking system)	ESD-1919198C
MAR-QUARDT	MU1 (locking system)	ESD-1919146C
WITTE-Velbert	SDHTAG3NFC (locking system)	ESD-2022599C

Zambia



Manufacturer	Model designation	Radio equipment approval number (if available)
Continental Antenna	RKE213E1 (antenna amplifier)	ZMB/ZICTA/TA/2019/3/11
Continental Automotive	MARS Keyless (locking system)	ZMB/ZICTA/TA/2019/3/3
HELLA	DM4 (locking system)	ZMB/ZICTA/TA/2019/3/4
Hirschmann	920287A (locking system)	ZMB/ZICTA/TA/2019/7/12

		
Manufacturer	Model designation	Radio equipment approval number (if available)
Hirschmann	920287B (locking system)	ZMB/ZICTA/TA/2019/7/11
HUF	HUF4761 (locking system)	ZMB/ZICTA/TA/2018/12/18
LEOPOLD KOSTAL	KK1 (locking system)	ZMB/ZICTA/TA/2019/3/48
MAR-QUARDT	DC12A (locking system)	ZMB/ZICTA/TA/2019/5/16

		
Manufacturer	Model designation	Radio equipment approval number (if available)
MAR-QUARDT	DC12B (locking system)	ZMB/ZICTA/TA/2019/5/17
MAR-QUARDT	DC12K (locking system)	ZMB/ZICTA/TA/2019/5/18
MAR-QUARDT	MS2 (locking system)	ZMB/ZICTA/TA/2018/9/30
MAR-QUARDT	MS4 (locking system)	ZMB/ZICTA/TA/2019/7/123
MAR-QUARDT	MK1 (locking system)	ZMB/ZICTA/TA/2019/3/20

		
Manufacturer	Model designation	Radio equipment approval number (if available)
MAR-QUARDT	MK2 (locking system)	ZMB/ZICTA/TA/2019/3/21
MAR-QUARDT	3350.38 (locking system)	ZMB/ZICTA/TA/2019/3/6
MAR-QUARDT	MU1 (locking system)	ZMB/ZICTA/TA/2019/7/124
Veoneer	77V12BSM (radar sensor)	ZMB/ZICTA/TA/2019/6/59
Veoneer	77V12CRN (radar sensor)	ZMB/ZICTA/TA/2019/6/60

Serbia

		
Manufacturer	Model designation	Radio equipment approval number (if available)
ADC	ARS4-A (radar sensor)	И011 14
ADC	ARS4-B (radar sensor)	И011 14
ADC	ARS4-C (radar sensor)	И011 14 34540-328/1 9-3
Bosch	FR5CPCCF (radar sensor)	И01119 34540-400/1 9-04

		
Manufacturer	Model designation	Radio equipment approval number (if available)
Bosch	LRR3 (radar sensor)	1-06-3454-19 0/09
Bosch	MRR1Rear (radar sensor)	34540-840/1 7-3
Bosch	MRRe14FCR (radar sensor)	P1617068100
Continental Antenna	RKE213E1 (antenna amplifier)	И005 18 P1618107600
Continental Antenna	RKE223E1GN S (antenna amplifier)	И005 19 P1619151300

		
Manufacturer	Model designation	Radio equipment approval number (if available)
Continental Automotive	CMKG1 (locking system)	И005 20 P1620007300
Continental Automotive	MARS Keyless (locking system)	И005 17 P1617052600
Gentex	EURO II (convenience system)	И005 14 P1614085200
HELLA	DM4 (locking system)	И005 20 P1620100100



Manufacturer	Model designation	Radio equipment approval number (if available)
Hirschmann	920287A (locking system)	I005 18 P1618084500
Hirschmann	920287B (locking system)	I005 18 P1618084400
Huf Baolong	TSSRE4A (tire pressure monitor sensor)	I005 17



Manufacturer	Model designation	Radio equipment approval number (if available)
Huf Baolong	TSSSG4G6 (tire pressure monitor sensor)	I005 17
Huf Baolong	TSSSG4G6b (tire pressure monitor sensor)	I005 19
HUF	HUF14632 (locking system)	I005 18 P1618104600



Manufacturer	Model designation	Radio equipment approval number (if available)
HUF	HUF4761 (locking system)	I005 18 P1618156300
LEOPOLD KOSTAL	KK1 (locking system)	I005 18 P1618080200
MAR-QUARDT	DC12A (locking system)	I005 20 P1620044700
MAR-QUARDT	DC12B (locking system)	I005 20 P1620124700
MAR-QUARDT	DC12K (locking system)	I005 20 P1620124800



Manufacturer	Model designation	Radio equipment approval number (if available)
MAR-QUARDT	MS2 (locking system)	И011 17 34540-88/20-10
MAR-QUARDT	MS4 (locking system)	И005 19 P1619129100
MAR-QUARDT	MS5 (locking system)	И005 20 P1620062300
MAR-QUARDT	MK1 (locking system)	34540-306/1 8-3
MAR-QUARDT	MK2 (locking system)	34540-304/1 8-3



Manufacturer	Model designation	Radio equipment approval number (if available)
MAR-QUARDT	3350.38 (locking system)	34540-124/19 -5
MAR-QUARDT	MU1 (locking system)	И005 19 P1619129200
Meta System	MUW II (interior protection)	И011 19 P1619045500
Schrader	AG5SP4-D (tire pressure monitor sensor)	И005 15



Manufacturer	Model designation	Radio equipment approval number (if available)
Schrader	MFR (tire pressure monitor sensor)	И005 19
Schrader	GG4T (tire pressure monitor sensor)	И005 17
Schrader	DG6W2D4 (tire pressure monitor sensor)	И005 18



Manufacturer	Model designation	Radio equipment approval number (if available)
Schrader	MC34MA4 (tire pressure monitor sensor)	I011 11
Veoneer	77GHz MMRV1 (radar sensor)	I011 18 34540-483/1 8-3
Veoneer	77V12BSM (radar sensor)	34540-327/1 9-6



Manufacturer	Model designation	Radio equipment approval number (if available)
Veoneer	77V12CRN (radar sensor)	34540-325/1 9-5
WITTE-Velbert	SDHTAG3NFC (locking system)	I005 20 P1620047900

Singapore

Manufacturer	Model designation	Radio equipment approval number (if available)
		Complies with IMDA Standards
ADC	ARS4-A (radar sensor)	DA103365
ADC	ARS4-B (radar sensor)	DA103365
ADC	ARS4-C (radar sensor)	DA103365
Bosch	FR5CPCCF (radar sensor)	N3368-19
Bosch	LRR3 (radar sensor)	N0380-15

Manufacturer	Model designation	Radio equipment approval number (if available)
Bosch	MRR1Rear (radar sensor)	N0871-19
Bosch	MRRe14FCR (radar sensor)	N1699-17
Continental Antenna	RKE213E1 (antenna amplifier)	N2681-20 DA105282
Continental Antenna	RKE223E1GNS (antenna amplifier)	N4939-19 DA107248
Continental Automotive	CMKG1 (locking system)	N4774-19 DA103365
Continental Automotive	MARS Keyless (locking system)	N1298-17 DA103365

Manufacturer	Model designation	Radio equipment approval number (if available)
Continental Automotive	D-WMI2020A (control unit)	N4961-19 DA103365
HELLA	DM4 (locking system)	N3010-17 DA103365
Hirschmann	920287A (locking system)	N0812-11 DA103365
Hirschmann	920287B (locking system)	N1231-12 DA103365
HUF Bao-long	TSSRE4A (tire pressure monitor sensor)	DA103787
HUF Bao-long	TSSSG4G6 (tire pressure monitor sensor)	DA103787

Manufacturer	Model designation	Radio equipment approval number (if available)
HUF Bao-long	TSSSG4G6b (tire pressure monitor sensor)	DA28467
HUF	HUF14632 (locking system)	N1934-20 DA105282
HUF	HUF4761 (locking system)	N2797-12 DA103365
LEOPOLD KOSTAL	KK1 (locking system)	N2292-15 DA103365
MAR-QUARDT	DC12A (locking system)	N1138-17 DA103787
MAR-QUARDT	DC12B (locking system)	N0793-16 DA103365

Manufacturer	Model designation	Radio equipment approval number (if available)
MAR-QUARDT	DC12K (locking system)	N0726-16 DA103365
MAR-QUARDT	MS2 (locking system)	N1067-17 DA103787
MAR-QUARDT	MS4 (locking system)	G2709-19 N2718-19 N2717-19 DA103787
MAR-QUARDT	MS5 (locking system)	G2147-20 N2151-20 DB107091
MAR-QUARDT	MK1 (locking system)	N2522-15 DA103365

Manufacturer	Model designation	Radio equipment approval number (if available)
MAR-QUARDT	MK2 (locking system)	N2523-15 DA103365
MAR-QUARDT	3350.38 (locking system)	N0506-19 DA103787
MAR-QUARDT	MU1 (locking system)	G2267-19 DA103787
MAR-QUARDT	MU2 (locking system)	G2148-20 DA103365
Meta System	ITS/TPS (interior protection)	N2215-11
Meta System	MUW II (interior protection)	N2216-11

Manufacturer	Model designation	Radio equipment approval number (if available)
Schrader	AG5SP4-D (tire pressure monitor sensor)	DA105282
Veoneer	77GHz MMRV1 (radar sensor)	N2779-15 DA103365
Veoneer	77V12BSM (radar sensor)	DA103365
Veoneer	77V12CRN (radar sensor)	DA103365
WITTE-Velbert	SDHTAG3NFC (locking system)	N1755-20

South Africa

		
Manufacturer	Model designation	Radio equipment approval number (if available)
ADC	ARS4-A (radar sensor)	TA-2014/1637
ADC	ARS4-B (radar sensor)	TA-2014/1783
ADC	ARS4-C (radar sensor)	TA-2019/1595
Bosch	FR5CPCCF (radar sensor)	TA-2019/1200
Bosch	MRR1Rear (radar sensor)	TA-2014/212

		
Manufacturer	Model designation	Radio equipment approval number (if available)
Bosch	MRRre 14FCR (radar sensor)	TA-2017/2013
Bosch	LRR3 (radar sensor)	1965/007009/07
Continental Antenna	RKE213E1 (antenna amplifier)	TA-2015/1438
Continental Antenna	RKE223E1 (antenna amplifier)	TA-2020/043
Continental Automotive	CMKG1 (locking system)	TA-2019/5405

		
Manufacturer	Model designation	Radio equipment approval number (if available)
Continental Automotive	MARS Keyless (locking system)	TA-2016/3500
Gentex	EURO II (convenience system)	TA-2005/614
Gentex	MUAHL 5 (convenience system)	TA-2015/1386
HELLA	DM4 (locking system)	TA-2017/2518

		
Manufacturer	Model designation	Radio equipment approval number (if available)
Hirschmann	920287A (locking system)	TA-2011/374
Hirschmann	920287B (locking system)	TA-2013/1262
Huf Bao-long	TSSRE4A (tire pressure monitor sensor)	TA-2017/1393

		
Manufacturer	Model designation	Radio equipment approval number (if available)
Huf Bao-long	TSSSG4G6 (control unit) (tire pressure monitor sensor)	TA-2017/1391
Huf Bao-long	TSSSG4G6b (tire pressure monitor sensor)	TA-2019/1440
HUF	HUF14632 (locking system)	TA-2015/1077

		
Manufacturer	Model designation	Radio equipment approval number (if available)
HUF	HUF4761 (locking system)	TA-2012/1543
LEOPOLD KOSTAL	KK1 (locking system)	TA-2015/595
Meta System	ITS Master (interior protection)	TA-2011/1636
Meta System	ITS Sensor (interior protection)	TA-2011/1227

		
Manufacturer	Model designation	Radio equipment approval number (if available)
Meta System	MUW II (interior protection)	TA-2019/261
MAR-QUARDT	DC12A (locking system)	TA-2017/312
MAR-QUARDT	DC12B (locking system)	TA-2011/370
MAR-QUARDT	DC12K (locking system)	TA-2012/1542
MAR-QUARDT	MS2 (locking system)	TA-2016/3314

		
Manufacturer	Model designation	Radio equipment approval number (if available)
MAR-QUARDT	MS4 (locking system)	TA-2019/843
MAR-QUARDT	MS5 (locking system)	TA-2020/5765
MAR-QUARDT	MK1 (locking system)	TA-2015/179
MAR-QUARDT	MK2 (locking system)	TA-2015/180
MAR-QUARDT	MU2 (locking system)	TA-2020/5761

		
Manufacturer	Model designation	Radio equipment approval number (if available)
MAR-QUARDT	3350.38 (locking system)	TA-2018/3985
Schrader	AG5SP4-D (tire pressure monitor sensor)	TA-2015/072
Schrader	MFR (tire pressure monitor sensor)	TA-2019/273

		
Manufacturer	Model designation	Radio equipment approval number (if available)
Schrader	GG4T (tire pressure monitor sensor)	TA-2017/3884
Schrader	DG6W2D4 (tire pressure monitor sensor)	TA-2017/2933
Schrader	MC34MA4 (tire pressure monitor sensor)	TA-2011/1370

		
Manufacturer	Model designation	Radio equipment approval number (if available)
Veoneer	77GHz MMRV1 (radar sensor)	TA-2015/2087
Veoneer	77V12BSM (radar sensor)	TA-2019/1380
Veoneer	77V12CRN (radar sensor)	TA-2019/1382
WITTE-Velbert	SDHTAG3NFC (locking system)	TA-2020/055

South Korea

		
Manufacturer	Model designation	Radio equipment approval number (if available)
HUF	HUF14632 (locking system)	MSIP-CRM-HHF-HUF-14632
MARQUARDT	MU1 (locking system)	R-R-MQU-MU1

Thailand

 Manufacturer	Model designation	Radio equipment approval number (if available)
ADC	ARS4-C (radar sensor)	A57013-19
Bosch	FR5CPCCF (radar sensor)	A57008-19
Bosch	LRR3 (radar sensor)	A57006-15
Bosch	MRR1Rear (radar sensor)	A57005-14

 Manufacturer	Model designation	Radio equipment approval number (if available)
Bosch	MRRe14FCR (radar sensor)	A57003-17
Continental Antenna	RKE213E1 (antenna amplifier)	SDoC
Continental Antenna	RKE223E1GNS (antenna amplifier)	SDoC
Continental Automotive	CMKG1 (locking system)	SDoC

 Manufacturer	Model designation	Radio equipment approval number (if available)
Continental Automotive	MARS Keyless (locking system)	SDoC
HELLA	DM4 (locking system)	SDoC
Hirschmann	920287A (locking system)	SDoC
Hirschmann	920287B (locking system)	SDoC



Manufacturer	Model designation	Radio equipment approval number (if available)
HUF	HUF14632 (locking system)	SDoC
HUF	HUF4761 (locking system)	SDoC
LEOPOLD KOSTAL	KK1 (locking system)	SDoC
MARQUARDT	DC12A (locking system)	SDoC



Manufacturer	Model designation	Radio equipment approval number (if available)
MARQUARDT	DC12B (locking system)	SDoC
MARQUARDT	DC12K (locking system)	SDoC
MARQUARDT	MS2 (locking system)	SDoC
MARQUARDT	MS4 (locking system)	SDoC
MARQUARDT	MS5 (locking system)	SDoC A75004-20



Manufacturer	Model designation	Radio equipment approval number (if available)
MARQUARDT	MK1 (locking system)	SDoC
MARQUARDT	MK2 (locking system)	SDoC
MARQUARDT	3350.38 (locking system)	SDoC
MARQUARDT	MU1 (locking system)	A75002-20
MARQUARDT	MU2 (locking system)	A75005-20



Manufacturer	Model designation	Radio equipment approval number (if available)
Meta System	MUW II (interior protection)	RF test report: 149852-2R1TR FEMC EMC test report: 149852-1R1TR FEMC Safety report: 149852TRFSAF
Veoneer	77GHz MMRV1 (radar sensor)	A57008-16



Manufacturer	Model designation	Radio equipment approval number (if available)
Veoneer	77V12BSM (radar sensor)	A57004-19
Veoneer	77V12CRN (radar sensor)	A57004-19
WITTE-Velbert	SDHTAG3N FC (locking system)	SDoC

Togo

Manufacturer	Model designation	Radio equipment approval number (if available)
Continental Antenna	RKE213E1 (antenna amplifier)	No. 024/19
Continental Automotive	MARS Keyless (locking system)	No. 040/19
HELLA	DM4 (locking system)	No. 039/19
Hirschmann	920287A (locking system)	No. 089/19
Hirschmann	920287B (locking system)	No. 088/19

Manufacturer	Model designation	Radio equipment approval number (if available)
HUF	HUF4761 (locking system)	No. 041/19
KATHREIN	RKE213E1 (locking system)	No. 024/19
LEOPOLD KOSTAL	KK1 (locking system)	No. 060/19
MARQUARDT	DC12A (locking system)	No. 055/19
MARQUARDT	DC12B (locking system)	No. 057/19
MARQUARDT	DC12K (locking system)	No. 056/19

Manufacturer	Model designation	Radio equipment approval number (if available)
MARQUARDT	MS2 (locking system)	No. 008/19
MARQUARDT	MS4 (locking system)	No. 101/19
MARQUARDT	MK1 (locking system)	No. 021/19
MARQUARDT	MK2 (locking system)	No. 022/19
MARQUARDT	3350.38 (locking system)	No. 016/20
MARQUARDT	MU1 (locking system)	No. 100/19

Ukraine



Manufacturer	Model designation	Radio equipment approval number (if available)
ADC	ARS4-A (radar sensor)	UA RF: 1CONT0004
ADC	ARS4-B (radar sensor)	UA RF: 1CONT0001
ADC	ARS4-C (radar sensor)	UA.TR. 109.R. 0017-19
Bosch	FR5CPCCF (radar sensor)	UA RF: 1BOSC0009



Manufacturer	Model designation	Radio equipment approval number (if available)
Bosch	LRR3 (radar sensor)	UA.TR. 109.R. 0031-19
Bosch	MRR1Rear (radar sensor)	UA.TR. 109.R. 0598-18
Bosch	MRRre 14FCR (radar sensor)	UA.TR. 109.R. 0030-19
Continental Antenna	RKE213E1 (antenna amplifier)	UKR. 355-123/19



Manufacturer	Model designation	Radio equipment approval number (if available)
Continental Antenna	RKE223E1GNS (antenna amplifier)	UA.R.TR. 052.682-19
Continental Automotive	CMKG1 (locking system)	UA1.001.021 175-20-TE
Continental Automotive	MARS Keyless (locking system)	RTS.UKR. 355-34/18
Gentex	EURO II (convenience system)	UA1.001.00 8806-15



Manufacturer	Model designation	Radio equipment approval number (if available)
HELLA	DM4 (locking system)	UA.TR. 109.R. 0325-18
Hirschmann	920287A (locking system)	UKR. 355-7/20
Hirschmann	920287B (locking system)	UKR. 355-8/20
Huf Baolong	TSSRE4A (tire pressure monitor sensor)	UA 1.001.01856 8-19-TE



Manufacturer	Model designation	Radio equipment approval number (if available)
Huf Baolong	TSSSG4G6 (control unit) (tire pressure monitor sensor)	UA 1.001.01858 6-19-TE
Huf Baolong	TSSSG4G6b (control unit) (tire pressure monitor sensor)	UA 1.001.01928 9-19-TE
HUF	HUF14632 (locking system)	UKR. 355-113/19
HUF	HUF4761 (locking system)	UA 1.001.018 653-19-TE



Manufacturer	Model designation	Radio equipment approval number (if available)
LEOPOLD KOSTAL	KK1 (locking system)	10094.0066 82-19
MAR-QUARDT	DC 12A (locking system)	UA.R.TR. 052.307-19
MAR-QUARDT	DC 12B (locking system)	UA.R.TR. 052.308-19
MAR-QUARDT	DC 12K (locking system)	UA.R.TR. 052.309-19
MAR-QUARDT	MS2 (locking system)	UA 1.001.019 129-19-TE



Manufacturer	Model designation	Radio equipment approval number (if available)
MAR-QUARDT	MS4 (locking system)	UA.R.TR. 052.528-19
MAR-QUARDT	MS5 (locking system)	632.16-CET
MAR-QUARDT	MK1 (locking system)	UA 1.001.019 233-19-TE
MAR-QUARDT	MK2 (locking system)	UA 1.001.019 234-19-TE
MAR-QUARDT	3350.38 (locking system)	UA 1.001.018 888-19-TE



Manufacturer	Model designation	Radio equipment approval number (if available)
Schrader	AG5SP4 (tire pressure monitor sensor)	UA.TR. 028
Veoneer	77V12BSM (radar sensor)	UA RF: 1VEON2BSM
Veoneer	77V12CRN (radar sensor)	UA RF: 1VEON2CRN



Manufacturer	Model designation	Radio equipment approval number (if available)
Veoneer	77GHz MMRV 1 (radar sensor)	TEC/ DoC No VEON-EER.UKR. 355-3/19 NKRZi No- UA RF: 2VEONMRV 1
WITTE-Velbert	SDHTAG3NFC (locking system)	UA.R.TR. 052.120-20

Uzbekistan

Manufacturer	Model designation	Radio equipment approval number (if available)
Continental Automotive	CMKG 1 (locking system)	
HELLA	DM4 (locking system)	UZ.SMT. 01.319.2581135
MARQUARDT	DC 12A (locking system)	
MARQUARDT	DC 12B (locking system)	



Manufacturer	Model designation	Radio equipment approval number (if available)
MARQUARDT	DC 12K (locking system)	
MARQUARDT	MS2 (locking system)	UZ.SMT. 01.319.2550607
MARQUARDT	MS4 (locking system)	UZ.SMT. 01.319.2581337
MARQUARDT	MS5 (locking system)	UZ.SMT. 01.319.2581337





Manufacturer	Model designation	Radio equipment approval number (if available)
MARQUARDT	MK1 (locking system)	
MARQUARDT	MK2 (locking system)	
MARQUARDT	3350.38 (locking system)	
MARQUARDT	MU1 (locking system)	



Manufacturer	Model designation	Radio equipment approval number (if available)
MARQUARDT	MU2 (locking system)	UZ.SMT. 01.344.17623993
WITTE-Velbert	SDHTAG3 NFC (locking system)	UZ.SMT. 01.319.2581054

United Arab Emirates

		
Manufacturer	Model designation	Radio equipment approval number (if available)
ADC	ARS4-A (radar sensor)	TRA ER58296/17, DA40068
ADC	ARS4-B (radar sensor)	TRA ER61136/18, DA40068/15
ADC	ARS4-C (radar sensor)	TRA ER77062/19, DA40068

		
Manufacturer	Model designation	Radio equipment approval number (if available)
Bosch	FR5CPCCF (radar sensor)	TRA ER74533/19, DA36758/14
Continental Antenna	RKE213E1 (antenna amplifier)	TRA ER64693/18, DA36975/14
Continental Antenna	RKE223E1GNS (antenna amplifier)	TRA E76442/19, DA65993/17

		
Manufacturer	Model designation	Radio equipment approval number (if available)
Continental Automotive	CMKG1 (locking system)	TRA ER77964/20, DA0018994/09
Continental Automotive	MARS Keyless (locking system)	TRA ER56005/15, DA44932/15



Manufacturer	Model designation	Radio equipment approval number (if available)
Gentex	MUAHL 5 (convenience system)	TRA ER41849/15, DA35176/14
HELLA	DM4 (locking system)	TRA ER56616/17, DA44932/15
Hirschmann	920287A (locking system)	TRA ER52213/17, DA35219/14



Manufacturer	Model designation	Radio equipment approval number (if available)
Hirschmann	920287B (locking system)	TRA ER42011/5, DA35219/14
Huf Baolong	TSSRE4A (tire pressure monitor sensor)	TRA ER57806/17, DA36976/14
Huf Baolong	TSSSG4G6 (control unit) (tire pressure monitor sensor)	TRA ER57807/17, DA36976/14



Manufacturer	Model designation	Radio equipment approval number (if available)
Huf Baolong	TSSSG4G6b (control unit) (tire pressure monitor sensor)	TRA ER7307/19, DA0086237/12
HUF	HUF14632 (locking system)	TRA ER63716/18, DA36976/14
HUF	HUF4761 (locking system)	TRA ER55496/17, DA36976/14



Manufacturer	Model designation	Radio equipment approval number (if available)
LEOPOLD KOSTAL	KK 1 (locking system)	TRA ER62622/18
MAR-QUARDT	DC 12A (locking system)	TRA ER53465/17 , DA0018994/09
MAR-QUARDT	DC 12B (locking system)	TRA ER0067828/11, DA0018994/09



Manufacturer	Model designation	Radio equipment approval number (if available)
MAR-QUARDT	DC 12K (locking system)	TRA ER0067829/11, DA0018994/09
MAR-QUARDT	MS2 (locking system)	TRA ER52668/17 , DA0018994/09



Manufacturer	Model designation	Radio equipment approval number (if available)
MAR-QUARDT	MS4 (locking system)	TRA ER71616/19, DA0018994/09
MAR-QUARDT	MS5 (locking system)	TRA ER80720/20 , DA0018994/09
MAR-QUARDT	MK 1 (locking system)	TRA ER64145/18, DA0018994/09



Manufacturer	Model designation	Radio equipment approval number (if available)
MAR-QUARDT	MK2 (locking system)	TRA ER64146/18, DA0018994/09
MAR-QUARDT	3350.38 (locking system)	TRA ER69280/19, 0018994/09
MAR-QUARDT	MU1 (locking system)	TRA ER71833/19, DA0018994/09



Manufacturer	Model designation	Radio equipment approval number (if available)
MAR-QUARDT	MU2 (locking system)	TRA ER81329/20, DA0018994/09
Schrader	AG5SP4-D (tire pressure monitor sensor)	TRA ER37156/15, DA0047074/10



Manufacturer	Model designation	Radio equipment approval number (if available)
Schrader	GG4T (tire pressure monitor sensor)	TRA ER57985/17, DA0047074/10
Schrader	DG6W2D4 (tire pressure monitor sensor)	TRA ER960528/18, DA0047074/10



Manufacturer	Model designation	Radio equipment approval number (if available)
Schrader	MC34MA4 (tire pressure monitor sensor)	TRA ER37066/15 , DA0047074/10
Veoneer	77GHz MMRV 1 (radar sensor)	TRA ER39759/15 , DA0020858
Veoneer	77V12BSM (radar sensor)	TRA ER72324/19





Manufacturer	Model designation	Radio equipment approval number (if available)
Veoneer	77V12CRN (radar sensor)	TRA ER72323/19
WITTE-Velbert	SDHTAG3NFC (locking system)	TRA ER79695/20 , DA0018994/09

United States

Manufacturer	Model designation	Radio equipment approval number (if available)
Bosch	FR5CPCCF (radar sensor)	FCC ID: NF3-FR5CPCCF
Veoneer	77V12BSM (radar sensor)	FCC ID: WU877V12BSM

Vietnam

		
Manufacturer	Model designation	Radio equipment approval number (if available)
Bosch	FR5CPCCF (radar sensor)	234/CVT-TT3
Continental Antenna	RKE213E1 (antenna amplifier)	Suntech Viet-Nam Technology Company Limited C0274151118AF 04A2

		
Manufacturer	Model designation	Radio equipment approval number (if available)
Continental Antenna	RKE223E1GNS (antenna amplifier)	Suntech Viet-Nam Technology Company Limited C0007100120AF 04A2
Continental Automotive	CMKG1 (locking system)	Suntech Viet-Nam Technology Company Limited C0001070120AF 04A2

		
Manufacturer	Model designation	Radio equipment approval number (if available)
Continental Automotive	MARS Keyless (locking system)	Mercedes-Benz Vietnam Company Limited B0748240419AF 04A2
HELLA	DM4 (locking system)	Mercedes-Benz Vietnam Company Limited B0625050419A F04A2
Huf Baolong	TSSRE4A (tire pressure monitor sensor)	C0112200717AF 04A2



Manufacturer	Model designation	Radio equipment approval number (if available)
MAR-QUARDT	DC12A (locking system)	Suntech Vietnam Technology Company Limited C0048080319A F04A2
MAR-QUARDT	DC12B (locking system)	Suntech Vietnam Technology Company Limited C0050080319A F04A2





Manufacturer	Model designation	Radio equipment approval number (if available)
MAR-QUARDT	DC12K (locking system)	Suntech Vietnam Technology Company Limited C0049080319A F04A2
MAR-QUARDT	MS2 (locking system)	Suntech Vietnam Technology Company Limited C0035150219AF 04A2



Manufacturer	Model designation	Radio equipment approval number (if available)
MAR-QUARDT	MS4 (locking system)	Suntech Vietnam Technology Company Limited C0231240919AF 04A2
MAR-QUARDT	MS5 (locking system)	Suntech Vietnam Technology Company Limited C0141140520AF 04A2

		
Manufacturer	Model designation	Radio equipment approval number (if available)
MAR-QUARDT	MK1 (locking system)	Suntech Viet-Nam Technology Company Limited C0021180119AF 04A2
MAR-QUARDT	MK2 (locking system)	Suntech Viet-Nam Technology Company Limited C0022180119AF 04A2

		
Manufacturer	Model designation	Radio equipment approval number (if available)
MAR-QUARDT	3350.38 (locking system)	Suntech Viet-Nam Technology Company Limited C0076150319AF 04A2
Schrader	AG5SP4 (tire pressure monitor sensor)	C0002050119AF 042A
Schrader	GG4T (tire pressure monitor sensor)	C0170191017AF 04A2

		
Manufacturer	Model designation	Radio equipment approval number (if available)
Schrader	DG6W2D4 (tire pressure monitor sensor)	C0078070518AF 04A2
Veoneer	77V12BSM (radar sensor)	A47/CVT-TT3



Manufacturer	Model designation	Radio equipment approval number (if available)
Veoneer	77V12CRN (radar sensor)	A48/CVT-TT3
WITTE-Velbert	SDHTAG3N FC (locking system)	Mercedes-Benz Vietnam Company Limited A0847130820A F04A3



Eurasian Economic Union







Manufacturer	Model designation	Radio equipment approval number (if available)
ADC	ARS4-A (radar sensor)	—
ADC	ARS4-B (radar sensor)	—
ADC	ARS4-C (radar sensor)	—
Bosch	FR5CPCCF (radar sensor)	—







Manufacturer	Model designation	Radio equipment approval number (if available)
Bosch	LRR3 (radar sensor)	—
Bosch	MRR1Rear (radar sensor)	—
Bosch	MRRe14FCR (radar sensor)	—
Bosch	FR5CPCCF (radar sensor)	—



		
Manufacturer	Model designation	Radio equipment approval number (if available)
Continental Antenna	RKE213E1 (antenna amplifier)	—
Continental Antenna	RKE223E1GNS (antenna amplifier)	—
Continental Automotive	MARS Keyless (locking system)	—
HELLA	DM4 (locking system)	—

		
Manufacturer	Model designation	Radio equipment approval number (if available)
Hirschmann	920287A (locking system)	—
Hirschmann	920287B (locking system)	—
Huf Baolong	TSSRE4A (tire pressure monitor sensor)	—
Huf Baolong	TSSSG4G6 (tire pressure monitor sensor)	—

		
Manufacturer	Model designation	Radio equipment approval number (if available)
Huf Baolong	TSSSG4G6b (tire pressure monitor sensor)	—
HUF	HUF4761 (locking system)	—
HUF	HUF14632 (locking system)	—
LEOPOLD KOSTAL	KK1 (locking system)	—

		
Manufacturer	Model designation	Radio equipment approval number (if available)
MARQUARDT	DC12A (locking system)	—
MARQUARDT	DC12B (locking system)	—
MARQUARDT	DC12K (locking system)	—
MARQUARDT	MS2 (locking system)	—
MARQUARDT	MS4 (locking system)	—

		
Manufacturer	Model designation	Radio equipment approval number (if available)
MARQUARDT	MS5 (locking system)	—
MARQUARDT	MK1 (locking system)	—
MARQUARDT	MK2 (locking system)	—
MARQUARDT	3350.38 (locking system)	—
MARQUARDT	MU1 (locking system)	—

		
Manufacturer	Model designation	Radio equipment approval number (if available)
Schrader	AG5SP4-D (tire pressure monitor sensor)	—
Veoneer	77GHz MMRV1 (radar sensor)	—
Veoneer	77V12BSM (radar sensor)	—

EAC Manufacturer	EAC Model designation	Radio equipment approval number (if available)
Veoneer	77V12CRN (radar sensor)	–
WITTE-Velbert	SDHTAG3NFC (locking system)	–

Vehicle identification plate, VIN and engine number overview

Vehicle identification plate

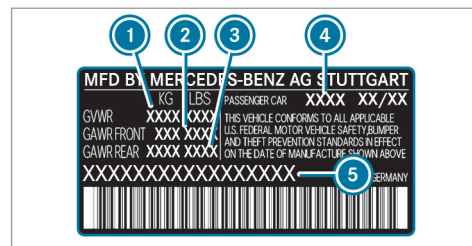
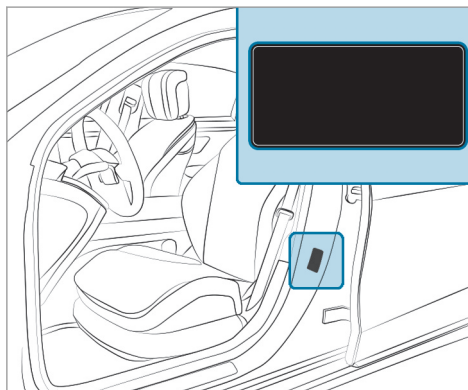

Vehicle identification plate (USA only)

- ① Maximum permissible gross vehicle weight
- ② Maximum permissible front axle load
- ③ Maximum permissible rear axle load
- ④ Paint code
- ⑤ VIN (vehicle identification number)

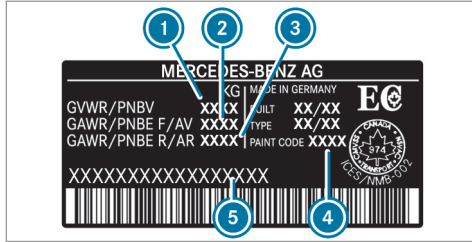

Vehicle identification plate (Canada only)

- ① Maximum permissible gross vehicle weight
- ② Maximum permissible front axle load
- ③ Maximum permissible rear axle load
- ④ Paint code
- ⑤ VIN (vehicle identification number)

The maximum permissible gross vehicle weight is made up of the vehicle weight, all vehicle occupants, the fuel and the load. The maximum gross axle weight rating is the maximum weight that can be carried on one axle (front or rear axle).

Never exceed the maximum permissible gross vehicle weight or the maximum gross axle weight rating for the front or rear axle.

VIN in the engine compartment

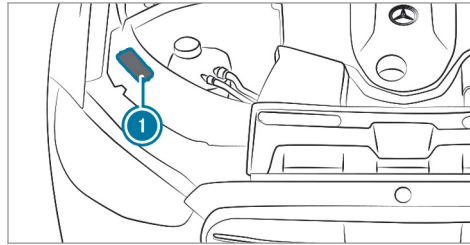

- ① VIN (vehicle identification number)

Additional plates

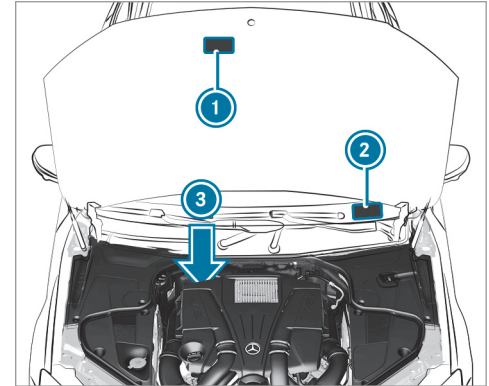

- ① Plate with information about emissions testing, including confirmation of emissions guidelines at the U.S. federal level as well as for California
- ② VIN (vehicle identification number)
- ③ Engine number (stamped into the crankcase)

Operating fluids

Notes on operating fluids

⚠ WARNING Risk of injury from operating fluids harmful to your health

Operating fluids may be poisonous and harmful to your health.

- ▶ Observe the text on the original containers when using, storing or disposing of operating fluids.
- ▶ Always store operating fluids sealed in their original containers.
- ▶ Always keep children away from operating fluids.

🔥 ENVIRONMENTAL NOTE Environmental pollution caused by environmentally irresponsible disposal

- ▶ Dispose of operating fluids in an environmentally responsible manner.

Operating fluids include the following:

- Fuels
- Lubricants
- Coolant
- Brake fluid
- Windshield washer fluid
- Climate control system refrigerant

Only use products approved by Mercedes-Benz. Damage caused by the use of products that have not been approved is not covered by the Mercedes-Benz warranty or goodwill gestures.

The operating fluids approved by Mercedes-Benz can be identified by the following inscriptions on the container:

You can identify operating fluids approved by Mercedes-Benz by the following inscriptions on the container:

- MB-Freigabe (e.g. MB-Freigabe 229.51)
- MB-Approval (e.g. MB-Approval 229.51)

Further information on approved operating fluids:

- In the Mercedes-Benz Specifications for Operating Fluids by entering the designation
 - At <https://bevo.mercedes-benz.com>
 - In the Mercedes-Benz BeVo app
- At a qualified specialist workshop

⚠ WARNING Risk of fire or explosion from fuel

Fuels are highly flammable.

- ▶ Fire, open flames, smoking and creation of sparks must be avoided.
- ▶ Switch off the ignition and, if available, the stationary heater, before and while refueling the vehicle.

⚠ WARNING Risk of injury from fuels

Fuels are poisonous and hazardous to your health.

- ▶ Do not swallow fuel or let it come into contact with skin, eyes or clothing.
- ▶ Do not inhale fuel vapor.
- ▶ Keep children away from fuel.
- ▶ Keep doors and windows closed during the refueling process.

If you or other people come into contact with fuel, observe the following:

- ▶ Immediately rinse fuel off your skin with soap and water.
- ▶ If fuel comes into contact with your eyes, immediately rinse them thoroughly with clean water. Seek medical attention immediately.
- ▶ If you swallow fuel, seek medical attention immediately. Do not induce vomiting.
- ▶ Change immediately out of clothing that has come into contact with fuel.

Fuel

Notes on fuel grades for vehicles with a gasoline engine

Observe the notes on operating fluids (→ page 494).

! NOTE Damage caused by the wrong fuel

Even small amounts of the wrong fuel could result in damage to the fuel system, the engine and the emission control system.

- ▶ Only refuel with low-sulfur gasoline.

This fuel may contain up to 10% ethanol by volume. Your vehicle is suitable for use with E10 fuel.

Never refuel with one of the following fuels:

- Diesel
- Gasoline with more than 10% ethanol by volume, e.g. E15, E85, E100
- Gasoline with more than 3% methanol by volume, e.g. M15, M30, M85, M100
- Gasoline with additives containing metal

If you have accidentally refueled with the wrong fuel:

- ▶ do not switch the ignition on.
- ▶ Consult a qualified specialist workshop.

If the available fuel is not sufficiently low in sulfur, this can produce unpleasant odors.

Only refuel with fuel that has at least the octane number specified in the information label in the fuel filler flap (→ page 208).

If you want maximum engine output: only refuel with premium-grade unleaded gasoline with an octane number of at least 91 AKI/95 RON.

As a temporary measure, if the recommended fuel is not available, you may also use regular unleaded gasoline with an octane number of at least 87 AKI/91 RON.

! **NOTE** Premature wear through unleaded regular gasoline

Unleaded regular gasoline can cause the engine to wear more quickly and impair longevity and performance.

If unleaded premium grade gasoline is unavailable and you have to refuel using unleaded regular gasoline with 87 AKI/91 RON:

- ▶ Only fill the fuel tank to half full with unleaded regular gasoline and top up as soon as possible with unleaded premium grade gasoline.
- ▶ Do not drive at the maximum speed.
- ▶ Avoid sudden acceleration and engine speeds over 3000 rpm.

This may reduce engine output and increase fuel consumption. Never refuel using gasoline with a lower octane number.

Further information on fuel is available at the following locations:

- At a gas station

- At a qualified specialist workshop
- On the <https://www.mbusa.com> (USA only)

Notes on additives in gasoline (vehicles with gasoline engine)

Observe the notes on operating fluids (→ page 494).

! **NOTE** Damage from use of unsuitable additives

Even small amounts of the wrong additive may lead to malfunctions occurring.

- ▶ Only add cleaning additives recommended by Mercedes-Benz to the fuel.

Mercedes-Benz recommends that you use brand-name fuels with additives.

In some countries, the fuel available may not have sufficient additives. Deposits could build up in the fuel injection system as a result. In this case, in consultation with an authorized Mercedes-Benz Center, mix the fuel with the cleaning additive recommended by Mercedes-Benz. Observe the notes and mixing ratios indicated on the tank.

Information on fuel grades for vehicles with a diesel engine

General notes

Observe the notes on operating fluids (→ page 494).

! **WARNING** Risk of fire from fuel mixture

If you mix diesel fuel with gasoline, the flash point of the fuel mixture is lower than that of pure diesel fuel.

- ▶ Never refuel using gasoline in diesel engines.
- ▶ Never mix gasoline with diesel fuel.

! **NOTE** Damage caused by the wrong fuel

Even small amounts of the wrong fuel could result in damage to the fuel system, the engine and the emission control system.

Vehicles with a diesel particulate filter

- ▶ Only refuel using sulfur-free diesel fuel that conforms to European standard EN 590, or an equivalent specification. In countries without sulfur-free diesel fuel, refuel using only low-sulfur diesel fuel with a sulfur content less than 50 ppm.

Vehicle without diesel particulate filter:

- ▶ Refuel using only diesel fuel with a sulfur content less than 500 ppm.
- ▶ Only refuel using sulfur-free diesel fuel.

Never refuel with one of the following fuels:

- Gasoline
- Marine diesel
- Heating oil
- Pure fatty acid methyl ester or vegetable oil
- Paraffin or kerosene

If you have accidentally refueled with the wrong fuel:

- ▶ Do not switch the ignition on.
- ▶ Consult a qualified specialist workshop.

The recommended fuel grade for your vehicle can be found on the information label in the fuel filler flap (→ page 208).

Information on low outside temperatures

Refuel your vehicle with as much winter diesel fuel as possible at the beginning of winter.

Before changing over to winter diesel fuel, the fuel tank should be empty, if possible. Keep the fuel level low for the first refueling with winter diesel fuel, e.g. to reserve level. The fuel tank can be filled as usual when next refueling.

Further information on fuel is available at the following locations:

- At a gas station
- At a qualified specialist workshop
- On the <https://www.mbusa.com> (USA only)

Tank content and reserve fuel

Model	Total capacity
All models	20.1 gal (76.0 liters)
Of which reserve	
All models	2.1 gal (8.0 liters)

Engine oil

Notes on engine oil

Observe the notes on operating fluids (→ page 494).



! **NOTE** Engine damage caused by an incorrect oil filter, incorrect oil or additives

- ▶ Do not use engine oils or oil filters other than those which meet the specifications necessary for the prescribed service intervals.
- ▶ Do not alter the engine oil or oil filter in order to achieve longer change intervals than prescribed.
- ▶ Do not use additives.
- ▶ Have the engine oil changed after the prescribed intervals.

Mercedes-Benz recommends that you have the oil change carried out at a qualified specialist workshop.

Quality and capacity of engine oil

MB-Freigabe or MB-Approval

Model	Engine oil specifications
S 580 4MATIC	229.52 229.61*

* Recommended for lowest possible fuel consumption (lowest SAE viscosity class in each case; observe possible restrictions of the approved SAE viscosity classes).

To achieve the lowest possible fuel consumption, it is recommended to use the engine oil specifications marked in the table for the lowest SAE viscosity class. Possible restrictions of the approved SAE viscosity classes must be observed.

The following values refer to an oil change, including the oil filter.

Missing values were not available at time of going to print.

Model	Capacity
S580 4MATIC	9.0 US qt (8.5 liters)

Notes on brake fluid

Observe the notes on operating fluids (→ page 494).

! **WARNING** Risk of an accident due to vapor pockets forming in the brake system

The brake fluid constantly absorbs moisture from the air. This lowers the boiling point of the brake fluid. If the boiling point is too low, vapor pockets may form in the brake system when the brakes are applied hard.

This causes the braking effect to be impaired.

- ▶ Have the brake fluid renewed at the specified intervals.

Have the brake fluid regularly replaced at a qualified specialist workshop.

Only use a brake fluid approved by Mercedes-Benz according to MB-Freigabe or MB-Approval 331.0.

Coolant

Notes on coolant

Observe the notes on operating fluids (→ page 494).

⚠ WARNING - Risk of fire and injury from antifreeze

If antifreeze comes into contact with hot component parts in the engine compartment, it may ignite.

- ▶ Allow the engine to cool down before adding antifreeze.
- ▶ Make sure that no antifreeze spills out next to the filler opening.
- ▶ Thoroughly clean off any antifreeze from component parts before starting the vehicle.

! NOTE Damage caused by incorrect coolant

- ▶ Only use coolant that has been pre-mixed with the required antifreeze protection.

Information on coolant is available at the following locations:

- In the Mercedes-Benz Specifications for Operating Fluids 310.1
 - At <https://bevo.mercedes-benz.com>
 - In the Mercedes-Benz BeVo app
- At a qualified specialist workshop

! NOTE Overheating at high outside temperatures

If an inappropriate coolant is used, the engine cooling system is not sufficiently protected against overheating and corrosion at high outside temperatures.

- ▶ Always use coolant approved by Mercedes-Benz.

- ▶ Observe the instructions in the Mercedes-Benz Specifications for Operating Fluids 310.1.

Have the coolant regularly replaced at a qualified specialist workshop.

Proportion of antifreeze concentrate in the engine cooling system:

- A minimum of 50% (antifreeze protection down to approximately -35°F (-37°C))
- A maximum of 55% (antifreeze protection down to -49°F (-45°C))

Coolant capacity

Model	Capacity
S 500 4MATIC	18.0 US qt (17.0 liters)
S 580 4MATIC	16.1 US qt (15.2 liters)

Notes on windshield washer fluid

Observe the notes on operating fluids (→ page 494).

⚠ WARNING - Risk of fire and injury from windshield washer concentrate

Windshield washer concentrate is highly flammable. It could ignite if it comes into contact with hot engine component parts or the exhaust system.

- ▶ Make sure that no windshield washer concentrate spills out next to the filler opening.

! NOTE Damage to the exterior lighting due to unsuitable windshield washer fluid

Unsuitable windshield washer fluid may damage the plastic surface of the exterior lighting.

- ▶ Only use windshield washer fluid which is also suitable for use on plastic surfaces, e.g. MB SummerFit or MB WinterFit.

! NOTE Blocked spray nozzles caused by mixing windshield washer fluids

- ▶ Do not mix MB SummerFit and MB WinterFit with other windshield washer fluids.

Do not use distilled or de-ionized water. Otherwise, the fill level sensor may be triggered erroneously.

Recommended windshield washer fluid:

- Above freezing point: e.g. MB SummerFit
- Below freezing point: e.g. MB WinterFit

For the correct mixing ratio, refer to the information on the antifreeze container.

Mix washer fluid with windshield washer fluid all year round.

Refrigerant

Notes on refrigerant

Observe the notes on operating fluids (→ page 494).

! NOTE Damage due to incorrect refrigerant

If a non-approved refrigerant is used, the climate control system may be damaged.

- ▶ **USA:** use only R-134a refrigerant.
- ▶ **Canada:** use only R-1234yf refrigerant.

! NOTE Damage to the climate control system due to incorrect refrigerant compressor oil

- ▶ Only use refrigerant compressor oil that has been approved by Mercedes-Benz.
- ▶ Do not mix the approved refrigerant compressor oil with a different refrigerant compressor oil.

Work on the climate control system may be carried out only by a qualified specialist workshop. All applicable regulations, as well as SAE standard J639, must be adhered to.

The information label for the climate control system regarding the refrigerant type and the refrigerant

erant compressor oil (PAG oil) is located on the inside of the hood.

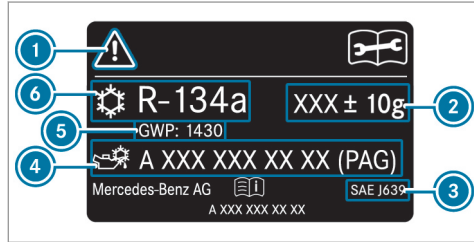

Information label (example – USA/China)

- ① Hazard and service warning symbols
- ② Refrigerant filling capacity
- ③ Applicable standards
- ④ PAG oil part number
- ⑤ GWP (global warming potential) of the refrigerant used
- ⑥ Refrigerant type

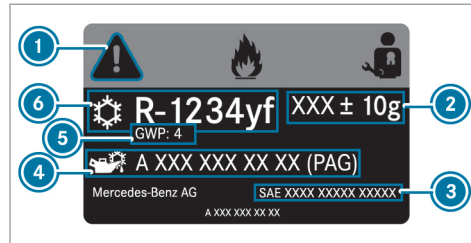

Information label (example – Canada)

- ① Hazard and service warning symbols
- ② Refrigerant filling capacity
- ③ Applicable standards
- ④ PAG oil part number
- ⑤ GWP (global warming potential) of the refrigerant used
- ⑥ Refrigerant type

Symbols ① indicate the following:

- Possible dangers
- Having maintenance work carried out at a qualified specialist workshop

Filling capacity for refrigerant and PAG oil

Model	Refrigerant
S 500 4MATIC	24.7 ± 0.4 oz (700 ± 10 g)
Canada: S 580 4MATIC	23.6 ± 0.4 oz (670 ± 10 g)
USA: S 580 4MATIC	24.7 ± 0.4 oz (700 ± 10 g)
Model	PAG oil
S 500 4MATIC	4.9 ± 0.4 oz (140 ± 10 g)
S 580 4MATIC	

Vehicle data

Vehicle dimensions

The heights specified may vary as a result of the following factors:

- Tires
- Load

502 Technical data

- Condition of the suspension
- Optional equipment

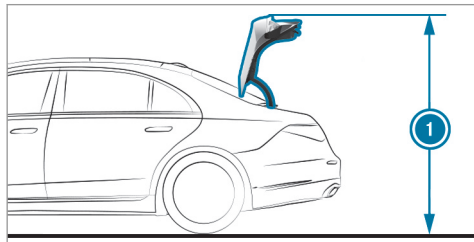

Missing values were not available at the time of going to press.

Height when opened

Model	1 Height when opened
All models	73.0 in (1855 mm)

Vehicle dimensions

S 580 4MATIC

Vehicle length	208.2 in (5289 mm)
Vehicle width including outside mirrors	83.0 in (2109 mm)
Vehicle height	59.2 in (1503 mm)
Wheelbase	126.6 in (3216 mm)
Turning radius	42.0 ft (12.8 m)

Weights and loads

Please note the following for the specified vehicle data:

- Items of optional equipment increase the curb weight and reduce the payload.

Model	Maximum roof load
All models	221 lb (100 kg)

Display messages

Introduction



Notes about display messages



Display messages appear on the driver display.

Display messages with graphical symbols are simplified in the Operator's Manual and may differ from the symbols on the driver display. The driver display shows high-priority display messages in red. Certain display messages are accompanied by a warning tone.

Please act in accordance with the display messages and follow the additional notes in the Operator's Manual.

For some display messages, a symbol will also be shown:

-  Further information
-  Hide display message

With the left-hand Touch Control, you can select the respective symbol by swiping to the left or right. Press the  symbol to show further information on the central display. Press the  symbol to hide the display message.

You can hide low-priority display messages by pressing the  back button or the left-hand Touch Control. The display messages will then be stored in the message memory.

Rectify the cause of a display message as quickly as possible.

High-priority display messages cannot be hidden. The driver display shows these display messages continuously until the cause of the display message has been rectified.

Calling up saved display messages

Driver display:



 [Service](#)  [Message Memory: XX](#)

If there are no display messages, [No Messages](#) will appear on the driver display.

 Scroll through the display messages by swiping upwards or downwards on the left-hand Touch Control.

 **To exit the message memory:** press the back button .

Occupant safety

Display messages	Possible causes/consequences and ► Solutions
 <p>Restraint System Malfunction Service Required</p>	<p>* The restraint system is malfunctioning (→ page 43).</p> <p>▲ WARNING Risk of injury due to malfunctions in the restraint system</p> <p>Components in the restraint system may be activated unintentionally or not deploy as planned in an accident.</p> <p>► Have the restraint system checked and repaired immediately at a qualified specialist workshop.</p>
 <p>Front Left Malfunction Service Required (example)</p>	<p>* The corresponding restraint system is malfunctioning (→ page 43).</p> <p>▲ WARNING Risk of injury due to malfunctions in the restraint system</p> <p>Components in the restraint system may be activated unintentionally or not deploy as planned in an accident.</p> <p>► Have the restraint system checked and repaired immediately at a qualified specialist workshop.</p>
 <p>Left Window Airbag Malfunction Service Required (example)</p>	<p>* The corresponding restraint system is malfunctioning (→ page 43).</p> <p>▲ WARNING Risk of injury or fatal injury due to a malfunction in the window curtain airbag</p> <p>The window curtain airbag might be triggered unintentionally or might not be triggered at all in the event of an accident.</p> <p>► Have the window curtain airbag checked and repaired immediately at a qualified specialist workshop.</p>

Display messages	Possible causes/consequences and ► Solutions
<p>Push rear-left seat belt extender back manually. See Operator's Manual (example)</p>	<ul style="list-style-type: none"> * The corresponding seat belt extender is malfunctioning. <ul style="list-style-type: none"> ► Slide the seat belt extender back into its original position manually. ► If the malfunction occurs again, consult a qualified specialist workshop.
<p>Front Passenger Airbag Disabled See Operator's Manual</p>	<ul style="list-style-type: none"> * The front passenger airbag has been disabled even though an adult or a person of adult stature is on the front passenger seat. If additional forces are applied to the seat, the weight the system detects may be too low. <div style="border: 1px solid black; padding: 5px; margin: 5px 0;"> <p>▲ WARNING Risk of injury or fatal injury due to a disabled front passenger airbag</p> <p>If the front passenger airbag is disabled, the front passenger airbag will not be deployed in the event of an accident and cannot perform its intended protective function.</p> <p>A person in the front passenger seat could then, for example, come into contact with the vehicle's interior, especially if the person is sitting too close to the cockpit.</p> <ul style="list-style-type: none"> ► Make sure, both before and during the journey, that the status of the front passenger airbag is correct. </div> <ul style="list-style-type: none"> ► Stop the vehicle immediately in accordance with the traffic conditions. ► Make sure that no objects are trapped under the front passenger seat. ► Check the status of automatic front passenger airbag actuation (→ page 55). ► If necessary, consult a qualified specialist workshop immediately.

Display messages	Possible causes/consequences and ► Solutions
<p>Front Passenger Airbag Enabled See Operator's Manual</p>	<p>* The front passenger airbag will be enabled while the vehicle is in motion in the following situations:</p> <ul style="list-style-type: none">• Even when a child, a small adult or an object weighing less than the system weight threshold is located on the front passenger seat• Even when the front passenger seat is not occupied <p>The system may detect objects or forces that are adding to the weight applied to the seat.</p> <p>▲ WARNING Risk of injury or death when using a child restraint system while the front passenger airbag is enabled</p> <p>If you secure a child in a child restraint system on the front passenger seat and the front passenger airbag is enabled, the front passenger airbag can deploy in the event of an accident.</p> <p>The child could be struck by the airbag.</p> <p>► Ensure, both before and during the journey, that the status of the front passenger airbag is correct.</p> <p>NEVER use a rearward facing child restraint on a seat protected by an ACTIVE AIRBAG in front of it, DEATH or SERIOUS INJURY to the CHILD can occur.</p> <ul style="list-style-type: none">► Stop the vehicle immediately in accordance with the traffic conditions.► Make sure that no objects are trapped under the front passenger seat.► Check the status of automatic front passenger airbag actuation (→ page 55).► If necessary, consult a qualified specialist workshop immediately.

Display messages	Possible causes/consequences and ► Solutions
PRE-SAFE Inoperative See Operator's Manual	* The PRE-SAFE® functions are malfunctioning. ► Consult a qualified specialist workshop.
PRE-SAFE Impulse Side Inoperative See Operator's Manual	* The PRE-SAFE® Impulse Side system is malfunctioning or inoperative after having already been triggered. ► Consult a qualified specialist workshop.

SmartKey

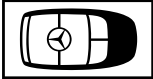
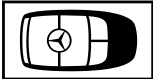

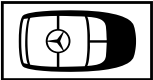
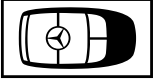
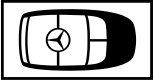

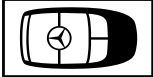
Display messages	Possible causes/consequences and ► Solutions
 Obtain a New Key	* Have SmartKey replaced. ► Consult a qualified specialist workshop.
 Replace Key Battery	* The SmartKey battery is discharged. ► Replace the battery (→ page 78).

Display messages	Possible causes/consequences and ► Solutions
 <p>Key Not Detected (white display message)</p>	<p>* The SmartKey is currently undetected.</p> <ul style="list-style-type: none"> ► Change the location of the SmartKey in the vehicle. ► If the SmartKey is still not recognized, place it in the marked space for starting with the SmartKey (→ page 190).
 <p>Key Not Detected (red display message)</p>	<p>* The SmartKey cannot be detected and may no longer be in the vehicle. The SmartKey is no longer in the vehicle and you switch off the engine:</p> <ul style="list-style-type: none"> • You can no longer start the engine. • You cannot centrally lock the vehicle. <p>► Ensure that the SmartKey is in the vehicle.</p> <p>If the SmartKey detection function has a malfunction due to a strong radio signal source:</p> <ul style="list-style-type: none"> ► Stop the vehicle immediately in accordance with the traffic conditions. ► Place the SmartKey in the marked space for starting the engine with the SmartKey (→ page 190).
 <p>Don't Forget Your Key</p>	<p>* A warning tone will also sound. This message reminds you to take your SmartKey with you when you leave the vehicle.</p>

Display messages	Possible causes/consequences and ► Solutions
 <p data-bbox="195 342 469 391">Key Being Initialized Please Wait</p>	<ul style="list-style-type: none"> * The vehicle is processing in order to teach in the new SmartKey. <ul style="list-style-type: none"> ► Wait until processing is complete.
<p data-bbox="195 418 462 495">Place the Key in the Marked Space See Operator's Manual</p>	<ul style="list-style-type: none"> * SmartKey detection is malfunctioning. <ul style="list-style-type: none"> ► Change the location of the SmartKey in the vehicle. ► Place the SmartKey in the marked space for starting the engine with the SmartKey (→ page 190).

Lights

Display messages	Possible causes/consequences and ► Solutions
 <p data-bbox="195 744 358 793">Check Left Low Beam (example)</p>	<ul style="list-style-type: none"> * The corresponding light source is defective. <ul style="list-style-type: none"> ► Drive on carefully. ► Visit a qualified specialist workshop immediately. ⓘ LED light sources: the display message for the corresponding light appears only when all the light-emitting diodes in the light are faulty.

Display messages	Possible causes/consequences and ► Solutions
 <p data-bbox="144 342 384 391">Malfunction See Operator's Manual</p>	<ul style="list-style-type: none"> <li data-bbox="469 249 875 270">* The exterior lighting is malfunctioning. <li data-bbox="495 280 925 301">► Consult a qualified specialist workshop.
 <p data-bbox="144 513 421 562">Automatic Headlamp Mode Inoperative</p>	<ul style="list-style-type: none"> <li data-bbox="469 420 1110 441">* The light sensor for automatic driving lights is malfunctioning. <li data-bbox="495 451 925 472">► Consult a qualified specialist workshop.
 <p data-bbox="144 684 421 733">Active Headlamps Inoperative</p>	<ul style="list-style-type: none"> <li data-bbox="469 591 907 612">* The active headlamps are malfunctioning. <li data-bbox="495 622 925 643">► Consult a qualified specialist workshop.
 <p data-bbox="144 855 371 876">Switch On Headlamps</p>	<ul style="list-style-type: none"> <li data-bbox="469 762 949 783">* You are driving without low-beam headlamps. <li data-bbox="495 793 1031 814">► Turn the light switch to the  or AUTO position.

Display messages	Possible causes/consequences and ► Solutions
 <p data-bbox="195 342 371 366">Switch Off Lights</p>	<ul style="list-style-type: none"> * You are leaving the vehicle and the lights are still switched on. <ul style="list-style-type: none"> ► Turn the light switch to the AUTO position.
<p data-bbox="195 391 450 439">DIGITAL LIGHT Functions Limited</p>	<ul style="list-style-type: none"> * The DIGITAL LIGHT system is malfunctioning. The lighting system will continue to work even without the functions of the DIGITAL LIGHT system. <ul style="list-style-type: none"> ► Consult a qualified specialist workshop.
<p data-bbox="195 495 473 542">MULTIBEAM LED Functions Limited</p>	<ul style="list-style-type: none"> * The MULTIBEAM LED system is malfunctioning. The lighting system will continue to work, but without the functions of the MULTIBEAM LED system. <ul style="list-style-type: none"> ► Consult a qualified specialist workshop.
<p data-bbox="195 598 462 671">Adaptive Highbeam Assist Currently Unavailable See Operator's Manual</p>	<ul style="list-style-type: none"> * Adaptive Highbeam Assist is temporarily unavailable. The system limits have been reached (→ page 161). Once the cause of the problem is no longer present, the system will be available again. The Adaptive Highbeam Assist Now Available display message will appear. <ul style="list-style-type: none"> ► Drive on. ► Operate the high beam manually until Adaptive High Beam Assist is available again.
<p data-bbox="195 806 462 853">Adaptive Highbeam Assist Inoperative</p>	<ul style="list-style-type: none"> * Adaptive Highbeam Assist is malfunctioning. <ul style="list-style-type: none"> ► Drive on.

512 Display messages and warning/indicator lamps

Display messages	Possible causes/consequences and ► Solutions
	<p>or</p> <ul style="list-style-type: none">► Stop the vehicle in accordance with the traffic conditions and restart the vehicle.► If the display message does not disappear: consult a qualified specialist workshop.► Until then, operate the high beam manually.
<p>Adaptive Highbeam Assist Plus Currently Unavailable See Operator's Manual</p>	<p>* Adaptive Highbeam Assist Plus is temporarily unavailable. The system limits have been reached (→ page 163). Once the cause of the problem is no longer present, the system will be available again. The Adaptive Highbeam Assist Plus Available Again display message will appear.</p> <ul style="list-style-type: none">► Drive on.► Operate the high beam manually until Adaptive High Beam Assist Plus is available again.
<p>Adaptive Highbeam Assist Plus Inoperative</p>	<p>* Adaptive Highbeam Assist Plus is malfunctioning.</p> <ul style="list-style-type: none">► Drive on. <p>or</p> <ul style="list-style-type: none">► Stop the vehicle in accordance with the traffic conditions and restart the vehicle.► If the display message does not disappear: consult a qualified specialist workshop.► Until then, operate the high beam manually.
<p>Hazard Warning Light Malfunction</p>	<p>* The hazard warning lamp switch is malfunctioning.</p> <ul style="list-style-type: none">► Consult a qualified specialist workshop.

Vehicle

Display messages

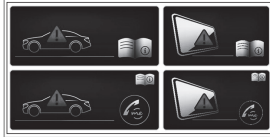

Possible causes/consequences and ► Solutions

- * The driver display is inoperative due to a failed software update.
The display message is shown every time the engine is started.

▲ WARNING Risk of accident due to a driver display malfunction

If the driver display has failed or malfunctioned, the function restrictions applying to safety relevant systems are not visible.

The operating safety of your vehicle may be impaired.



- Drive on carefully.
- Have the vehicle checked immediately at a qualified specialist workshop.

If the operating safety of your vehicle is impaired, park the vehicle immediately and safely. Contact a qualified specialist workshop.



If the driver display fails, you may not recognize function restrictions affecting systems relevant to safety or the speed display, for example. The operating safety of the vehicle may be impaired (→ page 303).



- Have the vehicle checked by a qualified specialist workshop immediately.

Display messages	Possible causes/consequences and ► Solutions
 <p data-bbox="144 342 373 418">Vehicle Ready to Drive Switch the Ignition Off Before Exiting</p>	<p data-bbox="476 249 1009 272">* You are leaving the vehicle in a ready-to-drive state.</p> <ul style="list-style-type: none"> <li data-bbox="495 283 1628 335">► When you leave the vehicle, switch off the ignition, secure the vehicle against rolling away and take the Smart-Key with you. <li data-bbox="495 346 1618 418">► If you do not leave the vehicle, switch off the electrical consumers, e.g. the seat heating. Otherwise, the 12-V battery may discharge and starting the engine may be possible only with the help of a second battery (jump start).
<p data-bbox="144 443 421 519">Head-up Display Currently Unavailable See Operator's Manual</p>	<p data-bbox="476 443 1138 466">* The Head-up Display is temporarily unavailable. Possible causes:</p> <ul style="list-style-type: none"> <li data-bbox="500 477 861 500">• Malfunctions in the power supply <li data-bbox="500 511 722 534">• Signal interference <ul style="list-style-type: none"> <li data-bbox="495 553 1507 576">► Stop the vehicle in accordance with the traffic conditions and switch the ignition off and on again. <li data-bbox="495 587 1286 610">► If the display message still appears, consult a qualified specialist workshop.
<p data-bbox="144 629 402 679">Head-up Display Inopera- tive</p>	<p data-bbox="476 629 916 652">* The Head-up Display has an internal error.</p> <ul style="list-style-type: none"> <li data-bbox="495 664 925 686">► Consult a qualified specialist workshop.
<p data-bbox="144 705 389 781">Head-up Display Bright- ness Currently Reduced See Operator's Manual</p>	<p data-bbox="476 705 1166 728">* The brightness of the Head-up Display is reduced. Possible causes:</p> <ul style="list-style-type: none"> <li data-bbox="500 739 1049 762">• Dirt on the windshield in the camera's field of vision <li data-bbox="500 773 861 796">• Faulty exterior brightness signals <ul style="list-style-type: none"> <li data-bbox="495 815 861 838">► Switch on the windshield wipers. <li data-bbox="495 849 870 872">► Clean the windshield if necessary.



Display messages	Possible causes/consequences and ► Solutions
	<ul style="list-style-type: none"> ► Switch the ignition off and switch it back on. ► If the display message still appears, consult a qualified specialist workshop.
 <p data-bbox="195 418 463 470">Steering Malfunction Drive Carefully Service Required</p>	<p data-bbox="524 325 1513 350">* A power steering malfunction has occurred. Steering characteristics may be impaired as a result.</p> <ul style="list-style-type: none"> ► Drive on carefully. ► Consult a qualified specialist workshop.
 <p data-bbox="195 584 445 660">Steering Malfunction Increased Physical Effort See Operator's Manual</p>	<p data-bbox="524 491 1033 515">* The power steering assistance is malfunctioning.</p> <div data-bbox="547 534 1698 684" style="border: 1px solid gray; padding: 5px;"> <p data-bbox="556 542 1299 567">▲ WARNING Risk of an accident due to altered steering characteristics</p> <p data-bbox="561 584 1633 609">If the power assistance of the steering fails partially or completely, you will need to use more force to steer.</p> <ul style="list-style-type: none"> ► If safe steering is possible, drive on carefully. ► Visit or consult a qualified specialist workshop immediately. </div>
 <p data-bbox="195 791 460 868">Steering Malfunction Stop Immediately See Operator's Manual</p>	<p data-bbox="524 698 1291 723">* The steering is malfunctioning. Steering capability is significantly impaired.</p> <div data-bbox="547 741 1698 829" style="border: 1px solid gray; padding: 5px;"> <p data-bbox="556 750 1206 774">▲ WARNING Risk of accident if steering capability is impaired</p> <p data-bbox="561 791 1461 816">If the steering does not function as intended, the vehicle's operating safety is jeopardized.</p> </div>

516 Display messages and warning/indicator lamps

Display messages	Possible causes/consequences and ► Solutions
	<ul style="list-style-type: none">▶ Pull over and stop the vehicle safely as soon as possible, paying attention to road and traffic conditions. Do not continue driving under any circumstances.▶ Consult a qualified specialist workshop.
 <p>Rear Axle Steering Currently Malfunctioning</p>	<p>* The rear axle steering is temporarily unavailable. The turning radius may increase.</p> <ul style="list-style-type: none">▶ Stop the vehicle in accordance with the traffic conditions and restart the vehicle. <p>If the display message does not disappear:</p> <ul style="list-style-type: none">▶ Drive on carefully.▶ Consult a qualified specialist workshop.
 <p>Rear Axle Steering Malfunction Service Required</p>	<p>* The rear axle steering is malfunctioning.</p> <p>The rear axle has no steering capability.</p> <p>The steering wheel may be tilted when you drive in a straight line.</p> <ul style="list-style-type: none">▶ Adapt your speed and drive on carefully.▶ Consult a qualified specialist workshop immediately.

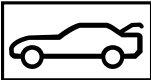

Display messages	Possible causes/consequences and ► Solutions
 <p data-bbox="195 344 482 394">Rear Axle Steering Malfunction Stop Immediately</p>	<p data-bbox="524 249 1665 401">* The rear axle steering is malfunctioning. The rear axle has no steering capability. The steering wheel may tilt considerably when you drive in a straight line. Depending on the steering wheel's tilting position, the steering wheel will also vibrate and a continuous warning tone will sound.</p> <div data-bbox="550 422 1698 601" style="border: 1px solid black; padding: 5px;"> <p data-bbox="559 430 1203 456">▲ WARNING Risk of accident if steering capability is impaired</p> <p data-bbox="559 470 1461 496">If the steering does not function as intended, the vehicle's operating safety is jeopardized.</p> <ul style="list-style-type: none"> <li data-bbox="559 505 1633 557">► Pull over and stop the vehicle safely as soon as possible, paying attention to road and traffic conditions. Do not continue driving under any circumstances. <li data-bbox="559 566 994 592">► Consult a qualified specialist workshop. </div> <p data-bbox="543 619 1142 645">► When stopping, bear the enlarged vehicle width in mind.</p>
<p data-bbox="195 660 445 710">Snow Chain Mode Maximum Speed Exceeded</p>	<p data-bbox="524 660 1295 686">* The maximum permissible speed for snow chain mode has been exceeded.</p> <p data-bbox="543 695 765 721">► Drive more slowly.</p>
	<p data-bbox="524 733 802 759">* At least one door is open.</p> <p data-bbox="543 767 735 793">► Close all doors.</p>

Display messages	Possible causes/consequences and ► Solutions
	<p>* The hood is open.</p> <p>▲ WARNING Risk of accident due to driving with the hood unlocked</p> <p>The hood may open and block your view.</p> <ul style="list-style-type: none"> ▶ Never release the hood when driving. ▶ Before every trip, ensure that the hood is locked. <p>► Stop the vehicle immediately in accordance with the traffic conditions.</p> <p>► Close the hood.</p>
	<p>* The trunk lid is open.</p> <p>▲ DANGER Risk of exhaust gas poisoning</p> <p>Combustion engines emit poisonous exhaust gases such as carbon monoxide. Exhaust gases can enter the vehicle interior if the trunk lid is open when the engine is running, especially if the vehicle is in motion.</p> <ul style="list-style-type: none"> ▶ Always switch off the engine before opening the trunk lid. ▶ Never drive with the trunk lid open. <p>► Close the trunk lid.</p>
<p>Ambient Lighting Warning Support Inoperative</p>	<p>* The ambient lighting may not provide full visual warning support.</p> <p>► Lock the vehicle and unlock it again after a few minutes.</p>



Display messages	Possible causes/consequences and ► Solutions
 <p data-bbox="195 384 399 407">Check Washer Fluid</p>	<p data-bbox="543 249 1387 275">► If the display message appears regularly, contact a qualified specialist workshop.</p> <p data-bbox="519 291 1387 317">* The washer fluid level in the washer fluid reservoir has dropped below the minimum.</p> <p data-bbox="543 327 903 353">► Add washer fluid (→ page 342).</p>
 <p data-bbox="195 526 458 576">Intensive Cleaning Activated for 30 Seconds</p>	<p data-bbox="519 433 1249 458">* Intensive cleaning of the windshield has been activated (→ page 168).</p>
<p data-bbox="195 598 463 648">Windshield Wiper Malfunction</p>	<p data-bbox="519 598 966 624">* The windshield wipers are malfunctioning.</p> <p data-bbox="543 635 774 660">► Restart the engine.</p> <p data-bbox="543 681 903 707">If the display message still appears:</p> <p data-bbox="543 717 977 743">► Consult a qualified specialist workshop.</p>

Engine

Display messages	Possible causes/consequences and ► Solutions
<p>To switch vehicle off, press and hold Start/Stop button for at least 3 seconds or press 3 times</p>	<ul style="list-style-type: none"> * You have pressed the start/stop button while the vehicle is in motion. <ul style="list-style-type: none"> ► Information about switching off the engine while driving (→ page 190).
<p>Cannot Start Vehicle See Operator's Manual</p>	<ul style="list-style-type: none"> * The vehicle cannot be started. <ul style="list-style-type: none"> ► Switch the ignition off and switch it back on. ► If the display message still appears, consult a qualified specialist workshop.
<div style="text-align: center;">  </div> <p>Check Coolant Level See Operator's Manual</p>	<ul style="list-style-type: none"> * The coolant level is too low. <div style="border: 1px solid black; padding: 5px; margin: 10px 0;"> <p>! NOTE Engine damage due to insufficient coolant</p> <ul style="list-style-type: none"> ► Avoid long journeys with insufficient coolant. </div> <ul style="list-style-type: none"> ► Add coolant (→ page 342). ► Have the engine cooling system checked at a qualified specialist workshop.

Display messages	Possible causes/consequences and ► Solutions
 <p data-bbox="195 342 439 391">Coolant Stop Switch Off Vehicle</p>	<p data-bbox="524 249 768 270">* The coolant is too hot.</p> <ul style="list-style-type: none"> <li data-bbox="543 283 1544 308">► Stop the vehicle immediately in accordance with the traffic conditions and switch off the engine. <div data-bbox="543 335 1700 588" style="border: 1px solid gray; padding: 5px;"> <p data-bbox="556 342 1092 367">▲ WARNING Risk of burns when opening the hood</p> <p data-bbox="561 384 1648 433">If you open the hood when the engine has overheated or when there is a fire in the engine compartment, the following situations may occur:</p> <ul style="list-style-type: none"> <li data-bbox="569 446 1040 467">• You could come into contact with hot gases. <li data-bbox="569 480 1295 501">• You could come into contact with other hot, escaping operating fluids. <ul style="list-style-type: none"> <li data-bbox="561 522 1276 542">► Before opening the hood, allow the overheated engine to cool down. <li data-bbox="561 556 1548 577">► In the event of a fire in the engine compartment, keep the hood closed and call the fire service. </div> <ul style="list-style-type: none"> <li data-bbox="543 609 968 629">► Wait until the engine has cooled down. <li data-bbox="543 643 1203 664">► Make sure that the air supply to the radiator is not obstructed. <li data-bbox="543 677 1670 726">► Avoiding high loads on the engine, drive to the nearest qualified specialist workshop. In doing so, ensure that the coolant temperature display remains below the red marking.
	<p data-bbox="524 744 1064 765">* There is a malfunction in the engine cooling system.</p> <ul style="list-style-type: none"> <li data-bbox="543 779 1670 827">► Avoiding high loads on the engine, drive to the nearest qualified specialist workshop. In doing so, ensure that the coolant temperature display remains below the red marking.

522 Display messages and warning/indicator lamps

Display messages	Possible causes/consequences and ► Solutions
 Fuel Level Low	<ul style="list-style-type: none">* The fuel supply has dropped into the reserve range.<ul style="list-style-type: none">► Refuel.
 Fuel Filler Cap Open	<ul style="list-style-type: none">* The fuel filler cap is not closed correctly or the fuel system is leaking.<ul style="list-style-type: none">► Close the fuel filler cap.► If the fuel filler cap was already properly closed: consult a qualified specialist workshop.

Transmission

Display messages	Possible causes/consequences and ► Solutions
Shift to P Only When Vehicle Is Stationary	<ul style="list-style-type: none">* It is possible to select the park position P only if the vehicle is stationary.<ul style="list-style-type: none">► Depress the brake pedal to stop.► Shift the transmission to park position P when the vehicle is stationary.
Depress Brake to Shift from P	<ul style="list-style-type: none">* You have attempted to shift the transmission out of park position P and into another transmission position.<ul style="list-style-type: none">► Depress the brake pedal.► Select transmission position D, R or neutral N.

Display messages	Possible causes/consequences and ► Solutions
To Deselect P or N Depress Brake and Start Vehicle	<p>* You have attempted to shift the transmission out of park position P or neutral N and into another transmission position.</p> <ul style="list-style-type: none"> ► Depress the brake pedal. ► Start the vehicle. ► Change the transmission position.
Depress Brake to Shift to D or R	<p>* You have attempted to select transmission position D or R.</p> <ul style="list-style-type: none"> ► Depress the brake pedal. ► Select transmission position D or R.
Depress Brake to Shift to R	<p>* You have attempted to select transmission position R.</p> <ul style="list-style-type: none"> ► Depress the brake pedal. ► Select transmission position R.
Apply Brake To Park Service Required	<p>* A malfunction has occurred in the emergency power supply to park position P.</p> <ul style="list-style-type: none"> ► Consult a qualified specialist workshop. ► Until then, always select park position P manually before you switch off the engine. ► Before leaving the vehicle, apply the electric parking brake.
Risk of Vehicle Rolling Away Driver's Door Open Position P Not Selected	<p>* The driver's door is not fully closed and transmission position D, R or neutral N is selected. The vehicle may roll away.</p> <ul style="list-style-type: none"> ► Select park position P when switching off the vehicle.

524 Display messages and warning/indicator lamps

Display messages	Possible causes/consequences and ► Solutions
Risk of Vehicle Rolling Away Apply Brake to Park	<ul style="list-style-type: none">* The transmission is malfunctioning. Park position P cannot be selected.<ul style="list-style-type: none">► Park the vehicle safely.► Use the electric parking brake to secure the vehicle against rolling away.► On gradients, turn the front wheels so that the vehicle will roll towards the curb if it starts moving.
Risk of Vehicle Rolling Away N Activated Manually No Automatic Change to P	<ul style="list-style-type: none">* While the vehicle was at a standstill or driving at very low speed, neutral N was engaged with the engine running or the ignition switched on.<div data-bbox="500 464 1646 679" style="border: 1px solid black; padding: 5px;"><p>! NOTE Damage to the vehicle due to it rolling away</p><p>When the ignition is being switched off or the driver's door opened, automatic engagement of park position P is deactivated.</p><p>The vehicle may roll away.</p><ul style="list-style-type: none">► Be ready to brake.► Do not leave the vehicle unattended.</div>► Depress the brake pedal until the vehicle comes to a standstill.► Engage park position P when the vehicle is stationary with the brake pedal depressed.► To continue driving with the brake pedal depressed, select transmission position D or R.





Display messages	Possible causes/consequences and ► Solutions
<p>N Automatically Activated Please Shift to Transmission Position Again</p>	<p>* Neutral N was automatically engaged when the vehicle was rolling or being driven.</p> <ul style="list-style-type: none"> ▶  When you open the driver's door in neutral N, park position P will be engaged automatically. ▶ Depress the brake pedal until the vehicle comes to a standstill. ▶ Engage park position P when the vehicle is stationary with the brake pedal depressed. ▶ To continue driving with the brake pedal depressed, select transmission position D or R.
<p>Reversing Not Possible Service Required</p>	<p>* The transmission is malfunctioning. It is not possible to select transmission position R.</p> <ul style="list-style-type: none"> ▶ Consult a qualified specialist workshop.
<p>Transmission Malfunction Stop</p>	<p>* The transmission is malfunctioning. The transmission shifts to neutral N automatically.</p> <ul style="list-style-type: none"> ▶ Stop the vehicle immediately in accordance with the traffic conditions. ▶ Depress the brake pedal. ▶ Engage park position P. ▶ Consult a qualified specialist workshop.
<p>Service Required Do Not Change Transmission Position</p>	<p>* The transmission is malfunctioning. It is no longer possible to change the transmission position.</p> <ul style="list-style-type: none"> ▶ If transmission position D is selected, consult a qualified specialist workshop and do not change the transmission position. ▶ For all other transmission positions, park the vehicle safely. ▶ Consult a qualified specialist workshop or breakdown service.





526 Display messages and warning/indicator lamps



Display messages	Possible causes/consequences and ► Solutions
Drive Malfunction Stop Restart Vehicle	<p>* The transmission is malfunctioning.</p> <ul style="list-style-type: none">► Stop the vehicle immediately in accordance with the traffic conditions.► Restart the vehicle. <p>If the display message still appears:</p> <ul style="list-style-type: none">► Consult a qualified specialist workshop.
Drive Malfunction Stop Contact Dealer	<p>* The transmission is malfunctioning.</p> <ul style="list-style-type: none">► Stop the vehicle immediately in a safe location and do not continue driving.► Consult a qualified specialist workshop.
Drive Overheated Drive Carefully	<p>* The transmission is overheating. When the display message is active, start-up and driving characteristics may be temporarily impaired.</p> <ul style="list-style-type: none">► Drive at low engine speed.► Avoid sporty driving.► Before pulling away on uphill gradients, let the transmission cool down until the display message disappears.
Auxiliary Battery Malfunction (white display message)	<p>* There is a malfunction in the auxiliary battery.</p> <ul style="list-style-type: none">► Consult a qualified specialist workshop.► Until then, always select park position P manually before you switch off the engine.► Before leaving the vehicle, apply the electric parking brake.





Display messages	Possible causes/consequences and ► Solutions
<p>Auxiliary Battery Malfunction (red display message)</p>	<p>* There is a malfunction in the auxiliary battery.</p> <ul style="list-style-type: none"> ► Consult a qualified specialist workshop. ► Until then, always select park position P manually before you switch off the engine. ► Before leaving the vehicle, apply the electric parking brake.







Brakes

Display messages	Possible causes/consequences and ► Solutions
<div style="border: 1px solid black; padding: 5px; text-align: center; width: 80px; margin: 0 auto;"> <p>PARK</p> </div> <p>(USA only)</p> <div style="border: 1px solid black; padding: 5px; text-align: center; width: 80px; margin: 0 auto;">  </div> <p>(Canada only)</p> <p>Parking Brake See Operator's Manual</p>	<p>* The yellow  indicator lamp is lit. The electric parking brake is malfunctioning.</p> <p>To apply:</p> <ul style="list-style-type: none"> ► Switch the ignition off and switch it back on. ► Apply the electric parking brake manually (→ page 215). <p>If it is not possible to apply the electric parking brake:</p> <ul style="list-style-type: none"> ► Consult a qualified specialist workshop. ► Where necessary, also secure the parked vehicle against rolling away. <p>* The yellow  indicator lamp and the red PARK (USA only) or  (Canada only) indicator lamp are lit. The electric parking brake is malfunctioning.</p> <p>To release:</p>



Display messages	Possible causes/consequences and ► Solutions
	<ul style="list-style-type: none">► Switch the ignition off and switch it back on.► Release the electric parking brake manually (→ page 215). <p>or</p> <ul style="list-style-type: none">► Release the electric parking brake automatically (→ page 215). <p>If it is still not possible to release the electric parking brake:</p> <ul style="list-style-type: none">► Do not continue driving. Consult a qualified specialist workshop. <p>* The yellow  indicator lamp is lit and the red  (USA only) or  (Canada only) indicator lamp is flashing. The electric parking brake is malfunctioning.</p> <p>The electric parking brake could not be applied or released.</p> <ul style="list-style-type: none">► Switch the ignition off and switch it back on. <p>To apply:</p> <ul style="list-style-type: none">► Release and then apply the electric parking brake manually (→ page 215). <p>To release:</p> <ul style="list-style-type: none">► Apply and then release the electric parking brake manually. <p>If the electric parking brake cannot be applied or the red  (USA only) or  (Canada only) indicator lamp continues to flash:</p> <ul style="list-style-type: none">► Do not continue driving. Consult a qualified specialist workshop.► Where necessary, also secure the parked vehicle against rolling away.

Display messages	Possible causes/consequences and ► Solutions
	<p>* The yellow  indicator lamp is lit and the red  (USA only) or  (Canada only) indicator lamp flashes for approximately ten seconds after the electric parking brake has been applied or released. It then remains lit or goes out. The electric parking brake is malfunctioning.</p> <p>If the state of charge is too low:</p> <ul style="list-style-type: none">► Charge the 12 V battery. <p>To apply:</p> <ul style="list-style-type: none">► Apply the electric parking brake manually. <p>If it is not possible to apply the electric parking brake:</p> <ul style="list-style-type: none">► Consult a qualified specialist workshop.► Where necessary, also secure the parked vehicle against rolling away. <p>To release:</p> <ul style="list-style-type: none">► If the conditions for automatic release are fulfilled and the electric parking brake is not released automatically, release the electric parking brake manually (→ page 215). <p>If it is still not possible to release the electric parking brake:</p> <ul style="list-style-type: none">► Do not continue driving. Consult a qualified specialist workshop.

Display messages	Possible causes/consequences and ► Solutions
 <p>(USA only)</p>  <p>(Canada only)</p> <p>Please Release Parking Brake</p>	<p>* The red  indicator lamp (USA only) or  indicator lamp (Canada only) is flashing.</p> <p>The electric parking brake is applied while you are driving:</p> <ul style="list-style-type: none">• A condition for automatic release of the electric parking brake has not been fulfilled (→ page 215).• You are performing emergency braking using the electric parking brake (→ page 215). <p>► Check the conditions for automatic release of the electric parking brake.</p> <p>► Release the electric parking brake manually.</p>





Display messages	Possible causes/consequences and ► Solutions
<div data-bbox="205 252 362 335"></div> <div data-bbox="201 342 310 368">(USA only)</div> <div data-bbox="205 381 362 464"></div> <div data-bbox="201 471 343 497">(Canada only)</div> <div data-bbox="195 505 462 557">Switch on Vehicle to Release the Parking Brake</div>	<p>* The red  (USA only) or  (Canada only) indicator lamp is lit. You have attempted to release the electric parking brake with the ignition switched off.</p> <ul style="list-style-type: none"> ► Switch on the ignition.
<div data-bbox="205 584 362 667"></div> <div data-bbox="195 674 304 700">(USA only)</div> <div data-bbox="205 712 362 795"></div> <div data-bbox="195 802 338 828">(Canada only)</div> <div data-bbox="195 837 386 862">Brake Immediately</div>	<p>* A malfunction has occurred while the HOLD function was activated. A horn may also sound at regular intervals. You cannot start the engine.</p> <ul style="list-style-type: none"> ► Immediately depress the brake pedal firmly until the display message disappears. You can restart the engine.



532 Display messages and warning/indicator lamps

Display messages	Possible causes/consequences and ► Solutions
 <p>(USA only)</p>  <p>(Canada only)</p> <p>Check Brake Fluid Level</p>	<p>* There is insufficient brake fluid in the brake fluid reservoir.</p> <div style="border: 1px solid gray; padding: 5px;"><p>▲ WARNING Risk of an accident due to low brake fluid level</p><p>If the brake fluid level is too low, the braking effect and the braking characteristics may be impaired.</p><ul style="list-style-type: none">▶ Pull over and stop the vehicle safely as soon as possible, paying attention to road and traffic conditions. Do not continue driving under any circumstances.▶ Consult a qualified specialist workshop.▶ Do not add brake fluid.</div>
<p>Check Brake Pads See Operator's Manual</p>	<p>* The brakepads have reached the wear limit.</p> <ul style="list-style-type: none">▶ Consult a qualified specialist workshop.

Driving systems

Display messages	Possible causes/consequences and ► Solutions
 <p>Off</p>	<p>* The HOLD function is deactivated because the vehicle is slipping or a condition for activation is not fulfilled.</p> <ul style="list-style-type: none">▶ Reactivate the HOLD function later or check the activation conditions for the HOLD function (→ page 223).

Display messages	Possible causes/consequences and ► Solutions
 <p data-bbox="195 342 473 391">ATTENTION ASSIST Inoperative</p>	<p data-bbox="519 249 924 272">* ATTENTION ASSIST is malfunctioning.</p> <ul style="list-style-type: none"> <li data-bbox="543 283 975 306">► Consult a qualified specialist workshop.
 <p data-bbox="195 510 473 559">ATTENTION ASSIST: Take a Break!</p>	<p data-bbox="519 417 1578 466">* ATTENTION ASSIST has detected fatigue or an increasing lack of concentration on the part of the driver (→ page 224).</p> <ul style="list-style-type: none"> <li data-bbox="543 477 842 500">► If necessary, take a break.
 <p data-bbox="195 676 449 725">ATTENTION ASSIST Nodding Off Take a Break!</p>	<p data-bbox="519 583 1273 606">* ATTENTION ASSIST has detected indicators of microsleep (→ page 224).</p> <p data-bbox="543 617 855 640">A warning tone will also sound.</p> <ul style="list-style-type: none"> <li data-bbox="543 651 1119 674">► It is recommended that you take a break immediately. <li data-bbox="543 685 1310 708">► Press the left-hand Touch Control and acknowledge the display message.
 <p data-bbox="195 842 282 865">--- mph</p>	<p data-bbox="519 749 1526 771">* Active Distance Assist DISTRONIC cannot be activated as not all activation conditions are fulfilled.</p> <ul style="list-style-type: none"> <li data-bbox="543 783 1485 806">► Comply with the activation conditions of Active Distance Assist DISTRONIC (→ page 228).

Display messages	Possible causes/consequences and ► Solutions
 <p>Suspended</p>	<p>* If you depress the accelerator pedal beyond the setting of Active Distance Assist DISTRONIC, the system will switch to passive mode (→ page 226).</p>
 <p>Off</p>	<p>* Active Distance Assist DISTRONIC was deactivated. If a warning tone also sounds, Active Distance Assist DISTRONIC has deactivated automatically (→ page 228).</p>
<p>Active Distance Assist Currently Unavailable See Operator's Manual</p>	<p>* Active Distance Assist DISTRONIC is temporarily unavailable. The ambient conditions are outside the system limits (→ page 226). As soon as the ambient conditions are within the system limits, the system will become available again.</p> <p>► Drive on or ► If the display message does not disappear, stop the vehicle in accordance with the traffic conditions and restart the vehicle.</p>
<p>Active Distance Assist Inoperative</p>	<p>* Active Distance Assist DISTRONIC is malfunctioning. Other driving systems and driving safety systems may also be malfunctioning.</p> <p>► Drive on</p>

Display messages	Possible causes/consequences and ► Solutions
	<p>or</p> <ul style="list-style-type: none"> ► Stop the vehicle in accordance with the traffic conditions and restart the vehicle. ► If the display message does not disappear: consult a qualified specialist workshop.
Active Distance Assist Now Available	<ul style="list-style-type: none"> * Active Distance Assist DISTRONIC is operational again. <ul style="list-style-type: none"> ► Switch on Active Distance Assist DISTRONIC (→ page 228).
Active Steering Assist Currently Unavailable See Operator's Manual	<ul style="list-style-type: none"> * Active Steering Assist is temporarily unavailable. The ambient conditions are outside the system limits (→ page 233). As soon as the ambient conditions are within the system limits, the system will become available again. <ul style="list-style-type: none"> ► Drive on ► Check the tire pressure if necessary.
Active Steering Assist Inoperative	<ul style="list-style-type: none"> * Active Steering Assist is malfunctioning. Active Distance Assist DISTRONIC remains available. <ul style="list-style-type: none"> ► Drive on <p>or</p> <ul style="list-style-type: none"> ► Stop the vehicle in accordance with the traffic conditions and restart the vehicle. ► If the display message does not disappear: consult a qualified specialist workshop.
	<ul style="list-style-type: none"> * Active Steering Assist has reached the system limits (→ page 233). You have not steered independently for a considerable period of time. <ul style="list-style-type: none"> ► Take over the steering and drive on in accordance with the traffic conditions.





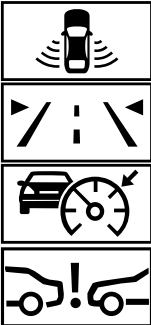

Display messages	Possible causes/consequences and ► Solutions
<p>Active Steering Assist Currently Unavailable Due to Multiple Emergency Stops</p>	<ul style="list-style-type: none"> * Active Steering Assist is temporarily unavailable due to multiple emergency stops. <ul style="list-style-type: none"> ► Take over the steering and stop in accordance with the traffic conditions. ► Switch the ignition off and switch it back on. ► Active Steering Assist is available once more.
<div style="text-align: center;">  </div> <p>Beginning Emergency Stop</p>	<ul style="list-style-type: none"> * Your hands are not on the steering wheel. The Active Steering Assist will initiate an emergency stop (→ page 233). <ul style="list-style-type: none"> ► Put your hands on the steering wheel. Information on canceling an emergency stop (→ page 235).
<p>Active Emergency Stop Assist Currently Unavailable See Operator's Manual</p>	<ul style="list-style-type: none"> * Active Emergency Stop Assist is temporarily unavailable. The ambient conditions are outside the system limits (→ page 235). As soon as the ambient conditions are within the system limits, the system will become available again. <ul style="list-style-type: none"> ► Drive on or ► If the display message does not disappear, stop the vehicle in accordance with the traffic conditions and restart the vehicle.
<p>Active Emergency Stop Assist Inoperative</p>	<ul style="list-style-type: none"> * Active Emergency Stop Assist is malfunctioning. <ul style="list-style-type: none"> ► Drive on. or

Display messages	Possible causes/consequences and ► Solutions
	<ul style="list-style-type: none"> ► Stop the vehicle in accordance with the traffic conditions and restart the vehicle. ► If the display message does not disappear: consult a qualified specialist workshop.
<p>Active Lane Change Assist Currently Unavailable See Operator's Manual</p>	<p>* Active Lane Change Assist is temporarily unavailable. The ambient conditions are outside the system limits (→ page 237). As soon as the ambient conditions are within the system limits, the system will become available again.</p> <ul style="list-style-type: none"> ► Drive on or ► If the display message does not disappear, stop the vehicle in accordance with the traffic conditions and restart the vehicle.
<p>Active Lane Change Assist Inoperative</p>	<p>* Active Lane Change Assist is malfunctioning.</p> <ul style="list-style-type: none"> ► Drive on or ► Stop the vehicle in accordance with the traffic conditions and restart the vehicle. ► If the display message does not disappear: consult a qualified specialist workshop.
<p>Active Stop & Go Assist Currently Unavailable See Operator's Manual</p>	<p>* Active Stop-and-Go Assist is temporarily unavailable. Active Distance Assist DISTRONIC and Active Steering Assist are still available. The ambient conditions are outside the system limits (→ page 226). As soon as the ambient conditions are within the system limits, the system will become available again.</p> <ul style="list-style-type: none"> ► Drive on.

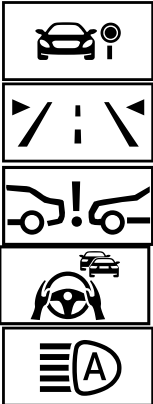
Display messages	Possible causes/consequences and ► Solutions
<p>Active Stop & Go Assist Inoperative See Operator's Manual</p>	<p>* Active Stop-and-Go Assist is malfunctioning. Active Stop-and-Go Assist has been deactivated. Active Distance Assist DISTRONIC and Active Steering Assist are still available.</p> <ul style="list-style-type: none"> ► Drive on. or ► Stop the vehicle in accordance with the traffic conditions and restart the vehicle. ► If the display message does not disappear: consult a qualified specialist workshop.
<p>Traffic Sign Assist Currently Unavailable See Operator's Manual</p>	<p>* Traffic Sign Assist is temporarily unavailable. Once the cause of the problem is no longer present, the system will be available again.</p> <ul style="list-style-type: none"> ► Drive on
<p>Traffic Sign Assist Inoperative</p>	<p>* Traffic Sign Assist is malfunctioning.</p> <ul style="list-style-type: none"> ► Drive on or ► Stop the vehicle in accordance with the traffic conditions and restart the vehicle. ► If the display message does not disappear: consult a qualified specialist workshop.
<p>Active Blind Spot Assist Currently Unavailable See Operator's Manual</p>	<p>* Active Blind Spot Assist is temporarily unavailable. The system limits have been reached (→ page 250). Once the cause of the problem is no longer present, the system will be available again.</p>

Display messages	Possible causes/consequences and ► Solutions
	<ul style="list-style-type: none"> ► Drive on or ► If the display message does not disappear, stop the vehicle in accordance with the traffic conditions and restart the vehicle.
Active Blind Spot Assist Inoperative	<ul style="list-style-type: none"> * Active Blind Spot Assist is malfunctioning. ► Drive on or ► Stop the vehicle in accordance with the traffic conditions and restart the vehicle. ► If the display message does not disappear: consult a qualified specialist workshop.
Active Lane Keeping Assist Currently Unavailable See Operator's Manual	<ul style="list-style-type: none"> * Active Lane Keeping Assist is temporarily unavailable. The ambient conditions are outside the system limits (→ page 254). As soon as the ambient conditions are within the system limits, the system will become available again. ► Drive on
Active Lane Keeping Assist Inoperative	<ul style="list-style-type: none"> * Active Lane Keeping Assist is malfunctioning. ► Drive on or ► Stop the vehicle in accordance with the traffic conditions and restart the vehicle. ► If the display message does not disappear: consult a qualified specialist workshop.

Display messages	Possible causes/consequences and ► Solutions
 <p data-bbox="144 598 389 647">Temporarily Unavailable Radar Dirty</p>	<p data-bbox="476 249 1517 272">* Front and corner radar sensors and/or lidar (hereafter "sensors") are malfunctioning. Possible causes:</p> <ul data-bbox="500 285 1169 376" style="list-style-type: none"> <li data-bbox="500 285 864 308">• The sensors are dirty or damaged <li data-bbox="500 319 722 341">• Heavy rain or snow <li data-bbox="500 352 1169 376">• Extended country driving without other traffic, e.g. in the desert <p data-bbox="495 396 1618 443">Driving systems and driving safety systems may be malfunctioning or temporarily unavailable. The brake system, steering and drive system will continue to function normally.</p> <p data-bbox="495 456 620 479">► Drive on.</p> <p data-bbox="495 505 1641 552">Once the causes of the problem are no longer present, the driving systems and driving safety systems will be available again and the corresponding symbols will be switched off.</p> <p data-bbox="495 567 924 590">If the display message does not disappear:</p> <ul data-bbox="495 603 1313 692" style="list-style-type: none"> <li data-bbox="495 603 1105 626">► Stop the vehicle in accordance with the traffic conditions. <li data-bbox="495 637 1313 659">► Clean all sensor covers from the outside and check for damage (→ page 218). <li data-bbox="495 670 722 692">► Restart the vehicle.



Display messages	Possible causes/consequences and ► Solutions
 <p data-bbox="195 681 439 733">Temporarily Unavailable Camera View Restricted</p>	<p data-bbox="528 249 1221 270">* The view of the multifunction camera is restricted. Possible causes:</p> <ul data-bbox="550 285 1646 401" style="list-style-type: none"> <li data-bbox="550 285 1286 306">• Dirt on the windshield in the field of vision of the multifunction camera <li data-bbox="550 317 814 337">• Heavy rain, snow or fog <li data-bbox="550 348 1646 401">• Condensation on the inside of the windshield: in certain weather conditions, condensation can form on the inside of the windshield during cold times of year in particular. <p data-bbox="550 420 1689 472">  This condensation on the windshield will be removed automatically within a short time with the aid of a heater. The restriction is temporary. </p> <p data-bbox="547 482 1665 534">Driving systems and driving safety systems may be malfunctioning or temporarily unavailable. The brake system, steering and drive system will continue to function normally.</p> <p data-bbox="547 544 667 565">  Drive on. </p> <p data-bbox="547 591 1689 643">Once the causes of the problem are no longer present, the driving systems and driving safety systems will be available again and the corresponding symbols will be switched off.</p> <p data-bbox="547 653 972 674">If the display message does not disappear:</p> <ul data-bbox="547 689 1480 783" style="list-style-type: none"> <li data-bbox="547 689 1156 710">  Stop the vehicle in accordance with the traffic conditions. <li data-bbox="547 721 1480 741">  Clean the windshield, especially in the position of the multifunction camera (→ page 218). <li data-bbox="547 752 772 772">  Restart the vehicle.
<p data-bbox="195 798 469 871">Driver Camera View Currently Restricted See Operator's Manual</p>	<p data-bbox="528 798 1129 819">* The view of the driver camera is reduced. Possible causes:</p> <ul data-bbox="550 829 1304 850" style="list-style-type: none"> <li data-bbox="550 829 1304 850">• Objects or stickers are projecting into the driver camera's field of vision.



542 Display messages and warning/indicator lamps



Display messages	Possible causes/consequences and ► Solutions
	<ul style="list-style-type: none"> • The driver camera is dirty. ► Keep the driver camera's field of vision free. ► Clean the driver camera if necessary. Please comply with the notes on caring for the interior relating to the display (→ page 348).
<p>Change the steering wheel/ seat position until 6 dots are visible on the upper edge of the screen.</p>	<p>* The driver camera cannot capture your line of sight.</p> <ul style="list-style-type: none"> ► Change the steering wheel and seat position until six dots are visible on the top edge of the screen.
<p>Driver Camera Inoperative See Operator's Manual</p>	<p>* The driver camera is malfunctioning.</p> <ul style="list-style-type: none"> ► Consult a qualified specialist workshop.
<div data-bbox="155 596 312 679" data-label="Image"> </div> <p>Malfunction Drive at Max. 50 mph</p>	<p>* AIRMATIC is functioning only to a limited extent. The vehicle's handling characteristics may be affected.</p> <div data-bbox="500 638 1646 783" data-label="Complex-Block" style="border: 1px solid gray; padding: 5px;"> <p>! NOTE The tires on the front axle or the fenders could be damaged by large steering movements</p> <ul style="list-style-type: none"> ► Avoid large steering movements while driving and listen for scraping sounds. ► If you hear scraping sounds, pull over and stop the vehicle in accordance with the traffic conditions, and set a higher vehicle level if possible. </div> <ul style="list-style-type: none"> ► Drive in a manner appropriate for the current level, but do not exceed 50 mph (80 km/h). ► Consult a qualified specialist workshop.

Display messages	Possible causes/consequences and ► Solutions
<p>E-ACTIVE BODY CONTROL Function Limited See Operator's Manual</p>	<p>* At least one main function of the E-ACTIVE BODY CONTROL system is malfunctioning. The system is outside the operating temperature range or the on-board electrical system voltage is too low. Once the cause of the problem is no longer present, the system will be available again.</p> <div style="border: 1px solid black; padding: 5px;"> <p>! NOTE The vehicle's suspension and damping behavior is restricted. The vehicle body may tilt heavily to the side during cornering.</p> <ul style="list-style-type: none"> ► Drive on carefully. ► Reduce speed considerably before taking a bend. ► Avoid sudden steering movements. </div> <ul style="list-style-type: none"> ► Drive on carefully. ► Reduce speed considerably before taking a curve. ► Avoid sudden steering movements.
<div style="border: 1px solid black; width: 40px; height: 40px; margin: 0 auto; display: flex; align-items: center; justify-content: center;">  </div> <p>Malfunction Drive at Max. 50 mph</p>	<p>* At least one main function of the E-ACTIVE BODY CONTROL system is malfunctioning. The system is deactivated.</p> <div style="border: 1px solid black; padding: 5px;"> <p>! NOTE The vehicle's suspension and damping behavior has changed significantly, the vehicle body may tilt heavily to the side during cornering.</p> <ul style="list-style-type: none"> ► Reduce vehicle speed. Drive on carefully. </div>

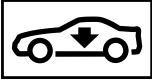
544 Display messages and warning/indicator lamps

Display messages	Possible causes/consequences and ► Solutions
	<ul style="list-style-type: none">▶ Reduce the vehicle speed considerably before taking a curve.▶ Avoid sudden steering movements.► Continue driving carefully and do not exceed 50 mph (80 km/h).► If possible, stop the vehicle in accordance with the traffic conditions and switch the ignition off and on again.► If the display message still appears, consult a qualified specialist workshop.
 <p data-bbox="144 547 319 570">Malfunction Stop</p>	<p data-bbox="476 453 1452 508">* There is a serious malfunction affecting the hydraulics of the E-ACTIVE BODY CONTROL system. The system is deactivated.</p> <div data-bbox="500 529 1648 570"><p> NOTE The vehicle's driving characteristics have changed significantly.</p></div> <ul style="list-style-type: none">▶ Pull over and stop the vehicle safely as soon as possible in accordance with the traffic conditions. Do not continue driving under any circumstances.► Stop the vehicle immediately in accordance with the traffic conditions. Do not continue driving under any circumstances.► Consult a qualified specialist workshop.

Display messages	Possible causes/consequences and ► Solutions
 <p data-bbox="195 343 445 368">Maximum Speed 12mph</p>	<p data-bbox="524 250 1581 275">* AIRMATIC is functioning only to a limited extent. The vehicle's handling characteristics may be affected.</p> <ul style="list-style-type: none"> <li data-bbox="543 283 1424 310">► The current level is too high. Do not drive at speeds greater than 12 mph (20 km/h). <li data-bbox="543 319 977 346">► Consult a qualified specialist workshop.
 <p data-bbox="195 486 436 532">STOP Vehicle Level Too Low</p>	<p data-bbox="524 393 1151 418">* You have pulled away despite the vehicle level being too low.</p> <ul style="list-style-type: none"> <li data-bbox="543 426 1158 476">► Stop the vehicle in accordance with the traffic conditions. The vehicle will be raised to the selected vehicle level. <li data-bbox="543 484 1204 511">► Wait until the display message disappears before pulling away. <p data-bbox="543 538 1581 563">If the display message does not disappear and a warning tone also sounds, AIRMATIC is malfunctioning:</p> <ul style="list-style-type: none"> <li data-bbox="543 571 1702 598">► Do not drive at speeds greater than 50 mph (80 km/h) and consult a qualified specialist workshop immediately. <div data-bbox="550 623 1696 768" style="border: 1px solid black; padding: 5px;"> <p data-bbox="561 631 1563 656">! NOTE The tires on the front axle or the fenders could be damaged by large steering movements</p> <ul style="list-style-type: none"> <li data-bbox="561 673 1363 700">► Avoid large steering movements while driving and listen for scraping sounds. <li data-bbox="561 708 1641 758">► If you hear scraping sounds, pull over and stop the vehicle in accordance with the traffic conditions, and set a higher vehicle level if possible. </div> <ul style="list-style-type: none"> <li data-bbox="543 785 1147 835">► Set a higher vehicle level (→ page 257). Depending on the malfunction, the vehicle will be raised.



Display messages	Possible causes/consequences and ► Solutions
 <p>Vehicle Rising Please Wait</p>	<ul style="list-style-type: none"> * The vehicle level is too low. The vehicle will be raised to the selected vehicle level. <ul style="list-style-type: none"> ► Wait until the display message disappears before pulling away.
 <p>Compressor Is Cooling</p>	<ul style="list-style-type: none"> * Due to frequent level changes within a short space of time, the compressor first needs to cool down in order to set the selected vehicle level. When the compressor has cooled down, the vehicle will continue rising to the selected vehicle level. <ul style="list-style-type: none"> ► Drive on in a manner appropriate for the current level. Make sure that there is sufficient ground clearance.
<p>Active Parking Assist Limited Availability of Maneuvering Assistance See Operator's Manual</p>	<ul style="list-style-type: none"> * Active Parking Assist's maneuvering assistant is temporarily unavailable or only partially available. <ul style="list-style-type: none"> ► Clean all sensors of the parking and camera system (→ page 346). ► If the display message still appears, consult a qualified specialist workshop.
<p>PARKTRONIC Inoperative See Operator's Manual</p>	<ul style="list-style-type: none"> * Parking Assist PARKTRONIC is malfunctioning. Once the cause of the problem is no longer present, the system will be available again. <ul style="list-style-type: none"> ► Continue driving while paying attention to the vehicle's surroundings. or ► Stop the vehicle in accordance with the traffic conditions and restart the vehicle. ► If the display message still appears, consult a qualified specialist workshop.

Display messages	Possible causes/consequences and ► Solutions
<p>Active Parking Assist and PARKTRONIC Inoperative See Operator's Manual</p>	<p>* Active Parking Assist and Parking Assist PARKTRONIC are malfunctioning. Once the cause of the problem is no longer present, the system will be available again.</p> <ul style="list-style-type: none"> ► Continue driving while paying attention to the vehicle's surroundings. <p>or</p> <ul style="list-style-type: none"> ► Stop the vehicle in accordance with the traffic conditions and restart the vehicle. ► If the display message still appears, consult a qualified specialist workshop.

Driving safety systems

Display messages	Possible causes/consequences and ► Solutions
<div data-bbox="205 591 362 669" data-label="Image"> </div> <div data-bbox="205 677 362 759" data-label="Image"> </div> <p>Currently Unavailable See Operator's Manual</p>	<p>* ABS and ESP® are temporarily unavailable. Other driving systems and driving safety systems (e.g. BAS) may also be temporarily unavailable. The brake system will continue to operate normally. Braking distance may increase in an emergency braking situation.</p> <div data-bbox="550 729 1696 774" data-label="Text" style="background-color: #f0f0f0; padding: 5px;"> <p>⚠ WARNING Risk of skidding if ABS and ESP® are malfunctioning</p> </div> <p>The wheels may lock during braking and ESP® does not perform any vehicle stabilization. The steerability and braking characteristics are heavily impaired and the braking distance may increase. In addition, other driving safety systems are switched off.</p>

Display messages	Possible causes/consequences and ► Solutions
	<ul style="list-style-type: none"> ► Drive carefully on a suitable stretch of road, making slight steering movements at a speed above 19 mph (30 km/h). ► If the display message does not disappear, consult a qualified specialist workshop immediately. Drive carefully.
<div style="display: flex; align-items: center;">  <div style="margin-left: 10px;"> <p>Inoperative See Operator's Manual</p> </div> </div>	<p>* ABS and ESP® are malfunctioning. Other driving systems and driving safety systems (e.g. BAS) may also be malfunctioning. The brake system will continue to operate normally. Braking distance may increase in an emergency braking situation.</p> <div style="background-color: #f0f0f0; padding: 5px; margin-bottom: 10px;"> <p>▲ WARNING Risk of skidding if ABS and ESP® are malfunctioning</p> </div> <p>The wheels may block during braking and ESP® does not perform any vehicle stabilization. The steerability and braking characteristics are heavily impaired and the braking distance may increase. In addition, other driving safety systems are switched off.</p> <ul style="list-style-type: none"> ► Drive on carefully. ► Have ABS and ESP® checked immediately at a qualified specialist workshop.

Display messages	Possible causes/consequences and ► Solutions
 <p data-bbox="195 344 458 394">Currently Unavailable See Operator's Manual</p>	<p data-bbox="528 251 1424 313">* ESP® is temporarily unavailable. Other driving systems and driving safety systems (e.g. BAS) may also be malfunctioning.</p> <div data-bbox="550 329 1702 567" style="border: 1px solid gray; padding: 5px;"> <p data-bbox="559 339 1134 366">▲ WARNING Risk of skidding if ESP is malfunctioning®</p> <p data-bbox="559 381 1665 433">If ESP® is malfunctioning, ESP® cannot carry out vehicle stabilization. In addition, other driving safety systems are switched off.</p> <ul data-bbox="559 446 1665 557" style="list-style-type: none"> <li data-bbox="559 446 1641 495">► Drive carefully on a suitable stretch of road, making slight steering movements at a speed above 19 mph (30 km/h). <li data-bbox="559 505 1665 557">► If the display message does not disappear, consult a qualified specialist workshop immediately. Drive carefully. </div>
 <p data-bbox="195 676 467 726">Inoperative See Operator's Manual</p>	<p data-bbox="528 588 1689 702">* ESP® is malfunctioning. Other driving systems and driving safety systems (e.g. BAS) may also be malfunctioning. The brake system will continue to operate normally. Braking distance may increase in an emergency braking situation.</p> <div data-bbox="550 717 1702 875" style="border: 1px solid gray; padding: 5px;"> <p data-bbox="559 728 1134 755">▲ WARNING Risk of skidding if ESP® is malfunctioning</p> <p data-bbox="559 769 1665 821">If ESP® is malfunctioning, ESP® cannot carry out vehicle stabilization. In addition, other driving safety systems are switched off.</p> <ul data-bbox="559 835 778 861" style="list-style-type: none"> <li data-bbox="559 835 778 861">► Drive on carefully. </div>

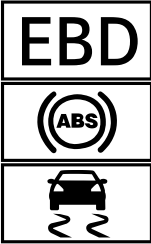
Display messages	Possible causes/consequences and ► Solutions
	<p>► Have ESP® checked at a qualified specialist workshop.</p>
 <p>Inoperative See Operator's Manual</p>	<p>* EBD, ABS and ESP® are malfunctioning. Other driving systems and driving safety systems (e.g. BAS) may also be malfunctioning.</p> <p>▲ WARNING Risk of skidding if EBD, ABS and ESP® are malfunctioning</p> <p>The wheels may block during braking and ESP® does not perform any vehicle stabilization. The steerability and braking characteristics are heavily impaired and the braking distance may increase. In addition, other driving safety systems are switched off.</p> <p>► Drive on carefully. ► Have the brake system checked immediately at a qualified specialist workshop.</p>
<p>Active Brake Assist Functions Currently Limited See Operator's Manual</p>	<p>* For vehicles with the Driving Assistance Package, the following functions may be temporarily unavailable or only partially available:</p> <ul style="list-style-type: none"> • Active Brake Assist with cross-traffic function • Evasive Steering Assist • PRE-SAFE® PLUS <p>The ambient conditions are outside the system limits (→ page 239).</p>

Display messages	Possible causes/consequences and ► Solutions
	<p>► Drive on. As soon as the ambient conditions are within the system limits, the system will become available again.</p> <p>or</p> <p>► If the display message does not disappear, stop the vehicle in accordance with the traffic conditions and restart the vehicle.</p>
<p>Active Brake Assist Functions Limited See Operator's Manual</p>	<p>* For vehicles with the Driving Assistance Package, the following functions may be temporarily unavailable or only partially available:</p> <ul style="list-style-type: none"> • Active Brake Assist with cross-traffic function • Evasive Steering Assist • PRE-SAFE® PLUS <p>► Drive on</p> <p>or</p> <p>► Stop the vehicle in accordance with the traffic conditions and restart the vehicle.</p> <p>► If the display message does not disappear: consult a qualified specialist workshop.</p>



Mercedes-Benz emergency call system

Display messages	Possible causes/consequences and ► Solutions
 <p data-bbox="144 381 260 405">Inoperative</p>	<p data-bbox="473 288 1628 339">* The Mercedes-Benz emergency call system malfunctioning The Mercedes me connect system is also malfunctioning.</p> <ul style="list-style-type: none"> <li data-bbox="491 350 925 373">► Consult a qualified specialist workshop.

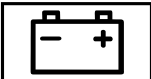
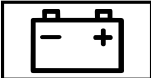
Battery

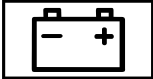
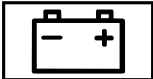
Display messages	Possible causes/consequences and ► Solutions
 <p data-bbox="144 650 399 702">12 V On-board Electrical System Service Required</p>	<p data-bbox="473 557 1036 581">* The 12 V on-board electrical system is malfunctioning.</p> <ul style="list-style-type: none"> <li data-bbox="491 591 1055 615">► Consult a qualified specialist workshop immediately.
 <p data-bbox="144 819 389 871">Stop Vehicle See Operator's Manual</p>	<p data-bbox="473 726 1245 750">* The 12 V battery is no longer being charged and the charge level is too low.</p> <div data-bbox="495 767 1646 860" style="border: 1px solid black; padding: 5px;"> <p data-bbox="506 778 1092 801">! NOTE Possible engine damage if you continue driving</p> <ul style="list-style-type: none"> <li data-bbox="506 819 1045 843">► Do not continue driving under any circumstances. </div>

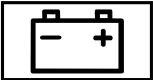

Display messages	Possible causes/consequences and ► Solutions
	<ul style="list-style-type: none"> ► Consult a qualified specialist workshop. <ul style="list-style-type: none"> ► Stop the vehicle immediately in accordance with the traffic conditions. Do not continue driving under any circumstances. ► Switch off the engine. ► Consult a qualified specialist workshop.
 <p data-bbox="195 539 436 588">Switch on vehicle to charge the 12 V battery</p>	<p data-bbox="522 446 1252 469">* The vehicle is off and the state of charge of the 12 V battery is too low.</p> <ul style="list-style-type: none"> ► Switch off electrical consumers that are not required. <p data-bbox="545 531 814 554">To charge the 12 V battery:</p> <ul style="list-style-type: none"> ► Leave the vehicle running for a few minutes, or drive an extended distance.
 <p data-bbox="195 705 463 780">Stop vehicle To charge the 12 V battery do not switch off vehicle</p>	<p data-bbox="522 612 944 635">* The 12 V battery charge level is too low.</p> <ul style="list-style-type: none"> ► Stop the vehicle immediately in accordance with the traffic conditions. Do not continue driving. ► Leave the engine running. ► If the display message disappears: drive on. ► If the display message does not disappear: consult a qualified specialist workshop.



Display messages	Possible causes/consequences and ► Solutions
 <p data-bbox="144 342 393 391">Stop Vehicle See Operator's Manual</p>	<p data-bbox="473 249 1036 272">* The 48 V on-board electrical system is malfunctioning.</p> <ul style="list-style-type: none"> <li data-bbox="495 282 1480 305">► Stop the vehicle immediately in accordance with the traffic conditions. Do not continue driving. <li data-bbox="495 315 750 338">► Switch off the engine. <li data-bbox="495 349 925 371">► Consult a qualified specialist workshop.
 <p data-bbox="144 513 393 562">48 V Battery See Operator's Manual</p>	<p data-bbox="473 420 1600 464">* The 48 V on-board electrical system has function restrictions. The availability of convenience functions may be restricted.</p> <ul style="list-style-type: none"> <li data-bbox="495 474 1018 497">► Visit a qualified specialist workshop immediately.
 <p data-bbox="144 679 412 728">Please Wait Charging 48 V Battery...</p>	<p data-bbox="473 586 1637 635">* The 48 V battery is discharged. You have switched on the ignition while the 12 V battery was being charged with a suitable charger or while another vehicle was providing starting assistance.</p> <p data-bbox="495 645 1637 694">The discharged 48 V battery is charged automatically via the voltage converter. After a few minutes, the driver display will show the Starting Possible Again display message.</p> <ul style="list-style-type: none"> <li data-bbox="495 704 704 727">► Start the vehicle. <li data-bbox="495 737 1609 786">► Drive the vehicle for a while to charge the 12 V battery and the 48 V battery after disconnecting the charger from the vehicle. <p data-bbox="495 817 1328 840">If the Starting Possible Again display message does not appear after a few minutes:</p> <ul style="list-style-type: none"> <li data-bbox="495 850 759 873">► Try to start the vehicle.

Display messages	Possible causes/consequences and ► Solutions
	<ul style="list-style-type: none"> ► If the vehicle does not start, consult a qualified specialist workshop.
Cannot Start Vehicle See Operator's Manual	<ul style="list-style-type: none"> * The state of charge of the 48 V battery is too low. You can no longer start the vehicle. <ul style="list-style-type: none"> ► Switch off electrical consumers that are not required. ► Connect a suitable charger approved for Mercedes-Benz with sufficient charge output to the jump-start connection point of the 12 V battery (→ page 361). The 48 V battery is charged via the voltage converter in the vehicle.
Starting Possible Again	<ul style="list-style-type: none"> * The 48 V battery has been charged automatically via the voltage converter. <ul style="list-style-type: none"> ► Start the vehicle and drive for a while to charge the 12 V battery and the 48 V battery.

Tire pressure monitor



Display messages	Possible causes/consequences and ► Solutions
Tire Press. Monitor Currently Unavailable	<ul style="list-style-type: none"> * There is interference from a powerful radio signal source. As a result, no signals from the tire pressure sensors are being received. The tire pressure monitoring system is temporarily unavailable. The tire pressure monitoring system will restart automatically as soon as the cause has been rectified. <ul style="list-style-type: none"> ► Drive on.
Tire Press. Monitor Inoperative	<ul style="list-style-type: none"> * The tire pressure monitoring system is malfunctioning.



Display messages	Possible causes/consequences and ► Solutions
	<p>▲ WARNING There is a risk of an accident if the tire pressure monitoring system is malfunctioning</p> <p>The tire pressure monitoring system cannot issue a warning if there is pressure loss in one or more of the tires. Tires with insufficient tire pressure may impair the driving characteristics as well as steering and braking.</p> <p>► Have the tire pressure monitoring system checked at a qualified specialist workshop.</p>
<p>Tire Pressure Monitor Inoperative No Wheel Sensors</p>	<p>* The wheels installed do not have suitable tire pressure sensors. The tire pressure monitoring system is deactivated.</p> <p>► Install wheels with suitable tire pressure sensors.</p>
 <p>Wheel Sensor(s) Missing</p>	<p>* There is no signal from the tire pressure sensor of one or more wheels. No pressure value is displayed for the affected tire.</p> <p>► Have the faulty tire pressure sensor replaced at a qualified specialist workshop.</p>
 <p>Check Tires</p>	<p>* The tire pressure in one or more tires has dropped significantly. The wheel position is displayed. A warning tone will also sound.</p> <p>▲ WARNING Risk of an accident due to insufficient tire pressure</p> <ul style="list-style-type: none"> • The tires can burst. • The tires can wear excessively and/or unevenly. • The driving characteristics as well as the steering and braking may be greatly impaired.

Display messages	Possible causes/consequences and ► Solutions
	<p>You could then lose control of the vehicle.</p> <ul style="list-style-type: none"> ► Observe the recommended tire pressures. ► Adjust the tire pressure if necessary. <ul style="list-style-type: none"> ► Stop the vehicle in accordance with the traffic conditions. ► Check the tire pressure (→ page 375) and the tires.
 <p>Please Correct Tire Pressure</p>	<p>* The tire pressure is too low in at least one of the tires, or the difference in tire pressure between the individual wheels is too great.</p> <ul style="list-style-type: none"> ► Check the tire pressure and add air, if necessary. ► When the tire pressure is correct, restart the tire pressure monitor (→ page 379).
 <p>Warning Tire Malfunction</p>	<p>* The tire pressure in one or more tires has dropped suddenly. The wheel position will be displayed.</p> <div style="background-color: #e0e0e0; padding: 5px; margin-bottom: 10px;"> <p>⚠ WARNING Risk of an accident from driving with a flat tire</p> <ul style="list-style-type: none"> • The tires can overheat and be damaged. • The driving characteristics as well as the steering and braking characteristics may be greatly impaired. </div> <p>You could then lose control of the vehicle.</p> <ul style="list-style-type: none"> ► Do not drive with a flat tire.

Display messages	Possible causes/consequences and ► Solutions
	<ul style="list-style-type: none"> ► Do not exceed the maximum permissible driving distance in emergency mode and the maximum permissible speed with a flat MOExtended tire. ► Observe the notes on flat tires. <p>Notes in the event of a flat tire (→ page 351).</p> <ul style="list-style-type: none"> ► Stop the vehicle in accordance with the traffic conditions. ► Check the tires.
Tires Overheated	<p>* At least one tire is overheating. The affected tires are displayed in red. At temperatures close to the limit value, the tires are displayed in yellow.</p> <p>▲ WARNING Risk of an accident from driving with overheated tires</p> <p>Overheated tires can burst.</p> <ul style="list-style-type: none"> ► Reduce speed so that the tires cool down.
Decrease Speed	<p>* At least one tire is overheating. The affected tires are displayed in red. At temperatures close to the limit value, the tires are displayed in yellow.</p> <p>▲ WARNING Risk of an accident from driving with overheated tires</p> <p>Overheated tires can burst.</p> <ul style="list-style-type: none"> ► Reduce speed so that the tires cool down.

Engine oil

Display messages	Possible causes/consequences and ► Solutions
 <p data-bbox="195 408 426 456">Check Engine Oil Level (Add 1 quart)</p>	<p data-bbox="526 314 1088 337">* The engine oil level has dropped to the minimum level.</p> <div data-bbox="550 356 1696 443" style="border: 1px solid gray; padding: 5px;"> <p data-bbox="559 366 1273 391">! NOTE Engine damage caused by driving with insufficient engine oil</p> <p data-bbox="559 408 1068 433">► Avoid long journeys with insufficient engine oil.</p> </div> <p data-bbox="541 459 1254 484">► When next refueling, add 1.1 US qt (1 l) of engine oil (→ page 340).</p> <p data-bbox="541 501 892 526">Notes on engine oil (→ page 497).</p>
 <p data-bbox="195 638 473 686">Engine Oil Level Reduce Oil Level</p>	<p data-bbox="526 544 851 567">* The engine oil level is too high.</p> <div data-bbox="550 586 1696 673" style="border: 1px solid gray; padding: 5px;"> <p data-bbox="559 596 1230 621">! NOTE Engine damage caused by driving with excess engine oil</p> <p data-bbox="559 638 1027 663">► Avoid long journeys with excess engine oil.</p> </div> <p data-bbox="541 689 1480 714">► Consult a qualified specialist workshop immediately and have the engine oil level reduced.</p>
 <p data-bbox="195 824 408 873">Engine Oil Level Stop Switch Off Vehicle</p>	<p data-bbox="526 731 844 754">* The engine oil level is too low.</p> <div data-bbox="550 772 1696 859" style="border: 1px solid gray; padding: 5px;"> <p data-bbox="559 783 1273 808">! NOTE Engine damage caused by driving with insufficient engine oil</p> <p data-bbox="559 824 1068 849">► Avoid long journeys with insufficient engine oil.</p> </div>

Display messages	Possible causes/consequences and ► Solutions
	<ul style="list-style-type: none"> ► Stop the vehicle immediately in accordance with the traffic conditions. Do not continue driving. ► Switch off the engine. ► Add 1.1 US qt (1 l) of engine oil (→ page 340). ► Check the engine oil level. <p>Notes on engine oil (→ page 497).</p>
 <p>Engine Oil Pressure Stop Switch Off Vehicle</p>	<p>* The oil pressure is too low.</p> <div style="border: 1px solid black; padding: 5px; margin: 5px 0;"> <p>! NOTE Engine damage caused by driving with insufficient oil pressure</p> <ul style="list-style-type: none"> ► Avoid driving with insufficient oil pressure. </div> <ul style="list-style-type: none"> ► Stop the vehicle immediately in accordance with the traffic conditions. Do not continue driving. ► Switch off the engine. ► Consult a qualified specialist workshop.
 <p>Engine Oil Level Cannot Be Measured</p>	<p>* The electrical connection to the oil level sensor has been interrupted or the oil level sensor is faulty.</p> <ul style="list-style-type: none"> ► Consult a qualified specialist workshop.

Warning and indicator lamps

Overview of indicator and warning lamps

Some systems will perform a self-test when the ignition is switched on. Some indicator and warning lamps may briefly light up or flash. This behavior is non-critical. These indicator and warning lamps indicate a malfunction only if they light up or flash after the engine has been started or during a journey.



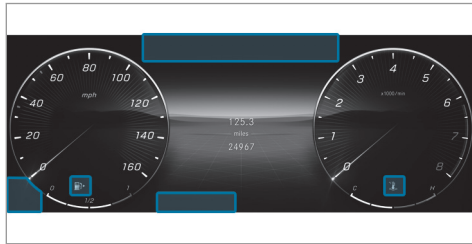

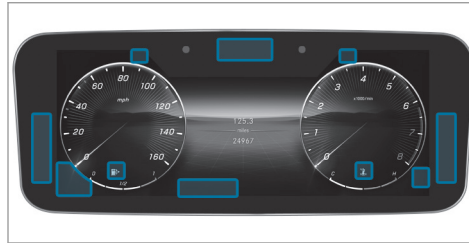

Driver display



Driver display with driver camera



Indicator and warning lamps:

-  Restraint system (→ page 562)
-  Seat belt (→ page 562)
-  Power steering (yellow) (→ page 564)
-  Power steering (red) (→ page 564)
-  Rear axle steering (yellow) (→ page 564)
-  Rear axle steering (red) (→ page 564)
-  Coolant temperature (→ page 566)



Engine diagnostics (→ page 566)



Electrical malfunction (→ page 566)



Reserve fuel with fuel filler flap location indicator (→ page 566)



USA: electric parking brake (red) (→ page 570)



Canada: electric parking brake (red) (→ page 570)



Electric parking brake (yellow) (→ page 570)



USA: Recuperative Brake System (→ page 570)



Canada: brakes (yellow) (→ page 570)



USA: brakes (red) (→ page 570)



Canada: brakes (red) (→ page 570)



Distance warning (→ page 573)



AIRMATIC/E-ACTIVE BODY CONTROL (→ page 573)











ABS (→ page 574)





ESP® (→ page 574)

562 Display messages and warning/indicator lamps



	ESP® OFF (→ page 574)
	Mercedes-Benz emergency call system (→ page 577)
	Tire pressure monitoring system (→ page 577)
	Parking lights (→ page 155)
	Low beam (→ page 155)
	High beam (→ page 156)
	Turn signal light (→ page 156)
	Rear fog light (→ page 155)



Occupant safety

Warning/indicator lamp	Possible causes/consequences and ► Solutions
 Restraint system warning lamp	<p>* The red restraint system warning lamp is lit while the engine is running. The restraint system is malfunctioning (→ page 43).</p> <p>▲ WARNING Risk of injury due to malfunctions in the restraint system</p> <p>Components in the restraint system may be activated unintentionally or not deploy as planned in an accident.</p> <p>► Have the restraint system checked and repaired immediately at a qualified specialist workshop.</p> <p>► Drive on carefully.</p>

Warning/indicator lamp	Possible causes/consequences and ► Solutions
	<ul style="list-style-type: none"> ► Comply with the messages on the driver display. ► Consult a qualified specialist workshop immediately.
 <p data-bbox="195 417 426 467">Seat belt warning lamp flashes</p>	<p data-bbox="513 327 1471 377">* The red seat belt warning lamp flashes and an intermittent warning tone sounds. The driver or front passenger has not fastened his/her seat belt while the vehicle is in motion.</p> <ul style="list-style-type: none"> ► Fasten your seat belt (→ page 48). There are objects on the front passenger seat. ► Remove the objects from the front passenger seat.
 <p data-bbox="195 578 426 627">Seat belt warning lamp lights up</p>	<p data-bbox="513 487 1493 570">* The red seat belt warning lamp lights up for six seconds once the engine has started. In addition, an intermittent warning tone may sound. The red seat belt warning lamp reminds the driver and front passenger to fasten their seat belts.</p> <ul style="list-style-type: none"> ► Fasten your seat belt (→ page 48). <p data-bbox="528 624 1544 650">If you have placed objects on the front passenger seat, the red seat belt warning lamp may remain lit.</p>

Vehicle

Warning/indicator lamp	Possible causes/consequences and ► Solutions
 <p data-bbox="144 381 384 433">Power steering warning lamp (yellow)</p>	<p data-bbox="463 291 1212 339">* The yellow power steering warning lamp is lit when the engine is running. The power assistance or the steering itself is malfunctioning.</p> <ul style="list-style-type: none"> <li data-bbox="476 350 920 373">► Note the messages on the driver display.
 <p data-bbox="144 543 384 595">Power steering warning lamp (red)</p>	<p data-bbox="463 453 1179 502">* The red power steering warning lamp is lit while the engine is running. The power assistance or the steering itself is malfunctioning.</p> <div data-bbox="482 519 1646 698" style="border: 1px solid gray; padding: 5px;"> <p data-bbox="491 526 1138 550">▲ WARNING Risk of accident if steering capability is impaired</p> <p data-bbox="495 567 1397 591">If the steering does not function as intended, the vehicle's operating safety is jeopardized.</p> <ul style="list-style-type: none"> <li data-bbox="495 601 1604 653">► Pull over and stop the vehicle safely as soon as possible, paying attention to road and traffic conditions. Do not continue driving under any circumstances. <li data-bbox="495 664 929 687">► Consult a qualified specialist workshop. </div> <ul style="list-style-type: none"> <li data-bbox="476 715 920 739">► Note the messages on the driver display.

Warning/indicator lamp	Possible causes/consequences and ► Solutions
 <p>Rear axle steering warning lamp (yellow)</p>	<p>* The yellow rear axle steering warning lamp is lit while the engine is running. The rear axle steering is malfunctioning.</p> <ul style="list-style-type: none"> ► Note the messages on the driver display.
 <p>Rear axle steering warning lamp (red)</p>	<p>* The red rear axle steering warning lamp is lit while the engine is running. The rear axle steering is malfunctioning.</p> <div style="border: 1px solid gray; padding: 5px; margin-top: 10px;"> <p>⚠ WARNING Risk of accident if steering capability is impaired</p> <p>If the steering does not function as intended, the vehicle's operating safety is jeopardized.</p> <ul style="list-style-type: none"> ► Pull over and stop the vehicle safely as soon as possible, paying attention to road and traffic conditions. Do not continue driving under any circumstances. ► Consult a qualified specialist workshop. </div> <ul style="list-style-type: none"> ► Note the messages on the driver display.

Engine

Warning/indicator lamp



Coolant warning lamp (red)

Possible causes/consequences and ► Solutions

* The red coolant warning lamp is lit while the engine is running.

Possible causes:

- The temperature sensor is malfunctioning
- The coolant level is too low
- The air supply to the radiator is obstructed
- The radiator fan is faulty
- The engine coolant pump is faulty



If there is an additional warning tone, the coolant temperature has exceeded the maximum permissible temperature.

▲ WARNING Risk of burns when opening the hood

If you open the hood when the engine has overheated or when there is a fire in the engine compartment, the following situations may occur:

- You could come into contact with hot gases.
- You could come into contact with other hot, escaping operating fluids.
- Before opening the hood, allow the overheated engine to cool down.
- In the event of a fire in the engine compartment, keep the hood closed and call the fire service.

Warning/indicator lamp	Possible causes/consequences and ► Solutions
	<ul style="list-style-type: none"> ► Stop the vehicle immediately in accordance with the traffic conditions and switch off the engine. Do not continue driving under any circumstances. ► Note the messages on the driver display. <p>If the coolant temperature display is at the lower end of the temperature scale:</p> <ul style="list-style-type: none"> ► Consult a qualified specialist workshop. <p>If the coolant temperature display is at the upper end of the temperature scale:</p> <ul style="list-style-type: none"> ► Exit the vehicle and keep a safe distance from it until the engine has cooled down. ► Make sure that the air supply to the radiator is not obstructed. ► Avoiding high loads on the engine, drive to the nearest qualified specialist workshop. In doing so, ensure that the coolant temperature display remains below the red area.
<div style="border: 1px solid black; padding: 5px; display: inline-block;">  </div> <p>Coolant warning lamp (yellow)</p>	<p>* The yellow coolant warning lamp is lit while the engine is running.</p> <p>Possible causes:</p> <ul style="list-style-type: none"> • The temperature sensor is malfunctioning • The charge air, transmission oil or battery cooling is faulty • The radiator shutters are blocked or defective <ul style="list-style-type: none"> ► Avoiding high loads on the engine, drive to the nearest qualified specialist workshop.

Warning/indicator lamp	Possible causes/consequences and ► Solutions
 <p data-bbox="144 342 402 391">Engine diagnosis warning lamp</p>	<p data-bbox="463 249 1609 394">* The yellow Check Engine warning lamp is lit while the engine is running. A malfunction has occurred in the engine, the exhaust system or the fuel system. The emission limit values may be exceeded and the engine may be in emergency mode. In some states, legal requirements stipulate that you must immediately consult a qualified specialist workshop as soon as the yellow Check Engine warning lamp lights up.</p> <p data-bbox="476 405 1313 430">► Have the vehicle checked as soon as possible at a qualified specialist workshop.</p>
 <p data-bbox="144 539 426 588">Electrical malfunction warning lamp</p>	<p data-bbox="463 449 898 496">* The red electrical fault warning lamp is lit. There is a fault in the electrics.</p> <p data-bbox="476 506 935 532">► Note the messages on the driver's display.</p>
 <p data-bbox="144 698 408 746">Fuel reserve warning lamp flashes</p>	<p data-bbox="463 608 1628 680">* The yellow fuel reserve warning lamp lights up while you are driving. There has been pressure loss in the fuel system. The fuel filler cap is not closed correctly or the fuel system is leaking.</p> <p data-bbox="476 691 750 716">► Close the fuel filler cap.</p> <p data-bbox="476 742 1014 768">If the fuel filler cap has already been closed correctly:</p> <p data-bbox="476 779 907 804">► Consult a qualified specialist workshop.</p>



Warning/indicator lamp



Fuel reserve warning lamp
lights up

Possible causes/consequences and ► Solutions

- * The yellow fuel reserve warning lamp lights up while the engine is running.
The fuel supply has dropped into the reserve range.
 - Refuel.



Brakes

Warning/indicator lamp	Possible causes/consequences and ► Solutions
 <p>Electric parking brake indicator lamp (red) (USA only)</p>  <p>Electric parking brake indicator lamp (red) (Canada only)</p>  <p>The electric parking brake (yellow) indicator lamp</p>	<p>* The red electric parking brake indicator lamp flashes or is lit. The yellow electric parking brake indicator lamp is also lit in the event of a malfunction.</p> <ul style="list-style-type: none">► Note the messages on the driver display.

Warning/indicator lamp	Possible causes/consequences and ► Solutions
<div data-bbox="205 254 362 334">  </div> <p data-bbox="195 342 473 394">Recuperative Brake System warning lamp (USA only)</p> <div data-bbox="205 401 362 481">  </div> <p data-bbox="195 490 454 541">Brakes warning lamp (yellow) (Canada only)</p>	<p data-bbox="519 251 1637 303">*The yellow RBS warning lamp (USA only) or the yellow (P) brakes warning lamp (Canada only) is lit while the engine is running.</p> <div data-bbox="532 322 1696 472" style="background-color: #f0f0f0; padding: 5px;"> <p data-bbox="541 327 1245 353">▲ WARNING Risk of an accident due to a brake system malfunction</p> <p data-bbox="541 368 1332 394">If the brake system is malfunctioning, braking characteristics may be impaired.</p> <ul style="list-style-type: none"> <li data-bbox="541 405 763 430">▶ Drive on carefully. <li data-bbox="541 441 1369 467">▶ Have the brake system checked immediately at a qualified specialist workshop. </div> <p data-bbox="528 490 957 515">The hill start assist may be malfunctioning.</p> <ul style="list-style-type: none"> <li data-bbox="528 526 1465 552">▶ Adjust your speed and drive on carefully, leaving a suitable distance to the vehicle in front. <li data-bbox="528 562 1147 588">▶ If the driver's display shows a display message, observe it. <li data-bbox="528 598 962 624">▶ Consult a qualified specialist workshop.

Warning/indicator lamp	Possible causes/consequences and ► Solutions
<div data-bbox="155 252 312 335" data-label="Image"> </div> <p data-bbox="144 342 402 391">Brake warning lamp (USA only)</p> <div data-bbox="155 397 312 480" data-label="Image"> </div> <p data-bbox="144 487 421 536">Brake system warning lamp (Canada only)</p>	<p data-bbox="463 249 1166 273">* The red brake system warning lamp is lit while the engine is running.</p> <p data-bbox="476 283 643 307">Possible causes:</p> <ul data-bbox="482 318 1430 373" style="list-style-type: none"> <li data-bbox="482 318 1430 341">• The brake force boosting is malfunctioning and the braking characteristics may be affected. <li data-bbox="482 350 1097 373">• There is insufficient brake fluid in the brake fluid reservoir. <p data-bbox="476 394 938 418">► Note the messages on the driver's display.</p> <div data-bbox="482 439 1646 477" data-label="Section-Header"> <p>▲ WARNING Risk of accident and injury if brake force boosting is malfunctioning</p> </div> <p data-bbox="495 484 1622 536">If brake force boosting is malfunctioning, increased brake pedal force may be necessary for braking. The braking characteristics may be impaired. The braking distance can increase in emergency braking situations.</p> <ul data-bbox="495 547 1134 602" style="list-style-type: none"> <li data-bbox="495 547 1134 570">► Stop in a safe location immediately. Do not continue driving. <li data-bbox="495 581 931 602">► Consult a qualified specialist workshop. <div data-bbox="482 636 1646 674" data-label="Section-Header"> <p>▲ WARNING Risk of an accident due to low brake fluid level</p> </div> <p data-bbox="495 681 1498 705">If the brake fluid level is too low, the braking effect and the braking characteristics may be impaired.</p> <ul data-bbox="495 715 1604 832" style="list-style-type: none"> <li data-bbox="495 715 1604 767">► Pull over and stop the vehicle safely as soon as possible, paying attention to road and traffic conditions. Do not continue driving under any circumstances. <li data-bbox="495 778 931 801">► Consult a qualified specialist workshop. <li data-bbox="495 812 765 832">► Do not add brake fluid.

Driving systems



Warning/indicator lamp	Possible causes/consequences and ► Solutions
 <p data-bbox="195 384 463 433">Warning lamp for distance warning function</p>	<p data-bbox="513 291 1230 339">* The red distance warning lamp lights up while the vehicle is in motion. The distance to the vehicle in front is too small for the speed selected.</p> <p data-bbox="524 350 1434 376">If there is an additional warning tone, you are approaching an obstacle at too high a speed.</p> <ul style="list-style-type: none"> <li data-bbox="524 386 907 412">► Be prepared to brake immediately. <li data-bbox="524 417 787 443">► Increase the distance. <p data-bbox="524 464 994 490">Function of Active Brake Assist (→ page 239).</p>
 <p data-bbox="195 596 473 645">Active Brake Assist warning lamp</p>	<p data-bbox="513 503 1027 552">* The Active Brake Assist yellow warning lamp is lit. The system is restricted or unavailable.</p> <ul style="list-style-type: none"> <li data-bbox="524 562 972 588">► Note the messages on the driver display.
 <p data-bbox="195 757 454 806">Suspension warning lamp (yellow)</p>	<p data-bbox="513 664 1215 712">* The yellow AIRMATIC/E-ACTIVE BODY CONTROL warning lamp is lit. A malfunction has occurred in AIRMATIC/E-ACTIVE BODY CONTROL.</p> <ul style="list-style-type: none"> <li data-bbox="524 723 972 749">► Note the messages on the driver display.

574 Display messages and warning/indicator lamps

Warning/indicator lamp	Possible causes/consequences and ► Solutions
 <p data-bbox="144 339 408 391">Suspension warning lamp (red)</p>	<p data-bbox="463 249 1166 298">* The red AIRMATIC/E-ACTIVE BODY CONTROL warning lamp is lit. A malfunction has occurred in AIRMATIC/E-ACTIVE BODY CONTROL.</p> <div data-bbox="482 319 1646 405" style="border: 1px solid black; padding: 5px;"><p data-bbox="491 329 1276 353">! NOTE The vehicle's driving characteristics will have changed significantly.</p><p data-bbox="491 368 925 392">► Consult a qualified specialist workshop.</p></div> <p data-bbox="476 420 925 477">► Note the messages on the driver display. ► Consult a qualified specialist workshop.</p>

Driving safety systems

Warning/indicator lamp	Possible causes/consequences and ► Solutions
 <p data-bbox="144 715 328 739">ABS warning lamp</p>	<p data-bbox="463 625 1101 674">* The yellow ABS warning lamp is lit while the engine is running. ABS is malfunctioning.</p> <p data-bbox="476 684 1079 708">If an additional warning tone sounds, EBD is malfunctioning.</p> <p data-bbox="476 718 1252 742">Other driving systems and driving safety systems may also be malfunctioning.</p> <p data-bbox="476 753 925 777">► Note the messages on the driver display.</p> <div data-bbox="482 795 1646 871" style="border: 1px solid black; padding: 5px;"><p data-bbox="491 806 1230 829">! WARNING There is a risk of skidding if EBD or ABS is malfunctioning</p><p data-bbox="491 845 861 869">The wheels may lock during braking.</p></div>

Warning/indicator lamp	Possible causes/consequences and ► Solutions
	<p>The steerability and braking characteristics are heavily impaired and the braking distance may increase. In addition, other driving safety systems are switched off.</p> <ul style="list-style-type: none"> ► Drive on carefully. ► Have the brake system checked immediately at a qualified specialist workshop.
 <p>ESP® warning lamp flashes</p>	<p>* The yellow ESP® warning lamp flashes while the vehicle is in motion. One or more wheels have reached their grip limit (→ page 221).</p> <ul style="list-style-type: none"> ► Adapt your driving style to suit the road and weather conditions.
 <p>ESP® warning lamp lights up</p>	<p>* The yellow ESP® warning lamp is lit while the engine is running. ESP® is malfunctioning. Other driving systems and driving safety systems (e.g. BAS) may also be malfunctioning.</p> <ul style="list-style-type: none"> ► Note the messages on the driver display. <div style="background-color: #e0e0e0; padding: 5px; border: 1px solid #ccc;"> <p>▲ WARNING Risk of skidding if ESP® is malfunctioning</p> </div> <p>If ESP® is malfunctioning, ESP® cannot carry out vehicle stabilization. In addition, other driving safety systems are switched off.</p> <ul style="list-style-type: none"> ► Drive on carefully. ► Have ESP® checked at a qualified specialist workshop.

Warning/indicator lamp



ESP® OFF warning lamp

Possible causes/consequences and ► Solutions

* The yellow ESP® OFF warning lamp is lit while the engine is running. ESP® is deactivated.
Other driving systems and driving safety systems may also be inoperative.

▲ WARNING Risk of skidding when driving with ESP® deactivated

ESP® does not act to stabilize the vehicle. The availability of further driving safety systems is also limited.

- Drive on carefully.
- Deactivate ESP® only for as long as the situation requires.

If ESP® cannot be activated, ESP® is malfunctioning.

- Have ESP® checked immediately at a qualified specialist workshop.

- Observe the notes on deactivating ESP® (→ page 221).

Mercedes-Benz emergency call system

Warning/indicator lamp	Possible causes/consequences and ► Solutions
 <p>Mercedes-Benz emergency call system warning lamp</p>	<p>*The Mercedes-Benz emergency call system is malfunctioning. The Mercedes me connect system is also malfunctioning.</p> <p>► Consult a qualified specialist workshop.</p>

Tire pressure monitor

Warning/indicator lamp	Possible causes/consequences and ► Solutions
 <p>Tire pressure monitoring system warning lamp flashes</p>	<p>*The yellow tire pressure monitor warning lamp (pressure loss/malfunction) flashes for approximately one minute and then remains lit. The tire pressure monitor is malfunctioning.</p> <p>▲ WARNING There is a risk of an accident if the tire pressure monitoring system is malfunctioning</p> <p>The tire pressure monitoring system cannot issue a warning if there is pressure loss in one or more of the tires. Tires with insufficient tire pressure may impair the driving characteristics as well as steering and braking.</p> <p>► Have the tire pressure monitoring system checked at a qualified specialist workshop.</p>

Warning/indicator lamp



Tire pressure monitoring system warning lamp lights up

Possible causes/consequences and ► Solutions

* The yellow tire pressure monitoring system warning lamp (pressure loss/malfunction) is lit.
The tire pressure monitoring system has detected tire pressure loss in at least one of the tires.

▲ WARNING Risk of an accident due to insufficient tire pressure

- The tires can burst.
- The tires can wear excessively and/or unevenly.
- The driving characteristics as well as the steering and braking may be greatly impaired.

You could then lose control of the vehicle.

- Observe the recommended tire pressures.
- Adjust the tire pressure if necessary.

- Stop the vehicle in accordance with the traffic conditions.
- Check the tire pressure and the tires.

1, 2, 3 ...

- 3D driver display**
 - Function/notes..... 280
- 3D instrument cluster**
 - see 3D driver display
- 4MATIC**
 - Function..... 207
- 12 V battery**
 - see Battery (vehicle)
- 48 V on-board electrical system**
 - see EQ Boost technology
- 115 V socket**
 - see Socket (115 V)

A

- A/C function**
 - Activating/deactivating (control panel)..... 178
 - Activating/deactivating (MBUX multimedia system)..... 179
- ABS (Anti-lock Braking System)..... 220**
- Acceleration**
 - see Kickdown

Accident and Breakdown Management

- Mercedes me connect..... 320

Acoustic locking verification signal

- Activating/deactivating..... 77

Activating a commuter route..... 310**Active Blind Spot Assist**

- Activating/deactivating..... 254
- Brake application..... 252
- Function..... 250
- System limitations..... 250

Active Brake Assist

- Function/notes..... 239
- Setting..... 244

Active Distance Assist DISTRONIC

- Active Emergency Stop Assist..... 235
- Active Lane Change Assist..... 237
- Calling up a speed..... 228
- Function..... 226
- Increasing/decreasing the speed..... 228
- Route-based speed adaptation..... 231
- Storing a speed..... 228
- Switching off/deactivating..... 228
- Switching on/activating..... 228

- System limitations..... 226

Active Emergency Stop Assist..... 235**Active headlamps..... 158****Active Lane Change Assist**

- Activating/deactivating..... 239
- Function..... 237

Active Lane Keeping Assist

- Activating/deactivating..... 256
- Activating/deactivating the warning..... 256
- Function..... 254
- Setting the sensitivity..... 256
- System limits..... 254

Active Parking Assist

- Automatic braking function..... 276
- Cross traffic warning..... 277
- Drive Away Assist..... 277
- Exiting a parking space..... 275
- Function..... 271
- Maneuvering brake function..... 278
- Parking..... 273
- Pausing..... 276
- System limitations..... 271

Active Service System PLUS

- see ASSYST PLUS

- Active Speed Limit Assist**
 Display..... 230
 Function..... 230
- Active Steering Assist**
 Activating/deactivating..... 235
 Active Emergency Stop Assist..... 235
 Active Lane Change Assist..... 237
 Function..... 233
 System limits..... 233
- Active Traffic Jam Assist**
 Function..... 233
- Adaptive cruise control**
 see Active Distance Assist DISTRONIC
- Adaptive Highbeam Assist**
 Function..... 161
 Switching on/off..... 162
- Adaptive Highbeam Assist Plus**
 Activating/deactivating..... 164
 Function..... 163
- Additives**
 Engine oil..... 497
 Fuel..... 496
- Additives (engine oil)**
 see Additives
- Additives (fuel)**
 see Fuel
- ADS PLUS damping system**
 see AIRMATIC
- After-sales service center**
 see ASSYST PLUS
- Air bag**
 Reduced protection..... 52
- Air conditioning menu**
 Calling up..... 178
- Air distribution**
 Setting..... 176
 Setting (MBUX multimedia system)..... 179
- Air freshener system**
 see Perfume atomizer
- Air inlet**
 see Air-water duct
- Air pressure**
 see Tire pressure
- Air suspension**
 see AIRMATIC
- Air vents**
 Adjusting (front)..... 186
 Adjusting (rear)..... 187
 Glove box..... 188
- Air vents**
 see Air vents
- Air-conditioning system**
 see Climate control
- Air-recirculation mode**..... 181
- Air-water duct**
 Keeping free..... 343
- Airbag**
 Activation..... 43
 Belt airbag..... 47
 Cushionbag..... 49
 Front airbag (driver, front passenger)..... 49
 Installation locations..... 49
 Knee airbag..... 49
 Overview..... 49
 PASSENGER AIR BAG indicator lamp..... 55
 Protection..... 51
 Rear airbag..... 49
 REAR SEAT AIR BAG indicator lamps..... 59
 Side airbag..... 49
 Window curtain airbag..... 49

- Airflow**
Setting..... 176
- AIRMATIC**
Setting..... 257
Suspension..... 256
- Alarm**
see Panic alarm
- Alarm system**
see ATA (anti-theft alarm system)
- All-wheel drive**
see 4MATIC
- Alternative route**
see Route
- Ambient lighting**
Setting (MBUX multimedia system)..... 166
- Android Auto**
see Smartphone integration
- Animals**
Pets in the vehicle..... 75
- Anti-lock braking system**
see ABS (Anti-lock Braking System)
- Anti-skid chains**
see Snow chains
- Anti-theft protection**
Immobilizer..... 103
- Anti-theft protection**
see ATA (anti-theft alarm system)
- Anticipatory occupant protection**
see PRE-SAFE® (anticipatory occupant protection)
see PRE-SAFE® PLUS (anticipatory occupant protection plus)
- Apple CarPlay®**
see Smartphone integration
- Assistance systems**
see Driving safety system
- ASSYST PLUS**
Battery disconnection periods..... 338
Displaying the service due date..... 337
Function/notes..... 337
Regular maintenance work..... 337
Special service requirements..... 337
- ATA (anti-theft alarm system)**
Activating/deactivating the interior motion sensor..... 105
Arming/disarming the tow-away alarm..... 104
Deactivating the alarm..... 104
Function..... 103
Function of the interior motion sensor.. 104
The tow-away alarm function..... 104
- ATTENTION ASSIST**
System limits..... 224
- ATTENTION ASSIST with microsleeep detection**
Function..... 224
- Attention assistant**
see ATTENTION ASSIST with microsleeep detection
- Augmented reality**
Function on the Head-up Display..... 282
- Authorized Mercedes-Benz Center**
see Qualified specialist workshop
- Authorized workshop**
see Qualified specialist workshop
- Automatic co-driver airbag shutoff**
Function of co-driver airbag shutoff..... 53
- Automatic distance control**
see Active Distance Assist DISTRONIC
- Automatic driving lights**..... 156

- Automatic engine start (ECO start/stop function)**..... 198
- Automatic engine stop (ECO start/stop function)**..... 198
- Automatic front passenger front air-bag shutoff**
PASSENGER AIR BAG indicator lamp..... 55
- Automatic lateral support adjustment**
Setting..... 123
- Automatic measures after an accident**.... 61
- Automatic mirror folding function**
Activating/deactivating..... 174
- Automatic seat adjustment**
Setting..... 122
- Automatic transmission**
DIRECT SELECT lever..... 203
Drive program display..... 202
Drive programs..... 201
DYNAMIC SELECT button..... 201
Engaging drive position..... 205
Engaging reverse gear..... 204
Kickdown..... 207
Manual gearshifting..... 206
- Selecting park position..... 205
Steering wheel paddle shifters..... 206
Transmission position display..... 203
Transmission positions..... 203
- B**
- Bad weather light**..... 159
- Bag hook**..... 141
- BAS (Brake Assist System)**..... 220
- Battery (SmartKey)**
Replacing..... 78
- Battery (vehicle)**
Charging..... 361
Charging (Remote Online)..... 191
Notes..... 357
Notes (starting assistance and charging)..... 359
Replacing..... 362
Starting assistance..... 361
- Belt**
see Seat belt
- Belt airbag**
Activation..... 43
- Function/notes..... 47
- Blind**
see Roller sunblind
- Blower**
see Climate control
- Brake Assist System**
see BAS (Brake Assist System)
- Brake fluid**
Notes..... 498
- Brake force distribution**
EBD (electronic brake force distribution)..... 222
- Brakes**
ABS (Anti-lock Braking System)..... 220
Active Brake Assist..... 239
BAS (Brake Assist System)..... 220
Breaking-in notes..... 192
Driving tips..... 194
EBD (electronic brake force distribution)..... 222
HOLD function..... 223
Limited braking effect (salt-treated roads)..... 194

- New/replaced brake linings/brake discs..... 192
 Post-collision brake..... 61
- Braking assistance**
 see BAS (Brake Assist System)
- Breakdown**
 Assistance overview..... 22
 Changing a wheel..... 396
 Roadside Assistance..... 28
 Tow-starting..... 368
 Towing away..... 364
 Transporting the vehicle..... 365
- Breakdown**
 see Flat tire
- Breaking-in notes**..... 192
- C**
- Calls**
 Mercedes me..... 321
- Camera**
 Information..... 218
- Camera**
 see Dashcam
- see Driver camera
 see Rear view camera
 see Surround view camera
- Car key**
 see SmartKey
- Car wash**
 see Care
- Car wash (care)**..... 343
- Car-to-X-Communication**
 Displaying hazard warnings..... 313
- Care**
 Air-water duct..... 343
 Automatic car wash..... 343
 Carpet..... 348
 Decorative foil..... 345
 Display..... 348
 EASY-PACK trunk box..... 348
 Exterior lighting..... 346
 Head-up Display..... 348
 Headliner..... 348
 Paintwork..... 345
 Plastic trim..... 348
 Power washer..... 344
 Real wood/trim elements..... 348
- Rear view camera..... 346
 Seat belt..... 348
 Seat cover..... 348
 Sensors..... 346
 Steering wheel..... 348
 Surround view camera..... 346
 Tailpipes..... 346
 Washing by hand..... 345
 Wheels/rims..... 346
 Windows..... 346
 Wiper blades..... 346
- Carpet (Care)**..... 348
- Change of address**..... 28
- Change of ownership**..... 28
- Changing a wheel**
 Preparation..... 396
 Raising the vehicle..... 396
- Changing a wheel**
 see Emergency spare wheel
- Changing gears**
 Manually..... 206
- Changing hub caps**..... 396

Charging

Battery (vehicle).....	361
Mobile phone (wireless).....	151
USB port.....	148

Chauffeur mode

Information.....	114
Moving the front passenger seat into the chauffeur position.....	115
Moving the front passenger seat into the normal position.....	117

Child safety lock

Rear doors.....	73
Rear side windows.....	75

Child seat

Attaching (notes).....	66
Basic instructions.....	62
Front-passenger seat (notes).....	72
LATCH-type (ISOFIX) (installing).....	67
Notes on risks and dangers.....	63
Rear airbag.....	70
Securing on the front passenger seat.....	72
Securing on the rear seat.....	71
Top Tether.....	69

Children

Avoiding dangers in the vehicle.....	63
Basic instructions.....	62
Special seat belt retractor.....	66

Chock

Storage location.....	395
-----------------------	-----

Chock

see Chock

City lighting..... 159**Cleaning**

















see Care





































Climate control

















Activating/deactivating.....	178
Activating/deactivating (rear operating unit).....	178
Activating/deactivating the A/C function (control panel).....	178
Activating/deactivating the A/C function (MBUX multimedia system).....	179
Activating/deactivating the synchronization function (MBUX multimedia system).....	180
Air-recirculation mode.....	181
Automatic control.....	179

Calling up the air conditioning menu.....	178
Control panel for 3-zone automatic climate control.....	176
Defrost.....	179
Defrosting the windshield.....	176
Filling capacity for PAG oil.....	501
Front air vents.....	186
Glove box air vent.....	188
Immediate pre-entry climate control.....	185
Information on the windshield heater....	183
Inserting/removing the flacon (fragrance system).....	182
Ionization.....	181
Note.....	176
Pre-entry climate control at departure time.....	183
Rear air vents.....	187
Rear operating unit.....	177
Refrigerant.....	500
Refrigerant filling capacity.....	501
Removing condensation from the windows.....	180
Residual heat.....	181
Residual heat (rear operating unit).....	181
Setting (MBUX multimedia system).....	178
Setting the air distribution.....	176

- Setting the airflow..... 176
 Setting the fragrance system..... 181
 Setting the temperature..... 176
 Switching the rear window heater
 on/off..... 176
 Ventilating the vehicle (convenience
 opening)..... 94
- Co-driver airbag shutoff**
 see Automatic co-driver airbag shutoff
- Cockpit**
 Overview..... 6
- Coffee cup symbol**
 see ATTENTION ASSIST with micro-
 sleep detection
- Collision detection (parked vehicle)**
 Information..... 216
- Combination switch**..... 156
- Content sharing menu**
 Overview..... 288
- Control elements**
 Touch-sensitive..... 27
- Convenience closing**..... 94
- Convenience opening**..... 94
- Coolant (engine)**
 Capacity..... 499
 Level check..... 342
 Notes..... 499
- Cooling**
 see Climate control
- Copyrights**
 License..... 40
 Trademarks..... 40
- Cornering light**..... 158
- Crosswind Assist**
 Function/notes..... 222
- Cup holder**
 Switching the cooling/heating func-
 tion on/off..... 145
- Cushionbag**..... 49
- Customer Assistance Center (CAC)**..... 34
- Customer Relations Department**..... 34
- D**
- Dashboard**
 see Cockpit
- Dashcam**
 Notes..... 315
 Selecting a USB device..... 315
 Starting/stopping video recording..... 315
- Data acquisition**
 Vehicle..... 36
- Data protection rights**
 Data storage..... 39
- Data storage**
 Data protection rights..... 39
 Electronic control units..... 36
 Online services..... 38
 Vehicle..... 36
- Daytime running lamp mode**
 see Daytime running lamps
- Daytime running lamps**
 Activating/deactivating..... 164
- Deactivating the alarm (ATA)**..... 104
- Dealership**
 see Qualified specialist workshop
- Declaration of conformity**
 Wireless vehicle components..... 30
- Decorative foil (cleaning instructions)**.... 345

- Definitions (tires and loading)**..... 389
- Defrost function**..... 179
- Destination entry**
 Entering a POI or address..... 309
- Diagnostics connection**..... 32
- Diesel**
 Low outside temperatures..... 496
 Notes..... 496
- DIGITAL LIGHT**
 Active headlamps..... 158
 Assistance functions..... 160
 Bad weather light..... 159
 City lighting..... 159
 Cornering light..... 158
 Fog light (enhanced)..... 159
 Highway mode..... 159
 Intelligent Light System..... 158
 Switching the Intelligent Light System on/off..... 161
 Topographical compensation..... 159
- Digital Operator's Manual**..... 24
- Dinghy towing**
 see Tow-bar system
- DIRECT SELECT lever**
 Engaging drive position..... 205
 Engaging neutral..... 204
 Engaging park position automatically.... 205
 Engaging reverse gear..... 204
 Function..... 203
 Selecting park position..... 205
- Display (care)**..... 348
- Display (driver display)**
 Messages in the driver display..... 286
- Display (MBUX multimedia system)**
 Home screen..... 288
 Operating..... 289
 Settings..... 285
- Display message**
 Calling up (driver display)..... 503
 Notes..... 503
- Display messages**
 --- mph..... 533
 12 V On-board Electrical System Service Required..... 552
 48 V Battery See Operator's Manual..... 554
-  Active Headlamps Inoperative..... 510
-  ATTENTION ASSIST Inoperative.... 533
-  ATTENTION ASSIST Nodding
 Off Take a Break!..... 533
-  ATTENTION ASSIST: Take a Break!..... 533
-  Automatic Headlamp Mode Inoperative..... 510
-  Beginning Emergency Stop..... 536
-  BRAKE Brake Immediately..... 531
-  BRAKE Check Brake Fluid Level..... 532
-  Check Coolant Level See Operator's Manual..... 520
-  Check Engine Oil Level (Add 1 quart)..... 559
-  Check Left Low Beam (example)..... 509
-  Check Tires..... 556
-  Check Washer Fluid..... 519
-  Compressor Is Cooling..... 546

- | | | |
|--|--|--|
|  Coolant Stop Switch Off Vehicle... 521 |  Inoperative See Operator's Manual..... 549 |  Obtain a New Key..... 507 |
|  Currently Unavailable See Operator's Manual..... 547 |  EBD Inoperative See Operator's Manual..... 550 |  Off..... 534 |
|  Currently Unavailable See Operator's Manual..... 549 |  SOS Inoperative..... 552 |  HOLD Off..... 532 |
|  Don't Forget Your Key..... 508 |  Intensive Cleaning Activated for 30 Seconds..... 519 |  PARK Parking Brake See Operator's Manual..... 527 |
|  Engine Oil Level Cannot Be Measured..... 560 |  Key Being Initialized Please Wait.. 509 |  Please Correct Tire Pressure..... 557 |
|  Engine Oil Level Reduce Oil Level..... 559 |  Key Not Detected (red display message)..... 508 |  PARK Please Release Parking Brake..... 530 |
|  Engine Oil Level Stop Switch Off Vehicle..... 559 |  Key Not Detected (white display message)..... 508 |  Please Wait Charging 48 V Battery..... 554 |
|  Engine Oil Pressure Stop Switch Off Vehicle..... 560 |  Left Window Airbag Malfunction Service Required (example)..... 504 |  Rear Axle Steering Currently Malfunctioning..... 516 |
|  Front Left Malfunction Service Required (example)..... 504 |  Malfunction Drive at Max. 50 mph..... 542, 543 |  Rear Axle Steering Malfunction Service Required..... 516 |
|  Fuel Filler Cap Open..... 522 |  Malfunction See Operator's Manual..... 510 |  Rear Axle Steering Malfunction Stop Immediately..... 517 |
|  Fuel Level Low..... 522 |  Malfunction Stop..... 544 |  Replace Key Battery..... 507 |
|  Inoperative See Operator's Manual..... 548 |  Maximum Speed 12mph..... 545 |  Restraint System Malfunction Service Required..... 504 |
| | |  Steering Malfunction Drive Carefully Service Required..... 515 |

-  Steering Malfunction Increased
Physical Effort See Operator's Manual... 515
-  Steering Malfunction Stop
Immediately See Operator's Manual..... 515
-  STOP Vehicle Level Too Low..... 545
-  Stop Vehicle See Operator's
Manual..... 552, 554
-  Stop vehicle To charge the 12
V battery do not switch off vehicle..... 553
-  Suspended..... 534
-  Switch Off Lights..... 511
-  Switch On Headlamps..... 510
-  Switch on vehicle to charge the
12 V battery..... 553
-  **PARK** Switch on Vehicle to Release
the Parking Brake..... 531
-  Temporarily Unavailable Cam-
era View Restricted..... 541
-  Temporarily Unavailable Radar
Dirty..... 540
-  Vehicle Ready to Drive Switch
the Ignition Off Before Exiting..... 514
-  Vehicle Rising Please Wait..... 546
-  Warning Tire Malfunction..... 557
-  Wheel Sensor(s) Missing..... 556
- Active Blind Spot Assist Currently
Unavailable See Operator's Manual..... 538
- Active Blind Spot Assist Inoperative..... 539
- Active Brake Assist Functions Cur-
rently Limited See Operator's Manual... 550
- Active Brake Assist Functions Limi-
ted See Operator's Manual..... 551
- Active Distance Assist Currently
Unavailable See Operator's Manual..... 534
- Active Distance Assist Inoperative..... 534
- Active Distance Assist Now Available... 535
- Active Emergency Stop Assist Cur-
rently Unavailable See Operator's
Manual..... 536
- Active Emergency Stop Assist Inop-
erative..... 536
- Active Lane Change Assist Currently
Unavailable See Operator's Manual..... 537
- Active Lane Change Assist Inopera-
tive..... 537
- Active Lane Keeping Assist Currently
Unavailable See Operator's Manual..... 539
- Active Lane Keeping Assist Inopera-
tive..... 539
- Active Parking Assist and
PARKTRONIC Inoperative See Opera-
tor's Manual..... 547
- Active Parking Assist Limited Availa-
bility of Maneuvering Assistance See
Operator's Manual..... 546
- Active Steering Assist Currently
Unavailable Due to Multiple Emer-
gency Stops..... 536

- Active Steering Assist Currently Unavailable See Operator's Manual..... 535
- Active Steering Assist Inoperative..... 535
- Active Stop & Go Assist Currently Unavailable See Operator's Manual..... 537
- Active Stop & Go Assist Inoperative See Operator's Manual..... 538
- Adaptive Highbeam Assist Currently Unavailable See Operator's Manual..... 511
- Adaptive Highbeam Assist Inoperative... 511
- Adaptive Highbeam Assist Plus Currently Unavailable See Operator's Manual..... 512
- Adaptive Highbeam Assist Plus Inoperative..... 512
- Ambient Lighting Warning Support Inoperative..... 518
- Apply Brake To Park Service Required... 523
- Auxiliary Battery Malfunction (white display message)..... 526
- Auxiliary Battery Malfunction (red display message)..... 527
- Cannot Start Vehicle See Operator's Manual..... 520, 555
- Change the steering wheel/ seat position until 6 dots are visible on the upper edge of the screen..... 542
- Check Brake Pads See Operator's Manual..... 532
- Decrease Speed..... 558
- Depress Brake to Shift from P..... 522
- Depress Brake to Shift to D or R..... 523
- Depress Brake to Shift to R..... 523
- DIGITAL LIGHT Functions Limited..... 511
- Drive Malfunction Stop Contact Dealer..... 526
- Drive Malfunction Stop Restart Vehicle..... 526
- Drive Overheated Drive Carefully..... 526
- Driver Camera Inoperative See Operator's Manual..... 542
- Driver Camera View Currently Restricted See Operator's Manual..... 541
- Front Passenger Airbag Disabled See Operator's Manual..... 505
- Front Passenger Airbag Enabled See Operator's Manual..... 506
- Hazard Warning Light Malfunction..... 512
- Head-up Display Brightness Currently Reduced See Operator's Manual..... 514
- Head-up Display Currently Unavailable See Operator's Manual..... 514
- Head-up Display Inoperative..... 514
- MULTIBEAM LED Functions Limited..... 511
- N Automatically Activated Please Shift to Transmission Position Again.... 525
- PARKTRONIC Inoperative See Operator's Manual..... 546

- Place the Key in the Marked Space
See Operator's Manual..... 509
- PRE-SAFE Impulse Side Inoperative
See Operator's Manual..... 507
- PRE-SAFE Inoperative See Operator's Manual..... 507
- Push rear-left seat belt extender back manually. See Operator's Manual (example)..... 505
- Reversing Not Possible Service Required..... 525
- Risk of Vehicle Rolling Away Apply Brake to Park..... 524
- Risk of Vehicle Rolling Away Driver's Door Open Position P Not Selected..... 523
- Risk of Vehicle Rolling Away N Activated Manually No Automatic Change to P..... 524
- Service Required Do Not Change Transmission Position..... 525
- Shift to P Only When Vehicle Is Stationary..... 522
- Snow Chain Mode Maximum Speed Exceeded..... 517
- Starting Possible Again..... 555
- Tire Press. Monitor Currently Unavailable..... 555
- Tire Press. Monitor Inoperative..... 555
- Tire Pressure Monitor Inoperative No Wheel Sensors..... 556
- Tires Overheated..... 558
- To Deselect P or N Depress Brake and Start Vehicle..... 523
- To switch vehicle off, press and hold Start/Stop button for at least 3 seconds or press 3 times..... 520
- Traffic Sign Assist Currently Unavailable See Operator's Manual..... 538
- Traffic Sign Assist Inoperative..... 538
- Transmission Malfunction Stop..... 525
- Windshield Wiper Malfunction..... 519
- Distance control**
see Active Distance Assist DISTRONIC
- DISTRONIC**
see Active Distance Assist DISTRONIC
- Door**
Child safety lock (rear doors)..... 73
Locking/unlocking (emergency key)..... 84
Opening (from inside)..... 81
Power closing function..... 83
Unlocking (from inside)..... 81
- Door control panel**..... 18
- Door control panel (rear passenger compartment)**..... 20
- DOT, Tire Identification Number (TIN)**..... 385
- Drawbar**
see Tow-bar system
- Drinking and driving**..... 194
- Drive Away Assist**..... 277
- Drive position**
Inserting..... 205
- Drive program display**..... 202

Drive programs

see DYNAMIC SELECT

Driver camera

Activating/deactivating..... 298
 Overview..... 297

Driver display

48 V on-board electrical system..... 285
 Displaying the service due date..... 337
 EQ Boost technology..... 285
 Function/notes..... 280
 Notes on menus..... 281
 Operating..... 280
 Overview of displays..... 286
 Warning/indicator lamps..... 561

Driver display with driver camera..... 12

Driver's display..... 8

Driver's seat

see Seat

Driving safety system

ABS (Anti-lock Braking System)..... 220
 Active Brake Assist..... 239
 BAS (Brake Assist System)..... 220
 Cameras..... 218

EBD (electronic brake force distribution)..... 222
 ESP® Crosswind Assist..... 222
 Overview..... 219
 Radar and ultrasonic sensors..... 218
 Responsibility..... 218
 STEER CONTROL..... 222

Driving system

see Active Blind Spot Assist
 see Active Distance Assist DISTRONIC
 see Active Emergency Stop Assist
 see Active Lane Change Assist
 see Active Lane Keeping Assist
 see Active Parking Assist
 see Active Speed Limit Assist
 see Active Steering Assist
 see AIRMATIC
 see ATTENTION ASSIST with micro-sleep detection
 see Driving safety system
 see E-ACTIVE BODY CONTROL
 see HOLD function
 see Parking Assist PARKTRONIC
 see Rear view camera
 see Surround view camera

see Traffic Sign Assist

Driving tips

Breaking-in notes..... 192
 Drinking and driving..... 194
 General driving tips..... 194
 Optimized acceleration..... 193

Drowsiness detection

see ATTENTION ASSIST with micro-sleep detection

Dynamic handling control system

see ESP® (Electronic Stability Program)

DYNAMIC SELECT

Calling up the fuel consumption indicator..... 203
 Configuring drive program I..... 202
 Displaying engine data..... 203
 Displaying vehicle data..... 203
 Drive program display..... 202
 Drive programs..... 201
 Function..... 201
 Operating (DYNAMIC SELECT switch)... 202
 Selecting the drive program..... 202

- E**
- E-ACTIVE BODY CONTROL**
 Setting the level..... 260
 Suspension..... 258
- E10**..... 495
- Easy entry feature**
 Function/notes..... 128
 Setting..... 129
- Easy exit feature**
 Function/notes..... 128
 Setting..... 129
- EASY-PACK trunk box**
 Adjusting the height to any position..... 142
 Care..... 348
 Installing/removing..... 143
- EBD (electronic brake force distribution)**
 Function/notes..... 222
- ECO Assist**
 Function/notes..... 199
- ECO display**
 Function..... 199
- ECO start/stop function**
 Automatic engine start..... 198
 Automatic engine stop..... 198
 Switching off/on..... 199
- Electric parking brake**
 Applying automatically..... 214
 Applying/releasing manually..... 215
 Emergency braking..... 215
 Releasing automatically..... 215
- Electrohydraulic suspension**
 see E-ACTIVE BODY CONTROL
- Electronic Stability Program**
 see ESP® (Electronic Stability Program)
- Emergency**
 Assistance overview..... 22
 First-aid kit (soft sided)..... 351
 Reflective safety vest..... 350
 Removing the warning triangle..... 351
 Setting up the warning triangle..... 351
- Emergency braking**..... 215
- Emergency braking**
 see BAS (Brake Assist System)
- Emergency call**
 see Mercedes-Benz emergency call system
- Emergency engine start**..... 368
- Emergency key**
 Locking/unlocking the doors..... 84
- Emergency operation mode**
 Starting the vehicle..... 190
- Emergency release**
 Trunk lid (from inside)..... 91
- Emergency spare wheel**
 Notes..... 401
- Emergency Tensioning Devices**
 Activation..... 43
- Engine**
 ECO start/stop function..... 198
 Engine number..... 492
 Starting (emergency operation mode)... 190
 Starting (Remote Online)..... 191
 Starting (start/stop button)..... 190
 Starting assistance..... 361
 Switching off (start/stop button)..... 210
- Engine data**
 Displaying..... 203

- Engine number**..... 492
- Engine oil**
- Additives..... 497
 - Capacity..... 498
 - Checking the oil level with the driver display..... 340
 - MB-Freigabe or MB-Approval..... 498
 - Quality..... 498
 - Refilling..... 340
- EQ boost**
- Qualified specialist workshop..... 33
- EQ Boost technology**
- Notes..... 285
 - Operating safety..... 28
- ESC (Electronic Stability Control)**
see ESP® (Electronic Stability Program)
- ESP®**
- Crosswind Assist..... 222
- ESP® (Electronic Stability Program)**
- Activating/deactivating..... 222
 - Function/notes..... 221
- Exterior lighting**
- Care..... 346
- Exterior lighting**
see Lights
- Exterior mirrors**
- Automatic mirror folding function..... 174
 - Automatic preselection (MBUX Interior Assistant)..... 296
 - Folding in/out..... 171
 - Operating the memory function..... 130
 - Parking position..... 173
 - Setting..... 171
- F**
- Fatigue detection**
see ATTENTION ASSIST with micro-sleep detection
- Favorites**
- Adding..... 300
- First-aid kit (soft sided)**..... 351
- Flacon**
- Inserting/removing..... 182
- Flat tire**
- Changing a wheel..... 396
 - MOExtended tires..... 352
 - Notes..... 351
- TIREFIT kit..... 353
- Flat towing**
see Tow-bar system
- Floor mats**..... 154
- Fog light (enhanced)**..... 159
- Foil covering**
- Radar and ultrasonic sensors..... 218
- Folding table**..... 137
- Footrest**
- Rear passenger seat..... 116
- Fragrance**
see Perfume atomizer
- Free software**..... 40
- Frequencies**
- Two-way radio..... 403
- Front airbag (driver, front passenger)**..... 49
- Front passenger seat**
- Adjusting from the driver's seat..... 109
 - Adjusting from the rear passenger compartment..... 110
- Front passenger seat**
see Seat

- Fuel**
- Additives..... 496
 - Diesel..... 496
 - E10..... 495
 - Fuel reserve..... 497
 - Gasoline..... 495
 - Low outside temperatures..... 496
 - Quality (diesel)..... 496
 - Quality (gasoline)..... 495
 - Refueling..... 208
 - Sulfur content..... 495
 - Tank content..... 497
- Fuel consumption indicator**
- Calling up..... 203
- Function seat**
- see Door control panel
- Function seat (rear passenger compartment)**
- see Seat (rear passenger compartment)
- Fuses**
- Before replacing a fuse..... 369
 - Dashboard fuse box..... 371
 - Fuse assignment diagram..... 369
 - Fuse box in the engine compartment... 369
 - Fuse box in the front-passenger footwell..... 372
 - Fuse box in the trunk..... 372
 - Notes..... 369
- Fuses**
- see Fuses
- G**
- Garage door opener**
- Clearing the memory..... 214
 - Programming buttons..... 211
 - Resolving problems..... 213
- Garage door openers**
- Opening/closing the door..... 213
 - Synchronizing the rolling code..... 213
- Gasoline**..... 495
- Gearshift recommendation**..... 206
- Genuine parts**..... 25
- Glide mode**..... 207
- Glove box**
- Air vent..... 188
- H**
- Handbrake**
- see Electric parking brake
- Handling characteristics (unusual)**..... 373
- HANDS-FREE ACCESS**..... 89
- Handset**
- Stowage compartment (rear passenger compartment)..... 138
- Hazard warning lights**..... 157
- Hazardous substances**
- Information..... 28
- Head restraint**
- Activating/deactivating neck heating.... 120
 - Attaching/removing the additional cushion (front)..... 119
 - Attaching/removing the additional cushion (rear passenger compartment)..... 120
 - Front (luxury head restraint)..... 118
 - Rear (folding into position/folding back mechanically)..... 121
 - Rear (lowering from the front)..... 119

- Rear passenger compartment (adjusting)..... 119
 Rear passenger compartment (luxury head restraint)..... 120
- Head-up Display**
 Augmented reality..... 282
 Care..... 348
 Function..... 282
 Operating..... 284
 Operating the memory function..... 130
 Selecting (with augmented reality)..... 284
 Switching on/off..... 285
- Headlamps**
 see Automatic driving lights
- Headliner (care)**..... 348
- Heating**
 see Climate control
- Help call**
 see Mercedes-Benz emergency call system
- High beam**
 Activating/deactivating..... 156
- High beam**
 see Adaptive Highbeam Assist
- High-beam flasher**..... 156
- High-beam headlamps**
 Adaptive Highbeam Assist Plus..... 163
- Highway mode**..... 159
- Hill start assist**..... 224
- HOLD function**
 Function/notes..... 223
 Switching on/off..... 223
- Home screen (central display)**
 Overview..... 288
- Hood**
 Opening/closing..... 338
- I**
- Identification plate**
 Engine..... 492
 Refrigerant..... 500
 Vehicle..... 492
- Ignition**
 Switching on (start/stop button)..... 189
- Ignition key**
 see SmartKey
- Immediate pre-entry climate control**..... 185
- Immobilizer**..... 103
- Indicator lamp**
 see Warning/indicator lamp
- Individual drive program**
 Configuring..... 202
 Selecting..... 202
- Inside rearview mirror**
 Anti-glare mode (automatic)..... 173
- Inside rearview mirror**
 see Outside mirrors
- Inspection**
 see ASSYST PLUS
- Instrument cluster**
 see Driver display
- Intelligent Light System**
 Activating/deactivating..... 161
 Active headlamps..... 158
 Adaptive Highbeam Assist..... 161
 Adaptive Highbeam Assist Plus..... 163
 Assistance functions..... 160
 Bad weather light..... 159
 City lighting..... 159

- Cornering light..... 158
- Fog light (enhanced)..... 159
- Highway mode..... 159
- Overview..... 158
- Topographical compensation..... 159
- Interior lighting**
 - Adjusting..... 165
 - Ambient lighting..... 166
 - Reading lamp..... 165
 - Switch-off delay time..... 167
- Interior motion sensor**
 - Activating/deactivating..... 105
 - Function..... 104
- Internet radio**
 - see TuneIn
- Ionization**
 - Activating/deactivating (MBUX multimedia system)..... 181
- iPhone®**
 - see Smartphone integration
- J**
- Jack**
 - Storage location..... 395
- Jump-start connection**
 - General notes..... 359
- K**
- KEYLESS-GO**
 - Deactivating a function..... 78
 - Locking/unlocking the vehicle..... 81
 - Problem..... 83
 - Unlocking setting..... 77
- Kickdown**
 - Using..... 207
- Knee airbag**..... 49
- L**
- Labeling (tires)**
 - see Tire labeling
- Lamp**
 - see Interior lighting
- Lamp (driver display)**
 - see Warning/indicator lamp
- Lane detection (automatic)**
 - see Active Lane Keeping Assist
- Lane Keeping Assist**
 - see Active Lane Keeping Assist
- Language**
 - Notes..... 306
 - Setting..... 306
- LATCH-type (ISOFIX) child seat anchor**
 - Installing..... 67
- Level control system**
 - see AIRMATIC
 - see E-ACTIVE BODY CONTROL
- Light switch**
 - Overview..... 155
- Lighting**
 - see Interior lighting
 - see Lights
- Lights**
 - Active headlamps..... 158
 - Adaptive Highbeam Assist..... 161
 - Adaptive Highbeam Assist Plus..... 163
 - Automatic driving lights..... 156
 - Bad weather light..... 159
 - City lighting..... 159
 - Combination switch..... 156

- Cornering light..... 158
 Fog light (enhanced)..... 159
 Hazard warning lights..... 157
 High beam..... 156
 High-beam flasher..... 156
 Highway mode..... 159
 Intelligent Light System..... 158
 Light switch..... 155
 Low-beam headlamps..... 155
 Parking lights..... 155
 Rear fog lamp..... 155
 Responsibility for lighting systems..... 155
 Setting the exterior lighting switch-off delay time..... 164
 Standing lights..... 155
 Switching the Intelligent Light System on/off..... 161
 Switching the locator lighting on/off.... 165
 Turn signal light..... 156
- Limited Warranty**
 Vehicle..... 35
- Live Traffic Information**
 Switching the traffic information display on..... 313
- Load index (tires)..... 387**
- Load-bearing capacity (tires)..... 387**
- Loading**
 Bag hook..... 141
 Definitions..... 389
 Notes..... 134
 Roof luggage rack..... 144
- Loading guidelines..... 134**
- Loading information table..... 380**
- Loads**
 Securing..... 134
- Locator lighting**
 Activating/deactivating..... 165
- Locking/unlocking**
 Emergency key..... 84
 KEYLESS-GO..... 81
 Switching the automatic locking feature on/off..... 83
 Unlocking/opening the doors from the inside..... 81
- Low-beam headlamps**
 Switching on/off..... 155
- Lubricant additives**
 see Additives
- Luggage**
 Net hooks..... 139
 Securing..... 134
- M**
- MAGIC VISION CONTROL**
 Windshield wipers..... 170
- Maintenance**
 Vehicle..... 28
- Maintenance**
 see ASSYST PLUS
- Malfunction**
 Restraint system..... 43
- Malfunction message**
 see Display message
- Maneuvering assistance**
 Activating/deactivating..... 279
 Cross traffic warning..... 277
 Drive Away Assist..... 277
 Maneuvering brake function..... 278
- Maneuvering brake function..... 278**
- Map**
 Displaying online map contents..... 313

- Displaying weather information..... 313
- Moving..... 312
- Selecting the map orientation..... 312
- Setting the map scale..... 312
- Message program**
 - Overview..... 123
- Message programs**
 - Resetting the settings..... 124
 - Selecting the front seats..... 124
- Maximum load rating**..... 386
- Maximum permissible load**
 - Calculation example..... 382
 - Determining..... 381
- Maximum tire pressure**..... 386
- MBUX Interior Assistant**
 - Anticipatory exit warning..... 294
 - Automatic preselection of the out-side mirror..... 296
 - Calling up favorites with the V pose..... 297
 - Operating the function with the favorites pose..... 297
 - Overview..... 292
- Switching the reading light for the driver and front passenger on/off contact-free..... 295
- Switching the search light for the driver on/off..... 295
- MBUX multimedia system**
 - Activating/deactivating snow chain mode..... 374
 - Activating/deactivating standby mode.. 217
 - Collision detection (parked vehicle)..... 216
 - Configuring display settings..... 285
 - Configuring drive program I..... 202
 - Coupling the steering wheel heater to the seat heating..... 128
 - Driver camera..... 297
 - Home screen..... 288
 - Notes..... 287
 - Operating the touchscreen..... 289
 - Overview..... 287
 - Resetting (factory setting)..... 306
 - Setting route-based speed adaptation.. 232
 - Setting the air distribution..... 179
 - Setting the footwell temperature..... 180
 - Setting the fragrance system..... 181
 - Setting the rear climate control..... 180
 - Switching ionization on/off..... 181
- MBUX multimedia system**
 - see Display (MBUX multimedia system)
 - see MBUX Interior Assistant
- MBUX Voice Assistant**
 - Function..... 290
 - Voice prompting..... 291
- Mechanical key**
 - Inserting/removing..... 78
 - Unlocking the trunk lid..... 91
- Media**
 - Overview of the functions and symbols..... 329
- Medical aids**..... 34
- Memory function**
 - Function..... 129
 - Head-up Display – Calling up stored settings..... 130
 - Head-up Display – Storing settings..... 130
 - Operating..... 130
 - Outside mirrors – Calling up stored settings..... 130
 - Outside mirrors – Storing settings..... 130
 - Seat – Calling up stored settings..... 130

- Seat – Storing settings..... 130
 - Steering wheel – Calling up saved settings..... 130
 - Steering wheel – Saving settings..... 130
 - Memory function in the rear passenger compartment**
 - Function..... 131
 - Operating rear seats..... 132
 - Operating the front passenger seat and rear seats..... 133
 - Menus (driver display)**
 - Notes..... 281
 - Mercedes me app**
 - Information..... 324
 - Mercedes me calls**
 - Arranging a service appointment..... 323
 - Calling the Mercedes-Benz Customer Center..... 322
 - Calling the Mercedes-Benz Customer Center after automatic accident or breakdown detection..... 322
 - Information..... 321
 - Making a call via the overhead control panel..... 321
 - Transferred data..... 323
 - Mercedes me connect**
 - Accident and Breakdown Management..... 320
 - Information..... 319
 - Transferred data..... 321
 - Mercedes-Benz emergency call system**
 - Automatic emergency call..... 327
 - Information..... 326
 - Information on data processing..... 328
 - Manual emergency call..... 328
 - Overview..... 327
 - Message (driver display)**
 - see Display message
 - Message memory**..... 503
 - Mirrors**
 - see Exterior mirrors
 - Mobile phone**
 - Wireless charging (rear passenger compartment)..... 153
 - Mobile phone**
 - see Smartphone integration
 - see Telephone
 - Model series**
 - see Vehicle identification plate
 - MOExtended tires**..... 352
 - MULTIBEAM LED**
 - Intelligent Light System..... 158
 - Multifunction camera**
 - ROAD SURFACE SCAN..... 260
 - Multimedia system**
 - Enabling/disabling the rear airbag..... 60
 - Multimedia system**
 - see MBUX multimedia system
- N**
- Navigation**
 - Notes..... 307
 - Overview..... 308
 - Switching on..... 307
 - Navigation**
 - see Destination entry
 - see Map
 - see Route
 - Neutral**
 - Engaging..... 204

Nodding off

see ATTENTION ASSIST with micro-sleep detection

O**Occupant safety**

see Airbag
 see Automatic co-driver airbag shutoff
 see Automatic measures after an accident
 see Child seat
 see Pets in the vehicle
 see Post-collision brake
 see PRE-SAFE® (anticipatory occupant protection)
 see PRE-SAFE® Impulse Side
 see PRE-SAFE® PLUS (anticipatory occupant protection plus)
 see Rear airbag
 see Restraint system
 see Seat belt

Oil

see Engine oil

On-board diagnostics interface

see Diagnostics connection

On-board electronics

Notes..... 402
 Two-way radios..... 402

Online services

Data storage..... 38

Open-source software..... 40**Opening the trunk lid using your foot**

HANDS-FREE ACCESS..... 89

Operating fluids

Additives (fuel)..... 496
 Brake fluid..... 498
 Coolant (engine)..... 499
 Engine oil..... 497
 Fuel (diesel)..... 496
 Fuel (gasoline)..... 495
 Notes..... 494
 Refrigerant (air conditioning system)..... 500
 Windshield washer fluid..... 500

Operating safety

48 V on-board electrical system..... 28
 Declaration of conformity (wireless vehicle components)..... 30
 EQ Boost technology..... 28
 Information..... 28

Operator's Manual

Vehicle equipment..... 26

Operator's Manual (digital)..... 24**Optimized acceleration**

Activating..... 193

Outside mirrors

Anti-glare mode (automatic)..... 173

Overhead control panel

Overview..... 16

P**Paint code..... 492****Paintwork (cleaning instructions)..... 345****Panel heating**

Setting..... 125

Panic alarm

Activating/deactivating..... 77

Panorama roof with power tilt/sliding panel

see Sliding sunroof

Parcel net hooks..... 139

- Park position**
 Engaging..... 205
 Selecting automatically..... 205
- Parking**
 see Electric parking brake
- Parking aid**
 see Parking Assist PARKTRONIC
- Parking Assist PARKTRONIC**
 Activating..... 271
 Adjusting warning tones..... 271
 Function..... 268
 Switching off..... 271
 System limitations..... 268
- Parking assistance systems**
 see Active Parking Assist
- Parking brake**
 see Electric parking brake
- Parking for an extended period**..... 217
- Parking lights**..... 155
- Parking position**
 Exterior mirrors..... 173
- Storing the position of the front-passenger outside mirror using reverse gear..... 174
- Particulate status display**..... 178
- PASSENGER AIR BAG status display**
 see Automatic front passenger front airbag shutoff
- Payload**
 Calculation example..... 382
 Determining the maximum..... 381
- Perfume**
 see Perfume atomizer
- Perfume atomizer**
 Inserting/removing the flacon..... 182
 Setting..... 181
- Perfume vial**
 see Perfume atomizer
- Period out of use**
 Activating/deactivating standby mode.. 217
 Standby mode function..... 217
- Permitted towing methods**..... 363
- Pets in the vehicle**..... 75
- Plastic trim (Care)**..... 348
- Post-collision brake**..... 61
- Power closing function**
 Door..... 83
 Trunk lid..... 86
- Power supply**
 Switching on (start/stop button)..... 189
- Power washer (care)**..... 344
- Pre-entry climate control (immediate)**... 185
- Pre-entry climate control at departure time**
 Function..... 183
 Setting..... 184
 Switching on/off..... 185
- PRE-SAFE® (anticipatory occupant protection)**
 Function..... 60
 PRE-SAFE® Sound..... 60
 Reversing measures..... 60
- PRE-SAFE® Impulse Side**
 Activation..... 43
 Function..... 61

PRE-SAFE® PLUS (anticipatory occupant protection plus)

- Function..... 60
- Reversing measures..... 60

Preventative occupant protection system

- see PRE-SAFE® (anticipatory occupant protection)
- see PRE-SAFE® PLUS (anticipatory occupant protection plus)

Profile

- Notes..... 298

Program

- see DYNAMIC SELECT

Protecting the environment

- Notes..... 25

Protection against collision

- see Drive Away Assist
- see Maneuvering brake function

Pulling away

- see Driving tips

Q**QR code**

- Rescue card..... 35

Qualified specialist workshop..... 33**R****Radar and ultrasonic sensors**

- Damage..... 218

Radio

- Overview of the functions and symbols..... 331

Rain-closing feature

- Sliding sunroof..... 99

Reading lamp

- see Interior lighting

Reading light

- Switching on/off with hand movements..... 295

Real wood (Care)..... 348**Rear airbag**

- Activating/deactivating..... 60

- Points to remember when the rear seat is occupied..... 57
- REAR SEAT AIR BAG indicator lamps..... 59

Rear axle steering..... 197**Rear climate control**

- Setting (MBUX multimedia system)..... 180

Rear doors (child safety lock)..... 73**Rear fog lamp**

- Switching on/off..... 156

Rear passenger compartment seat

- Seats..... 111

REAR SEAT AIR BAG status display

- see Rear airbag

Rear view camera

- Activating using GPS (surround view camera)..... 267
- Care..... 346
- Function..... 261
- Opening the camera cover (surround view camera)..... 268
- Setting (surround view camera)..... 267

Rear window

- Roller sunblind..... 101

- Rear window heater**..... 176
- Reflective safety vest**..... 350
- Refrigerant (air conditioning system)**
Notes..... 500
- Refrigerator box**
Removing/installing..... 150
Stowage compartment..... 151
Using..... 148
- Refueling**
Refueling the vehicle..... 208
- Regulatory radio identification**..... 404
- Remote Online**
Charging the starter battery..... 191
Cooling/heating the vehicle interior..... 191
Starting the vehicle..... 191
- Reporting safety defects**..... 34
- Rescue card**..... 35
- Reserve**
Fuel..... 497
- Reset function (MBUX multimedia system)**..... 306
- Reset function (MBUX multimedia system)**
see Reset function (MBUX multimedia system)
- Resetting (factory setting)**
see Reset function (MBUX multimedia system)
- Residual heat**
Rear operating unit..... 181
- Restraint system**
Basic instructions for children..... 62
Function in an accident..... 43
Functionality..... 42
Malfunction..... 43
Protection..... 42
Reduced protection..... 42
Self-test..... 42
Warning lamp..... 42
- Reverse gear**
Engaging..... 204
- Rims (care)**..... 346
- ROAD SURFACE SCAN**
Multifunction camera..... 260
- ROAD SURFACE SCAN**
see Camera
- Roadside Assistance (breakdown)**..... 28
- Roll away protection**
see HOLD function
- Roller sunblind**
Rear window..... 101
Side windows (electric)..... 101
Sliding sunroof..... 96
- Roof load**..... 502
- Roof luggage rack**
Loading..... 144
Securing..... 144
- Route**
Activating a commuter route..... 310
Calculating..... 310
Selecting a type..... 310
Selecting an alternative route..... 310
- Route guidance with augmented reality**
Activating..... 310
Activating/deactivating the traffic light view..... 248

Displaying street names and house numbers.....	310
Route-based speed adaptation	
Function.....	231
Setting.....	232
Run-flat characteristics	
MOExtended tires.....	352
S	
Safety systems	
see Driving safety system	
Satellite radio	
Logging in.....	335
Setting music and sport alerts.....	335
Search light	
Switching on/off with hand movements.....	295
Seat	
Adjusting (electrically).....	106
Adjusting a reclining rear seat.....	112
Adjusting the front passenger seat from the rear passenger compartment..	110
Automatic seat adjustment.....	122
Configuring the settings.....	122

Correct driver's seat position.....	106
Massage program overview.....	123
Operating the memory function.....	130
Panel heating.....	125
Rear passenger compartment footrest..	116
Resetting the settings.....	124
Setting automatic lateral support adjustment.....	123
Setting options.....	18
Setting the fully reclined position.....	113
Workout program overview.....	123

Seat

- see Chauffeur mode
- see Front passenger seat

Seat (rear passenger compartment)

Setting options.....	20
----------------------	----

Seat belt

Care.....	348
Protection.....	44

Seat belt adjustment

Activating/deactivating.....	49
Function.....	49

Seat belt extender..... 47**Seat belt warning**

- see Seat belts

Seat belts

Activating/deactivating seat belt adjustment.....	49
Adjusting the height.....	48
Belt airbag.....	47
Fastening.....	48
Reduced protection.....	45
Releasing.....	49
Seat belt adjustment (function).....	49
Seat belt extender.....	47
Warning lamp.....	49

Seat cover (Care)..... 348**Seat heating**

Activating/deactivating.....	124
------------------------------	-----

Seat ventilation

Activating/deactivating.....	126
------------------------------	-----

Seats

Rear passenger compartment (adjusting electrically).....	111
--	-----

Selecting a gear

- see Changing gears

- Selector lever**
 - see DIRECT SELECT lever
- Self-test**
 - Automatic front passenger front air-bag shutoff..... 55
- Sensors (care)..... 346**
- Service Center**
 - see Qualified specialist workshop
- Service interval display**
 - see ASSYST PLUS
- Setting the footwell temperature**
 - Setting..... 180
- Setting the map scale**
 - see Map
- Shift paddles**
 - see Steering wheel paddle shifters
- Shifting gears**
 - Gearshift recommendation..... 206
- Side airbag..... 49**
- Side windows**
 - Child safety lock in the rear passenger compartment..... 75
 - Closing using the SmartKey..... 94
 - Convenience closing..... 94
 - Convenience opening..... 94
 - Opening with the SmartKey..... 94
 - Opening/closing..... 92
 - Problem..... 95
 - Roller sunblind (electric)..... 101
- Size designation (tires)..... 387**
- Sliding sunroof**
 - Automatic functions..... 99
 - Closing..... 96
 - Closing using the SmartKey..... 94
 - Opening..... 96
 - Opening with the SmartKey..... 94
 - Problem..... 99
 - Rain-closing feature..... 99
- SmartKey**
 - Acoustic locking verification signal..... 77
 - Battery..... 78
 - Deactivating a function..... 78
 - Energy consumption..... 78
 - Function overview..... 76
 - Key ring attachment..... 78
 - Mechanical key..... 78
 - Panic alarm..... 77
 - Problem..... 80
 - Unlocking setting..... 77
- SmartKey**
 - see SmartKey
- Smartphone**
 - see Smartphone integration
 - see Telephone
- Smartphone integration**
 - Overview..... 325
- Snow chain mode**
 - Activating/deactivating..... 374
- Snow chains..... 374**
- Socket (12 V)**
 - Rear passenger compartment..... 146
- Socket (115 V)**
 - Rear passenger compartment..... 147
- Software update**
 - System updates..... 303
- Sound**
 - PRE-SAFE® Sound..... 60
 - Wheels and tires..... 373
- Sound menu**
 - Functions overview..... 336

- Spare wheel**
see Emergency spare wheel
- Special seat belt retractor**..... 66
- Specialist workshop**
see Qualified specialist workshop
- Speed index (tires)**..... 387
- Standby mode**
Activating/deactivating..... 217
Function..... 217
- Standing lights**..... 155
- Start-off assist**
see Optimized acceleration
- Start/stop button**
Parking the vehicle..... 210
Starting the vehicle..... 190
Switching on the power supply/ignition..... 189
- Start/stop function**
see ECO start/stop function
- Starter battery**
Charging (Remote Online)..... 191
- Starting**
see Vehicle
- Starting assistance**
see Jump-start connection
- Starting-off aid**
see Hill start assist
- STEER CONTROL**
Function/notes..... 222
- Steering**
Rear axle steering..... 197
- Steering wheel**
Adjusting (electrically)..... 126
Care..... 348
Operating the memory function..... 130
Steering wheel heater..... 127
- Steering wheel heater**
Activating/deactivating..... 127
Coupling to seat heating..... 128
- Steering wheel paddle shifters**..... 206
- Storage areas**
see Storage space
- Storage compartments**
see Storage space
- Storage space**
Armrest..... 137
Center console..... 137
Door..... 137
Glove box..... 137
- Stowage compartment**
Handset (rear passenger compartment)..... 138
Parcel net hooks..... 139
- Street names and house numbers**
Displaying..... 310
- Sulfur content**..... 495
- Surround View**
see Surround view camera
- Surround view camera**
Activating using GPS (rear view camera)..... 267
Button..... 267
Care..... 346
Function..... 263
Opening the camera cover (rear view camera)..... 268
Selecting a view..... 267
Setting (rear view camera)..... 267

- Suspension**
 Setting the suspension level (AIR-MATIC)..... 257
 Setting the suspension level (E-ACTIVE BODY CONTROL)..... 260
- Suspension**
 see AIRMATIC
 see E-ACTIVE BODY CONTROL
- Suspension level (AIRMATIC)**
 Setting..... 257
- Suspension level (E-ACTIVE BODY CONTROL)**
 Setting..... 260
- Switch-off delay time**
 Exterior..... 164
 Interior..... 167
- Synchronization function**
 Activating/deactivating (MBUX multimedia system)..... 180
- System settings**
 Overview of the system settings menu..... 302
 Reset function (MBUX multimedia system)..... 306
- System settings**
 see Language
- T**
- Tailpipes (care)**..... 346
- Tank content**
 Fuel..... 497
 Reserve (fuel)..... 497
- Technical data**
 Information..... 402
 Regulatory radio identification..... 404
- Telephone**
 Connecting a mobile phone (Passkey)... 319
 Connecting a mobile phone (Secure Simple Pairing)..... 319
 Function/notes..... 151
 Functions in the telephone menu..... 319
 Notes..... 316
 Operating modes..... 318
 Telephone menu overview..... 318
 Wireless charging (mobile phone in the rear passenger compartment)..... 153
- Telephony operating modes**
 Bluetooth® Telephony..... 318
- Temperature**..... 176
- Temperature grade**..... 384
- Through-loading feature**
 Locking..... 141
- Through-loading feature in the rear passenger compartment**
 Opening..... 139
- TIN (Tire Identification Number)**..... 385
- Tire and Loading Information placard**.... 380
- Tire characteristics**..... 387
- Tire inflation compressor**
 see TIREFIT kit
- Tire information table**..... 380
- Tire labeling**
 Characteristics..... 387
 DOT, Tire Identification Number (TIN).... 385
 Load index..... 387
 Load-bearing capacity..... 387
 Maximum tire load..... 386
 Maximum tire pressure..... 386
 Overview..... 384
 Speed rating..... 387
 Temperature grade..... 384

- Tire Quality Grading..... 384
- Tire size designation..... 387
- Traction grade..... 384
- Tread wear grade..... 384
- Tire load (maximum)**..... 386
- Tire pressure**
 - Checking (manually)..... 377
 - Checking (tire pressure monitoring system)..... 379
 - Maximum..... 386
 - Notes..... 375
 - Restarting the tire pressure monitoring system..... 379
 - Tire pressure monitoring system (function)..... 378
 - Tire pressure table..... 376
 - TIREFIT kit..... 353
- Tire pressure monitor**
 - Checking the tire pressure..... 379
 - Checking the tire temperature..... 379
 - Function..... 378
 - Restarting..... 379
- Tire pressure table**..... 376
- Tire Quality Grading**..... 384
- Tire temperature**
 - Checking (tire pressure monitoring system)..... 379
 - Tire pressure monitoring system (function)..... 378
- Tire tread**..... 373
- Tire-change tool kit**
 - Overview..... 395
- TIREFIT kit**
 - Storage location..... 353
 - Using..... 353
- Tires**
 - Characteristics..... 387
 - Checking..... 373
 - Checking the tire pressure (manually)... 377
 - Checking the tire pressure (tire pressure monitoring system)..... 379
 - Definitions..... 389
 - DOT, Tire Identification Number (TIN)... 385
 - Flat tire..... 351
 - Installing..... 399
 - Load index..... 387
 - Load-bearing capacity..... 387
 - Maximum tire load..... 386
 - Maximum tire pressure..... 386
 - MOExtended tires..... 352
 - Noise..... 373
 - Notes on installing..... 392
 - Overview of tire labeling..... 384
 - Removing..... 398
 - Replacing..... 392, 396
 - Replacing the wheel trim..... 396
 - Restarting the tire pressure monitoring system..... 379
 - Rotating..... 394
 - Selection..... 392
 - Snow chains..... 374
 - Speed rating..... 387
 - Storing..... 395
 - Temperature grade..... 384
 - Tire and Loading Information placard... 380
 - Tire pressure (notes)..... 375
 - Tire pressure monitoring system (function)..... 378
 - Tire pressure table..... 376
 - Tire Quality Grading..... 384
 - Tire size designation..... 387
 - TIREFIT kit..... 353
 - Traction grade..... 384
 - Tread wear grade..... 384

- Unusual handling characteristics..... 373
- Toll system**
 - Windshield..... 174
- Tool**
 - see Vehicle tool kit
- Top Tether**..... 69
- Touch Control**
 - Driver display..... 280
 - Operating..... 289
- Touch-sensitive controls**..... 27
- Touchscreen**
 - Operating..... 289
- Tow-away alarm**
 - Activating/deactivating..... 104
 - Function..... 104
- Tow-bar system**..... 279
- Tow-starting**..... 368
- Towing away**..... 364
- Towing eye**
 - Installing..... 368
 - Storage location..... 368
- Towing methods**..... 363
- Traction grade**..... 384
- Traffic information**
 - Switching on the display..... 313
- Traffic Light Assistant**
 - Traffic light data service..... 248
- Traffic light data service**
 - Messages on the driver's display..... 248
- Traffic light view**
 - Activating/deactivating..... 248
 - Information..... 248
- Traffic Sign Assist**
 - Function/notes..... 244
 - Setting..... 247
 - System limits..... 244
- Transmission**
 - Engaging neutral..... 204
- Transmission position display**..... 203
- Transporting**
 - Loading guidelines..... 134
 - Vehicle..... 365
- Tread wear grade**..... 384
- Trim element (Care)**..... 348
- Trunk box**
 - see EASY-PACK trunk box
- Trunk lid**
 - Activating/deactivating the trunk lid
 - opening height restriction..... 92
 - Closing..... 86
 - Emergency release (from inside)..... 91
 - HANDS-FREE ACCESS..... 89
 - Locking separately..... 91
 - Opening..... 85
 - Opening dimensions..... 501
 - Power closing function..... 86
 - Unlocking (mechanical key)..... 91
- Tuneln**
 - Calling up..... 334
- Turn signal indicator**..... 156
- Turn signal light**
 - Activating/deactivating..... 156
- Two-way radios**
 - Frequencies..... 403
 - Notes on installation..... 402
 - Transmission output (maximum)..... 403

- U**
- Unlocking**
see Locking/unlocking
- Unlocking setting**..... 77
- Updates**
Important system updates..... 303
- USB port**
Front storage compartment..... 137
Rear passenger compartment..... 148
- User profiles**
Adding a user..... 300
Selecting user options..... 300
- V**
- Vehicle**
Activating/deactivating standby mode.. 217
Collision detection (parking)..... 216
Correct use..... 33
Data acquisition..... 36
Data storage..... 36
Diagnostics connection..... 32
Equipment..... 26
Limited Warranty..... 35
- Locking (automatically)..... 83
Locking/unlocking (emergency key)..... 84
Locking/unlocking (from inside)..... 81
Locking/unlocking (KEYLESS-GO)..... 81
Lowering..... 400
Maintenance..... 28
Medical aids..... 34
Parking for an extended period..... 217
Problem notification..... 34
QR code rescue card..... 35
Qualified specialist workshop..... 33
Raising..... 396
Standby mode function..... 217
Starting (emergency operation mode)... 190
Starting (Remote Online)..... 191
Starting (start/stop button)..... 190
Switching off (start/stop button)..... 210
Towing..... 279
Ventilating (convenience opening)..... 94
- Vehicle battery**
see Battery (vehicle)
- Vehicle data**
Displaying (DYNAMIC SELECT)..... 203
Roof load..... 502
Turning circle..... 501
- Vehicle height..... 501
Vehicle length..... 501
Vehicle width..... 501
Wheelbase..... 501
- Vehicle data storage**
Event data recorders..... 39
MBUX multimedia system/Mercedes
me connect..... 39
- Vehicle dimensions**..... 501
- Vehicle identification number**
see VIN
- Vehicle identification plate**
Paint code..... 492
VIN..... 492
- Vehicle interior**
Cooling or heating (Remote Online)..... 191
- Vehicle maintenance**
see ASSYST PLUS
- Vehicle operation**
Outside the USA or Canada..... 27
- Vehicle sensors**
Information..... 218

Vehicle tool kit

- TIREFIT kit..... 353
- Towing eye..... 368

Ventilating

- Convenience opening..... 94

Ventilation

- see Climate control

Vents

- see Air vents

VIN

- Identification plate..... 492
- Seat..... 492
- Windshield..... 492

Vision

- Removing condensation from the windows..... 180
- Windshield heater..... 183

W**Warning lamp**

- see Warning/indicator lamp











Warning system













- see ATA (anti-theft alarm system)









Warning triangle

- Removing..... 351
- Setting up..... 351

Warning/indicator lamp

-  ABS warning lamp..... 574
-  Active Brake Assist warning lamp..... 573
-  Brake system warning lamp (Canada only)..... 572
-  Brake warning lamp (USA only).... 572
-  Brakes warning lamp (yellow) (Canada only)..... 571
-  Coolant warning lamp (red)..... 566
-  Coolant warning lamp (yellow).... 567
-  Electric parking brake indicator lamp (red) (Canada only)..... 570
-  Electric parking brake indicator lamp (red) (USA only)..... 570
-  Electrical malfunction warning lamp..... 568
-  Engine diagnosis warning lamp.... 568

-  ESP® OFF warning lamp..... 576
-  ESP® warning lamp flashes..... 575
-  ESP® warning lamp lights up..... 575
-  Fuel reserve warning lamp flashes..... 568
-  Fuel reserve warning lamp lights up..... 569
-  Mercedes-Benz emergency call system warning lamp..... 577
-  Power steering warning lamp (red)..... 564
-  Power steering warning lamp (yellow)..... 564
-  Rear axle steering warning lamp (red)..... 565
-  Rear axle steering warning lamp (yellow)..... 565
-  Recuperative Brake System warning lamp (USA only)..... 571
-  Restraint system warning lamp.... 562

-  Seat belt warning lamp flashes.... 563
-  Seat belt warning lamp lights up..... 563
-  Suspension warning lamp (red).... 574
-  Suspension warning lamp (yellow)..... 573
-  The electric parking brake (yellow) indicator lamp..... 570
-  Tire pressure monitoring system warning lamp flashes..... 577
-  Tire pressure monitoring system warning lamp lights up..... 578
-  Warning lamp for distance warning function..... 573
- Overview..... 561
- REAR SEAT AIR BAG..... 59
- Warning/indicator lamps**
- PASSENGER AIR BAG..... 55
- Warranty**..... 35
- Washer fluid**
- see Windshield washer fluid
- Washing by hand (care)**..... 345
- Water tank**
- see Air-water duct
- Weather information**..... 313
- Web browsers**
- Overview..... 325
- Wheel change**
- Lowering the vehicle..... 400
- Mounting a new wheel..... 399
- Removing a wheel..... 398
- Removing/installing hub caps..... 396
- Wheel rotation**..... 394
- Wheels**
- Care..... 346
- Checking..... 373
- Checking the tire pressure (manually)... 377
- Checking the tire pressure (tire pressure monitoring system)..... 379
- Definitions..... 389
- DOT, Tire Identification Number (TIN).... 385
- Flat tire..... 351
- Installing..... 399
- Load index..... 387
- Load-bearing capacity..... 387
- Maximum tire load..... 386
- Maximum tire pressure..... 386
- MOExtended tires..... 352
- Noise..... 373
- Notes on installing..... 392
- Overview of tire labeling..... 384
- Removing..... 398
- Replacing..... 392, 396
- Replacing the hub cap..... 396
- Restarting the tire pressure monitoring system..... 379
- Rotating..... 394
- Selection..... 392
- Snow chains..... 374
- Speed rating..... 387
- Storing..... 395
- Temperature grade..... 384
- Tire and Loading Information placard.... 380
- Tire characteristics..... 387
- Tire pressure (notes)..... 375
- Tire pressure monitoring system (function)..... 378
- Tire pressure table..... 376

- Tire Quality Grading..... 384
- Tire size designation..... 387
- TIREFIT kit..... 353
- Traction grade..... 384
- Tread wear grade..... 384
- Unusual handling characteristics..... 373
- Wi-Fi**
 - Configuring..... 304
- Window curtain airbag**..... 49
- Window lifter**
 - see Side windows
- Windows**
 - Care..... 346
- Windows**
 - see Side windows
- Windshield**
 - Defrosting..... 176
 - Infrared reflective..... 175
 - Radio waves..... 174
 - Replacing the wiper blades..... 168
 - Replacing wiper blades (MAGIC VISION CONTROL)..... 170
- Windshield**
 - see Windshield
- Windshield heater**..... 183
- Windshield heater**
 - see Windshield heater
- Windshield washer fluid**
 - Notes..... 500
- Windshield washer system**
 - Refilling..... 342
- Windshield wipers**
 - Activating/deactivating..... 168
 - Replacing the wiper blades..... 168
 - Replacing wiper blades (MAGIC VISION CONTROL)..... 170
- Winter operation**
 - Activating/deactivating snow chain mode..... 374
 - Snow chains..... 374
- Wiper blades**
 - Care..... 346
 - Replacing..... 168
 - Replacing (MAGIC VISION CONTROL).... 170
- Wireless charging**
 - Function/notes..... 151
 - Mobile phone..... 152
 - Mobile phone (rear passenger compartment)..... 153
- Wireless vehicle components**
 - Declaration of conformity..... 30
- Workout program**
 - Overview..... 123
- Workshop**
 - see Qualified specialist workshop





