



#### Digital – in the vehicle

Explore the Operator's Manual in the multimedia system under "Vehicle". Begin with Quick Start and discover highlights and useful tips.



#### Vehicle document wallet

This contains a physical copy of comprehensive information about operating your vehicle and about services and your vehicle's warranty.



1185847609

Order no. P118 0656 13 Part no. 118 584 76 09  
Edition B-2024

CLA

Mercedes-Benz



CLA

Operator's Manual

Mercedes-Benz



## Front passenger air bag warning

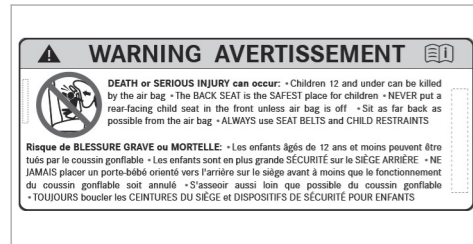
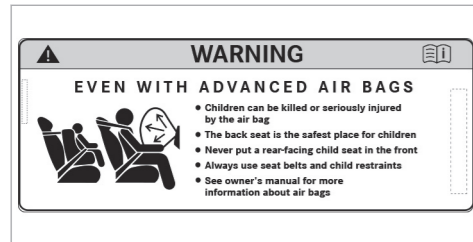

Air bag warning sticker for USA and Canada

**WARNING** Risk of injury or fatal injuries if the front passenger air bag is enabled

If the front passenger air bag is enabled, a child on the front passenger seat may be struck by the front passenger air bag in the event of an accident.

▶ NEVER use a rearward-facing child restraint system on a seat with an ENABLED FRONT AIR BAG. This can result in the DEATH of or SERIOUS INJURY to the CHILD.

Observe the chapter "Children in the vehicle".

## Publication details

### Internet

Further information about Mercedes-Benz vehicles and about Mercedes-Benz AG can be found on the following websites:

<https://www.mbusa.com> (USA only)

<https://www.mercedes-benz.ca> (Canada only)

### Documentation team

©Mercedes-Benz AG: Not to be reprinted, translated or otherwise reproduced, in whole or in part, without written permission from Mercedes-Benz AG.

### Vehicle manufacturer

Mercedes-Benz AG

Mercedesstraße 120

70372 Stuttgart

Germany

## Welcome to the world of Mercedes-Benz

Before your first drive, please read this Operator's Manual carefully and familiarize yourself with your vehicle. For your own safety and a longer service life of the vehicle, follow the instructions and warning notices in this Operator's Manual. Disregarding them may lead to damage to the vehicle or injury to people.

Damage to the vehicle resulting from the disregard of the instructions is not covered by the Mercedes-Benz Limited warranty.

The standard equipment and product description of your vehicle may vary and depends on the following factors:

- Model
- Order
- National version
- Availability

Your vehicle may therefore differ from that shown in the descriptions and illustrations in individual cases.

Mercedes-Benz reserves the right to introduce changes in the following areas:

- Design
- Equipment
- Technical features

The following documents are components of the vehicle:

- Digital Operator's Manual
- Printed Operator's Manual
- Maintenance Booklet
- Supplementary manuals relating to specific equipment
- Supplementary documents

Keep these documents in the vehicle at all times. Ensure that all documents are in the vehicle or passed on in the event of sale or rental.

Mercedes-Benz USA, LLC

Mercedes-Benz Canada, Inc.

A Mercedes-Benz Group AG Company

1185847609



---

<b>Symbols</b> .....	5	Fitting the license plate to the front license plate holder .....	25	<b>Children in the vehicle</b> .....	53
<b>At a glance</b> .....	6	National information for components relevant to radio regulation .....	25	Brief overview of most important points .....	53
Cockpit .....	6	Diagnostics connection .....	26	Important safety notes .....	53
Indicator and warning lamps (standard) .....	8	Qualified specialist workshop .....	27	Suitable child restraint systems for the transport of children .....	59
Indicator and warning lamps (widescreen cockpit) .....	10	Correct use of the vehicle .....	27	Securing the child restraint system .....	59
Overhead control panel .....	12	Notes for persons with electronic medical aids .....	28	Child safety locks .....	66
Door operating unit and seat adjustment .....	14	Problems with your vehicle .....	28	Occupant presence reminder .....	67
Emergencies and breakdowns .....	16	Reporting safety defects .....	29	<b>Opening and closing</b> .....	69
<b>Digital Operator's Manual</b> .....	18	Limited Warranty .....	29	SmartKey .....	69
Calling up the Digital Operator's Manual .....	18	QR code for rescue card .....	29	Doors .....	73
<b>General notes</b> .....	19	Data storage .....	30	Trunk .....	77
Protecting the environment .....	19	Copyright .....	34	Side windows .....	81
Mercedes-Benz Genuine Parts .....	19	<b>Occupant safety</b> .....	36	Sliding sunroof .....	85
Operator's Manual .....	20	Brief overview of the most important points .....	36	Anti-theft protection .....	89
Touch-sensitive controls .....	21	Information on the automatic functions of the restraint system .....	43	<b>Seats and stowing</b> .....	92
Mercedes me App .....	21	Purpose and function of the restraint system .....	46	Notes on the correct driver's seat position .....	92
Service and vehicle operation .....	22	Seat belts .....	52	Notes on grab handles .....	93
Operating safety .....	23	Airbags .....	52	Seats .....	93
				Steering wheel .....	103
				Easy entry and exit feature .....	104
				Memory function .....	106

---

Stowage areas .....	107	Parking .....	158	<b>Maintenance and care</b> .....	<b>273</b>
Sockets .....	115	Driving and driving safety systems .....	167	ASSYST PLUS service interval display .....	273
Wireless charging of the mobile phone and connection with the exterior antenna ....	116	Vehicle towing instructions .....	219	Maintenance Management .....	274
Installing/removing the floor mats .....	118			Telediagnosis .....	274
				Engine compartment .....	275
<b>Light and visibility</b> .....	<b>120</b>	<b>Driver's display</b> .....	<b>220</b>	Checking the brake lining thickness .....	281
Exterior lighting .....	120	Notes on the driver's display .....	220	Cleaning and care .....	282
Interior lighting .....	125	Operating the driver's display .....	220		
Windshield wiper and windshield washer system .....	126	Driver display menus .....	221		
Mirrors .....	128	Head-up Display .....	222		
		Vehicles with a 48 V on-board electrical system .....	224	<b>Breakdown assistance</b> .....	<b>291</b>
		Overview of status indicators on the driver display .....	224	Emergency .....	291
				Flat tire .....	293
<b>Climate control</b> .....	<b>132</b>			Battery (vehicle) .....	299
Overview of climate control systems .....	132	<b>MBUX multimedia system</b> .....	<b>226</b>	Tow starting or towing away .....	305
Operating the climate control system .....	132	Overview and operation .....	226	Electrical fuses .....	310
		System settings .....	236		
<b>Driving and parking</b> .....	<b>136</b>	Navigation and traffic .....	241	<b>Wheels and tires</b> .....	<b>314</b>
Driving .....	136	Telephone .....	252	Notes on noise or unusual handling char- acteristics .....	314
DYNAMIC SELECT .....	148	Mercedes me Apps .....	255	Notes on regularly inspecting wheels and tires .....	314
Automatic transmission .....	150	Mercedes-Benz emergency call system .....	262	Notes on snow chains .....	315
Function of the 4MATIC .....	156	Radio & media .....	266	Tire pressure .....	315
Refueling .....	156	Sound settings .....	272	Loading the vehicle .....	322
				Tire labeling .....	326

## 4 Contents

---

Definition of terms for tires and loading .....	332
Changing a wheel .....	334
Emergency spare wheel .....	343

---

<b>Technical data .....</b>	<b>346</b>
Notes on technical data .....	346
Vehicle electronics .....	346
Radio regulations .....	348
Vehicle identification plate, VIN and engine number overview .....	348
Operating fluids .....	350
Vehicle data .....	356

---

<b>Display messages and warning/indicator lamps .....</b>	<b>358</b>
Display messages .....	358
Warning and indicator lamps .....	411

---

<b>Index .....</b>	<b>429</b>
--------------------	------------

In this Operator's Manual, you will find the following symbols:

 **WARNING** Danger due to failure to observe the warning notices

Warning notices draw your attention to hazards that may endanger your health or life, or the health or life of others.

 Observe the warning notices.

 **ENVIRONMENTAL NOTE** Environmental damage due to failure to observe environmental notes

Environmental notes include information on environmentally responsible behavior or environmentally responsible disposal.

 Observe environmental notes.

 **NOTE** Damage to property due to failure to observe notes on material damage

Notes on material damage inform you of risks which may lead to your vehicle being damaged.

 Observe notes on material damage.

 These symbols indicate useful instructions or further information that could be helpful to you.

 Instruction

(→ page) Further information on a topic

**Display** Display in the central display

 Highest menu level, which is to be selected in the multimedia system





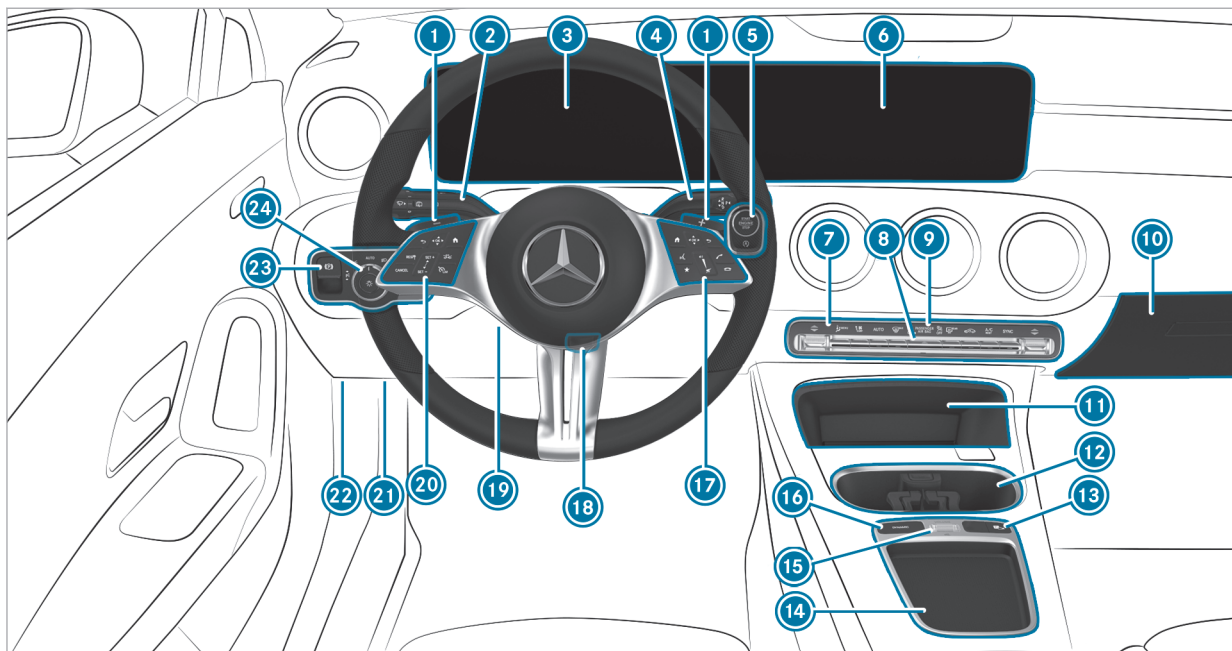



 Relevant submenus, which are to be selected in the multimedia system

\* Indicates a cause



Left-hand drive vehicles







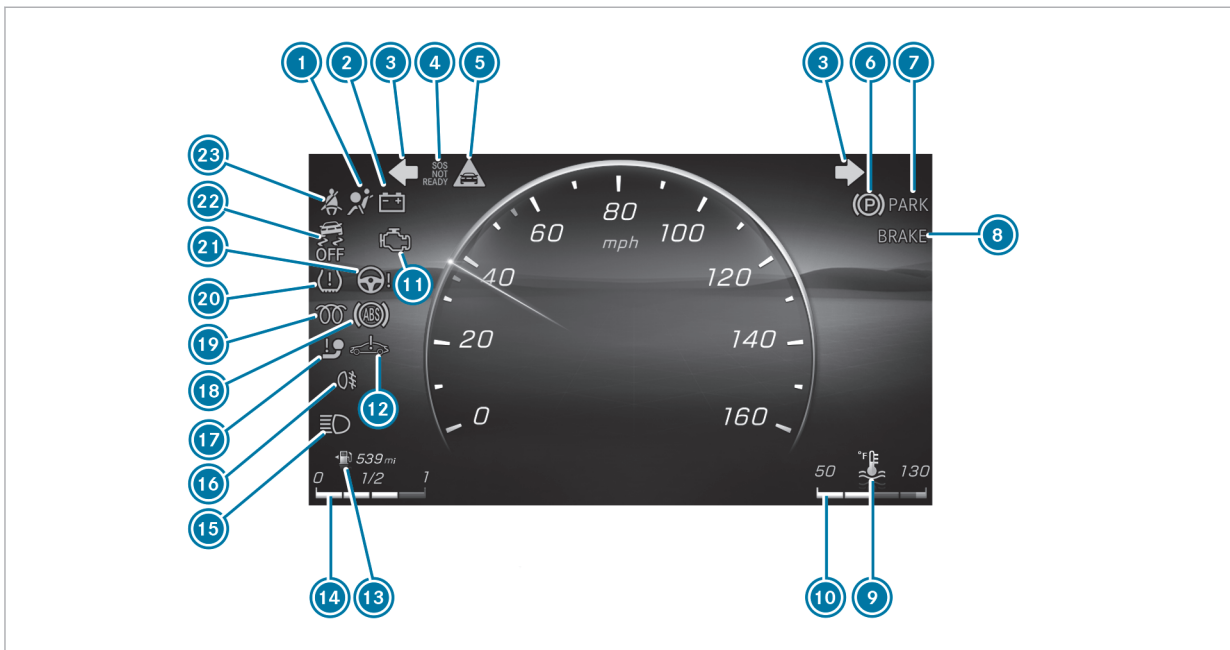























1	Steering wheel paddle shifters	→	153	 Switches the MBUX multimedia system on/off	→	226	
2	Combination switch	→	121	16	DYNAMIC SELECT button	→	149
3	Driver display	→	224	17	Control panel for the MBUX multimedia system	→	226
4	DIRECT SELECT lever	→	150	18	Adjusts the steering wheel	→	103
5	 Start/stop button	→	137	19	 Switches the steering wheel heater on/off	→	104
	 ECO start/stop function	→	145	20	Control panel:		
6	Central display	→	226		Driver display	→	224
7	Climate control systems	→	132		Cruise control	→	176
8	 Hazard warning light system	→	122		 Active Distance Assist DISTRONIC	→	180
9	PASSENGER AIR BAG indicator lamp	→	41	21	Diagnostics connection	→	26
10	Glove box	→	110	22	Opens the hood	→	275
11	Storage compartment	→	110	23	 Electric parking brake	→	163
12	Cup holder			24	Light switch	→	120
13	 Active Parking Assist	→	214				
14	Stowage space						
15	 Controller for volume and switching sound on/off	→	226				

8 At a glance - Indicator and warning lamps (standard)









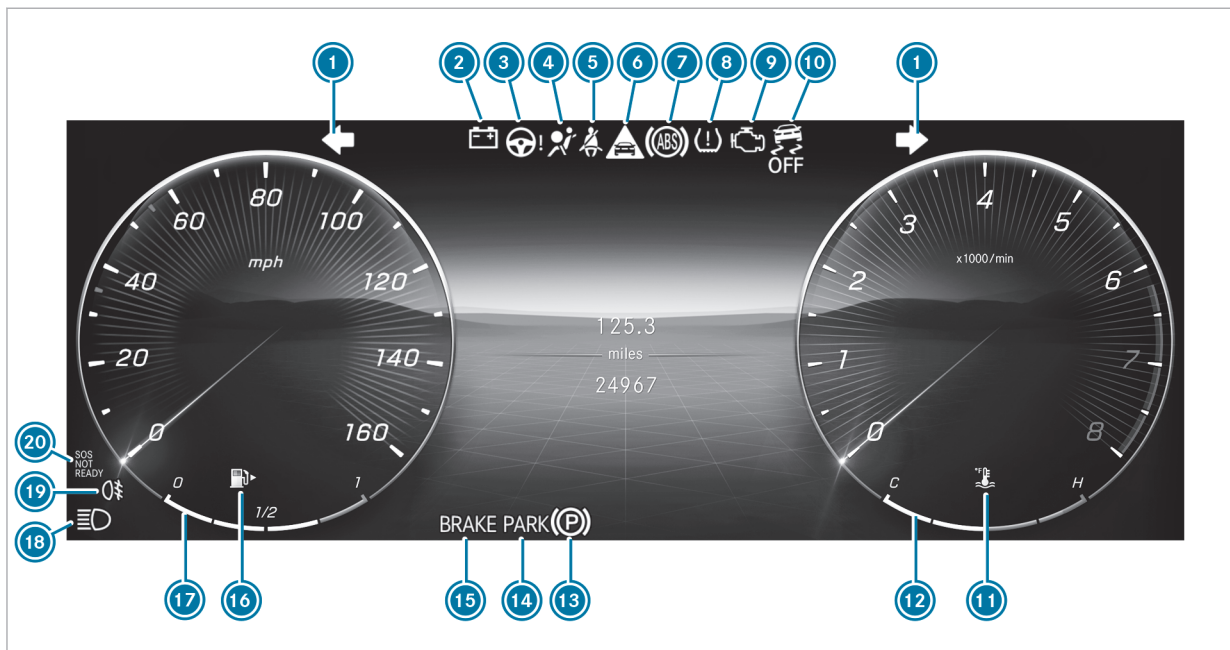

















Standard driver's display

1		Restraint system	→	413	11		Engine diagnostics	→	416
2		Electrical malfunction	→	416	12		System error		
3		Turn signal lights	→	121	13		Reserve fuel with fuel filler flap location indicator	→	416
4		Mercedes-Benz emergency call system	→	426	14		Fuel level		
5		Distance warning	→	423	15		High-beam headlamps	→	121
6		Electric parking brake (yellow)	→	420			Low beam	→	120
7		Electric parking brake (red)	→	420			Side lights	→	120
		USA only			16		Rear fog light	→	121
		Canada only			17		Indicator lamp inoperative		
8		Brakes (red)	→	420	18		ABS	→	423
		USA only			19		Indicator lamp inoperative		
		Canada only			20		Tire pressure monitoring system	→	427
		Recuperative Brake System, USA only	→	420	21		Power steering	→	415
		Brakes (yellow), Canada only	→	420	22		ESP® OFF	→	423
9		Coolant temperature	→	416			ESP®	→	423
10		Coolant temperature display			23		Seat belt	→	413

10 At a glance - Indicator and warning lamps (widescreen cockpit)









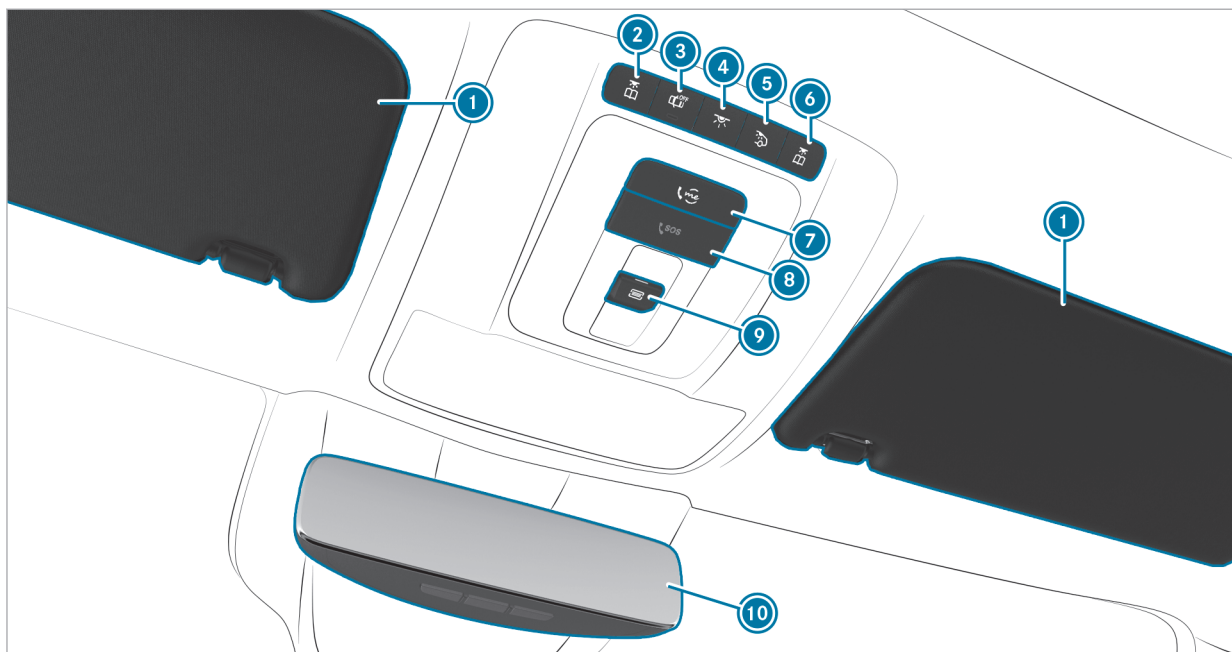

Widescreen cockpit driver's display

1		Turn signal lights	→	121			
2		Electrical malfunction	→	416			
3		Power steering	→	415			
4		Restraint system	→	413			
5		Seat belt	→	413			
6		Distance warning	→	423			
7		ABS	→	423			
8		Tire pressure monitoring system	→	427			
9		Engine diagnosis	→	416			
10		ESP® OFF	→	423			
		ESP®	→	423			
11		Coolant temperature					
12		Coolant temperature display					
13		Electric parking brake (yellow)	→	420			
14		Electric parking brake (red)	→	420			
		PARK					USA only
							Canada only
15		Brakes (red)	→	420			
		BRAKE					USA only
							Canada only
		RBS					Recuperative Brake System, USA only
			→	420			Brakes (yellow), Canada only
16		Reserve fuel with fuel filler flap location indicator	→	416			
17		Fuel level					
18		High beam	→	121			
		Low beam	→	120			
		Standing lights	→	120			
19		Rear fog light	→	121			
20		Mercedes-Benz emergency call system	→	426			

## 12 At a glance - Overhead control panel







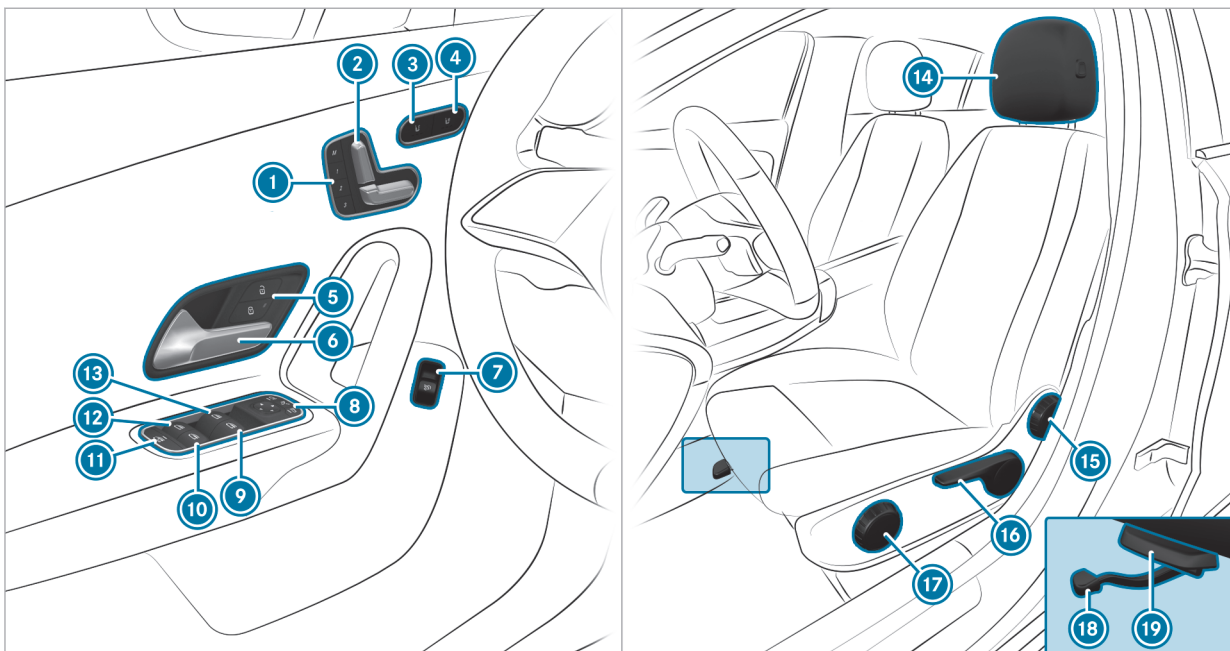







1	Sun visors		
2	 Switches the left-hand reading lamp on/off	→	125
3	 Switches automatic interior lighting control on/off	→	125
4	 Switches the front interior lighting on/off	→	125
5	 Switches the rear interior lighting on/off	→	125
6	 Switches the right-hand reading lamp on/off	→	125
7	 me button	→	255
8	 SOS button	→	255
9	 Opens/closes the panorama roof with power tilt/sliding panel	→	85
	 Opens/closes the roller sunblind	→	85
10	Inside rear-view mirror	→	129



14 At a glance - Door operating unit and seat adjustment



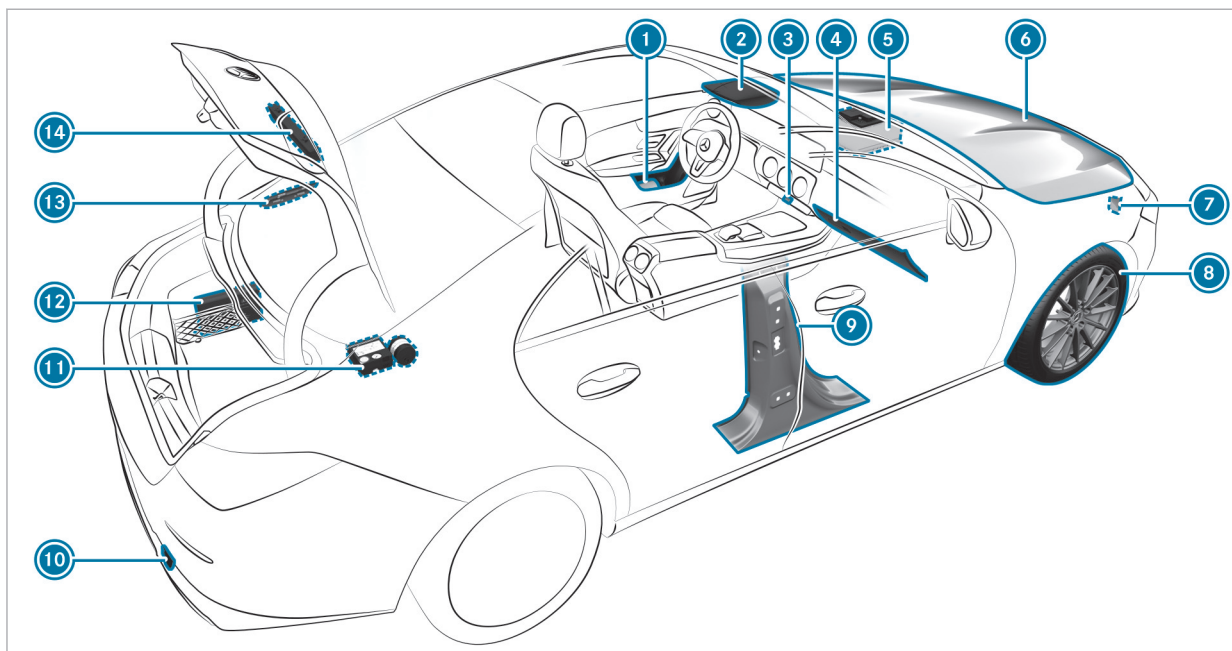

①	 Operates the memory function	→	106	⑪	 Child safety lock for the rear side windows	→	67
②	Adjusts the seats electrically	→	98	⑫	 Opens/closes the rear left side window	→	81
③	 Switches the seat heating on/off	→	101	⑬	 Opens/closes the left side window	→	81
④	 Mercedes-AMG vehicle only: switches the seat ventilation on/off	→	102	⑭	Adjusts the head restraints	→	99
⑤	  Locks/unlocks the vehicle	→	73	⑮	Adjusts the seat backrest inclination	→	95
⑥	Opens the door	→	73	⑯	Adjusts the seat height	→	95
⑦	 Opens/closes the trunk lid	→	77	⑰	Adjusts the seat cushion inclination	→	95
⑧	 Operates the outside mirrors	→	128	⑱	Adjusts the seat fore-and-aft position	→	95
⑨	 Opens/closes the right side window	→	81	⑲	Adjusts the seat cushion length	→	95
⑩	 Opens/closes the rear right side window	→	81				



1	Safety vests	→	291
2	 me button	→	255
	 SOS button	→	255
3	 Hazard warning light system	→	122
4	Stowage compartment for customer literature		
5	Jump-starting	→	303
6	To check and refill operating fluids	→	350
7	Tow-starting or towing away	→	306
8	Flat tire	→	293
9	B-pillar with:		

	QR code for accessing the rescue card	→	29
10	Tow-starting or towing away	→	306
11	TIREFIT kit	→	295
12	First-aid kit (soft sided)	→	293
13	Fuel filler flap with:		
	information label on fuel type	→	156
	Information label on tire pressure	→	317
	QR code for accessing the rescue card	→	29
14	Warning triangle	→	292

## Calling up the Digital Operator's Manual

Multimedia system:

→  » Settings » Info

» Operator's Manual

» Open Digital Operator's Manual

The Digital Operator's Manual describes the functions and operation of the vehicle and the multimedia system.

▶ Select one of the following menu items in the Digital Operator's Manual:

- **Quick start:** find the first steps towards adjusting your seat (driver's side).
- **Tips:** find information that prepares you for certain everyday situations with your vehicle.
- **Animations:** watch animations of the vehicle functions.
- **Messages:** receive additional information about the messages in the driver's display.
- **Language:** select the language for the Digital Operator's Manual.

You can search for keywords using the search field **Search**, in order to find quick answers to questions about the operation of the vehicle.

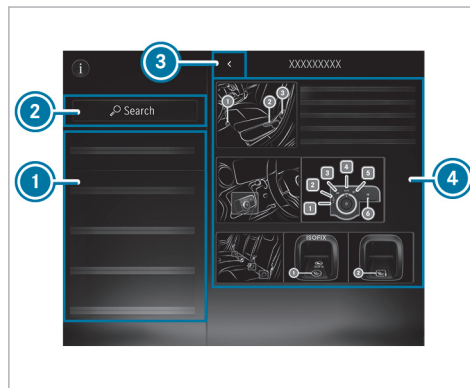

- 1 Menu
- 2 Search
- 3 Back
- 4 Contents section

Some sections in the Digital Operator's Manual, such as warning notes, can be expanded and collapsed.

**Additional methods of calling up the Digital Operator's Manual:**

**Driver's display:** call up brief information as display messages in the driver's display

**MBUX Voice Assistant:** call up via the voice control system

**Global search:** call up search results for contents of the Digital Operator's Manual in the home screen

For safety reasons, the Digital Operator's Manual is deactivated while driving.

## Protecting the environment

 **ENVIRONMENTAL NOTE** Environmental damage due to operating conditions and personal driving style

The pollutant emission of the vehicle is directly related to the way you operate the vehicle.

Operate your vehicle in an environmentally responsible manner to help protect the environment. Please observe the following recommendations on operating conditions and personal driving style.

### Operating conditions:

- ▶ Make sure that the tire pressure is correct.
- ▶ Do not carry any unnecessary weight (e.g. roof luggage racks once you no longer need them).
- ▶ Adhere to the service intervals. A regularly serviced vehicle will contribute to environmental protection.

- ▶ Always have maintenance work carried out at a qualified specialist workshop.

### Personal driving style:

- ▶ Do not depress the accelerator pedal when starting the engine.
- ▶ Do not warm up the vehicle while stationary.
- ▶ Drive carefully and maintain a suitable distance from the vehicle in front.
- ▶ Avoid frequent, sudden acceleration and braking.
- ▶ Change gear in good time and use each gear only up to  $\frac{2}{3}$  of its maximum engine speed.
- ▶ Switch off the vehicle in stationary traffic, e.g. by using the ECO start/stop function.
- ▶ Drive in a fuel-efficient manner. Observe the ECO display for an economical driving style.

### Environmental issues and recommendations:

It is recommended that you re-use or recycle materials instead of just disposing of them.

The relevant environmental guidelines and regulations serve to protect the environment and must be strictly observed.

## Mercedes-Benz Genuine Parts

 **ENVIRONMENTAL NOTE** Environmental damage due to not using recycled reconditioned components

Mercedes-Benz AG offers recycled reconditioned components and parts with the same quality as new parts. The same entitlement from the Limited Warranty is valid as for new parts.

- ▶ Use recycled reconditioned components and parts from Mercedes-Benz AG.

**!** **NOTE** Impairment of the operating efficiency of the restraint systems from installing accessory parts or from repairs or welding

Air bags and Emergency Tensioning Devices, as well as control units and sensors for the restraint systems, may be installed in the following areas of your vehicle:

- doors
- door pillars
- sill
- seats
- cockpit
- instrument display
- center console
- lateral roof frame

- ▶ Do not install accessory parts such as audio systems in these areas.
- ▶ Do not carry out repairs or welding.

▶ Have accessories retrofitted at a qualified specialist workshop.

You could jeopardize the operating safety of your vehicle if you use parts, tires and wheels as well as accessories relevant to safety that have not been approved by Mercedes-Benz. Safety-critical systems (e.g. the brake system) may malfunction. Use only Mercedes-Benz Genuine Parts or parts of equal quality. Use only tires, wheels and accessory parts that have been specifically approved for your vehicle model.

Mercedes-Benz Genuine Parts are subject to strict quality inspections. Each part has been specially developed, manufactured or selected for Mercedes-Benz vehicles and adapted to them. Therefore, only Mercedes-Benz Genuine Parts should be used.

More than 300,000 different Mercedes-Benz Genuine Parts are available for Mercedes-Benz models.

All authorized Mercedes-Benz Service Centers maintain a supply of Mercedes-Benz Genuine Parts for necessary service and repair work. In

addition, strategically located parts delivery centers provide for quick and reliable parts service.

Always specify the vehicle identification number (VIN) (→ page 348) when ordering Mercedes-Benz Genuine Parts.

### Operator's Manual

This Operator's Manual and the Digital Operator's Manual in the vehicle describe the following models and the standard and special equipment for your vehicle:

- The models and the standard and special equipment available at the time of this Operator's Manual going to press.
- The models and the standard and special equipment only available in certain countries.
- The models and the standard and special equipment, which will only be available at a later date.

Note that your vehicle may not have all features described. This is also the case for systems relevant to safety. Therefore, the equipment on your

vehicle may differ from that in the descriptions and illustrations.

The original purchase agreement for your vehicle contains a list of the equipment in your vehicle at the time of delivery.

Should you have any questions concerning equipment and operation, please consult an authorized Mercedes-Benz Center.

**i** Please bear in mind that all the speed values stated in this Operator's Manual are approximate and are subject to a certain tolerance.

The Operator's Manual, Supplement, further supplementary documents and Maintenance Booklet are important documents and should be kept in the vehicle.

### Touch-sensitive controls

In addition to conventional switches and buttons, your vehicle is equipped with touch-sensitive controls.

These are located in the following areas of your vehicle:

- Roof and door control panel

- Climate control
- Steering wheel
- MBUX multimedia system

The controls have touch-sensitive user interface surfaces. You can control these surfaces by pressing or swiping to adjust settings or to trigger functions, for example.

The touch-sensitive interface on the touchscreen also provides haptic feedback in the form of pulses, vibrations or changes in the surface structure, for example.

You will receive haptic feedback in the following situations, for example:

- When pressing a button on the user interface
- When scrolling in a list or table
- When you reach a new area on the user interface, e.g. a pop-up window

When using touch-sensitive user interfaces, note the following points to avoid problems:

- Do not affix stickers or similar objects to the surfaces.

- Do not attach smartphone holders or other mountings to the surface of the central display.
- Keep the surfaces protected from moisture and wet conditions.
- Keep the surfaces free of dust and dirt (→ page 287).

Some touch-sensitive controls have both a symbol and integrated indicator lamps. Be sure to press on the symbol of the control element when using it.

### Mercedes me App

#### Notes about the on-demand feature

You can also activate various functions (on-demand feature) subsequently via Mercedes me after purchasing your vehicle.

Information is available at any authorized Mercedes-Benz Center.

## Activating on-demand feature using Mercedes me

### Requirements

- The vehicle has a wireless connection.
- The vehicle is linked to the Mercedes me user account.

### Ordering and activating on-demand feature

- ▶ Add the desired on-demand feature for the vehicle to the shopping basket in the Mercedes me Store.
- ▶ Complete the order.  
The on-demand feature is activated when operating the vehicle.

### Speeding up activation

- ▶ Switch the vehicle off and lock it.
- ▶ Unlock the vehicle after about two minutes and switch on the vehicle.  
The on-demand feature has been activated. For some features, a notification also appears in the vehicle's multimedia system.

If the activation was not successful, repeat the process.

## Service and vehicle operation

### Vehicle operation outside the USA or Canada

When you are abroad with your vehicle, observe the following points:

- service points or replacement parts may not be available immediately.
- unleaded fuel may not be available for vehicles with a catalytic converter. Leaded fuel may cause damage to the catalytic converter.
- the fuel may have an extremely low octane number. Unsuitable fuel can cause engine damage.

Some Mercedes-Benz models are available in Europe through our European Delivery Program. For more information, please consult an authorized Mercedes-Benz Service Center, or write to one of the following addresses:

#### **in the USA:**

Mercedes-Benz USA, LLC  
European Delivery Department  
One Mercedes-Benz Drive

Sandy Springs, GA 30328

#### **in Canada:**

Mercedes-Benz Canada, Inc.  
European Delivery Department  
98 Vanderhoof Avenue  
Toronto, Ontario M4G 4C9

### Maintenance

Your customer advisor confirms the service in the service report.

### Roadside Assistance

The Mercedes-Benz Roadside Assistance Program offers technical help in the case of a breakdown. Your calls to the toll-free Roadside Assistance Hotline are answered by our agents 24 hours a day, 365 days a year.

1-800-FOR-MERCEDES (1-800-367-6372) (USA)  
1-800-387-0100 (Canada)

You can find further information in the Mercedes-Benz Roadside Assistance Program brochure



(USA) or the "Roadside Assistance" section in the Service and Warranty booklet (Canada). You will find both in the vehicle document wallet.

### Change of address or change of ownership

In the event of a change of address, please send us the "Notification of address change" in the Service and Guarantee booklet or simply call the Mercedes-Benz Customer Assistance Center (USA) on the hotline number 1-800-FOR-MERCEdes (1-800-367-6372) or Customer Service (Canada) on 1-800-387-0100. We can then reach you in a timely fashion, if necessary.

If you sell your Mercedes, please leave all literature in the vehicle so that it is available to the next owner. If you have purchased a used vehicle, please send us the "Notice of Purchase of Used Car" in the Service and Guarantee booklet or simply call the Mercedes-Benz Customer Assistance Center (USA) at the hotline number 1-800-FOR-MERCEdes (1-800-367-6372) or Customer Service (Canada) at 1-800-387-0100.

### Possible danger due to substances hazardous to health

In compliance with Proposition 65 ("Prop65"), the following detachable label has been added to each vehicle sold in California:



### Operating safety

**⚠ WARNING** Risk of accident due to malfunctions or system failures

If you do not have the prescribed service/maintenance work or any required repairs car-

ried out, this could result in malfunctions or system failures.

- ▶ Always have the prescribed service and maintenance work or any required repairs carried out in a qualified specialist workshop.

**⚠ WARNING** Risk of accident or injury due to incorrect modifications on electronic component parts

Modification of electronic components, their software or wiring could impair their function and/or the function of other networked component parts or safety-relevant systems.

This can endanger the operating safety of the vehicle.

- ▶ Never tamper with the wiring and electronic component parts or their software.
- ▶ You should have all work on electrical and electronic components carried out at a qualified specialist workshop.

Observe the "On-board electronics" section in "Technical data".

**⚠ WARNING** Risk of fire caused by flammable material on hot exhaust system components

Flammable material such as leaves, grass or twigs may ignite if they come into contact with hot parts of the exhaust system.

- ▶ When driving on an unpaved road or off-road, check the vehicle underside regularly.
- ▶ In particular, remove trapped plant parts or other flammable material.
- ▶ If there is damage, consult a qualified specialist workshop immediately.

**! NOTE** Damage to the vehicle due to driving too fast and due to impacts to the vehicle underbody or suspension components

In the following situations, in particular, there is a risk of damage to the vehicle:

- The vehicle becomes grounded, e.g. on a high curb or an unpaved road
- The vehicle is driven too fast over an obstacle, e.g. a curb, speed bump or pothole
- A heavy object strikes the underbody or suspension components

In situations such as these, damage to the body, underbody, suspension components, wheels or tires may not be visible. Components damaged in this way can unexpectedly fail or, in the case of an accident, may no longer absorb the resulting force as intended.

If the underbody paneling is damaged, flammable materials such as leaves, grass or twigs can collect between the underbody and the

underbody paneling. These materials may ignite if they come into contact with hot parts of the exhaust system.

- ▶ Have the vehicle checked and repaired immediately at a qualified specialist workshop.

or

- ▶ If driving safety is impaired while continuing your journey, pull over and stop the vehicle immediately, while paying attention to road and traffic conditions, and contact a qualified specialist workshop.

#### Vehicles with a 48 V on-board electrical system

**⚠ DANGER** Risk of fatal injury by touching damaged high-voltage components

Vehicles with a 48 V on-board electrical system contain individual high-voltage components. These high-voltage components are under high voltage.

If you modify component parts of these high-voltage components or touch damaged component parts, you may be electrocuted.

High voltage components may be damaged in an accident, although the damage may not be visible.

- ▶ Never perform modifications to component parts of high-voltage components.
- ▶ Never touch damaged component parts of high-voltage components.
- ▶ Never touch component parts of high-voltage components after an accident.

Vehicles with a 48 V on-board electrical system contain high-voltage components. These components are marked with a high-voltage label:

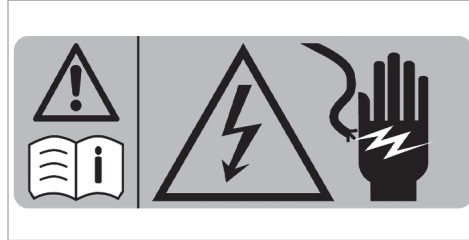

Example

All work on high-voltage components must be carried out at a qualified specialist workshop.

#### Fitting the license plate to the front license plate holder

**!** **NOTE** Malfunctions and system failures due to incorrect mounting of the license plate on the front license plate holder

If the license plate is incorrectly mounted on the front license plate holder, sensors, cam-

eras or driving and safety systems may malfunction or fail.

Observe the following points when mounting the license plate on the front license plate holder:

- ▶ Mount the license plate directly on the license plate holder without advertising media or other holders.
- ▶ Mount the license plate so that it does not protrude above or to the side of the license plate adapter.

#### National information for components relevant to radio regulation

##### Information on crossing national borders

You must observe the radio regulations for the country in which you are currently operating your vehicle.



USA: "Radio based devices of this vehicle comply with Part 15 of the FCC Rules. Operation is subject to the following two conditions: 1) These devices may not cause harmful interference, and 2) These devices must accept any interference received, including interference that may cause undesired operation. Changes or modifications not expressly approved by the party responsible for compliance could void the user's authority to operate the equipment."

Canada: "This vehicle contains licence-exempt transmitter(s)/receiver(s) that comply with Innovation, Science and Economic Development Canada's licence-exempt RSS(s). Operation is subject to the following two conditions: (1) These devices may not cause interference. (2) These devices must accept any interference, including interference that may cause undesired operation of the devices." "Les émetteurs/récepteurs dans ce véhicule sont conformes aux CNR d'Innovation, Sciences et Développement économique Canada applicables aux appareils radio exempts de licence. L'exploitation est autorisée aux deux conditions suivantes : 1) Ces appareils ne doivent pas produire de brouillage; 2) Ces appareils doivent

accepter tout brouillage radioélectrique subi, même si le brouillage est susceptible d'en compromettre le fonctionnement."

### Diagnostics connection

The diagnostics connection is a technical interface in the vehicle. It is used, for example, during repair and maintenance work or for reading out vehicle data in a specialist workshop. Diagnostic devices should therefore only be connected in a qualified specialist workshop.

**⚠ WARNING** Risk of accident due to connecting devices to the diagnostics connection

If you connect devices to the diagnostics connection of the vehicle, the function of vehicle systems and operating safety may be impaired.

- ▶ For safety reasons, we recommend that you use and connect only products approved by an authorized Mercedes-Benz Service Center.

**⚠ WARNING** Risk of accident due to objects in the driver's footwell

Objects in the driver's footwell may impede pedal travel or block a depressed pedal.

This jeopardizes the operating and road safety of the vehicle.

- ▶ Stow all objects in the vehicle securely so that they cannot get into the driver's footwell.
- ▶ Always install the floor mats securely and as prescribed in order to ensure that there is always sufficient room for the pedals.
- ▶ Do not use loose floor mats and do not place floor mats on top of one another.

**! NOTE** Battery discharging from using devices connected to the diagnostics connection

Using devices at the diagnostics connection drains the battery.

- ▶ Check the charge level of the battery.

- ▶ If the charge level is low, charge the battery, e.g. by driving a considerable distance.

Please also note the information about the 12 V battery and short-distance trips in the "Driving and Parking" chapter (→ page 140).

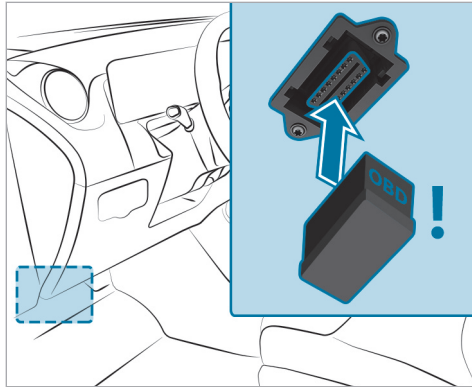

Connecting and using another device with the diagnostics connection can have the following effects:

- Malfunctions in the vehicle system
- Permanent damage to vehicle components

Please refer to the warranty terms and conditions for this matter.

Moreover, connecting equipment to the diagnostics connection can lead to emissions monitoring information being reset, for example. This may lead to the vehicle failing to meet the requirements of the next emissions inspection during the main inspection.

#### Qualified specialist workshop

An authorized Mercedes-Benz Service Center is a qualified specialist workshop. It has the necessary special skills, tools and qualifications to correctly carry out the work required on your vehicle. This particularly applies to safety-relevant work.

For the following, always have your vehicle checked at an authorized Mercedes-Benz Service Center:

- Safety-relevant work
- Service and maintenance work
- Repair work
- Modifications as well as installations and conversions
- Work on electronic components
- **Vehicles with 48 V on-board electrical system:** work on the high-voltage component of the 48 V on-board electrical system

Mercedes-Benz recommends a Mercedes-Benz Service Center.

#### Correct use of the vehicle

If you remove any warning stickers, you or others could fail to recognize certain dangers. Leave warning stickers in position.

Observe the following information in particular when driving your vehicle:

- the safety notes in this Operator's Manual, vehicle-specific supplements and further supplementary documents
- technical data for the vehicle
- traffic laws and regulations of the country you are currently driving in
- laws pertaining to motor vehicles and safety standards of the country you are currently driving in
- radio regulatory requirements of the country you are currently driving in

#### Notes for persons with electronic medical aids

Mercedes-Benz AG cannot, despite carefully developing vehicle systems, completely rule out the interaction of vehicle systems with electronic medical aids such as cardiac pacemakers.

In addition, there are components installed in the vehicle that, regardless of the operating status of the vehicle, can generate magnetic fields on a par with permanent magnets. These fields can be

found, for example, in the area around the multimedia and sound system or also in the area of the seats, depending on the vehicle equipment.

For this reason, the following can occur in isolated cases, depending on the aids used:

- Medical aids malfunctioning
- Adverse health effects

Observe the notes and warnings of the manufacturer of the medical aids; if in doubt, contact the device manufacturer and/or your doctor. If there is continuing uncertainty concerning the possibility of medical aids malfunctioning, Mercedes-Benz AG recommends using only few electrical vehicle systems and/or maintaining a distance from the components.

Only have repairs and maintenance work in the area of the following components carried out at a qualified specialist workshop:

- Vehicle components carrying live voltage
- Transmission antenna
- Multimedia system and sound system

If you have any queries or suggestions, consult a qualified specialist workshop.

#### Problems with your vehicle

If you should experience a problem with your vehicle, particularly one that you believe may affect its safe operation, we urge you to contact an authorized Mercedes-Benz Center immediately to have the problem diagnosed and rectified. If the problem is not resolved to your satisfaction, please discuss the problem again with an authorized Mercedes-Benz Center or, if necessary, contact us at one of the following addresses:

##### In the USA:

Mercedes-Benz USA, LLC  
Customer Assistance Center  
One Mercedes-Benz Drive  
Sandy Springs, GA 30328

##### In Canada:

Mercedes-Benz Canada, Inc.  
Customer Relations Department  
98 Vanderhoof Avenue

Toronto, Ontario M4G 4C9

### Reporting safety defects

#### USA only:

The following text is published as required of manufacturers under Title 49, Code of U.S. Federal Regulations, Part 575 pursuant to the “National Traffic and Motor Vehicle Safety Act of 1966”.

If you believe that your vehicle has a defect which could cause a crash or could cause injury or death, you should immediately inform the National Highway Traffic Safety Administration (NHTSA) in addition to notifying Mercedes-Benz USA, LLC.

If NHTSA receives similar complaints, it may open an investigation, and if it finds that a safety defect exists in a group of vehicles, it may order a recall and remedy campaign. However, NHTSA cannot become involved in individual problems between you, your dealer, or Mercedes-Benz USA, LLC.

To contact NHTSA, you may call the Vehicle Safety Hotline toll-free at 1-888-327-4236 (TTY: 1-800-424-9153) ; go to <https://www.safercar.gov>; or write to: Administrator, NHTSA, 400

Seventh Street, SW., Washington, DC 20590, USA.

You can also obtain other information about motor vehicle safety from <https://www.safercar.gov>.

#### Canada only:

The following text is published as required of manufacturers under subsection 18.4 (4) of the Motor Vehicle Safety Regulations.

If you believe that your vehicle has a defect which could cause a crash or could cause injury or death, you should immediately inform Transport Canada in addition to notifying Mercedes-Benz Canada Inc.

If Transport Canada received similar complaints, it may open an investigation, and if it finds that a safety defect exists in a group of vehicles, it may order a recall and remedy campaign. However, Transport Canada cannot become involved in individual problems between you, your dealer, or Mercedes-Benz Canada Inc.

To contact Transport Canada, you may call the Defect Investigations and Recalls Division toll-free in Canada at 1-800-333-0510 or 819-994-3328 in the Gatineau-Ottawa area or internationally;

may also go to the following websites for more information:

- English: <https://www.tc.gc.ca/recalls>
- French: <https://www.tc.gc.ca/rappels>

### Limited Warranty

**!** **NOTE** Damage to the vehicle arising from violation of these operating instructions.

Damage to the vehicle can arise from violation of these operating instructions.

This damage is not covered either by the Mercedes-Benz implied warranty or by the New- or Used-Vehicle Warranty.

▶ Follow the instructions in these operating instructions on proper operation of your vehicle as well as on possible vehicle damage.

### QR code for rescue card

QR codes are attached in the fuel filler flap and on the opposite side on the B-pillar. In the event of

an accident, rescue services can use the QR code to quickly find the appropriate rescue card for your vehicle. The current rescue card contains the most important information about your vehicle (e.g. the routing of the electric lines) in compact form.

Further information can be obtained at <https://www.mercedes-benz.de/qr-code>

## Data storage

### Data processing in the vehicle

#### Electronic control units

There are electronic control units installed in your vehicle. Control units process data that they e.g. receive from vehicle sensors, generate themselves or exchange among themselves. Some control units are required for the safe operation of your vehicle. For example, some assist you when you are driving, such as driver assistance systems, while others enable convenience or infotainment functions.

The following provides you with general information regarding data processing in the vehicle.

Additional information on what specific data is collected, stored and transmitted to third parties for what purpose in your vehicle can be found in the notes on the functional features in question in the respective operating instructions. These are also available online and, depending on the equipment, digitally in the vehicle.

#### Personal data

Each vehicle is marked with a unique vehicle identification number. Depending on the country, this vehicle identification number can be used by, for example, government authorities to determine the identity of the owner. There are other possibilities for using data collected from the vehicle to identify the owner or driver, such as the license plate number.

The data generated or processed by control units may therefore be personal or, in certain circumstances, become personal. Depending on which vehicle data are available, it may be possible to make inferences about, for example, your driving behavior, your location, your route or your use patterns.

#### Legal requirements for the disclosure of data

If legal regulations exist, manufacturers are generally obligated to release data stored by the manufacturer to the necessary extent in individual cases at the request of state authorities. This may be the case during the investigation of a criminal offense, for example.

Within the framework of applicable law, state authorities are also authorized to take data readouts from vehicles themselves in specific cases. In the event of an accident, for example, information readouts can be taken from the air bag control unit to help to establish what happened.

#### Operating data in the vehicle

Control units process data to operate the vehicle.

This includes the following data, for example:

- Vehicle status information such as speed, longitudinal acceleration, lateral acceleration, number of wheel revolutions or the fastened seat belts indicator
- Ambient conditions, such as temperature, rain sensor or distance sensor



As a rule, this data is volatile, is not stored beyond the operating time and is processed only in the vehicle itself. Control units (e.g. the vehicle key) often contain data memories. These are used to temporarily or permanently document information about the vehicle's operating state, component stress, maintenance requirements or technical events and malfunctions.

Depending on the technical equipment, the following data will be stored:

- Operating status of system components (e.g. fill levels, tire pressure, battery status)
- Malfunctions or faults in important system components (e.g. lights, brakes)
- System reactions in special driving situations (e.g. air bag deployment, the intervention of stability control systems)
- Information on events leading to vehicle damage

In special cases, it may be necessary to store data that would otherwise only be volatile. This may be the case if the vehicle has detected a malfunction, for example.

If you use services such as repair services or maintenance work, stored operational data readouts can be taken and used together with the vehicle identification number, where necessary. Readouts can be taken by service network employees such as workshops and manufacturers, or third parties, such as breakdown services. The same is true in the case of warranty claims and quality assurance measures.

The readout will usually be taken via the diagnostics connection in the vehicle, which is required by law. The operating data readout taken documents technical conditions of the vehicle or individual components and helps to diagnose malfunctions, meet warranty obligations and improve quality. This data, particularly information on component stress, technical events, operating errors and other malfunctions, will be transmitted to the manufacturer for this purpose together with the vehicle identification number if necessary. In addition, the manufacturer is subject to product liability. For this reason, the manufacturer also uses operational data from the vehicle for e.g. recalls. This data can also be used to check customer claims for warranty and guarantee.

Fault memories in the vehicle can be reset by a service outlet or at your request as part of repair or maintenance work.

### Comfort and infotainment functions

You can save comfort settings and individualization in the vehicle and change or reset them at any time.

Depending on the vehicle equipment, this includes the following settings, for example:

- Seat positions and steering wheel positions
- Suspension tuning and climate control settings
- Custom settings (e.g. interior lighting)

You can incorporate data into the vehicle's infotainment functions yourself as part of the selected equipment.

Depending on the vehicle equipment, this includes the following data, for example:

- Multimedia data (e.g. music, films or photos for playback in an integrated multimedia system)

- Address book data for use in conjunction with an integrated hands-free system or an integrated navigation system
- Navigation destinations that have been entered
- Data about the use of internet services

This data for comfort and infotainment functions can be saved locally in the vehicle or stored on a device that you have connected to the vehicle (e.g. smartphone, USB flash drive or MP3 player). If you have entered data yourself, you can delete it at any time.

The transfer of this data out of the vehicle will take place exclusively at your request. This applies in particular when you are using online services according to the settings you have selected.

### **Smartphone integration (e.g. Android Auto or Apple CarPlay®)**

If your vehicle is equipped appropriately, you can connect your smartphone or another mobile device to the vehicle. You will then be able to control them using the controls integrated in the vehicle. The smartphone's picture and sound can be

output via the multimedia system. Specific items of information will also be transferred to your smartphone. Depending on the type of integration, this may include position data, day/night mode and other general vehicle statuses. Please refer to the vehicle Operator's Manual / infotainment system operating instructions for further information.

This integration allows the use of selected smartphone apps (e.g. navigation apps, music player apps). There will be no further interaction between your smartphone and the vehicle; in particular, vehicle data will not be directly accessible. The type of additional data processing is determined by the provider of the app being used. Whether you can configure settings for it and, if so, which ones, depend on the app and your smartphone's operating system.

### **Online services**

---

#### **Wireless network connection**

If your vehicle has a wireless network connection, it enables data to be exchanged between your vehicle and additional systems. The wireless net-

work connection is made possible by the vehicle's own transmitter and receiver or by a mobile end device that you have brought into the vehicle, for example, a smartphone. Online functions can be used via the wireless network connection. This includes online services and applications/apps provided to you by the manufacturer or by other providers.

#### **Manufacturer's services**

Regarding the manufacturer's online services, the individual functions are described by the manufacturer in a suitable place, for example, in the Operator's Manual or on the manufacturer's website, where the relevant data protection information is also given. Personal data may be used for the provision of online services. Data is exchanged via a secure connection, such as the manufacturer's designated IT systems. Any personal data which is collected, processed and used, other than for the provision of services, is done so exclusively on the basis of legal permission. This is the case, for example, for a legally prescribed emergency call system, a contractual agreement or when consent has been given.

You can have services and functions, some of which are subject to a fee, activated or deactivated. This excludes legally prescribed functions and services, such as an emergency call system.

### Third-party services

If you use online services from other providers (third parties), these services are the responsibility of the provider in question and subject to that provider's data protection conditions and terms of use. As a general rule, the manufacturer has no influence on the content exchanged.

For this reason, when services are provided by third parties, please ask the service provider in question for information about the type, extent and purpose of the collection and use of personal data.

### Data protection rights

Depending on your country or the equipment and range of functions of your vehicle as well as the services you use and the services on offer, you are entitled to different data protection rights. Further information on data protection and your data protection rights can either be found on the

manufacturer's website or you will receive this information as part of the various services and service offers. There you will also find the contact information for the manufacturer and its data protection officers.

At a workshop, for example, with the support of a specialist and possibly for a fee, you can have data read out which is stored only locally in the vehicle.

### MBUX multimedia system/Mercedes me connect

If the vehicle is equipped with the MBUX multimedia system or Mercedes me connect, additional data about the vehicle's operation, the use of the vehicle in certain situations, and the location of the vehicle may be compiled by the MBUX multimedia system or Mercedes me connect.

For additional information, please refer to the "MBUX multimedia system" section and/or the Mercedes me connect Terms and Conditions.

### Event data recorder

USA only:

This vehicle is equipped with an event data recorder (EDR). The main purpose of an EDR is to record, in certain crash or near crash-like situations, such as an air bag deployment or hitting a road obstacle, data that will assist in understanding how a vehicle's systems performed. The EDR is designed to record data related to vehicle dynamics and safety systems for a short period of time, typically 30 seconds or less.

The EDR in this vehicle is designed to record such data as:

- How various systems in your vehicle were operating;
- Whether or not the driver and passenger safety belts were buckled/fastened;
- How far (if at all) the driver was depressing the accelerator and/or brake pedal; and,
- How fast the vehicle was traveling.

These data can help provide a better understanding of the circumstances in which crashes and injuries occur. NOTE: EDR data are recorded by your vehicle only if a non-trivial crash situation occurs; no data are recorded by the EDR under

normal driving conditions and no personal data (e.g., name, gender, age, and crash location) are recorded. However, other parties, such as law enforcement could combine the EDR data with the type of personally identifying data routinely acquired during a crash investigation.

To read data recorded by an EDR, special equipment is required, and access to the vehicle or the EDR is needed. In addition to the vehicle manufacturer, other parties, such as law enforcement, that have the special equipment, can read the information if they have access to the vehicle or the EDR.

EDR data may be used in civil and criminal matters as a tool in accident reconstruction, accident claims, and vehicle safety. Since the Crash Data Retrieval CDR tool that is used to extract data from the EDR is commercially available, Mercedes-Benz USA, LLC („MBUSA“) expressly disclaims any and all liability arising from the extraction of this information by unauthorized Mercedes-Benz personnel.

MBUSA will not share EDR data with others without the consent of the vehicle owners or, if the vehicle is leased, without the consent of the les-

see. Exceptions to this representation include responses to subpoenas by law enforcement; by federal, state or local government; in connection with or arising out of litigation involving MBUSA or its subsidiaries and affiliates; or, as required by law.

Warning: The EDR is a component of the Restraint System Module. Tampering with, altering, modifying or removing the EDR component may result in a malfunction of the Restraint System Module and other systems.

State laws or regulations regarding EDRs that conflict with federal regulation are pre\empted. This means that in the event of such conflict, the federal regulation governs. As of Dec 2016, 17 states have enacted laws relating to EDRs.

### Copyright

#### Free and open source software

Information on licenses for free and open-source software used in your vehicle can be found on the data carrier in your vehicle document wallet and with updates on the following website:

<https://www.mercedes-benz.com/opensource>

#### Registered trademarks



- Bluetooth® is a registered trademark of Bluetooth SIG, Inc.
- DTS™ is a registered trademark of DTS, Inc.
- Dolby® and MLP™ are registered trademarks of DOLBY Laboratories.
- ESP® and PRE-SAFE® are registered trademarks of Mercedes-Benz Group AG.
- HomeLink® is a registered trademark of Genetex Corporation.
- iPod® and iTunes® are registered trademarks of Apple Inc.
- Burmester® is a registered trademark of Burmester Audiosysteme GmbH.
- Microsoft® and Windows Media® are registered trademarks of Microsoft Corporation.
- SiriusXM® is a registered trademark of Sirius XM Radio Inc.

- HD Radio™ is a registered trademark of iBiquity Digital Corporation.
- Gracenote® is a registered trademark of Gracenote, Inc.
- ZAGAT Survey® and related brands are registered trademarks of Zagat Survey, LLC.

## Brief overview of the most important points

### Basic information

Make sure that the following prerequisites in particular have been met so that the components of the restraint system are able to provide the intended level of protection:

- Sit correctly (→ page 37).
- Fasten the seat belt correctly (→ page 38).
  - Function of the seat belt warning lamp  (→ page 40).
  - Function of the rear seat belt status display (→ page 40).
- The restraint system warning lamp  has gone out after the self-test (→ page 39).
- The PASSENGER AIR BAG indicator lamps display the correct status for the front passenger air bag (→ page 41).

### Helping you to understand clearly

The "Occupant safety" chapter includes information on equipment, functions and behaviors that

contribute directly to the safety of vehicle occupants.

The information is structured as follows:

- **Brief overview of the most important points:** this chapter provides an overview of the relationship between the restraint system and the correct behavior of all vehicle occupants.
- **Specific information:** in further sections of the "Occupant safety" chapter, you can find specific information on the equipment and functions of the restraint system.
- **Index:** you can also find certain topics in this Operator's Manual using the index.

The "Occupant safety" chapter does not provide information on topics including the following:

- Children in the vehicle (→ page 53)
- Driving and driving safety systems (→ page 167)
- Stowage areas (→ page 107)

### Defining generic terms clearly

The following generic terms are used in this Operator's Manual:

- **Occupant safety:** comprises the components and system functions that help to minimize, as much as possible, the stresses and consequences for vehicle occupants caused by an accident.
- **Restraint system:** comprises those components that, along with the vehicle structure, help prevent vehicle occupants from potentially coming into contact with parts of the vehicle interior. The seat belts and air bags, for example, are components of the restraint system.
- **Child restraint system:** you can find all information on this topic in the chapter "Children in the vehicle" (→ page 53).

### Be diligent

For the components of the restraint system to provide the intended level of protection, it is essential for your posture to be correct and for the seat belt to be fastened correctly.

Bear in mind that negligence when adopting your sitting position and fastening your seat belt may have serious consequences. Be diligent and make sure that all vehicle occupants are sitting correctly and have fastened their seat belts properly before starting every journey.

### Information on the correct seat position

The seat position must be correct in order for the components of the restraint system to provide the intended level of protection.

The seat position influences both the protection provided by the seat belt and the additional protection provided by the air bag.

The correct seat position with an almost upright posture and a correctly fastened seat belt also reduce the risk posed by the air bag when it is deployed.

When choosing the seat, take note of the available space. When you are sitting with the right posture in a nearly upright position, your head should not touch the roof.

#### **⚠ WARNING** Risk of injury or death due to an incorrect seat position

If you deviate from the correct seat position, the air bag cannot provide its intended protective function.

Each vehicle occupant must make sure of the following.

- ▶ Put the seat in the correct position.
- ▶ Fasten seat belts correctly. Pregnant women must take particular care to ensure that the lap belt never lies across the abdomen.
- ▶ Observe the following information.

In order for the restraint system to provide the intended level of protection, observe the following information:

- Before starting your journey, adjust your seat correctly (→ page 92).

When doing so, make sure you are able to fasten your seat belt correctly. The shoulder belt strap must be routed forward from the seat belt outlet over the center of your shoulder.

- Keep your distance from the air bags, especially the front air bags. Set the driver's seat and front passenger seat as far back as possible while making sure the seat belt is fastened correctly.
- If persons are sitting on the rear seats, vehicle occupants should maintain a sufficient distance to the parts of the vehicle interior in front of them.
- Make sure there are no people, animals or objects between the vehicle occupants and an air bag.
- If you are the driver, observe the following information on the correct position of the driver's seat (→ page 92).

Hold the steering wheel only by the steering wheel rim. This allows the driver's air bag to fully deploy.

- Assume a nearly upright position, with your buttocks as far back as possible in the gap between the seat cushion and seat backrest.

This ensures that your back lies as flat and firmly as possible against the seat backrest.

- While driving, do not lean forward and do not lean against the door or side window. You may otherwise be in the deployment area of the air bags.
- Sit with your feet resting on the floor, if possible. Your thighs are slightly supported by the seat cushion

Do not put your feet up on the cockpit, for example. Your feet may otherwise be in the deployment area of the air bag.

- Fasten the seat belt correctly.

### Notes on wearing the seat belt correctly

Always fasten your seat belt correctly before starting a journey. A seat belt can provide the best level of protection only if it is worn correctly.

**⚠ WARNING** Risk of injury or death due to incorrectly fastened seat belt

If the seat belt is not worn correctly, it cannot perform its intended protective function.

In addition, an incorrectly fastened seat belt can also cause injuries, for example, in the event of an accident or when braking or changing direction suddenly.

- ▶ Always ensure that all vehicle occupants have their seat belts fastened correctly and are sitting properly.

**⚠ WARNING** Risk of injury or death when additional restraint systems are not used for persons with a smaller stature

Persons under 5 ft (1.50 m) tall cannot wear the seat belt correctly without a suitable additional restraint system.

- ▶ Always secure persons under 5 ft (1.50 m) tall in a suitable restraint system.

Each vehicle occupant must observe the following notes in particular:

- The seat belt must not be twisted:

- The shoulder belt strap must be routed forward from the seat belt outlet over the center of your shoulder.
- The shoulder belt strap should neither touch your neck nor be routed under your arm or behind your back.
- The lap belt must be routed as low down across the hips as possible.

In addition, push the lap belt down as far as possible across your hips and pull tight with the shoulder belt strap. Never route the lap belt across your abdomen.

Pregnant women must also take particular care with this.

- The shoulder belt strap and lap belt must fit snugly against the body after being tightened.
- Avoid wearing bulky clothing, e.g. a winter coat.
- Never route the seat belt across sharp, pointed, abrasive or fragile objects.
- Only one person should use each seat belt at any one time.



- Never secure objects with a seat belt if the seat belt is also being used by one of the vehicle's occupants.

Also ensure that no objects, e.g. a cushion, are ever placed between a person and the seat.

### Fastening seat belts

If the seat belt is pulled quickly or sharply, the seat belt retractor locks. The seat belt strap cannot be pulled out any further.

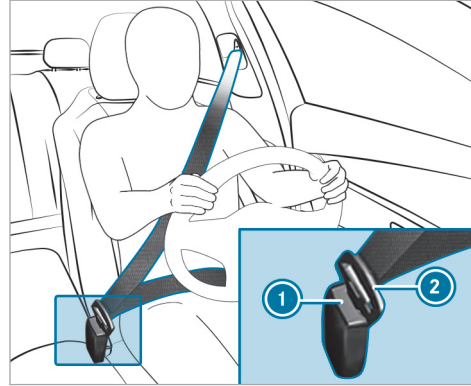

- ▶ Always engage seat belt tongue ② of the seat belt into seat belt buckle ① of the corresponding seat.

**!** **NOTE** Deployment of components of the restraint system when the front passenger seat is unoccupied and a seat belt is buckled

When the front passenger seat is unoccupied and the seat belt tongue of the seat belt is engaged in the seat belt buckle, components of the restraint system may deploy unnecessarily on the front passenger side, e.g. the Emergency Tensioning Device.



▶ Only buckle the seat belts as intended.

**i** Observe the information on the special seat belt retractor of the seat belt (→ page 61).

### Function of the restraint system warning lamp

When the vehicle is switched on, a self-test is performed, during which the restraint system warning lamp  lights up. It goes out no later than a few seconds after the vehicle is started. The components of the restraint system are then functional.

A malfunction has occurred in the restraint system if:

- the restraint system warning lamp  does not light up or lights up continuously when the vehicle is switched on.
- the restraint system warning lamp  lights up continuously or repeatedly during a journey.

If components of the restraint system have been deployed, the restraint system warning lamp  will light up continuously.

**⚠ WARNING** Risk of injury due to malfunctions in the restraint system

Components in the restraint system may be activated unintentionally or not deploy as planned in an accident.

- ▶ Have the restraint system checked and repaired immediately at a qualified specialist workshop.

Mercedes-Benz recommends that you have the vehicle towed to a qualified specialist workshop.

### Function of the seat belt warning lamp

The  seat belt warning lamp in the Instrument Display is a reminder that all vehicle occupants must wear their seat belts correctly.

The  seat belt warning lamp lights up for six seconds every time the vehicle is started.

In addition, a warning tone may sound.

When the driver's and front passengers doors are closed and the driver and front passenger have fastened their seat belts, the seat belt warning goes out.

In the following cases, the seat belt warning lights up during a journey if:

- The driver or front passenger is not wearing a seat belt and the following criteria apply:
  - The vehicle travels faster than 5 mph (9 km/h) for more than 20 seconds.
  - The vehicle travels faster than 15 mph (25 km/h) once.
- The driver or front passenger unfastens their seat belt while the vehicle is in motion.

### Function of the rear seat belt status display

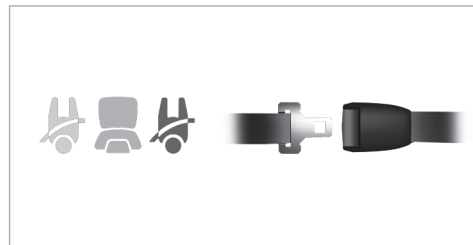

When the vehicle is switched on, the rear seat belt status indicator will inform you for a certain amount of time which rear seat belt is not fastened.

The status of the rear seat belt can be recognized by the color of the symbol on the driver's display:

- Grey: the seat belt tongue of a rear seat belt is not engaged in the seat belt buckle of the corresponding seat.
- Green: the seat belt tongue of a rear seat belt is engaged in the seat belt buckle of the corresponding seat.

Every vehicle occupant must always fasten their seat belt correctly before starting a journey.

- Red: a vehicle occupant in the rear passenger compartment has released the seat belt buckle using the release button and may not be properly secured.

If a vehicle occupant unfastens a seat belt in the rear passenger compartment, the rear seat belt status display will appear again.

In addition, a warning tone may sound.

### Function of the PASSENGER AIR BAG indicator lamps (front passenger air bag)



The PASSENGER AIR BAG indicator lamps display the status of the front passenger air bag.

If the front passenger seat is occupied or a child restraint system is installed on the front passenger seat, you must make sure, both before and during a journey, that the status of the front

passenger air bag is correct for the current situation.

**⚠ WARNING** Risk of potentially fatal injuries due to objects trapped under the front passenger seat

Objects trapped under the front passenger seat may interfere with the function of the automatic front passenger air bag shutoff or damage the system.

- ▶ Do not stow any objects under the front passenger seat.
- ▶ When the front passenger seat is occupied, ensure that no objects have become trapped beneath the front passenger seat.

**Self-test:** when the vehicle is switched on, both the PASSENGER AIR BAG ON and OFF indicator lamps light up simultaneously for several seconds.

After the self-test, you can determine the status of the front passenger air bag as follows:

- **Front passenger air bag disabled:** PASSENGER AIR BAG OFF lights up continuously.

The front passenger air bag will not be deployed in the event of an accident. If PASSENGER AIR BAG OFF is lit, no one may use the front passenger seat.

If a rearward-facing child restraint system is installed on the front passenger seat, PASSENGER AIR BAG OFF must be lit continuously.

- **Front passenger air bag enabled:** PASSENGER AIR BAG ON lights up for up to 60 seconds or both the PASSENGER AIR BAG ON and OFF indicator lamps do not light up.

The front passenger air bag may be deployed during an accident. If the front passenger air bag has this status, no rearward-facing child restraint system may be installed on the front passenger seat.

- **i** If you are driving with a child in the vehicle, observe the information in the chapter "Children in the vehicle" (→ page 53)

**⚠ WARNING** Risk of injury or death due to a disabled front passenger airbag

The front passenger airbag is disabled when the PASSENGER AIR BAG OFF indicator lamp is lit.

A person in the front passenger seat could then, for example, come into contact with the vehicle interior, especially if the person is sitting too close to the cockpit.

If the front passenger seat is occupied, always ensure that:

- The classification of the person in the front passenger seat is correct and the front passenger airbag is enabled or disabled in accordance with the person in the front passenger seat.
- The front passenger seat has been moved as far back as possible.
- The person is seated correctly.

▶ Both before and during the journey, ensure that the status of the front passenger airbag is correct.

**Malfunction of the automatic front passenger air bag shutoff**

The PASSENGER AIR BAG OFF indicator lamp and the restraint system indicator lamp  light up simultaneously.

In this case, no one may use the front passenger seat and no child restraint system may be installed on the front passenger seat.

Have the automatic front passenger air bag shutoff checked and repaired immediately at a qualified specialist workshop.

Be sure to also observe the following further related subjects:

- Child restraint system on the front passenger seat (→ page 57)

**Disabling or enabling the front passenger air bag**

The automatic front passenger air bag shutoff can activate or deactivate the front passenger air bag and front passenger knee bag according to the situation.

This happens automatically as a result of the classification of the person or child restraint system on the front passenger seat.

You cannot manually disable or enable the front passenger air bag.

Also observe the following information:

- The status of the front passenger air bag: see "Function of the PASSENGER AIR BAG indicator lamps" (→ page 41)
- Notes on using the front passenger seat: see "Information on automatic front passenger air bag shutoff" (→ page 43)
- If you are driving with a child in the vehicle, observe the chapter "Children in the vehicle" (→ page 53)

### Information on the child restraint system

When installing a child restraint system, observe the notes in "Children in the vehicle" (→ page 53).

### Notes on the child restraint system on the front passenger seat

**⚠ WARNING** Risk of injury or fatal injuries if the front passenger air bag is enabled

If the front passenger air bag is enabled, a child on the front passenger seat may be struck by the front passenger air bag in the event of an accident.

▶ NEVER use a rearward-facing child restraint system on a seat with an ENABLED FRONT AIR BAG. This can result in the DEATH of or SERIOUS INJURY to the CHILD.

Also pay particular attention to the notes on rearward-facing or forward-facing child restraint systems on the front passenger seat (→ page 57).

### Information on the automatic functions of the restraint system

#### Function of the automatic front passenger air bag shutoff

A person on the front passenger seat must observe the following information:

- Sit correctly (→ page 37).
- Fasten the seat belt correctly (→ page 38).

The automatic front passenger air bag shutoff can activate or deactivate the front passenger air bag and front passenger knee bag according to the situation.

Make sure you observe the following information:

- Status of the front passenger air bag: see "Function of the PASSENGER AIR BAG indicator lamps" (→ page 41).
- When installing a child restraint system on the front passenger seat, observe the vehicle-specific information (→ page 57).

Status of the front passenger air bag in relation to the stature of the person:

- **Front passenger air bag disabled:** PASSENGER AIR BAG OFF lights up continuously.

The front passenger air bag will not be deployed in the event of an accident. If PASSENGER AIR BAG OFF is lit, no one may use the front passenger seat.

- **Front passenger air bag enabled:** PASSENGER AIR BAG ON lights up for up to 60 seconds or until both the PASSENGER AIR BAG ON and OFF indicator lamps go out.

The front passenger air bag may be deployed during an accident. Observe the following information on the correct seat position (→ page 37).

**Vehicles with rear seats:** a person of smaller stature should use a rear seat.

### System limits

The front passenger air bag may otherwise be disabled by mistake, for example, in the following situation:

- The front passenger transfers their weight by supporting themselves on a vehicle armrest.
- The front passenger sits in such a way that their weight is raised from the seat surface.

**!** **NOTE** Deployment of components of the restraint system when the front passenger seat is unoccupied

In an accident, the components of the restraint system may deploy unnecessarily on the front passenger side if:

- There are heavy objects on the front passenger seat.
- The seat belt tongue is engaged in the seat belt buckle of the front passenger seat and the front passenger seat is unoccupied.

▶ Store objects in a suitable place.

▶ Only one person should use each seat belt at any one time.

Depending on the detected accident situation, the window air bag on the front passenger side may deploy. The air bag is deployed regardless of whether the front passenger seat is occupied.

### Function of PRE-SAFE® (anticipatory occupant protection)

PRE-SAFE® is able to detect certain critical driving situations and implement pre-emptive measures to protect the vehicle occupants.

PRE-SAFE® can implement the following measures independently of each other:

- Tightening the seat belts on the driver's seat and front passenger seat.
- Closing the side windows.
- **Vehicles with sliding sunroof:** closing the sliding sunroof.

- **Vehicles with memory function:** moving the front passenger seat to a more favorable seat position.
- **PRE-SAFE® Sound:** provided that the multimedia system is switched on, generating a brief noise signal to stimulate the innate protective mechanism of a person's hearing.

**!** **NOTE** Damage caused by objects in the footwell or behind the seat

The automatic adjustment of the seat position may result in damage to the seat and/or the object.

▶ Stow objects in a suitable place.

### Reverting the PRE-SAFE® system measures

If an accident did not occur, the pre-emptive measures that were taken will be reversed.

You will need to perform certain settings yourself.

- ▶ If the seat belt pre-tensioning is not reduced, move the seat backrest back slightly. The locking mechanism will release.

### Seat belt adjustment function

**Vehicles with PRE-SAFE®:** after you have fastened the seat belt of the front seat, it may adjust itself against your body by pulling at the shoulder until somewhat tight. Do not hold the seat belt tightly while it is adjusting.

This function is a reminder that all vehicle occupants must wear their seat belts correctly.

You can activate and deactivate the seat belt adjustment function using the multimedia system (→ page 45).

### Activating/deactivating seat belt adjustment via the multimedia system

Multimedia system:

→  ▶ Settings ▶ Vehicle  
▶ Occupant Protection

▶ Activate or deactivate **Seat adjustment**.

### Overview of the automatic measures after an accident

Depending on the type and severity of the accident, and depending on the vehicle's equipment, the following measures can be implemented, for example:

- automatic braking (post-collision brake)
- activating the hazard warning lights
- triggering an automatic emergency call (→ page 263)
- Switching off the engine

To start the vehicle again, switch the vehicle off and on once more (→ page 137). Depending on the type and severity of the accident, you may no longer be able to start the vehicle.

- switching off the fuel supply
- unlocking the vehicle doors
- lowering the side windows
- displaying the emergency guide in the central display
- switching on the interior lighting

### Function of the post-collision brake after an accident

Depending on the accident situation, the post-collision brake can minimise the severity of a further collision or even avoid it.

If an accident is detected, the post-collision brake can initiate automatic braking. When the vehicle has come to a standstill, the electric parking brake is automatically applied.

The driver can cancel automatic braking by taking the following actions:

- Braking more strongly than automatic braking
- Fully depressing the accelerator pedal with force

### Purpose and function of the restraint system

#### Overview of deployment situations (restraint system)

Make sure that the following prerequisites in particular have been met so that the components of the restraint system are able to provide the intended level of protection:

- Sit correctly (→ page 37).
- Fasten the seat belt correctly (→ page 38).
  - Function of the seat belt warning lamp (→ page 40).
  - Function of the rear seat belt status display (→ page 40).
- The restraint system warning lamp  is not lit up after the self-test (→ page 39).
- The PASSENGER AIR BAG indicator lamps display the correct status of the front passenger air bag (→ page 41).

Depending on the detected deployment situation, the components of the restraint system can be activated or deployed independently of each other:

- Emergency Tensioning Device: frontal impact, rear impact, side impact, rollover
- Driver's air bag, front passenger air bag: frontal impact
- Knee air bag: frontal impact
- Side impact air bag: side impact
- Window curtain air bag: side impact, rollover, frontal impact

The installation location of an air bag is identified by the AIRBAG symbol (→ page 52).

Observe the information on the function of the restraint system (→ page 46).

#### Information on how the restraint system works

How the restraint system functions depends on the severity of the impact detected and the apparent type of accident.



For more information about types of accidents, see "Overview of deployment situations" (→ page 46).

The activation thresholds for the components of the restraint system are determined based on the evaluation of the sensor values measured at various points in the vehicle. This process is pre-emptive in nature. The triggering/deployment of the components of the restraint system must take place in good time at the start of the collision.

Factors that can be seen and measured only after a collision has occurred cannot play a decisive role in air bag deployment. Nor do they provide an indication of air bag deployment.

The vehicle may be deformed significantly without an air bag being deployed. This is the case if only parts which are relatively easily deformed are affected and the rate of vehicle deceleration is not high. Conversely, an air bag may be deployed even though the vehicle suffers only minor deformation. If very rigid vehicle parts such as longitudinal members are hit, this may result in sufficiently high levels of vehicle deceleration.

Depending on the apparent type of accident and the detected deployment situation, Emergency Tensioning Devices and/or air bags can supplement the protection offered by a correctly worn seat belt.

When enabled, an air bag can provide additional protection for the respective vehicle occupant.

Potential protection provided by each air bag:

- Knee air bag: thigh, knee and lower leg
- Driver's air bag, front passenger air bag: head and ribcage
- Window air bag: head
- Side air bag: ribcage and pelvis

**!** NOTE Mercedes-AMG vehicles

- ▶ Observe the notes in the Supplement. You could otherwise fail to recognize dangers.

However, no system available today can completely eliminate injuries and fatalities in every accident situation. In particular, the seat belt and air bag generally do not protect against objects

penetrating the vehicle from the outside. It is also not possible to completely rule out the risk of injury caused by the air bag deploying.

Mercedes-Benz recommends that you have the vehicle towed to a qualified specialist workshop after an accident. Take this into account, particularly if an Emergency Tensioning Device is triggered or an air bag deployed.

If the Emergency Tensioning Devices are triggered or an air bag is deployed, you will hear a bang, and a small amount of powder may also be released:

- The bang will not generally affect your hearing.
- In general, the powder released is not hazardous to health but may cause short-term breathing difficulties to persons suffering from asthma or other pulmonary conditions.

Provided it is safe to do so, leave the vehicle immediately or open the window in order to prevent breathing difficulties.

Air bags and pyrotechnic Emergency Tensioning Devices contain perchlorate material, which may require special handling or environmental protec-

tion measures. National guidelines regarding waste disposal must be observed. In California, see the <https://dtsc.ca.gov/>. Using the search function, you will find information on perchlorate, for example.

### Information on the limited protection provided by the restraint system

#### **Risk due to the incorrect behavior of vehicle occupants**

All vehicle occupants must make sure of the following in particular:

- They observe the information on the correct seat position (→ page 37).
- There are no heavy, sharp-edged or fragile objects in the pockets of their clothing. Store such objects in a suitable place.

#### **⚠ WARNING Risk of injury or death due to an incorrect seat position**

The seat belt does not offer the intended level of protection if you have not moved the seat backrest to an almost vertical position.

In particular, you could slip beneath the seat-belt and become injured.

- ▶ Adjust the seat properly before beginning your journey.
- ▶ Always ensure that the seat backrest is in an almost vertical position and that the shoulder belt is routed across the center of your shoulder.

#### **Risk due to objects in the vehicle interior**

All vehicle occupants must make sure of the following in particular:

- They observe the information on the correct seat position (→ page 37).
- There are no objects between the seat, door and door pillar (B-pillar).

- There are no hard objects, e.g. coat hangers, hanging on the grab handles or coat hooks.
- There are no heavy, sharp-edged or fragile objects in the pockets of their clothing. Store such objects in a suitable place.

#### **⚠ WARNING Risk of injury or death due to blocked seat belt buckle or seat belt anchorage**

Objects next to the front seat that block the seat belt buckle or the moving seat belt anchorage on the front seat impair the function of the Emergency Tensioning Devices.

- ▶ Before starting the journey, make sure that there are no objects around the seat belt buckle or between the front seat and door.

#### **⚠ WARNING Risk of injury from objects in the deployment area of an airbag**

Objects in the deployment area of an airbag can hinder or prevent the correct deployment of the airbag.

The airbag may then deploy in an uncontrolled manner and may even cause additional injuries to the vehicle occupants by deploying. This may be the case in particular if the airbag is integrated into the seat.

- ▶ Always stow and secure objects correctly.
- ▶ Before commencing your journey, make sure that no objects are stowed in the deployment area of an airbag.

The installation location of an air bag is identified by the AIRBAG (→ page 52) symbol.

#### Risk due to installing accessories

Do not attach accessories such as mobile navigation devices, mobile phones or cup holders within the deployment area of an air bag, e.g. on the cockpit, on the door, on the side window or on the side trim.

In addition, no connecting cables, tensioning straps or retaining straps may be routed or attached to the vehicle within the deployment area of an air bag. Always comply with the accessory manufacturer's installation instructions and,

in particular, the notes on suitable places for installation.

**⚠ WARNING** Risk of injury or death due to unsuitable protective covers

Unsuitable protective covers mean that air bags can no longer protect vehicle occupants as they are designed to do.

- ▶ Use only protective covers approved by Mercedes-Benz for the seat in question.

In addition, the function of the automatic passenger air bag deactivation may be restricted by an unsuitable protective cover. If the front passenger seat is occupied, ensure that the PASSENGER AIR BAG indicator lamps display the correct status of the front passenger air bag (→ page 41).

#### Risk due to pets in the vehicle interior

**⚠ WARNING** Risk of accident and injury due to animals left unsecured or unattended in the vehicle

If you leave animals in the vehicle unattended or unsecured, they could possibly press buttons or switches.

An animal may:

- Activate vehicle equipment and become trapped, for example
- Switch systems on or off and endanger other road users

Unsecured animals may be thrown around in the vehicle in the event of an accident or sudden steering and braking maneuvers and injure vehicle occupants in the process.

- ▶ Never leave animals in the vehicle unattended.
- ▶ Always correctly secure animals while driving, e.g. using a suitable animal carrier.

**Risk due to modification, damage or wear to the components of the restraint system**

**NOTE** Mercedes-AMG vehicles

- ▶ Observe the notes in the Supplement. You could otherwise fail to recognize dangers.

**WARNING** Risk of injury or death due to modifications to the restraint system

Vehicle occupants may no longer be protected as intended if alterations are made to the restraint system.

- ▶ Never alter the parts of the restraint system.
- ▶ Never tamper with the wiring or any electronic component parts or their software.

If it is necessary to modify the vehicle to accommodate a person with disabilities, contact an authorized Mercedes-Benz Center for details.

USA only: for details, contact our Customer Assistance Center on 1-800-FOR-MERCEdes (1-800-367-6372).

**WARNING** Risk of injury or death due to damaged or modified seat belts

Seat belts cannot provide protection in the following situations:

- The seat belt is damaged, has been modified, is extremely dirty, bleached or dyed
- The seat belt buckle is damaged or extremely dirty
- Modifications have been made to the Emergency Tensioning Device, seat belt anchorage or seat belt retractor

Seat belts may sustain non-visible damage in an accident, e.g. due to glass splinters.

Modified or damaged seat belts could tear or fail in the event of an accident, for example.

Modified Emergency Tensioning Devices could accidentally trigger or fail to function as intended.

- ▶ Never modify the seat belt system, for example the seat belt, seat belt buckle, Emergency Tensioning Device, seat belt anchorage and seat belt retractor.
- ▶ Make sure that the seat belts are undamaged, not worn and clean.
- ▶ Always have the seat belts checked immediately after an accident at a qualified specialist workshop.

Use only seat belts that have been approved for your vehicle by Mercedes-Benz.

The seat is designed for the standard three-point seat belt. If you install a different multipoint seat belt, such as a four-point seat belt, the restraint system will not be able to provide the intended level of protection.

Depending on the type of vehicle, there may be openings in the seat backrest. These openings have no function.

**⚠ WARNING** Risk of injury or fatal injury due to modified seat belt systems

If you feed seat belts through the opening in the seat backrest, the seat backrest may be damaged or may even break in the event of an accident.

- ▶ Only use the standard three-point seat belt.
- ▶ Never modify the seat belt system.

**⚠ WARNING** Risk of injury due to modifications to the cover of an airbag

If you change the cover of an airbag or attach objects, e.g. even stickers, to it, the airbag may no longer function as intended.

- ▶ Never modify the cover of an airbag.
- ▶ Do not attach any objects to the cover.

The installation location of an air bag is identified by the AIRBAG symbol (→ page 52).

**⚠ WARNING** Risk of injury due to malfunctioning sensors in the door

The function of the airbags can be impaired due to modifications or incorrect work performed on the doors or door trim, or if the doors are damaged.

- ▶ Never modify the doors or parts of the doors.
- ▶ Always have work on the doors or door trim carried out at a qualified specialist workshop.

**Risk due to components of the restraint system that have already been deployed**

Mercedes-Benz recommends that you have the vehicle towed to a qualified specialist workshop after an accident.

**⚠ WARNING** Risk of burns from hot air bag components

The air bag parts are hot after an air bag has been deployed.

- ▶ Do not touch the air bag parts.

- ▶ Have a deployed air bag replaced at a qualified specialist workshop as soon as possible.

**⚠ WARNING** Risk of injury due to deployed airbag

A deployed airbag no longer offers any protection.

- ▶ Have the vehicle towed to a qualified specialist workshop in order to have the deployed airbag replaced.

Have deployed air bags replaced immediately.

**⚠ WARNING** Risk of injury or death from deployed pyrotechnic Emergency Tensioning Devices

Pyrotechnic Emergency Tensioning Devices that have been deployed are no longer operational and are unable to perform their intended protective function.

- ▶ Therefore, have deployed pyrotechnic Emergency Tensioning Devices immedi-

ately replaced at a qualified specialist workshop.

## Seat belts

### Releasing seat belts

- ▶ Press the release button in the seat belt buckle and guide the seat belt back with the seat belt tongue.

**!** **NOTE** Damage caused by trapping the seat belt

If an unused seat belt is not fully retracted, it may become trapped in the door or in the seat mechanism.

- ▶ Always ensure that an unused seat belt is fully retracted.

## Airbags

### Overview of air bags

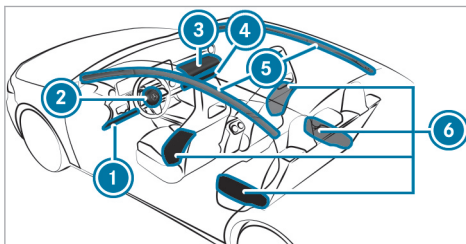

- ① Driver's knee air bag
- ② Driver's air bag
- ③ Front passenger air bag
- ④ Front passenger knee air bag
- ⑤ Window curtain air bag
- ⑥ Side impact air bag

The installation location of an air bag is identified by the AIRBAG symbol.

Observe the information under "Overview of deployment situations" (→ page 46).

### Brief overview of most important points

#### Safely transporting children in the vehicle

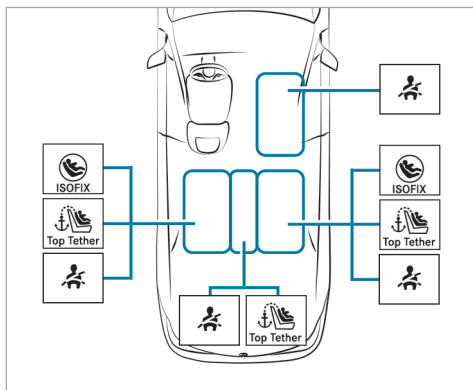

Always observe the following when transporting children:

- Do not leave children unsupervised in the vehicle (→ page 55).

- Secure children up to a height of 5 ft (1.50 m) on the respective seat (see illustration above) properly with a suitable and approved child restraint system, and secure small children in a rearward-facing child restraint system.
- Observe the child restraint system manufacturer's installation instructions.

#### Left/right rear seat (preferred seats)



Preferred securing system:

-  LATCH-type (ISOFIX) securing ring

and

-  Also secure Top Tether if present (→ page 63).

Alternative securing system:

-  Vehicle seat belt (→ page 65)
-  Additionally attach Top Tether if recommended by the manufacturer of the child restraint system (→ page 63).

#### Front passenger seat

Securing system:



-  Vehicle seat belt (→ page 65)

Be sure to observe:

- If the front passenger seat is occupied, ensure that the status of the front passenger air bag is correct for the current situation (→ page 41).

#### Center rear seat

Securing system:

-  Vehicle seat belt (→ page 65)
-  Additionally attach Top Tether if recommended by the manufacturer of the child restraint system (→ page 63).

### Important safety notes

#### Basic information

#### Be diligent

Bear in mind that negligence when securing a child in the child restraint system may have seri-

ous consequences. Always be diligent in securing a child carefully before every journey.

Never allow babies and children to travel sitting on the lap of another vehicle occupant.

To improve protection for children younger than 12 years old or under 5 ft (1.50 m) in height, Mercedes-Benz recommends you observe the following information:

- Always secure the child in a child restraint system suitable for this Mercedes-Benz vehicle.
- The child restraint system must be appropriate to the age, weight and size of the child.
- The vehicle seat must be suitable for the child restraint system to be installed:

Accident statistics show that children secured on the rear seats are generally safer than children secured on the front seats. For this reason, Mercedes-Benz strongly advises that you install a child restraint system on a rear seat.

### **The generic term "child restraint system"**

The generic term "child restraint system" is used in this Operator's Manual. A child restraint system is, for example:

- a baby car seat
- a rearward-facing child seat
- a forward-facing child seat
- a child booster seat – Mercedes-Benz recommends using a child booster seat **with** a backrest and seat belt guide.

### **Observe laws and legal requirements**

Always observe the legal requirements when using a child restraint system in the vehicle.

### **Securing systems for child restraint systems in the vehicle**

Use only the following securing systems for child restraint systems:

- the LATCH-type (ISOFIX) securing rings
- the vehicle's seat belt system
- the Top Tether anchorages

Simply attaching to the LATCH-type (ISOFIX) securing rings on the vehicle can reduce the risk of installing the child restraint system incorrectly.

When securing a child with the integrated seat belt of the ISOFIX/LATCH child restraint system, always comply with the permissible gross weight for the child and child restraint system (→ page 62).

A child booster seat may be necessary to achieve proper seat belt positioning for children over 40 lbs (18 kg) in weight or until they reach a height at which they can wear a three-point seat belt properly without a child booster seat.

Mercedes-Benz recommends a suitable child booster seat with a backrest and seat belt guide.

### **Observe standards for child restraint systems**

All child restraint systems must meet the following standards:

- U.S. Federal Motor Vehicle Safety Standards 213
- Canadian Motor Vehicle Safety Standards 213



Confirmation that the child restraint system complies with the standards can be found on an instruction label on the child restraint system. This confirmation can also be found in the installation instructions that are included with the child restraint system.

### Important warning notices

#### Always secure a child restraint system correctly

**⚠ WARNING** Risk of injury or death due to incorrect installation of the child restraint system

The child can then not be protected or restrained as intended.

- ▶ Be sure to comply with the manufacturer's installation instructions for the child restraint system and its correct use.
- ▶ Make sure that the entire base of the child restraint system always rests on the sitting surface of the seat.

- ▶ Never place objects (e.g. cushions) under or behind the child restraint system.
- ▶ Use child restraint systems only with the original cover designed for them.
- ▶ Always replace damaged covers with genuine covers.

- Always observe the vehicle-specific information.
  - Installing the ISOFIX child restraint system on the right and left rear seats (→ page 62).
  - Securing the child restraint system with the seat belt (→ page 65).
- Observe the warning labels in the vehicle interior and on the child restraint system.

**⚠ WARNING** Risk of injury or death due to unsecured child restraint systems in the vehicle

If the child restraint system is incorrectly mounted or unsecured, it may come loose.

The child can then not be protected or restrained as intended.

Unused child restraint systems could be flung around and hit vehicle occupants.

- ▶ Always comply with the manufacturer's installation instructions for the child restraint system and its correct use.
- ▶ Always fit child restraint systems correctly, even if they are transported in the vehicle unused.

#### Do not modify the child restraint system

**⚠ WARNING** Risk of injury due to modifications to the child restraint system

The child restraint system can no longer function properly. This poses an increased risk of injury.

- ▶ Never modify a child restraint system.
- ▶ Only affix accessories which have been specially approved for this child restraint system by the child restraint system's manufacturer.

### Use only child restraint systems that are in proper working condition

**⚠ WARNING** Risk of injury or death caused by the use of damaged child restraint systems

Child restraint systems or their retaining systems that have been subjected to stress in an accident may not be able to perform their intended protective function.

It may be the case that the child cannot be properly restrained.

- ▶ Always immediately replace child restraint systems that have been damaged or involved in an accident.
- ▶ Have the securing systems for the child restraint systems checked at a qualified specialist workshop before installing a child restraint system again.

### Avoid direct sunlight

**⚠ WARNING** Risk of burns when the child seat is exposed to direct sunlight

If the child restraint system is exposed to direct sunlight or heat, parts could heat up excessively.

Children could suffer burns from these parts, particularly the metallic parts of the child restraint system.

- ▶ Always make sure that the child restraint system is not exposed to direct sunlight.
- ▶ Cover the child restraint system with a blanket, for example.
- ▶ If the child restraint system has been exposed to direct sunlight, allow it to cool before securing a child into it.
- ▶ Never leave children unattended in the vehicle.

### Observe when stopping or parking

**⚠ WARNING** Risk of fatal injury due to exposure to extreme heat or cold in the vehicle

If persons, particularly children, are subjected to prolonged exposure to intense heat or cold, there is a risk of severe injury or even death.

- ▶ Never leave persons, particularly children, unattended in the vehicle.

**⚠ WARNING** Risk of accident and injury if children are left unattended in the vehicle

If children are left unattended in the vehicle, they could in particular:

- open doors, thereby endangering other persons or road users.
- get out and be struck by oncoming traffic.
- operate vehicle equipment and become trapped, for example.

In addition, the children could also set the vehicle in motion, for example by:

- releasing the parking brake.
  - changing gear.
  - starting the vehicle.
- ▶ Never leave children unattended in the vehicle.
  - ▶ When leaving the vehicle, always take the SmartKey with you and lock the vehicle.
  - ▶ Keep the SmartKey out of the reach of children.

### Notes on rearward-facing and forward-facing child restraint systems on the front passenger seat

**▲ WARNING** Risk of injury or fatal injury when using a rearward-facing child restraint system while the co-driver airbag is enabled

If you secure a child in a rearward-facing child restraint system on the co-driver seat and the

PASSENGER AIR BAG OFF indicator lamp is off, the co-driver airbag can deploy in the event of an accident.

The child could be struck by the airbag.

- ▶ Always ensure that the co-driver airbag is disabled. The PASSENGER AIR BAG OFF indicator lamp must be lit.
- ▶ NEVER use a rearward-facing child restraint system on a seat with an ENABLED FRONT AIRBAG; DEATH or SERIOUS INJURY to the CHILD can occur.

Observe the specific instructions for the rearward-facing and forward-facing child restraint systems (→ page 59).

If it is absolutely necessary to install a child restraint system on the front passenger seat, always observe the following notes:

- When using a rearward-facing child restraint system on the front passenger seat, the front passenger air bag must always be disabled. This is only the case if the PASSENGER AIR BAG OFF indicator lamp is lit continuously (→ page 41).

- The front passenger air bag is enabled when the PASSENGER AIR BAG OFF indicator lamp is not lit. The front passenger air bag may be deployed during an accident. In that case, do not use rearward-facing child restraint systems.

### Information on automatic front passenger air bag shutoff

If the front passenger seat is occupied, ensure, both before and during the journey, that the status of the front passenger air bag is correct for the current situation.

**▲ WARNING** Risk of injury or death due to objects between the seat surface and the child restraint system

Objects between the seat surface and the child restraint system can interfere with the function of the automatic front passenger air bag shutoff.

- ▶ Do not place any objects between the seat surface and the child restraint system.
- ▶ Make sure that the entire base of the child restraint system rests on the seat cushion of the front passenger seat.
- ▶ The backrest of a forward-facing child restraint system must, as far as possible, be resting against the seat backrest of the front passenger seat.
- ▶ Always comply with the installation instructions from the child restraint system manufacturer.

When installing a child restraint system on the front passenger seat, observe the vehicle-specific information (→ page 57).

#### **Rearward-facing child restraint system on the front passenger seat**

If a rearward-facing child restraint system is installed on the front passenger seat, the front passenger air bag must be disabled. The PASSENGER AIR BAG OFF indicator lamp must be continuously lit (→ page 41).

**⚠ WARNING** Risk of injury or fatal injury when using a rearward-facing child restraint system while the co-driver airbag is enabled

If you secure a child in a rearward-facing child restraint system on the co-driver seat and the PASSENGER AIR BAG OFF indicator lamp is off, the co-driver airbag can deploy in the event of an accident.

The child could be struck by the airbag.

- ▶ Always ensure that the co-driver airbag is disabled. The PASSENGER AIR BAG OFF indicator lamp must be lit.
- ▶ NEVER use a rearward-facing child restraint system on a seat with an ENABLED FRONT AIRBAG; DEATH or SERIOUS INJURY to the CHILD can occur.

- i** Depending on the child restraint system and the stature of the child, the front passenger air bag will be enabled. The PASSENGER AIR BAG OFF indicator lamp will not light up. The front passenger air bag may be deployed during an accident. If the front passenger air

bag has this status, no rearward-facing child restraint system may be installed on the front passenger seat. Instead, install the rearward-facing child restraint system on a suitable rear seat.

#### **Forward-facing child restraint system on the front passenger seat**

If a forward-facing child restraint system is installed on the front passenger seat, the front passenger air bag may be automatically enabled or disabled. The status of the front passenger air bag depends on the child restraint system and the stature of the child.

The PASSENGER AIR BAG OFF indicator lamp will either light up continuously or not light up (→ page 41). Always observe the following information.

**⚠ WARNING** Risk of injury or death caused by incorrect positioning of the child restraint system

If you secure a child in a forward-facing child restraint system on the front passenger seat and you position the front passenger seat too close to the cockpit, in the event of an accident, the child could:

- Come into contact with the vehicle interior if the PASSENGER AIR BAG OFF indicator lamp is lit, for example.
- Be struck by the air bag if the PASSENGER AIR BAG OFF indicator lamp is off.

▶ Always move the front-passenger seat as far back as possible. Always make sure that the shoulder belt strap is correctly routed from the seat belt outlet of the vehicle to the shoulder belt guide on the child restraint system. The shoulder belt strap must be routed forwards and downwards from the seat belt outlet. If

necessary, adjust the front-passenger seat accordingly.

- ▶ Always comply with the child restraint system manufacturer's installation instructions.

Be sure to also observe the following further related subjects:

- Function of the automatic front passenger air bag shutoff (→ page 41)

### Suitable child restraint systems for the transport of children

#### Information on the benefit of a rearward-facing child restraint system

Transport a baby in a suitable rearward-facing child restraint system only. It is also preferable to transport a small child in a suitable rearward-facing child restraint system. In this case, the child sits in the opposite direction to the direction of travel and faces backwards.

Babies and small children have comparatively weak neck muscles in relation to the size and weight of their head. The risk of injury to the cervical spine during an accident can be reduced in a rearward-facing child restraint system.

### Securing the child restraint system

#### Adjusting the seat correctly

**When installing a child restraint system on the left or right rear seat, always observe the following:**

- ▶ Make sure that the child's feet do not touch the front seat. If necessary, move the front seat slightly forwards.

If the head restraint of the child restraint system cannot be fully extended when it is installed in the vehicle, this will result in restrictions on the maximum size setting for certain child restraint systems. Observe the child restraint system manufacturer's installation instructions.

- ⓘ Contact with the roof when the head restraint is fully extended and locked in place will not result in any restrictions on use.

 **When installing an ISOFIX/LATCH child restraint system, also observe the following:**

- ▶ **When using a rearward-facing child restraint system on a rear seat:** adjust the front seat so that it does not touch the child restraint system.
- ▶ **When using a forward-facing child restraint system with integrated child seat belt:** adjust the head restraint of the respective seat so that it does not push the child restraint system forwards. If necessary, the respective head restraint can be removed. In addition, the backrest of the child restraint system must lie as flat as possible against the backrest of the vehicle seat. After the child restraint system has been removed, replace the vehicle head restraint immediately and adjust correctly.
- ▶ The child restraint system must not be put under strain between the roof and seat cushion and/or be installed facing the wrong direction. Where possible, adjust the seat cushion inclination accordingly.

- ▶ Adjust the vehicle head restraints so that the child restraint system is not put under strain by the head restraint.

 **When installing a belt-secured child restraint system, also observe the following:**

- ▶ **When using a rearward-facing child restraint system on a rear seat:** adjust the front seat so that it does not touch the child restraint system.
- ▶ Also secure Top Tether if present (→ page 63).
- ▶ **When using a forward-facing child restraint system with integrated child seat belt:** adjust the head restraint of the respective seat so that it does not push the child restraint system forwards. If necessary, the respective head restraint can be removed. In addition, the backrest of the child restraint system must lie as flat as possible against the backrest of the vehicle seat. After the child restraint system has been removed, replace the vehicle head restraint immediately and adjust correctly.

- ▶ The backrest of the forward-facing child restraint system must be resting as flat as possible on the seat backrest of the rear seat.
- ▶ The child restraint system must not be put under strain between the roof and seat cushion and/or be installed facing the wrong direction. Where possible, adjust the seat cushion inclination accordingly.
- ▶ Adjust the vehicle head restraints so that the child restraint system is not put under strain by the head restraint.
- ▶ Make sure that the child's feet do not touch the front seat. If necessary, move the front seat slightly forwards.

 **Depending on the vehicle equipment, always observe the following when installing a belt-secured child restraint system on the front passenger seat:**

- ▶ Observe the notes on rearward- and forward-facing child restraint systems on the front passenger seat (→ page 57).
- ▶ **When using a forward-facing child restraint system integrated child seat belt:** remove the

head restraint from the respective seat, if possible. After the child restraint system has been removed, immediately replace the head restraint and adjust correctly.

- ▶ The backrest of the forward-facing child restraint system must be resting as flat as possible on the seat backrest of the front passenger seat.
- ▶ The child restraint system must not be put under strain between the roof and seat cushion and/or be installed facing the wrong direction.
- ▶ Adjust the vehicle head restraints so that the child restraint system is not put under strain by the head restraint.
- ▶ Never place objects (e.g. cushions) under or behind the child restraint system.
- ▶ Set the front passenger seat as far back as possible and move the seat into the highest position if possible. Always make sure that the shoulder belt strap is correctly routed from the seat belt outlet of the vehicle to the shoulder belt guide on the child restraint system. The shoulder belt strap must be routed for-

wards from the seat belt outlet and, where possible, downwards to the child restraint system.

- ▶ Fully retract the seat cushion length adjustment.
- ▶ Adjust the seat cushion inclination so that the front edge of the seat cushion is in the highest position and the rear edge of the seat cushion is in the lowest position.
- ▶ Set the seat backrest to the most vertical position possible.

#### Activating or deactivating the special seat belt retractor of the seat belt

**⚠ WARNING** Risk of injury or death if a seat belt is unfastened while the vehicle is in motion

If the seat belt is released while the vehicle is in motion, the special seat belt retractor is deactivated and the child restraint system is no longer correctly secured. The seat belt is

drawn in slightly by the inertia reel and cannot be immediately closed again.

- ▶ Stop the vehicle immediately in accordance with the traffic conditions.
- ▶ Activate the special seat belt retractor again and correctly secure the child restraint system.

When enabled, the child seat safety feature ensures that the seat belts of the front passenger seat and rear seats do not slacken once the child restraint system is secured.

The seat belts on the following seats are equipped with a child seat safety feature:

- Front passenger seat
- Rear seats

#### Installing a child restraint system

- ▶ When installing a child restraint system, always observe the manufacturer's installation and operating instructions as well as the information in this Operator's Manual.

- ▶ Pull the seat belt smoothly from the seat belt outlet.
- ▶ Engage the seat belt tongue in the belt buckle.

#### Activating the special seat belt retractor:

- ▶ Pull the seat belt out fully and let the inertia reel retract it again. When the special seat belt retractor is activated, you should hear a ratcheting sound.
- ▶ Push the child restraint system down until the seat belt sits tightly.

#### Deactivating the special seat belt retractor:

- ▶ Press the release button of the seat belt buckle.
- ▶ Hold the seat belt tongue and guide back to the seat belt outlet.

#### Installing an ISOFIX/LATCH child restraint system

**⚠ WARNING** Risk of accident if the rear bench seat, rear seat and seat backrest are not engaged

The rear bench seat, rear seat and seat backrest may fold forwards, even when you are driving.

- As a result, the vehicle occupant will be pushed into the seat belt with increased force. The seat belt will not be able to protect as intended and could cause additional injury.
- Objects or loads in the trunk or cargo compartment will not be restrained by the seat backrest.

▶ Make sure that the rear bench seat, the rear seat and the seat backrest are engaged before every trip.

If the rear seat backrest is not engaged and locked in place, the red lock verification indicator will be visible.

**⚠ WARNING** Risk of injury or death if the permissible gross mass of the child and child restraint system together is exceeded.

Too much load may be placed on the LATCH-type (ISOFIX) or iSize child restraint systems and the child may not be restrained correctly in the event of an accident, for example.

- ▶ If the child is secured in a LATCH-type (ISOFIX) child restraint system with integrated seat belt, the total mass of the child and child restraint system must not exceed 73 lb (33 kg).

Always comply with the information about the mass of the child:

- in the manufacturer's installation and operating instructions for the child restraint system used
- on a label on the child restraint system, if available



Regularly check that the permissible gross mass of the child and child restraint system is still complied with.

When you install a child restraint system, observe the following:

- ☑ Always observe the correct use and suitability of the seats for attaching a child restraint system.  
LATCH-type (ISOFIX) securing rings

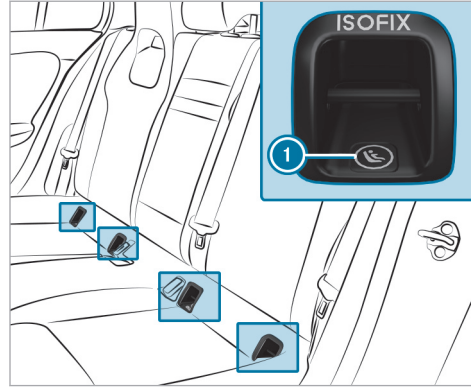

#### ① LATCH-type (ISOFIX) securing rings

- ▶ Before every journey, make sure that the ISO-FIX/LATCH child restraint system has correctly engaged both securing rings in the vehicle.

**!** **NOTE** Damage to the seat belt for the center seat during installation of the child restraint system

- ▶ Make sure that the seat belt is not trapped.

- ▶ Attach the ISOFIX/LATCH child restraint system to both securing rings in the vehicle.

#### Fastening a Top Tether

**!** **WARNING** Risk of injury or death if the rear seat backrests are not locked after Top Tether belts are installed

The rear seat backrests may fold forwards when you are driving.

As a result, child restraint systems will no longer be able to perform their intended protective function. This may also cause additional injuries.

- ▶ Always lock rear seat backrests after installing Top Tether belts.

- ▶ Observe the lock verification indicator.

If the rear seat backrest is not engaged and locked in place, the red lock verification indicator will be visible.

-  If the child restraint system is equipped with a Top Tether belt:

The risk of injury may be reduced by Top Tether. The Top Tether belt enables an additional connection between the child restraint system attached with ISOFIX (left and right rear seats) or the seat belt (all rear seats) and the vehicle.

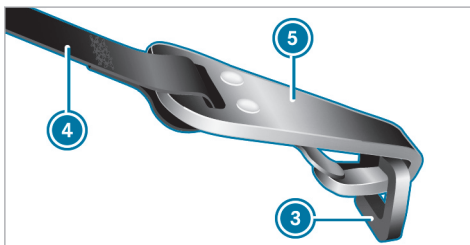
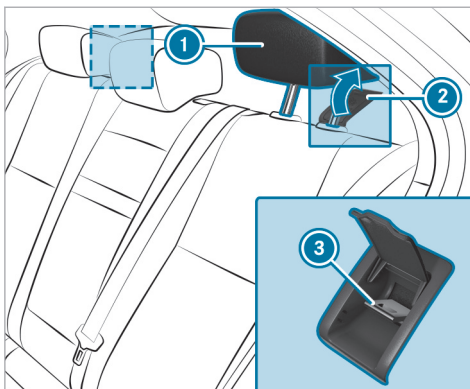

- ▶ Fold up cover 2 of Top Tether anchorage 3.

**Vehicles with adjustable head restraints:**

- ▶ If necessary, slide head restraint 1 upwards (→ page 100).
- ▶ Guide Top Tether belt 4 under head restraint 1 between the two head restraint bars.

**Vehicles without adjustable head restraints:**

- ▶ Top Tether belt with one seat belt strap: guide Top Tether belt 4 past head restraint 1 on the side nearest the door.
- or
- ▶ Top Tether belt with two seat belt straps: guide one Top Tether belt 4 past head restraint 1 on the right and left sides respectively.

**All vehicles:**

- ▶ Install the ISOFIX or belt-secured child restraint system with Top Tether. In doing so, comply with the child restraint system manufacturer's installation instructions.

- ▶ Hook Top Tether hook ⑤ of Top Tether belt ④ into Top Tether anchorage ③ without twisting.
- ▶ Tension Top Tether belt ④. In doing so, comply with the child restraint system manufacturer's installation instructions.
- ▶ Fold down cover ② of Top Tether anchorage ③.

#### Vehicles with adjustable head restraints:

- ▶ If necessary, slide head restraint ① downwards (→ page 100). Make sure that you do not interfere with the correct routing of Top Tether belt ④.

#### Securing the child restraint system with the seat belt

**⚠ WARNING** Risk of accident if the rear bench seat, rear seat and seat backrest are not engaged

The rear bench seat, rear seat and seat backrest may fold forwards, even when you are driving.

- As a result, the vehicle occupant will be pushed into the seat belt with increased force. The seat belt will not be able to protect as intended and could cause additional injury.
  - Objects or loads in the trunk or cargo compartment will not be restrained by the seat backrest.
- ▶ Make sure that the rear bench seat, the rear seat and the seat backrest are engaged before every trip.

If the rear seat backrest is not engaged and locked in place, the red lock verification indicator will be visible.

The seat belts on the following seats are equipped with a special seat belt retractor:

- Front passenger seat
- Rear seats

When enabled, the special seat belt retractor ensures that the seat belts of the front passenger seat and rear seats do not slacken once the child restraint system is secured.

- ▶ For a child restraint system in the "Universal" or "Semi-Universal" category, make sure that the system has been approved for the vehicle seat.
- ▶ Install the child restraint system. The entire base of the child restraint system must always rest on the sitting surface of the seat.
- ▶ Always make sure that the shoulder belt strap is correctly routed from the seat belt outlet of the vehicle to the shoulder belt guide on the child restraint system. The shoulder belt strap must be routed forwards from the seat belt outlet and, where

possible, downwards to the child restraint system.

- ▶ **When installing on the rear seat:** also secure Top Tether if present.
- ▶ **When installing on the front passenger seat:** if necessary, adjust the seat belt outlet and the front passenger seat accordingly.

### Child safety locks

#### Activating or deactivating the child safety lock for the rear doors

**⚠ WARNING** Risk of accident and injury if children are left unattended in the vehicle

If children are left unattended in the vehicle, they could in particular:

- open doors, thereby endangering other persons or road users.
- get out and be struck by oncoming traffic.
- operate vehicle equipment and become trapped, for example.

In addition, the children could also set the vehicle in motion, for example by:

- releasing the parking brake.
  - changing gear.
  - starting the vehicle.
- ▶ Never leave children unattended in the vehicle.
  - ▶ When leaving the vehicle, always take the SmartKey with you and lock the vehicle.
  - ▶ Keep the SmartKey out of the reach of children.

**⚠ WARNING** Risk of fatal injury due to exposure to extreme heat or cold in the vehicle

If persons, particularly children, are subjected to prolonged exposure to intense heat or cold, there is a risk of severe injury or even death.

- ▶ Never leave persons, particularly children, unattended in the vehicle.

**⚠ WARNING** Risk of accident and injury due to children left unattended in the vehicle

If children are traveling in the vehicle, they could, in particular:

- Open doors, thereby endangering other persons or road users.
  - Get out and be struck by oncoming traffic.
  - Operate vehicle equipment and become trapped, for example.
- ▶ Always activate the installed child safety locks if children are traveling in the vehicle.
  - ▶ Never leave children unattended in the vehicle.
  - ▶ When leaving the vehicle, always take the SmartKey with you and lock the vehicle.

There are child safety locks for the rear doors and the rear side windows.

The child safety lock on the rear doors secures each door separately. The doors can no longer be opened from the inside.

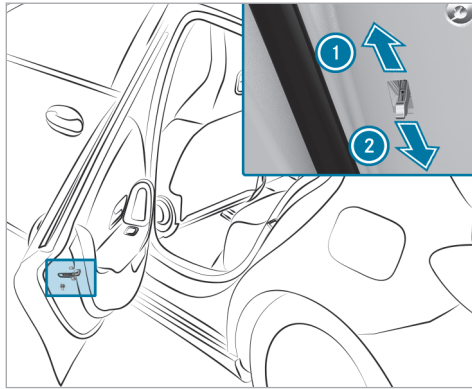

- ▶ Press the lever in direction ① (activate) or ② (deactivate).
- ▶ Make sure that the child-proof locks are working properly.

### Activating and deactivating the child safety lock for the rear side windows

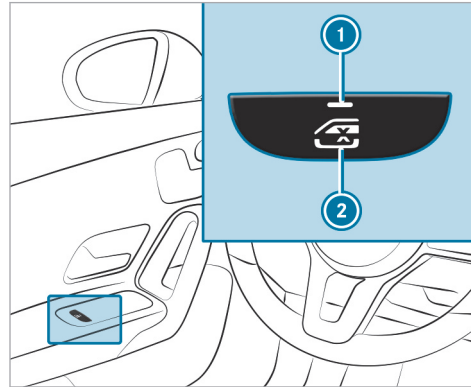

- ▶ **To activate/deactivate:** press button ②.

The rear side window can be opened or closed in the following cases:

- Indicator lamp ① is lit: via the switch on the driver's door

- Indicator lamp ① is off: via the switch on the corresponding rear door or driver's door

### Occupant presence reminder

#### Function of the occupant presence reminder

The occupant presence reminder can help to remind you about a child who may have been forgotten in the rear passenger compartment of the vehicle. It activates and deactivates automatically when a rear door is open for an extended period of time and a child, which the system presumes to be present, could enter or exit the vehicle.

When the vehicle is switched off, the **Do Not Leave People or Animals in the Vehicle** message will appear on the driver's display if the system has previously activated automatically.

You can permanently deactivate the function in the multimedia system (→ page 68). When the system is deactivated, the  indicator lamp on the driver's display lights up.

### Activating or deactivating the occupant presence reminder in the multimedia system

Multimedia system:

- ↳  ▶▶ Settings ▶▶ Vehicle
- ▶▶ Occupant Protection
- ▶ Activate or deactivate the function.

## SmartKey

### Overview of SmartKey functions

**⚠ WARNING** Risk of accident and injury due to children left unattended in the vehicle

If you leave children unattended in the vehicle, they could, in particular:

- open doors, thereby endangering other persons or road users.
- get out and be struck by oncoming traffic.
- operate vehicle equipment and become trapped, for example.

In addition, the children could also set the vehicle in motion by, for example:

- releasing the parking brake.
- changing the gearbox position.
- starting the vehicle.

▶ Never leave children unattended in the vehicle.

- ▶ When leaving the vehicle, always take the key with you and lock the vehicle.
- ▶ Keep the key out of reach of children.

**! NOTE** Damage to the SmartKey caused by magnetic fields



- ▶ Keep the SmartKey away from strong magnetic fields.



Vehicle key with panic alarm

- ① Locks
- ② Indicator lamp
- ③ Unlocks

- ④ Opens the trunk lid
- ⑤ Panic alarm

ⓘ If indicator lamp ② does not light up when the  or  button is pressed, the battery is weak or possibly discharged. Replace the battery as soon as possible.

Replace the SmartKey battery (→ page 71).

The SmartKey locks and unlocks the following components:

- Doors
- Fuel filler flap
- Trunk lid

If the vehicle is not opened within approximately 40 seconds after unlocking, it locks again. Anti-theft protection is armed again.

Do not keep the SmartKey together with electronic devices or metal objects. This can affect the SmartKey's functionality.

### Activating/deactivating the acoustic locking verification signal

Multimedia system:

→ [Home] >> Settings >> Vehicle

>> Open/Close

- ▶ Activate or deactivate the **Acoustic Lock**.

### Activating/deactivating the panic alarm

#### Requirements

- The vehicle is switched off.



- ▶ **To activate:** press button ① for approximately one second.

A visual and audible alarm is triggered.

- ▶ **To deactivate:** briefly press button ① again.

or

- ▶ Press the start/stop button.

A key belonging to the vehicle must be detected in the vehicle.

### Changing the unlocking settings

Possible unlocking functions of the SmartKey:

- Central unlocking
- Unlocking the driver's door and fuel filler flap

- ▶ **To switch between settings:** press the [Lock] and [Unlock] buttons simultaneously for approximately six seconds until the indicator lamp flashes twice.

Options when the unlocking function for the driver's door and fuel filler flap has been selected:

- **To unlock the vehicle centrally:** press the [Unlock] button twice.

- **Vehicles with KEYLESS-GO:** if you touch the inner surface of the door handle on the driver's door, only the driver's door and the fuel filler flap will be unlocked.



### Deactivating the function of the key

**Vehicles with KEYLESS-GO:** if you deactivate the function of the SmartKey, the KEYLESS-GO functions will also be deactivated. Access or drive authorization by KEYLESS-GO will then no longer be possible with that particular SmartKey. Activate the function of the SmartKey so that all its functions will again be available.

You can also deactivate the function of the SmartKey to reduce the energy consumption of the SmartKey if you do not use the vehicle or a SmartKey for an extended period of time.

- ▶ Press and hold the [Lock] button on the SmartKey.



- ▶ With the key button  pressed, immediately press key button  twice in quick succession.

The indicator light of the key lights up once briefly and once for a long time.

- ① The following options for re-activating the SmartKey are available:
  - Press any button on the SmartKey.
  - Start the vehicle with the SmartKey in the marked space in the center console (→ page 138).

### Removing/inserting the mechanical key

#### Removing the mechanical key

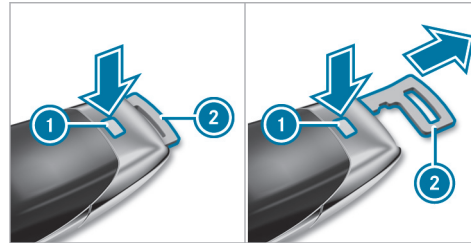

- ▶ Press release button ①.
- ▶ Emergency key ② is pushed out slightly.
- ▶ Pull out mechanical key ② until it engages in the intermediate position.
- ▶ Press release button ① again and fully remove mechanical key ②.

#### Inserting the mechanical key

- ▶ Press release button ①.
- ▶ Insert mechanical key ② to the intermediate position or fully until it engages.

- ① You can use the intermediate position of mechanical key ② to attach the key to a key ring.

### Replacing the key battery

**⚠ DANGER** Risk of fatal injury due to swallowing batteries

Batteries contain toxic and corrosive substances. If batteries are swallowed or otherwise enter the body, severe internal burns can occur within two hours.

There is a risk of fatal injury!

- ▶ Keep the batteries out of the reach of children.
- ▶ If the lid and/or the battery compartment do not close securely, stop using the key and keep it away from children.
- ▶ If batteries are swallowed or otherwise enter the body, seek immediate medical attention.

 **ENVIRONMENTAL NOTE** Environmental damage due to improper disposal of batteries



Batteries contain pollutants. It is illegal to dispose of them with the household rubbish.



Dispose of batteries in an environmentally responsible manner. Take discharged batteries to a qualified specialist workshop or to a collection point for used batteries.

### Requirements

- You require a CR 2032 3 V cell battery.

Mercedes-Benz recommends that you have the battery replaced at a qualified specialist workshop.

- Remove the mechanical key (→ page 71).

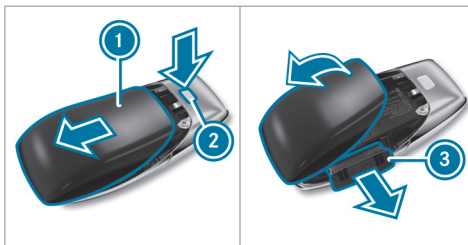

- Press release knob ② down fully and slide cover ① in the direction of the arrow.
- Fold out cover ① in the direction of the arrow and remove.
- Remove battery compartment ③ and take out the discharged battery.
- Insert the new battery into battery compartment ③. Observe the positive pole marking in the battery compartment and on the battery when doing this.
- Push in battery compartment ③.
- Re-attach cover ① and push it until it engages.

### Problems with the key, troubleshooting

#### You can no longer lock or unlock the vehicle

Possible causes are:

- The key battery is weak or discharged.
- Check the battery using the indicator lamp (→ page 69).
- Replace the key battery, if necessary (→ page 71).
- Use the replacement key.
- Use the mechanical key to lock or unlock (→ page 76).
- Have key checked at a qualified specialist workshop.

#### There is interference from a powerful radio signal source

Possible causes if the function of the key is impaired:

- high voltage power lines
- mobile phones
- electronic devices (notebooks, tablets)

- shielding due to metal objects or induction loops for electrical gate systems or automatic barriers

▶ Make sure that there is sufficient distance between the key and the potential source of interference.

#### You have lost a key

- ▶ Have the key deactivated at a qualified specialist workshop.
- ▶ If necessary, have the mechanical lock replaced as well.

### Doors

#### Unlocking/opening the doors from the inside

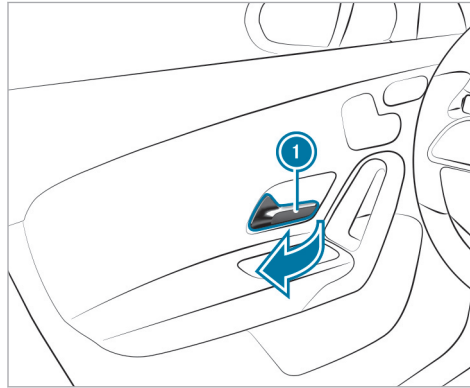

- ▶ **To unlock and open a front door:** pull door handle ①.
- ▶ **To unlock a rear door:** pull the rear door handle.
- ▶ **To open a rear door:** pull the rear door handle again.

#### Centrally locking and unlocking the vehicle from the inside

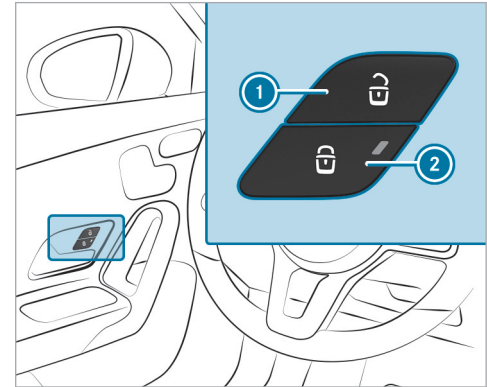

- ▶ **To unlock:** press ① button.
  - ▶ **To lock:** press button ②. The red indicator lamp on button ② lights up once the vehicle is locked.
- ⓘ The buttons are also on the front passenger door.

This does not lock or unlock the fuel filler flap.

The vehicle is not unlocked:

- if you have locked the vehicle using the key
- if you have locked the vehicle using KEYLESS-GO

### Locking/unlocking the vehicle with KEYLESS-GO

#### Requirements

- The key is outside the vehicle.
- The distance between the key and the vehicle does not exceed 3 ft (1 m).
- The driver's door and the door on which the door handle is used are closed.

**!** **NOTE** Damage to the vehicle caused by unintentionally opening the trunk lid

- When using an automatic car wash
  - When using a high pressure cleaner
- ▶ Deactivate the function of the SmartKey in these situations.

or

- ▶ Make sure that the SmartKey is at a minimum distance of 10 ft (3 m) away from the vehicle.

Observe the notes:

- on washing the vehicle in a car wash (→ page 282)
- on using a high-pressure cleaner (→ page 284)

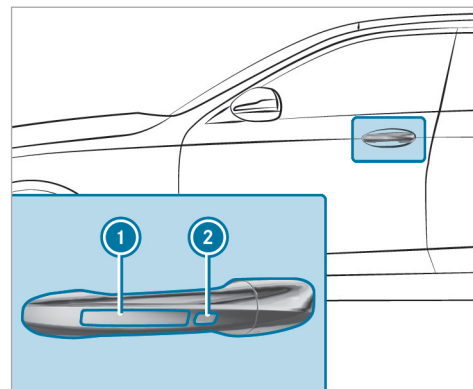

- ▶ **To unlock the vehicle:** touch the inner surface of the door handle.
- ▶ **To lock the vehicle:** touch sensor surface ① or ②.
- ▶ **Convenience closing:** touch recessed sensor surface ② until the closing process has been completed.

- ① Further information on convenience closing (→ page 84).

If you open the trunk lid from outside, the trunk lid is automatically unlocked.

### Problems with KEYLESS-GO, troubleshooting

#### You can no longer lock or unlock the vehicle using KEYLESS-GO

Possible causes:

- The function of the SmartKey has been deactivated.
  - The SmartKey battery is weak or discharged.
- ▶ Activate the function of the SmartKey (→ page 70).
  - ▶ Check the battery using the indicator lamp (→ page 69).
  - ▶ Replace the SmartKey battery, if necessary (→ page 71).
  - ▶ Use the replacement SmartKey.
  - ▶ Use the emergency key to lock or unlock (→ page 76).

- ▶ Have the vehicle and SmartKey checked at a qualified specialist workshop.

#### There is interference from a powerful radio signal source

Possible causes if the function of KEYLESS-GO is impaired:

- High voltage power lines
  - Mobile phones
  - Electronic devices (notebooks, tablets)
  - Shielding due to metal objects or induction loops for electrical gate systems or automatic barriers
- ▶ Make sure that there is sufficient distance between the SmartKey and the potential source of interference.

#### Activating/deactivating the automatic locking feature

The vehicle is locked automatically when the vehicle is switched on and the wheels are turning faster than walking pace.

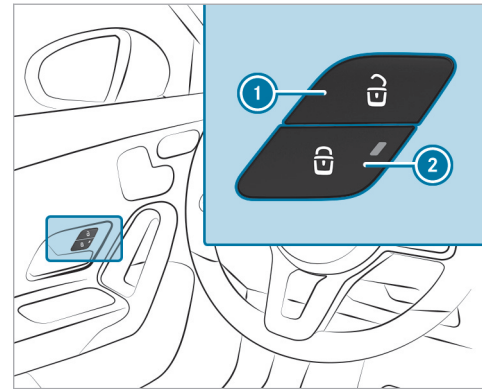

- ▶ **To activate:** press and hold button ② for approximately five seconds until an acoustic signal sounds.
- ▶ **To deactivate:** press and hold button ① for approximately five seconds until an acoustic signal sounds.

The red indicator lamp on button ② lights up once the vehicle is locked.

In the following situations, there is a danger of being locked out when the function is activated:

- while the vehicle is being tow-started or pushed
- if the vehicle is being tested on a roller dynamometer

### Activating/deactivating the automatic locking mechanism

Multimedia system:

→  ▶▶ Settings ▶▶ Vehicle  
▶▶ Open/Close

- ① The vehicle is locked automatically when it is switched on and the wheels are turning faster than walking pace.
- ▶ Activate or deactivate **Automatic Door Lock**.

In the following situations, there is a danger of being locked out when the function is activated:

- The vehicle is being towed or pushed.
- If the vehicle is being tested on a roller dynamometer.

### Locking/unlocking the vehicle with the mechanical key

#### Locking/unlocking the driver's door with the mechanical key

- ① If you wish to lock the vehicle entirely using the mechanical key, first press the button for locking from the inside while the driver's door is open. Then proceed to lock the driver's door using the mechanical key.
- ① If you unlock and open the driver's door with the mechanical key, this triggers the burglar alarm system.

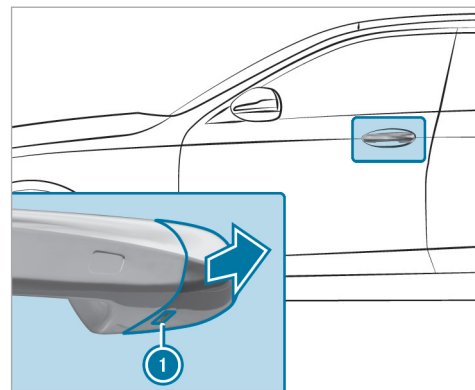

- ▶ Remove the mechanical key (→ page 71).
- ▶ Insert the mechanical key as far as it will go into opening ① in the cover.
- ▶ Pull and hold the door handle.
- ▶ Pull the cover on the mechanical key as straight as possible away from the vehicle until it releases.
- ▶ Release the door handle.

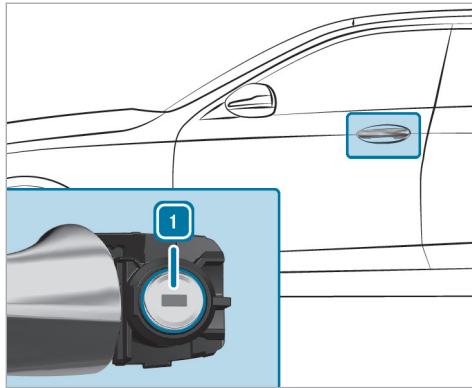

- ▶ **To unlock:** turn the mechanical key counter-clockwise to position 1.
- ▶ **To lock:** turn the mechanical key clockwise to position 1.
- ▶ Carefully press the cover onto the lock cylinder until it engages and is seated firmly.

#### Locking the front passenger door and rear doors

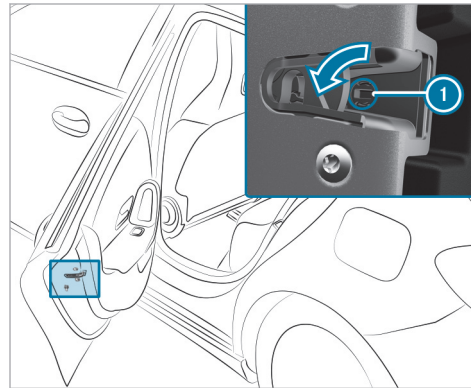

- ▶ Insert a suitable object, e.g. the mechanical key, into opening 1 on the door lock.
- ▶ **To lock the left-hand side of the vehicle:** turn the mechanical key counter-clockwise as far as it will go.

- ▶ **To lock the right-hand side of the vehicle:** turn the mechanical key clockwise as far as it will go.

If the locked door is then closed, it can no longer be opened from the outside.

#### Trunk

##### Opening the trunk lid

#### ⚠ DANGER Risk of exhaust gas poisoning

Combustion engines emit poisonous exhaust gases such as carbon monoxide. Exhaust gases can enter the vehicle interior if the trunk lid is open when the engine is running, especially if the vehicle is in motion.

- ▶ Always switch off the engine before opening the trunk lid.
- ▶ Never drive with the trunk lid open.

**NOTE** Damage to the trunk lid by obstacles above the vehicle

The trunk lid swings upwards when it is opened.

► Therefore, make sure that there is sufficient clearance above the trunk lid.

► **Vehicles with HANDS-FREE ACCESS:** Make a kicking movement with your foot below the bumper (→ page 79).

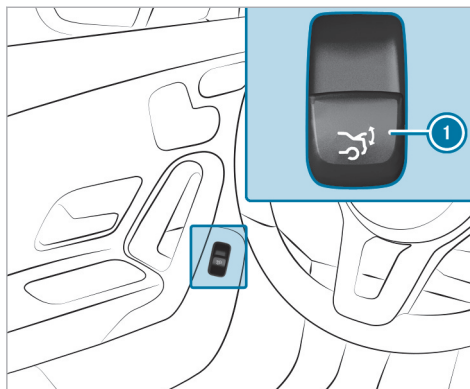

► Pull remote operating switch ① until the trunk lid opens.

or

► Press and hold the  button on the Smart-Key.

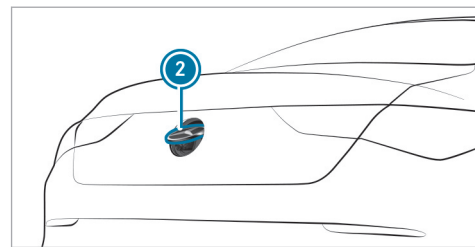

► With the trunk lid unlocked, press the top of the Mercedes star ②.

**i** To open, pull on the folded-out Mercedes star when the reversing camera is activated.

### Closing the trunk lid

**WARNING** Risk of injury from unsecured items in the vehicle

If objects, luggage or loads are not secured or not secured sufficiently, they could slip, tip over or be thrown around and thereby hit vehicle occupants.



There is a risk of injury, particularly in the event of sudden braking or a sudden change in direction.

- ▶ Always stow objects in such a way that they cannot be thrown around.
- ▶ Before the journey, secure objects, luggage or loads against slipping or tipping over.

Observe the notes on loading the vehicle.

**Notes on closing the trunk lid:** your vehicle is equipped with automatic SmartKey recognition. If a SmartKey belonging to the vehicle is detected in the vehicle, the trunk lid will not be locked and will pop open again.

Note that the trunk lid will not be locked if the following situation occurs:

- You have locked the vehicle and close the trunk lid while a SmartKey belonging to the vehicle is inside the vehicle.
- and
- A second SmartKey belonging to the vehicle is not detected outside the vehicle.

Automatic SmartKey recognition is only an aid and is not a substitute for your attentiveness.

- ▶ Before locking, ensure that at least one SmartKey belonging to the vehicle is outside the vehicle.
- ▶ **To close the trunk lid:** pull the trunk lid downwards using the handle recess and push it closed.

### HANDS-FREE ACCESS function

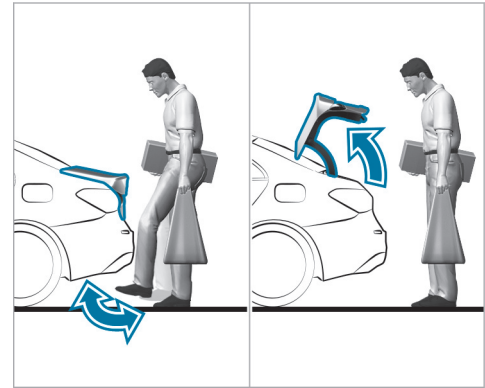

With HANDS-FREE ACCESS, you can open the trunk lid by performing a kicking movement under the bumper. The transmission must be in position **P** for this.

Observe the notes when opening the trunk lid (→ page 77).

**⚠ WARNING** Risk of burns caused by a hot exhaust system

The vehicle exhaust system can become very hot. If you use HANDS-FREE ACCESS, you could burn yourself by touching the exhaust system.

- ▶ Always ensure that you only make a kicking movement within the detection range of the sensors.

**⚠ NOTE** Damage to the vehicle caused by unintentionally opening the trunk lid

- When using an automatic car wash
  - When using a high pressure cleaner
  - ▶ Deactivate the function of the SmartKey in these situations.
- or
- ▶ Make sure that the SmartKey is at a minimum distance of 10 ft (3 m) away from the vehicle.

When making the kicking movement, make sure that your footing is firm. You could otherwise lose your balance, e.g. on ice.

Observe the following notes:

- The SmartKey is behind the vehicle.  
If the SmartKey is not recognized:
  - Hold the SmartKey in your hand.
  - or
  - Ensure that the SmartKey function is activated (→ page 70).
- Stand at least 12 in (30 cm) away from the vehicle while performing the kicking movement.
- Do not touch the bumper while making the kicking movement.
- Do not carry out the kicking movement too slowly.
- The kicking movement must be towards the vehicle and back again.

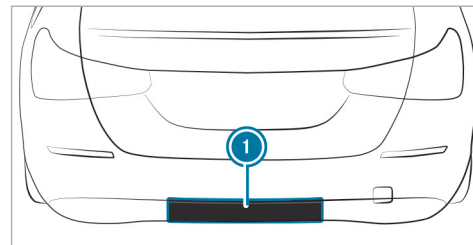

**①** Detection range of the sensors

If several consecutive kicking movements are not successful, wait ten seconds.

**System limits**

The system may be impaired or may not function in the following cases:

- The sensors are dirty, e.g. due to road salt or snow.
- The kicking movement is made using a prosthetic leg.

The trunk lid could be opened unintentionally in the following situations:

- A person's arms or legs are moving in the sensor detection range, e.g. when polishing the vehicle or picking up objects.
- Objects are moved or placed behind the vehicle, e.g. the hose of a fuel dispenser, a charging cable or luggage
- Clamping straps, tarp or other coverings are pulled over the bumper.
- A protective mat with a length reaching over the loading sill down into the detection range of the sensors is used.
- The protective mat is not secured correctly.

Deactivate the function of the SmartKey (→ page 70) or do not carry the SmartKey about your person in such situations.

### Unlocking and opening the trunk from inside with the emergency release

#### Requirements

- The 12 V vehicle battery is connected and charged.

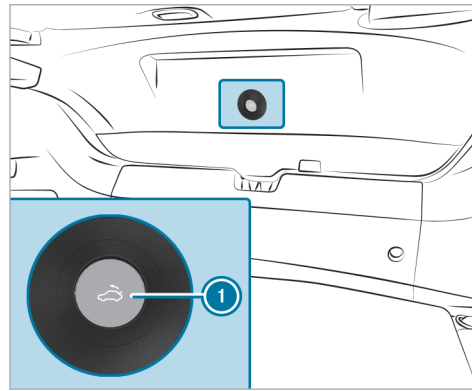

- ▶ Press emergency release button ① briefly.

### Activating/deactivating the trunk lid opening height restriction

Multimedia system:

→ ▶ Settings ▶ Vehicle  
▶ Other Functions

- ▶ Switch **Opening Height Limiter** on or off.

This function prevents the trunk lid from hitting a low garage ceiling, for example.

### Side windows

#### Opening and closing the side windows

**⚠ WARNING** Risk of entrapment when opening a side window

When opening a side window, parts of the body could be drawn in or become trapped between the side window and window frame.

- ▶ When opening, make sure that nobody is touching the side window.

- ▶ If someone is trapped, release the button immediately or pull it in order to close the side window again.

**⚠ WARNING** Risk of becoming trapped when closing a side window

When closing a side window, body parts could be trapped in the closing area in the process.

- ▶ When closing, make sure that no body parts are in the closing area.
- ▶ If someone is trapped, release the button immediately or press the button in order to reopen the side window.

**⚠ WARNING** Risk of becoming trapped when children operate the side windows

Children could become trapped if they operate the side windows, particularly when unattended.

- ▶ Activate the child safety lock for the rear passenger compartment side windows.

- ▶ When leaving the vehicle, always take the SmartKey with you and lock the vehicle.
- ▶ Never leave children unattended in the vehicle.

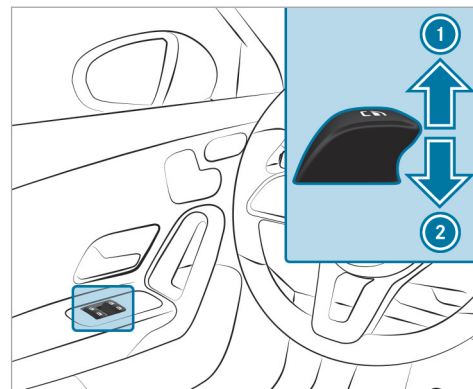

**Requirements:**

- The power supply or the vehicle has been switched on.



- ① Closing
- ② Opening

The buttons on the driver's door take precedence.

- ▶ **To start automatic operation:** press the  button beyond the pressure point or pull and release it.
- ▶ **To interrupt automatic operation:** press or pull the  button again.

When the vehicle is switched off, you can continue to operate the side windows.

This function is available for around four minutes or until a front door is opened.

#### Automatic reversing function of the side windows

If an obstacle impedes a side window during the closing process, the side window will open again automatically. The automatic reversing function is only an aid and is not a substitute for your attentiveness.

- ▶ During the closing process, make sure that no body parts are in the closing area.

**▲ WARNING** Risk of becoming trapped despite there being reversing protection on the side window

The reversing function does not react:

- To soft, light and thin objects, e.g. fingers.
- During resetting.

The reversing function cannot prevent someone from becoming trapped in these situations.

- ▶ During the closing process, make sure that no body parts are in the closing area.
- ▶ If someone becomes trapped, press the  button to open the side window again.

#### Convenience opening (ventilating the vehicle before starting a journey)

**▲ WARNING** Risk of entrapment when opening a side window

When opening a side window, parts of the body could be drawn in or become trapped between the side window and window frame.

- ▶ When opening, make sure that nobody is touching the side window.
- ▶ Release the button immediately if somebody becomes trapped.

#### Requirements



- The SmartKey is in the immediate vicinity of the vehicle.

- ▶ Press and hold the  button on the SmartKey.

The following functions will be performed:

- The vehicle will be unlocked.
- The side windows will be opened.
- The panoramic sliding sunroof will be opened.
- The driver's seat ventilation will be switched on

- ① If the roller sunblind of the panoramic sliding sunroof is closed, the roller sunblind will be opened first.

- ▶ **To interrupt convenience opening:** release the  button.
- ▶ **To continue convenience opening:** press and hold the  button again.

### Convenience closing (closing the vehicle from outside)

**⚠ WARNING** Risk of entrapment due to not paying attention during convenience closing

When the convenience closing feature is operating, parts of the body could become trapped in the closing area of the side window and the sliding sunroof.

- ▶ When the convenience closing feature is operating, monitor the entire closing process and make sure that no body parts are in the closing area.

#### Requirements

- The SmartKey is in the immediate vicinity of the vehicle.
  - ▶ Press and hold the  button on the SmartKey.
- The following functions will be performed:
- The vehicle will be locked.
  - The side windows will be closed.

- The panoramic sliding sunroof will be closed.

▶ **To interrupt convenience closing:** release the  button.

▶ **To continue convenience closing:** press and hold the  button again.

① Convenience closing also functions with KEY-LESS-GO (→ page 74).

### Resolving problems with the side windows

**⚠ WARNING** Risk of becoming trapped or fatally injured if reversing protection is not activated

If you close a side window again immediately after it has been blocked, the side window will close with increased or maximum force. The reversing function is then not active and body parts may become trapped.

- ▶ Make sure that no parts of the body are in the closing area.

- ▶ To stop the closing process, release the button or press the button again to reopen the side window.

**A side window cannot be closed and you cannot see the cause.**

- ▶ Check to see whether any objects are in the window guide.
- ▶ Adjust the side windows.

#### Adjusting the side windows

If a side window is obstructed during closing and reopens again immediately:

- ▶ Immediately after this, pull and hold the corresponding button again until the side window has closed and hold the button for at least one more second (re-adjustment). The side window will be closed without the automatic reversing function.

If the side window is obstructed again and reopens again immediately:

- ▶ Immediately after this, pull and hold the corresponding button again until the side window

has closed and hold the button for at least one more second (follow-up adjustment).  
The side window will be closed without the automatic reversing function.

### The side windows cannot be opened or closed using the convenience opening feature.

Possible causes are:

- The key battery is weak or discharged.
- ▶ Check the battery using the indicator lamp (→ page 69).
- ▶ Replace the key battery, if necessary (→ page 71).

## Sliding sunroof

### Opening and closing the sliding sunroof

- i** The term "sliding sunroof" also refers to the panorama roof with power tilt/sliding panel.

**⚠ WARNING** Risk of becoming trapped when the sliding sunroof is being opened and closed

Body parts may become trapped in the range of movement.

- ▶ During opening and closing, make sure that no body parts are in the range of movement.
- ▶ Release the button immediately if somebody becomes trapped.

or

- ▶ Briefly press the button in any direction during automatic operation.  
The opening or closing process will be stopped.

**⚠ WARNING** Risk of becoming trapped if the sliding sunroof is operated by children

Children operating the sliding sunroof could get caught in the moving parts, particularly if unattended.

- ▶ Never leave children unattended in the vehicle.
- ▶ When leaving the vehicle, always take the key with you and lock the vehicle.

**⚠ WARNING** Risk of becoming trapped when the roller sunblind is being opened and closed

Body parts may become trapped between the roller sunblind and frame or sliding roof.

- ▶ When opening or closing, make sure that no body parts are in the roller sunblind's range of movement.
- ▶ Release the button immediately if somebody becomes trapped.

or

- ▶ Briefly press the button in any direction during automatic operation.  
The opening or closing process will be stopped.

**!** NOTE Malfunction due to snow and ice

Snow and ice may cause the sliding sunroof to malfunction.

- ▶ Open the sliding sunroof only if it is free of snow and ice.

**!** NOTE Damage caused by protruding objects

Objects that protrude from the sliding sunroof may damage the seals.

- ▶ Do not allow anything to protrude from the sliding sunroof.

**!** NOTE Damage to the panorama roof with power tilt/sliding panel due to non-approved roof luggage racks

The panorama roof with power tilt/sliding panel may be damaged by the roof luggage rack if you attempt to open it when using a roof luggage rack not tested and approved for Mercedes-Benz.

- ▶ When a roof luggage rack is installed, open the panorama roof with power tilt/sliding panel only if this has been tested and approved for Mercedes-Benz.

The panorama roof with power tilt/sliding panel may be raised to allow ventilation of the vehicle interior.

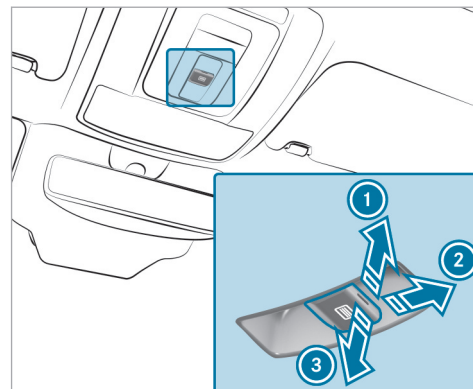



- 1 Raise
- 2 Open
- 3 Close/lower

Use the  button to operate the panorama roof with power tilt/sliding panel and the roller sunblind.



The panorama roof with power tilt/sliding panel can be operated only when the roller sunblind is open.

- ▶ Check whether the sliding sunroof can be raised or opened when a roof luggage rack is installed.
- ▶ **To start automatic operation:** press the  button beyond the point of resistance or pull and release it.
- ▶ **To interrupt automatic operation:** briefly press the  button in any direction. The opening/closing process will be stopped.

**Vehicles with a panorama roof with power tilt/sliding panel:** the automatic raising feature is available only when the sliding sunroof is closed or raised.

#### Automatic reversing function of the sliding sunroof

If an obstacle obstructs the sliding sunroof during the closing process, the sliding sunroof will open again automatically. The automatic reversing function is only an aid and is not a substitute for your attentiveness.

- ▶ During the closing process, make sure that no body parts are in the closing area.

#### **WARNING** Risk of becoming trapped despite the reversing function being active

In particular, the reversing function does not react:

- To soft, light and thin objects, e.g. fingers.
- Towards the end of the closing procedure.
- During resetting.

- ▶ During the closing process, make sure that no body parts are in the closing area.
- ▶ Release the button immediately if somebody becomes trapped.

or

- ▶ Briefly press the button in any direction during automatic operation. The closing process will be stopped.

#### Automatic reversing function of the roller sunblind

If an obstacle obstructs the roller sunblind during the closing process, the roller sunblind will open

again automatically. The automatic reversing function is only an aid and is not a substitute for your attentiveness.

- ▶ When closing the roller sunblind, make sure that no body parts are in the area of movement.

#### **WARNING** Risk of becoming trapped despite reversing function

In particular, the reversing function does not react to soft, light and thin objects, e.g. fingers.

- ▶ When closing the roller sunblind, make sure that no body parts are in the range of movement.
- ▶ Release the button immediately if somebody becomes trapped.

or

- ▶ Briefly press the button in any direction during the automatic closing process. The closing process will be stopped.

### Automatic functions of the sliding sunroof

- ① The term "sliding sunroof" also refers to the panoramic sliding sunroof.

#### Rain closing function when driving

**Vehicles with a panoramic sliding sunroof:** if it starts to rain, the raised sliding sunroof will automatically be lowered while the vehicle is in motion.

#### Automatic lowering function

**Vehicles with a panoramic sliding sunroof:** if the sliding sunroof is raised at the rear, it will automatically be lowered slightly at higher speeds. At low speeds, it will be raised again automatically.

**⚠ WARNING** Risk of becoming trapped by automatic lowering of the sliding sunroof

At higher speeds, the raised sliding sunroof will automatically be lowered slightly at the rear.

- ▶ Make sure that nobody reaches into the sliding sunroof's range of movement while the vehicle is in motion.

- ▶ If somebody becomes trapped, briefly push the sliding sunroof button forwards or backwards.

- ① By pushing or pulling the  button, you can interrupt the automatic functions "Rain closing function when driving" and "Automatic lowering".

### Rectifying problems with the sliding sunroof

**⚠ WARNING** Risk of becoming trapped or fatal injuries when the sliding sunroof is closed again

If the sliding sunroof is closed again immediately after it has been blocked or reset, it will close with increased force.

- ▶ Make sure that no parts of the body are in the closing area.
- ▶ Release the button immediately if somebody becomes trapped.

or

- ▶ Briefly press the button in any direction during the automatic closing process. The closing process will be stopped.

**The sliding sunroof cannot be closed and you cannot see the cause.**

- ① The term "sliding sunroof" also refers to the panorama roof with power tilt/sliding panel.

If the sliding sunroof is obstructed during closing and reopens again slightly:

- ▶ Immediately after automatic reversing, pull and hold the  button down again to the point of resistance until the sliding sunroof is closed. The sliding sunroof will be closed with increased force.



If the sliding sunroof is obstructed again and opens again slightly:

- ▶ Repeat the previous step. The sliding sunroof will be closed again with increased force.

**Vehicles with a panorama roof with power tilt/sliding panel: The sliding sunroof or the roller sunblind is not operating smoothly.**

- ▶ Reset the sliding sunroof and the roller sunblind.

**Resetting the sliding sunroof and the roller sunblind**

- ▶ Pull and hold the  button little by little until the sliding sunroof is fully closed.
- ▶ Pull and hold the  button little by little until the roller sunblind is fully closed.
- ▶ Use automatic operation to fully open and then close the sliding sunroof.

## Anti-theft protection

### Function of the immobilizer

The immobilizer prevents your vehicle from being started without the correct key.

The immobilizer is automatically activated when the vehicle is switched off, and deactivated when the vehicle is switched on.

When leaving the vehicle, always take the key with you and lock the vehicle. Anyone can start the vehicle if a valid key has been left inside the vehicle.

- ⓘ In the event the engine cannot be started (yet the vehicle's battery is charged), the system is not operational. Contact an authorized Mercedes-Benz Center or call 1-800-FOR-MERCEdes (in the USA) or 1-800-387-0100 (in Canada).

### ATA (anti-theft alarm system)

#### Function of the ATA system

If the ATA system is armed, a visual and audible alarm is triggered in the following situations:

- When a door is opened
- When the trunk lid is opened
- When the hood is opened
- When interior protection is triggered (→ page 90)
- When the tow-away alarm is triggered (→ page 90)

The ATA system is armed automatically after approximately ten seconds in the following situations:

- After you lock the vehicle with the key
- After you lock the vehicle using KEYLESS-GO

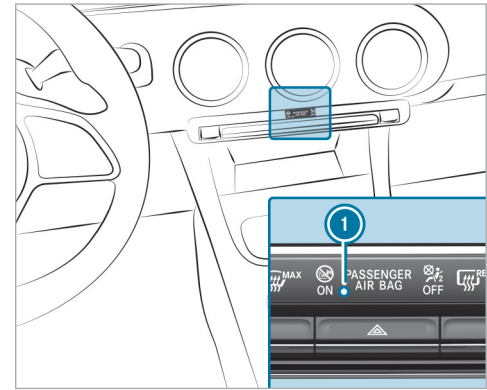

Indicator lamp ① flashes when the ATA system is armed.

The ATA system is deactivated automatically in the following situations:

- After you unlock the vehicle with the key
  - After you unlock the vehicle using KEYLESS-GO
  - After you press the start/stop button with the key in the marked space (→ page 138)
- ⓘ If the battery is heavily discharged, the anti-theft alarm system is automatically deactivated in favor of the next engine start.

#### Deactivating the ATA

▶ Press the ,  or  button on the key.

or

▶ Press the start/stop button with the key in the stowage compartment (→ page 138)

#### Deactivating the alarm using KEYLESS-GO

▶ Grasp the outside door handle with the key outside the vehicle.

#### Function of the tow-away alarm

ⓘ This function may not be available in all countries.

An audible and visual alarm is triggered if an alteration to your vehicle's angle of inclination is detected while the tow-away alarm is armed.



The tow-away alarm is automatically armed after about 60 seconds:

- after you lock the vehicle with the key
- after you lock the vehicle using KEYLESS-GO

The tow-away alarm is armed only when the following components are closed:

- Doors
- Trunk lid

The tow-away alarm is automatically deactivated:

- after you press the  or  button on the key
- after you press the start/stop button with the key in the marked space (→ page 138)
- after you unlock the vehicle using KEYLESS-GO

- when you are using HANDS-FREE ACCESS

Information on collision detection when the vehicle is parked (→ page 165).

#### Arming/deactivating tow-away alarm

Multimedia system:

-  ▶▶ Settings ▶▶ Vehicle  
 ▶▶ Opening/closing ▶▶ Vehicle Protection  
 ▶ Arm or deactivate **Tow-away Protection**.

Tow-away alarm is armed again in the following cases:

- The vehicle is unlocked again.
- A door is opened.
- The vehicle is locked again.

#### Function of interior protection

ⓘ This function may not be available in all countries.

When interior protection is armed, a visual and audible alarm is triggered if movement is detected in the vehicle interior.



Interior protection is armed automatically after approximately ten seconds:

- after locking the vehicle with the key
- after locking the vehicle using KEYLESS-GO

Interior protection is armed only when the following components are closed:

- Doors
- Trunk lid

Interior protection is automatically deactivated:

- after pressing the  or  button on the key
- after pressing the start/stop button with the key in the stowage compartment (→ page 138)
- after unlocking the vehicle using KEYLESS-GO
- when using HANDS-FREE ACCESS

The following situations can lead to a false alarm:

- when there are moving objects such as mascots in the vehicle interior
- if a side window is open
- if the panorama roof with power tilt/sliding panel is open

### Arming/deactivating interior protection

Multimedia system:

- ↳  » Settings » Vehicle
- » Opening/closing » Vehicle Protection
- ▶ Arm or deactivate [Interior Motion Sensor](#).

Interior protection is armed again in the following cases:

- The vehicle is unlocked again.
- A door is opened.
- The vehicle is locked again.

### Notes on the correct driver's seat position

**⚠ WARNING** Risk of accident due to adjusting the vehicle settings while the vehicle is in motion

You could lose control of the vehicle in the following situations in particular:

- If you adjust the driver's seat, the head restraint, the steering wheel or the mirror while the vehicle is in motion
- If you fasten your seat belt while the vehicle is in motion

▶ Before starting the vehicle: in particular, adjust the driver's seat, head restraint, steering wheel and mirror, and fasten your seat belt.

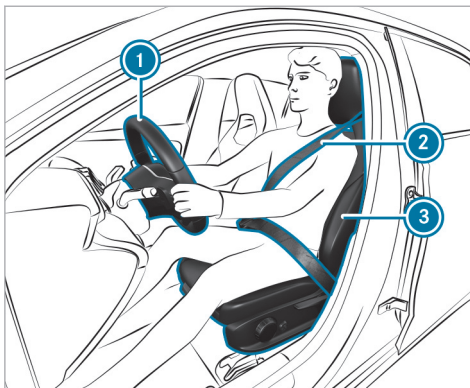

Ensure the following when adjusting steering wheel ①, seat belt ② and driver's seat ③:

- You are sitting as far away from the driver's air bag as possible, taking the following points into consideration:
- You are sitting in an upright position
- Your thighs are slightly supported by the seat cushion

- Your legs are not fully extended and you can depress the pedals properly
- The back of your head is supported at eye level by the center of the head restraint
- You can hold the steering wheel with your arms slightly bent
- You can move your legs freely
- You can see all the displays on the driver display clearly
- You have a good overview of the traffic conditions
- Observe the notes on correctly fastening the seat belt (→ page 38).

**Vehicles with an AMG Performance seat:** if the front passenger seat is unoccupied, this can lead to noise caused by the seat belt tongue knocking against the seat. You can prevent this by sliding the seat belt tongue upwards with the seat belt adjuster clip. If the front passenger seat is occupied, ensure that the seat belt adjuster clip is pushed down. Only then will the seat belt fit snugly against the body.

### Notes on grab handles

**⚠ WARNING** Risk of injury due to excessive load on the grab handles

If you apply your full body weight to the grab handle or pull it abruptly, the grab handle may be damaged or come loose from its anchorage. This may result in injuries.

- ▶ Use the grab handles only to stabilize the seating position or to assist in getting in and out of the seat.

### Seats

#### Adjusting the front seat manually (without Seat Comfort Package)

**⚠ WARNING** Risk of becoming trapped if the seats are adjusted by children

Children could become trapped if they adjust the seats, particularly when unattended.

- ▶ When leaving the vehicle, always take the SmartKey with you and lock the vehicle.
- ▶ Never leave children unattended in the vehicle.

**⚠ WARNING** Risk of becoming trapped when adjusting the seat

When you adjust a seat, you or other vehicle occupants could become trapped, e.g. on the seat guide rail.

- ▶ When adjusting a seat, make sure that no one has any part of their body within the sweep of the seat.

Observe the safety notes on "Air bags" and "Children in the vehicle".

**⚠ WARNING** Risk of accident due to the driver's seat not being engaged

The driver's seat may move unexpectedly while driving.

This could cause you to lose control of the vehicle.

- ▶ Always make sure that the driver's seat is engaged before starting the vehicle.

**⚠ WARNING** Risk of accident due to adjusting the vehicle settings while the vehicle is in motion

You could lose control of the vehicle in the following situations in particular:

- If you adjust the driver's seat, the head restraint, the steering wheel or the mirror while the vehicle is in motion
  - If you fasten your seat belt while the vehicle is in motion
- ▶ Before starting the vehicle: in particular, adjust the driver's seat, head restraint, steering wheel and mirror, and fasten your seat belt.

**⚠ WARNING** Risk of becoming trapped if the seat height is adjusted carelessly

If you adjust the seat height carelessly, you or other vehicle occupants could be trapped and thereby injured.

Children in particular could accidentally press the electrical seat adjustment buttons and become trapped.

- ▶ While moving the seats, make sure that hands or other body parts do not get under the lever assembly of the seat adjustment system.

**⚠ WARNING** Risk of injury due to head restraints not being installed or being adjusted incorrectly

If head restraints have not been installed or have not been adjusted correctly, there is an increased risk of injury in the head and neck area, e.g. in the event of an accident or when braking.

- ▶ Always drive with the head restraints installed.
- ▶ Before driving off, make sure for every vehicle occupant that the center of the head restraint supports the back of the head at about eye level.

Do not interchange the head restraints of the front and rear seats. Otherwise, you will not be able to adjust the height and angle of the head restraints correctly.

Adjust the head restraint fore-and-aft position so that it is as close as possible to the back of your head.

**⚠ WARNING** Risk of injury or death due to an incorrect seat position

The seat belt does not offer the intended level of protection if you have not moved the seat backrest to an almost vertical position.

In particular, you could slip beneath the seat-belt and become injured.

- ▶ Adjust the seat properly before beginning your journey.
- ▶ Always ensure that the seat backrest is in an almost vertical position and that the shoulder belt is routed across the center of your shoulder.

**⚠ WARNING** Risk of injury due to excessive load on the grab handles

If you apply your full body weight to the grab handle or pull it abruptly, the grab handle may be damaged or come loose from its anchorage. This may result in injuries.

- ▶ Use the grab handles only to stabilize the seating position or to assist in getting in and out of the seat.

**⚠ WARNING** Risk of potentially fatal injuries due to objects trapped under the front passenger seat

Objects trapped under the front passenger seat may interfere with the function of the



automatic front passenger air bag shutoff or damage the system.

- ▶ Do not stow any objects under the front passenger seat.
- ▶ When the front passenger seat is occupied, ensure that no objects have become trapped beneath the front passenger seat.

### Adjusting the seat fore-and-aft position

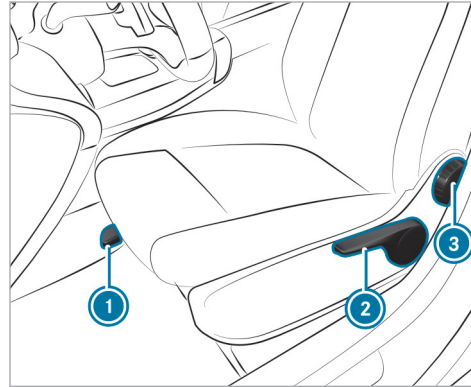

- ▶ Lift lever ① and slide the seat into the desired position.
- ▶ Make sure that the seat is engaged.
- ▶ **To adjust the seat height:** push or pull lever ② until the desired position has been reached.

- ▶ **To adjust the seat backrest inclination:** turn handwheel ③ forwards and backwards until the desired position has been reached.

### Adjusting the front seat mechanically (with Seat Comfort Package)

**⚠ WARNING** Risk of becoming trapped if the seats are adjusted by children

Children could become trapped if they adjust the seats, particularly when unattended.

- ▶ When leaving the vehicle, always take the SmartKey with you and lock the vehicle.
- ▶ Never leave children unattended in the vehicle.

This also applies to the Digital Vehicle Key.

**⚠ WARNING** Risk of becoming trapped when adjusting the seat

When you adjust a seat, you or other vehicle occupants could become trapped, e.g. on the seat guide rail.

- ▶ When adjusting a seat, make sure that no one has any part of their body within the sweep of the seat.

Observe the safety notes on "Airbags" and "Children in the vehicle".

**⚠ WARNING** Risk of accident due to the driver's seat not being engaged

The driver's seat may move unexpectedly while driving.

This could cause you to lose control of the vehicle.

- ▶ Always make sure that the driver's seat is engaged before starting the vehicle.

**⚠ WARNING** Risk of accident due to adjusting the vehicle settings while the vehicle is in motion

You could lose control of the vehicle in the following situations in particular:

- If you adjust the driver's seat, the head restraint, the steering wheel or the mirror while the vehicle is in motion
- If you fasten your seat belt while the vehicle is in motion

- ▶ Before starting the vehicle: in particular, adjust the driver's seat, head restraint, steering wheel and mirror, and fasten your seat belt.

**⚠ WARNING** Risk of becoming trapped if the seat height is adjusted carelessly

If you adjust the seat height carelessly, you or other vehicle occupants could be trapped and thereby injured.

Children in particular could accidentally press the electrical seat adjustment buttons and become trapped.

- ▶ While moving the seats, make sure that hands or other body parts do not get under the lever assembly of the seat adjustment system.

**⚠ WARNING** Risk of injury due to head restraints not being installed or being adjusted incorrectly

If head restraints have not been installed or have not been adjusted correctly, there is an increased risk of injury in the head and neck area, e.g. in the event of an accident or when braking.

- ▶ Always drive with the head restraints installed.
- ▶ Before driving off, make sure for every vehicle occupant that the center of the head restraint supports the back of the head at about eye level.

Do not interchange the head restraints of the front and rear seats. Otherwise, you will not be able to adjust the height and angle of the head restraints correctly.

Adjust the head restraint fore-and-aft position so that it is as close as possible to the back of your head.

**⚠ WARNING** Risk of injury or death due to an incorrect seat position

The seat belt does not offer the intended level of protection if you have not moved the seat backrest to an almost vertical position.

In particular, you could slip beneath the seat-belt and become injured.

- ▶ Adjust the seat properly before beginning your journey.
- ▶ Always ensure that the seat backrest is in an almost vertical position and that the shoulder belt is routed across the center of your shoulder.

**⚠ WARNING** Risk of injury due to excessive load on the grab handles

If you apply your full body weight to the grab handle or pull it abruptly, the grab handle may be damaged or come loose from its anchorage. This may result in injuries.

- ▶ Use the grab handles only to stabilize the seating position or to assist in getting in and out of the seat.

**⚠ WARNING** Risk of potentially fatal injuries due to objects trapped under the front passenger seat

Objects trapped under the front passenger seat may interfere with the function of the automatic front passenger air bag shutoff or damage the system.

- ▶ Do not stow any objects under the front passenger seat.
- ▶ When the front passenger seat is occupied, ensure that no objects have become trapped beneath the front passenger seat.

### Adjusting the seat fore-and-aft position

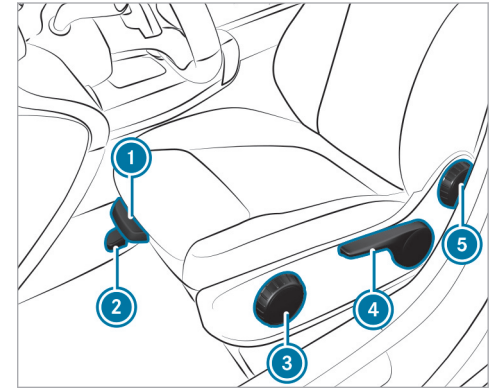

- ▶ Lift lever ② and slide the seat into the desired position.
- ▶ Make sure that the seat is engaged.
- ▶ **To adjust the seat cushion length (driver's seat only):** lift lever ① and slide the front section of the seat cushion forwards or backwards.

- ▶ **To adjust the seat cushion inclination:** turn handwheel ③ forwards and backwards until the desired position has been reached.
- ▶ **To adjust the seat height:** push or pull lever ④ until the desired position has been reached.
- ▶ **To adjust the seat backrest inclination:** turn handwheel ⑤ forwards and backwards until the desired position has been reached.

### Adjusting the front seat electrically

You can adjust the seats when the vehicle is switched off.

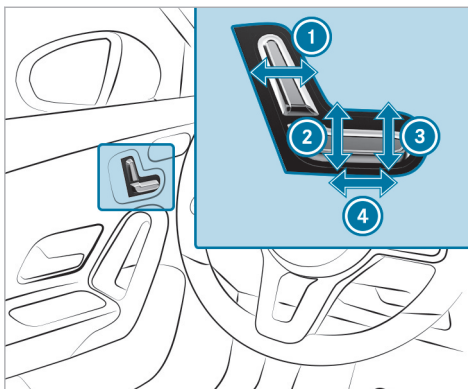

- ① Seat backrest inclination
  - ② Seat height
  - ③ Seat cushion inclination
  - ④ Seat fore-and-aft position
- ▶ Save the settings with the memory function (→ page 106).

### Adjusting the 4-way lumbar support

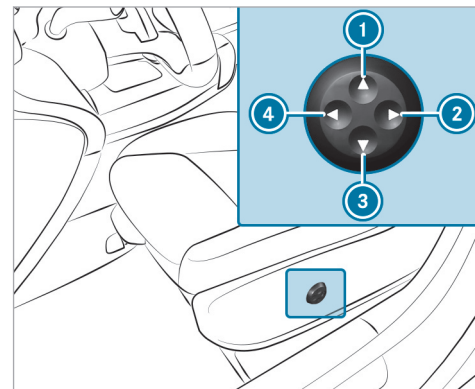

- ① Higher
  - ② Softer
  - ③ Lower
  - ④ Firmer
- ▶ Use buttons ① to ④ to adjust the contour of the backrest.

## Head restraints

### Adjusting the front seat head restraints manually

**⚠ WARNING** Risk of accident due to adjusting the vehicle settings while the vehicle is in motion

You could lose control of the vehicle in the following situations in particular:

- If you adjust the driver's seat, the head restraint, the steering wheel or the mirror while the vehicle is in motion
  - If you fasten your seat belt while the vehicle is in motion
- ▶ Before starting the vehicle: in particular, adjust the driver's seat, head restraint, steering wheel and mirror, and fasten your seat belt.

**⚠ WARNING** Risk of injury due to head restraints not being installed or being adjusted incorrectly

If head restraints have not been installed or have not been adjusted correctly, there is an increased risk of injury in the head and neck area, e.g. in the event of an accident or when braking.

- ▶ Always drive with the head restraints installed.
- ▶ Before driving off, make sure for every vehicle occupant that the center of the head restraint supports the back of the head at about eye level.

Do not interchange the head restraints of the front and rear seats. Otherwise, you will not be able to adjust the height and angle of the head restraints correctly.

Adjust the head restraint fore-and-aft position so that it is as close as possible to the back of your head.

For vehicles with sports seats, it is not possible to adjust the front head restraints.

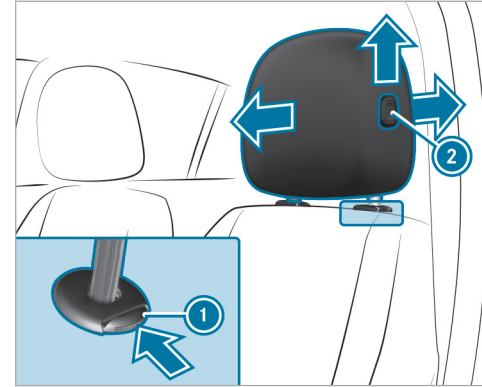

- ▶ **To raise:** pull the head restraint up.
- ▶ **To lower:** press release knob ① in the direction of the arrow and push the head restraint down.
- ▶ **To move forwards:** press release knob ② and pull the head restraint forwards.
- ▶ **To move backwards:** press release knob ② and push the head restraint backwards.

### Adjusting the head restraints of the rear seats manually

In vehicles with sports seats, it is not possible to adjust the outer head restraints.

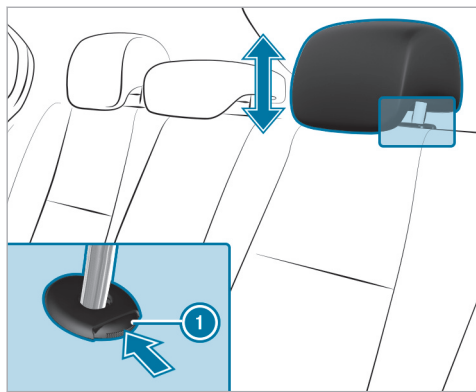

- ▶ **To raise:** pull the head restraint up.
- ▶ **To lower:** press release knob ① and push the head restraint down.

### Installing/removing the rear seat head restraints

#### Removing

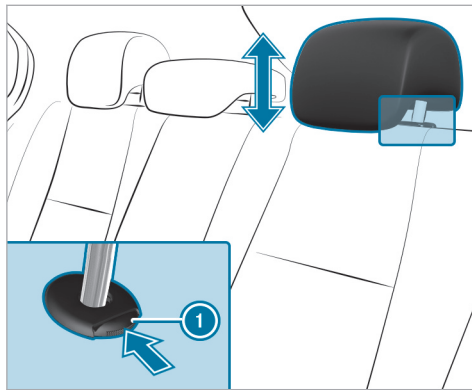

- ▶ Release the rear seat backrest and fold it forwards slightly (→ page 110).
- ▶ Pull the head restraint upwards as far as it will go.

- ▶ Push release knob ① in the direction of the arrow and pull out the head restraint.

#### Installing

- ▶ Insert the head restraint such that the notches on the bar are on the left when viewed in the direction of travel.
- ▶ Push the head restraint down until it engages.
- ▶ Fold the rear seat backrest back until it engages.

#### Setting automatic seat adjustment

- ⚠ **WARNING** Risk of becoming trapped during adjustment of the driver's seat after calling up a driver profile

Selecting a user profile may trigger an adjustment of the driver's seat to the position saved under the user profile. You or other vehicle occupants could be injured in the process.

- ▶ Make sure that when the position of driver's seat is being adjusted using the mul-

multimedia system, no people or body parts are in the seat's range of movement.

If there is a risk of someone becoming trapped, immediately stop the adjustment process by:

▶ a) Pressing the warning message on the central display.

or

▶ b) Pressing a position button of the memory function or a seat adjustment switch in the driver's door.  
The adjustment process is stopped.

Multimedia system:

→  ▶▶ Comfort ▶▶ Seat  
▶▶ Automatic Seat Positioning

### Manually adjusting driver's seat and steering wheel position to body size

The vehicle calculates a suitable driver's seat and steering wheel position on the basis of the driver's body size and sets this directly.

- ▶ **To set the unit of measurement:** select **cm** or **ft/in**.
- ▶ Set the size using the scale.
- ▶ Select **Start Positioning**.  
The driver's seat and steering wheel position is adjusted to the body size that has been set.
- ① You can also configure these settings via the Mercedes me user account for your user profile. By synchronizing the profiles in the vehicle and the Mercedes me connect profiles, you can carry over these settings for your vehicle. Further information about synchronizing user profiles .
- ① If the driver's seat and steering wheel position calculated by the vehicle is not practical or comfortable, it can be manually adapted at any time via the control buttons.  
The outside mirrors are not set via this function. Instead, they have to be set manually via the operating switches.

### Resetting seat settings

Multimedia system:

→  ▶▶ Comfort ▶▶ Seat

- ▶ Select **Reset**.
- ▶ Select  for the desired seat.  
The settings for the selected seat are reset.

### Switching the seat heating on/off

**⚠ WARNING** Risk of burns due to repeatedly switching on the seat heating

Repeatedly switching on the seat heating can cause the seat cushion and seat backrest padding to become very hot.

In particular, the health of persons with limited temperature sensitivity or a limited ability to react to high temperatures may be affected or they may even suffer burn-like injuries.

- ▶ Do not repeatedly switch on the seat heating.

To protect against overheating, the seat heating may be temporarily deactivated after it has been switched on repeatedly.

**NOTE** Damage to the seats caused by objects or documents when the seat heating is switched on

When the seat heating is switched on, overheating may occur due to objects or documents placed on the seats, e.g. seat cushions or child seats. This could cause damage to the seat surface.

▶ Make sure that no objects or documents are on the seats when the seat heating is switched on.

#### Requirements

- The power supply is switched on.

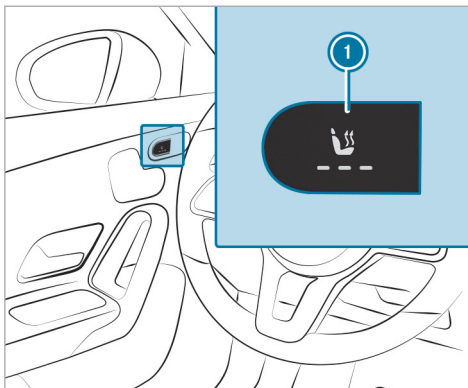

- ▶ Press button ① repeatedly until the desired heating level is set. Depending on the heating level, up to three indicator lamps will light up. If all indicator lamps are off, the seat heating is switched off.

① The seat heating will automatically switch down from the three heating levels after 8, 10 and 20 minutes until the seat heating switches off.

#### Switching the seat ventilation on/off

##### Requirements

- The power supply is switched on.

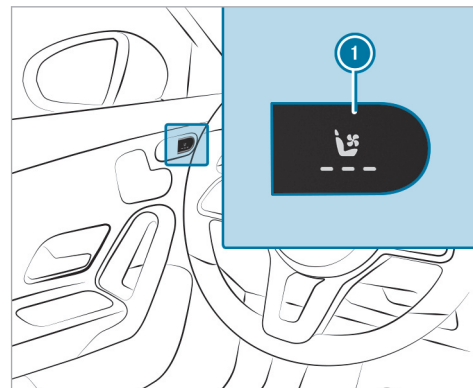

- ▶ Press button ① repeatedly until the desired blower setting has been reached. Depending on the blower setting, up to three indicator lamps will light up. If all indicator



lamps are off, the seat ventilation is switched off.

## Steering wheel

### Adjusting the steering wheel manually

**⚠ WARNING** Risk of accident due to adjusting the vehicle settings while the vehicle is in motion

You could lose control of the vehicle in the following situations in particular:

- If you adjust the driver's seat, the head restraint, the steering wheel or the mirror while the vehicle is in motion
  - If you fasten your seat belt while the vehicle is in motion
- ▶ Before starting the vehicle: in particular, adjust the driver's seat, head restraint, steering wheel and mirror, and fasten your seat belt.

**⚠ WARNING** Risk of entrapment for children when adjusting the steering wheel

Children could injure themselves if they adjust the steering wheel.

- ▶ Never leave children unattended in the vehicle.
- ▶ When leaving the vehicle, always take the key with you and lock the vehicle.

## Unlocking

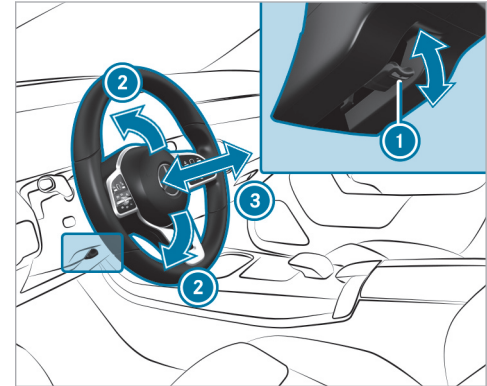

- ▶ Fold release lever ① down as far as it will go.
- ▶ Adjust height ② and distance ③ to the steering wheel.

## Locking

- ▶ Fold release lever ① up as far as it will go.

- ▶ Check and make sure that the steering column is locked by moving the steering wheel.

### Switching the steering wheel heater on/off

Depending on the vehicle version, the steering wheel heater can be switched on/off via a switch on the steering wheel.

#### Requirements

- The vehicle is switched on.

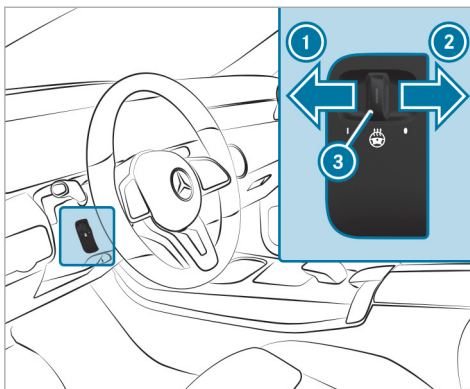

- ▶ **To switch on:** push the switch to position ①. If the indicator lamp ③ lights up, the steering wheel heater is switched on.
- ▶ **To switch off:** push the switch to position ②.

When you switch the vehicle off, the steering wheel heater will switch off.

### Easy entry and exit feature

#### Using the easy entry and exit feature

- ⚠ **WARNING** Risk of accident when pulling away during the adjustment process of the easy entry and exit feature

You could lose control of the vehicle.

- ▶ Always wait until the adjustment process is complete before driving off.

- ⚠ **WARNING** Risk of becoming trapped during adjustment of the easy entry and exit feature

You and other vehicle occupants could become trapped.

- ▶ Ensure that no-one has any body parts in the range of movement of the seat.

If there is a risk of becoming trapped by the driver's seat:

- ▶ Press the seat adjustment switch. The adjustment process will be stopped.

You can stop the adjustment process by pressing one of the memory function position switches.

**⚠ WARNING** Risk of becoming trapped if children activate the easy entry and exit feature

Children could become trapped if they activate the easy entry and exit feature, particularly when unattended.

- ▶ Never leave children unattended in the vehicle.
- ▶ When leaving the vehicle, always take the key with you and lock the vehicle.

If the easy entry and exit feature is active, the driver's seat will move into an ideal position for entering or exiting the vehicle and the seat backrest will adjust to a more upright position in the following situations:

- You switch off the vehicle when the driver's door is open.
- You open the driver's door when the vehicle is switched off.

- ① The driver's seat only moves forwards or backwards if it is not already in an ideal position for entering or exiting the vehicle. The seat backrest will then move forwards only if it is not already at the front of the backrest adjustment range.

The driver's seat will move back to the last drive position when:

- You switch the vehicle on when the driver's door is closed.
- You close the driver's door when the vehicle is switched on.

The last drive position will be saved when:

- If you switch off the vehicle.
- You call up the seat settings via the memory function.
- You save the seat settings via the memory function.

### Setting the easy entry and exit feature

#### Requirements:

- Automatic seat adjustment is activated (→ page 100).

Multimedia system:

➔  ➔ Settings ➔ Vehicle ➔ Comfort  
➔ Easy Entry And Exit Feature

- ▶ Select **Steering Wheel & Seat, Steering Wheel Only** or **Off**.

- ① If you are using an individual user profile, this information is used for the easy entry and exit feature. This will cause the driver's seat and steering wheel to move into the correct position automatically .

## Memory function

### Memory function

**⚠ WARNING** Risk of an accident if the memory function is used while driving

If you use the memory function on the driver's side while driving, you could lose control of the vehicle as a result of the adjustments being made.

- ▶ Only use the memory function on the driver's side when the vehicle is stationary.

**⚠ WARNING** Risk of entrapment when adjusting the seat with the memory function

When the memory function adjusts the seat or steering wheel, you and other vehicle occupants – particularly children – could become trapped.

- ▶ During the adjusting process of the memory function, ensure that no body

parts are in the sweep of the seat or the steering wheel.

- ▶ If somebody becomes trapped, immediately release the memory function position button. The adjustment process is stopped.

**⚠ WARNING** Danger of entrapment when memory function is activated by children

When children activate the memory function, they can get trapped, especially if they are unsupervised.

- ▶ Never leave children unattended in the vehicle.
- ▶ When leaving the vehicle, always take the key with you and lock the vehicle.

You can use the memory function when the vehicle is switched off.

Seat adjustments for up to three people can be stored and called up using the memory function.

You can save settings for the following systems:

- Seat, backrest and head restraint

- Outside mirrors

### Operating the memory function

#### Storing

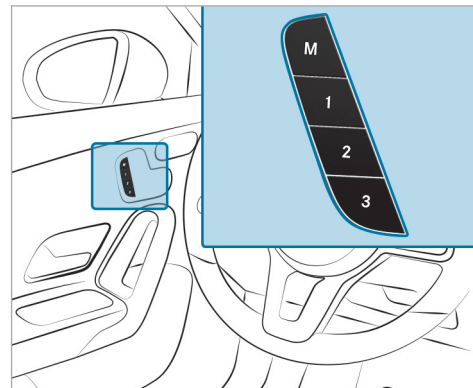

- ▶ Set the desired position for all systems.

- ▶ Briefly press memory button **M** and then press preset position **1**, **2** or **3** within three seconds.  
An acoustic signal sounds. The settings are stored.
- ▶ **To call up:** press and briefly hold one of preset position buttons **1**, **2** or **3**.  
After releasing the button, all systems are moved into the stored position.

### Stowage areas

#### Notes on loading the vehicle

#### **⚠ DANGER** Risk of exhaust gas poisoning

Combustion engines emit poisonous exhaust gases such as carbon monoxide. Exhaust gases can enter the vehicle interior if the trunk lid is open when the engine is running, especially if the vehicle is in motion.

- ▶ Always switch off the engine before opening the trunk lid.
- ▶ Never drive with the trunk lid open.

Objects in the deployment area of an air bag may prevent the air bag from functioning correctly. Also observe the notes on air bags (→ page 52).

#### **⚠ WARNING** Risk of injury from unsecured items in the vehicle

If objects, luggage or loads are not secured or not secured sufficiently, they could slip, tip over or be thrown around and thereby hit vehicle occupants.

There is a risk of injury, particularly in the event of sudden braking or a sudden change in direction.

- ▶ Always stow objects in such a way that they cannot be thrown around.
- ▶ Before the journey, secure objects, luggage or loads against slipping or tipping over.

#### **⚠ WARNING** Risk of injury due to objects being stowed incorrectly

If objects in the vehicle interior are stowed incorrectly, they can slide or be thrown around

and hit vehicle occupants. In addition, cup holders, open storage spaces and mobile phone brackets cannot always retain all objects they contain.

There is a risk of injury, particularly in the event of sudden braking or a sudden change in direction.

- ▶ Always stow objects in such a way that they cannot be thrown around in such situations.
- ▶ Always make sure that objects do not protrude from storage spaces, parcel nets or storage nets.
- ▶ Close the lockable storage spaces before starting a journey.
- ▶ Always stow and secure heavy, hard, pointed, sharp-edged, fragile or bulky objects in the trunk.

**⚠ WARNING** Risk of accident from objects in the driver's footwell and front-passenger footwell

Objects in the driver's footwell and front-passenger footwell may impede pedal travel or block a depressed pedal.

This jeopardizes the operating and road safety of the vehicle.

- ▶ Stow all objects in the vehicle securely so that they cannot get into the driver's footwell or front-passenger footwell.
- ▶ Always install the floor mats securely and as prescribed in order to ensure that there is always sufficient clearance for the pedals.
- ▶ Do not use loose floor mats and do not lay multiple floor mats on top of one another.

**Vehicles with automatic front-passenger air bag shutoff:** objects trapped under the front-passenger seat may interfere with the function of the automatic front-passenger air bag shutoff or damage the system. Please observe the notes on

the function of automatic front-passenger air bag shutoff (→ page 42).

**⚠ WARNING** - Risk of accident or injury when using the cup holder while the vehicle is moving

The cup holder cannot secure containers while the vehicle is moving.

If you use a cup holder while the vehicle is moving, the container may be flung around and liquids may be spilled. The vehicle occupants may come into contact with the liquid and if it is hot, they could be scalded. You could be distracted from traffic conditions and you may lose control of the vehicle.

- ▶ Only use the cup holder when the vehicle is stationary.
- ▶ Only use the cup holder for containers of the right size.
- ▶ Close the container, particularly if the liquid is hot.

**! NOTE** Damage to the cup holder

The cup holder can be damaged when folding back the rear armrest. When open, the cup holder can be damaged by body weight.

- ▶ The rear armrest can only be folded back when the cup holder is closed.
- ▶ Do not sit or support yourself on the cup holder when it is open.

**! NOTE** Damage to the rear armrest due to body weight

When folded out, the rear armrest can be damaged by body weight.

- ▶ Do not sit or support yourself on the rear seat armrest.

**⚠ WARNING** Risk of fire and injury from hot cigarette lighter

You can suffer burns if you touch the hot heating element or the hot socket of the cigarette lighter.

In addition, flammable materials can catch fire if:

- you drop the hot cigarette lighter.
  - children e.g. hold the hot cigarette lighter to objects.
- ▶ Always hold the cigarette lighter by the knob.
  - ▶ Always make sure that the cigarette lighter is out of the reach of children.
  - ▶ Never leave children unattended in the vehicle.

**⚠ WARNING** Risk of burns from the tailpipe and tailpipe trims

The exhaust tailpipe and tailpipe trims can become very hot. If you come into contact with these parts of the vehicle, you could burn yourself.

- ▶ Always be particularly careful around the tailpipe and the tailpipe trims and super-

▶ **vise children especially closely in this area.**

- ▶ Allow vehicle parts to cool down before touching them.

**i** Leather is a natural product. It exhibits natural surface properties, such as differences in structure, marks caused by growth and injury or subtle color differences. These surface properties are characteristics of leather and not material defects. Leather is also subject to a natural aging process during which the surface properties change.

The driving characteristics of your vehicle are dependent on the distribution of the load within the vehicle. You should bear the following in mind when loading the vehicle:

- Never exceed the gross vehicle weight rating or the gross axle weight ratings for the vehicle (with the load and including occupants). The values are specified on the vehicle identification plate on the vehicle's B-pillar.
- The load must not protrude above the upper edge of the seat backrests.

- Always place the load behind unoccupied seats if possible.
- Secure the load using the cargo tie-down rings and distribute the load evenly.

Notes on driving with a roof load

- Distribute the roof load and the load inside the vehicle evenly, placing heavy objects at the bottom. Also comply with the notes on loading the vehicle (→ page 107).
- Drive attentively and avoid abrupt starts, braking and steering as well as rapid cornering.
- When transporting roof loads and when the vehicle is fully loaded or fully occupied, select drive program **[E]** or **[C]**. These are designed to emphasize stability (→ page 148).
- i** For more information on storage compartments and stowage areas, please refer to the Digital Operator's Manual.

## Stowage spaces in the vehicle interior

### Overview of the front storage compartments

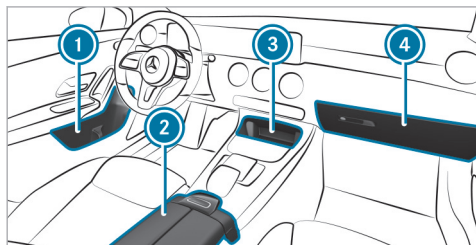

- ❶ Stowage spaces in the doors
- ❷ Storage compartment in the armrest with a multimedia and USB port
- ❸ Storage compartment in the front center console with a USB port
- ❹ Glove box

### Locking/unlocking the glove box

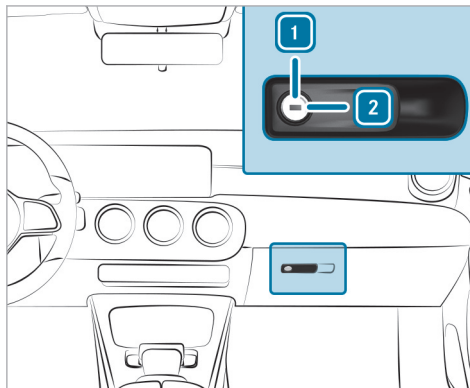

- ▶ Turn the emergency key a quarter turn clockwise **2** (to lock) or counter-clockwise **1** (to unlock).

## Through-loading feature in the rear bench seat (EASY-PACK Quickfold)

### Folding the rear seat backrest forwards

**⚠ WARNING** Risk of accident if the rear bench seat, rear seat and seat backrest are not engaged

The rear bench seat, rear seat and seat backrest may fold forwards, even when you are driving.

- As a result, the vehicle occupant will be pushed into the seat belt with increased force. The seat belt will not be able to protect as intended and could cause additional injury.
  - Objects or loads in the trunk or cargo compartment will not be restrained by the seat backrest.
- ▶ Make sure that the rear bench seat, the rear seat and the seat backrest are engaged before every trip.



If the seat backrests are not engaged and locked in place, the lock verification indicator will be red.

#### Requirements:

- To fold the center seat backrest forwards: the center seat backrest has been unlocked.

You can fold the center and outer seat backrests forwards separately.

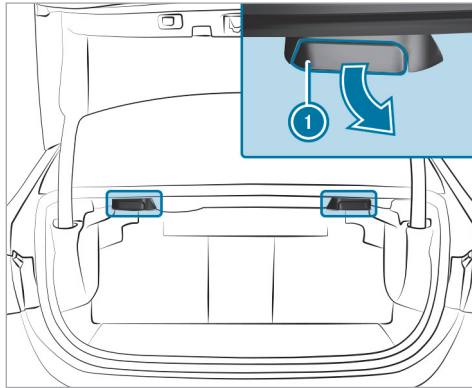

**Vehicles with a memory function:** If necessary, when the seat backrest in the rear passenger compartment is folded forward, the front seat will move forwards slightly to avoid a collision.

- ▶ If necessary, fully insert the head restraints in the rear seat backrest.

The release handles are located beneath the rear shelf.

- ▶ **To fold the left and right seat backrests forward:** pull right or left release handle ① and fold the corresponding seat backrest forwards.

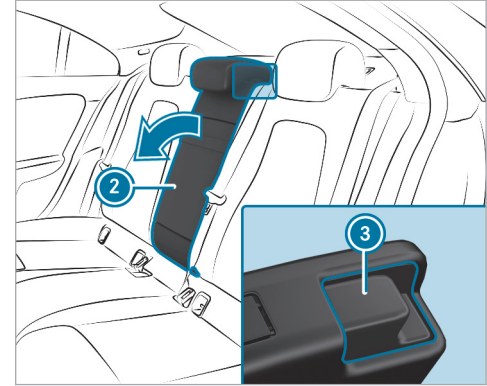

- ▶ **To fold the center seat backrest forwards:** pull release catch ③ of seat backrest ② forwards.
- ▶ Fold seat backrest ② forwards.
- ▶ Move the driver's or front passenger seat back if necessary.

### Folding the rear seat backrest back

**⚠ WARNING** Risk of becoming trapped when adjusting the seats

When you adjust a seat, you may trap yourself or a vehicle occupant.

- ▶ When adjusting a seat, make sure that no one has any body parts in the sweep of the seat.

**ⓘ NOTE** Damage caused by trapping the seat belt when folding back the seat backrest

The seat belt could become trapped and thus damaged when the seat backrest is folded back.

- ▶ Make sure that the seat belt is not trapped when folding back the seat backrest.

- ▶ Move the driver's or front passenger seat forwards, if necessary.

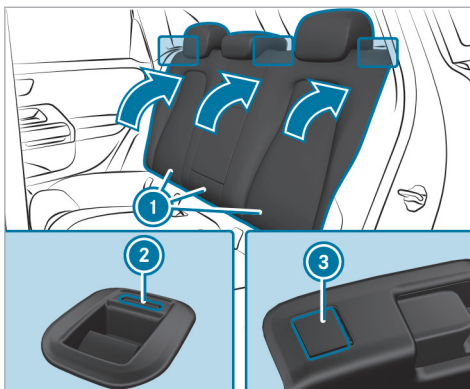

- ▶ Fold the corresponding seat backrest ① back until it engages.

**Left and right seat backrests:** if the seat backrest is not engaged and locked in place, red lock verification indicator ② will be visible.

**Center seat backrest:** if the seat backrest is not engaged and locked in place, red lock verification indicator ③ will be visible.

### Locking the release catch of the center rear seat backrest

#### Requirements:

- The left and center seat backrests are engaged and joined together.

You can lock the center seat backrest release catch if you want to secure the trunk against unauthorized access. The center seat backrest can then be folded forwards only together with the left seat backrest.

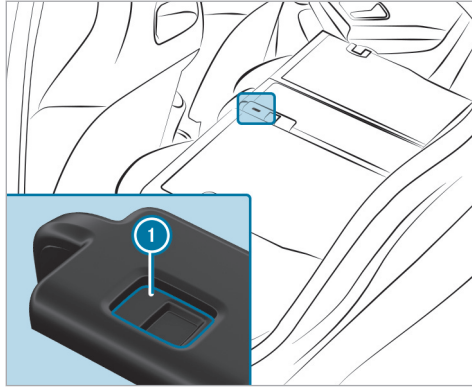

- ▶ Fold the center and left seat backrests forwards.
- ▶ **To lock or unlock:** slide catch ① upwards or downwards.

### Overview of the tie-down eyes

Observe the notes on loading the vehicle (→ page 107).

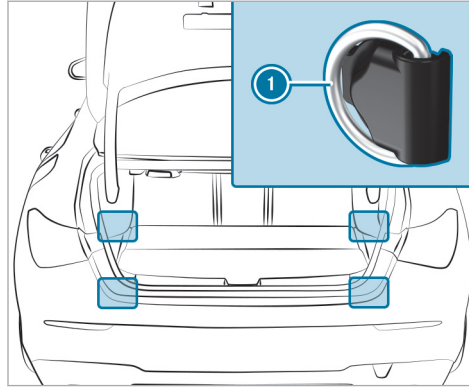

- ① Tie-down eyes (vehicles with through-loading feature in the rear bench seat)

### Attaching a roof luggage rack

**⚠ WARNING** Risk of accident due to exceeding the maximum roof load

The vehicle center of gravity and the usual driving characteristics as well as the steering and braking characteristics alter.

If you exceed the maximum roof load, the driving characteristics, as well as steering and braking, will be greatly impaired.

- ▶ Never exceed the maximum roof load and adjust your driving style.

You will find information on the maximum roof load in the "Technical data" section.

**!** **NOTE** Vehicle damage due to failure to observe the maximum permissible clearance height

If the vehicle height exceeds the maximum permissible clearance height, the roof and other vehicle parts may be damaged.

- ▶ Please observe the maximum clearance height indicated.
- ▶ If the vehicle exceeds the permissible clearance height, do not drive in.
- ▶ Take the modified vehicle height into account in the case of roof superstructures or other carrier systems.

**!** **NOTE** Vehicle damage from non-approved roof luggage racks

The vehicle could be damaged by roof luggage racks that have not been tested and approved for Mercedes-Benz.

- ▶ Use only roof luggage racks tested and approved for Mercedes-Benz.
- ▶ Depending on the vehicle equipment, ensure that the sliding sunroof can be fully raised when the roof luggage rack is installed.
- ▶ Depending on the vehicle equipment, ensure that the trunk lid can be fully

opened when the roof luggage rack is installed.

- ▶ Position the load on the roof luggage rack in such a way that the vehicle will not sustain damage even when it is in motion.

**!** **NOTE** Damage to the panorama roof with power tilt/sliding panel due to non-approved roof luggage racks

The panorama roof with power tilt/sliding panel may be damaged by the roof luggage rack if you attempt to open it when using a roof luggage rack not tested and approved for Mercedes-Benz.

- ▶ When a roof luggage rack is installed, open the panorama roof with power tilt/sliding panel only if this has been tested and approved for Mercedes-Benz.

The panorama roof with power tilt/sliding panel may be raised to allow ventilation of the vehicle interior.

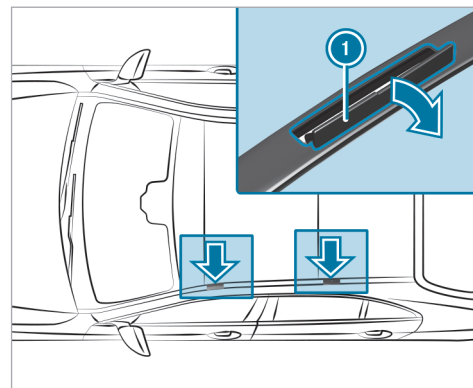

**!** **NOTE** Damage to the covers

The covers may be damaged and scratched when being opened.

- ▶ Do not use metallic or hard objects.

- ▶ Fold covers ① carefully upwards in the direction of the arrow.

- ▶ Secure the roof luggage rack to the fastening points beneath covers ①.
- ▶ Comply with the installation instructions of the roof luggage rack manufacturer.
- ▶ Secure the load on the roof luggage rack.

## Sockets

### Using the 12 V socket

#### Requirements

- Only devices up to a maximum of 180 W (15 A) are permissible.

Depending on the vehicle equipment, the vehicle has the following 12 V sockets:

- In the stowage compartment in the front center console
- In the trunk

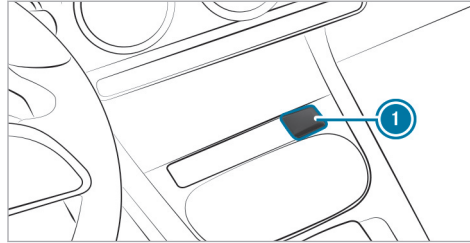

Example: 12 V socket in the stowage compartment in the front center console

- ▶ Fold up socket cap ①.
- ▶ Insert the plug of the device.

**12 V socket in the stowage compartment with cover:** if you have connected a device to the 12 V socket, leave the plug of the device in the socket and leave the cover of the stowage compartment open.

### Using the 115 V socket in the rear passenger compartment

**⚠ DANGER** Risk of fatal injuries due to a damaged connecting cable or a damaged socket

You could receive an electric shock if the connecting cable or the 115 V power socket is pulled out of the trim or is damaged or wet.

- ▶ Use only connecting cables that are dry and free of damage.
- ▶ When the vehicle is switched off, make sure that the 115 V power socket is dry.
- ▶ Immediately have the 115 V power socket checked or replaced at a qualified specialized workshop if it is damaged or has been pulled out of the trim.
- ▶ Never plug the connecting cable into a 115 V power socket that is damaged or has been pulled out of the trim.

**⚠ DANGER** Risk of death due to using the socket incorrectly

In particular, you could receive an electric shock:

- If you touch the inside of the socket
- If you insert unsuitable devices or objects into the socket

- ▶ Do not touch the inside of the socket.
- ▶ Only connect suitable devices to the socket.

Make sure that no liquids get into the 115 V socket.

When the 115 V socket is not in use, keep the socket flap closed.

#### Requirements

- Only connect devices with a suitable plug which conforms to the standards specific to the country you are in.
- Only connect devices up to a maximum of 150 W.
- Do not use multiple socket outlets.

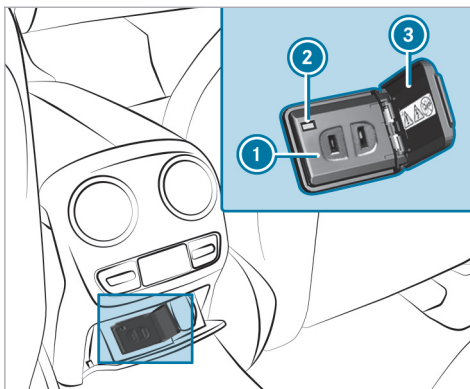

- ▶ Open socket flap ③.
- ▶ Insert the plug of the device into 115 V socket ①. When the on-board electrical system voltage is sufficient, indicator lamp ② lights up.

#### USB port in the rear passenger compartment

**i** Depending on the vehicle equipment, the design of the stowage compartment and the number of USB ports in the rear center console may vary.

When the vehicle is switched on, you can charge a USB device, such as a mobile phone, at the USB port using a suitable charging cable.

#### Wireless charging of the mobile phone and connection with the exterior antenna

##### Notes on wireless charging of a mobile phone

**⚠ WARNING** Risk of injury due to objects being stowed incorrectly

If objects in the vehicle interior are stowed incorrectly, they can slide or be thrown around and hit vehicle occupants. In addition, cup holders, open stowage spaces and mobile phone receptacles cannot always retain all objects within.

There is a risk of injury, particularly in the event of sudden braking or a sudden change in direction.

- ▶ Always stow objects so that they cannot be thrown around in such situations.
- ▶ Always make sure that objects do not protrude from stowage spaces, parcel nets or stowage nets.
- ▶ Close the lockable stowage spaces before starting a journey.
- ▶ Always stow and secure heavy, hard, pointed, sharp-edged, fragile or bulky objects in the trunk/cargo compartment.

Observe the notes on loading the vehicle.

**⚠ WARNING** Risk of fire from placing objects in the mobile phone storage compartment

Placing other objects in the mobile phone storage compartment could constitute a fire hazard.

- ▶ Apart from a mobile phone, do not place any other objects in the mobile phone storage compartment, especially those made of metal.

**!** **NOTE** Damage to objects caused by placing them in the mobile phone storage compartment

If objects are placed in the mobile phone storage compartment, these may be damaged by electromagnetic fields.

- ▶ Do not place credit cards, storage media, ski passes or other objects sensitive to electromagnetic fields in the mobile phone storage compartment.

**!** **NOTE** Damage to the mobile phone stowage compartment caused by liquids

If liquids enter the mobile phone storage compartment, the compartment may be damaged.

- ▶ Ensure that no liquids enter the mobile phone storage compartment.

Please observe the following notes on wireless charging of a mobile phone.

- Depending on the vehicle equipment, the mobile phone is connected to the vehicle's exterior antenna via the charging module.
- The charging function and wireless connection of the mobile phone to the vehicle's exterior antenna are only available if the vehicle is switched on.
- It may not be possible to charge small mobile phones in every position in the mobile phone stowage compartment.
- It may not be possible to charge mobile phones that are too large to lie flat in the mobile phone stowage compartment, or to connect them with the vehicle's exterior antenna.
- The mobile phone may heat up during the charging process. In particular, this can depend on the applications (apps) that are open in the background.
- To ensure more efficient charging and connection with the vehicle's exterior antenna, remove the protective cover from the mobile

phone. This does not apply to protective covers which are designed for wireless charging.

### Charging a mobile phone wirelessly

#### Requirements

- The mobile phone is suitable for wireless charging.

A list of compatible mobile phones can be found at: <https://www.mercedes-benz-mobile.com>.

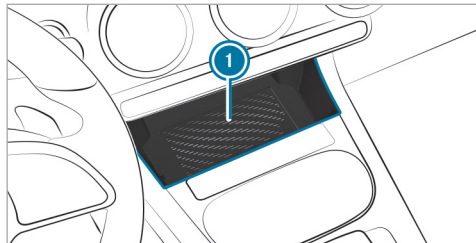

- ▶ Place the mobile phone as close to the center of the marked surface on mat ① as possible with the display facing upwards. When a message is shown in the multimedia system, the mobile phone is being charged. Malfunctions during the charging process are shown in the central display.

- ① The mat can be removed for cleaning, e.g. using clean, lukewarm water.

#### Stowage compartment without cover

Make sure the mobile phone is properly stored and secured to prevent it from falling out while you are driving.

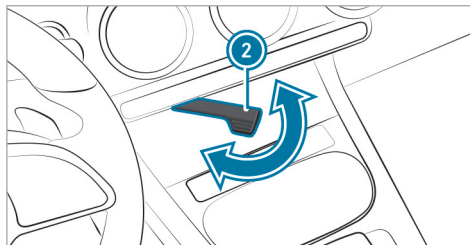

- ▶ **To secure the mobile phone:** swing lever ② out.

### Installing/removing the floor mats

**⚠ WARNING** Risk of accident due to objects in the driver's footwell

Objects in the driver's footwell may impede pedal travel or block a depressed pedal.

This jeopardizes the operating and road safety of the vehicle.

- ▶ Stow all objects in the vehicle securely so that they cannot get into the driver's footwell.
- ▶ Always install the floor mats securely and as prescribed in order to ensure that there is always sufficient room for the pedals.
- ▶ Do not use loose floor mats and do not place floor mats on top of one another.



### Installing floor mats

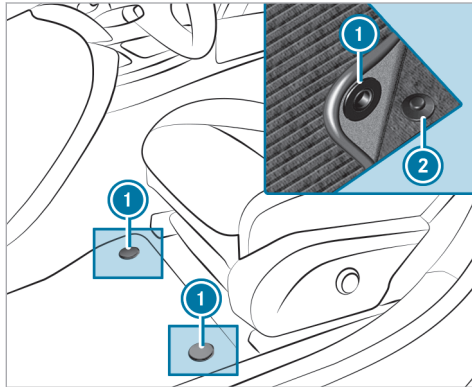

- ▶ Remove the floor mat.

- ▶ Slide the corresponding seat backwards and lay the floor mat in the footwell.
- ▶ Press studs ① onto holders ②.
- ▶ Adjust the corresponding seat.

### Removing floor mats

- ▶ Pull the floor mat off holders ②.

## Exterior lighting

### Information about lighting systems and your responsibility

The various lighting systems of the vehicle are only aids. The driver of the vehicle is responsible for correct vehicle illumination in accordance with the prevailing light and visibility conditions, legal requirements and traffic situation.

## Light switch

### Operating the light switch

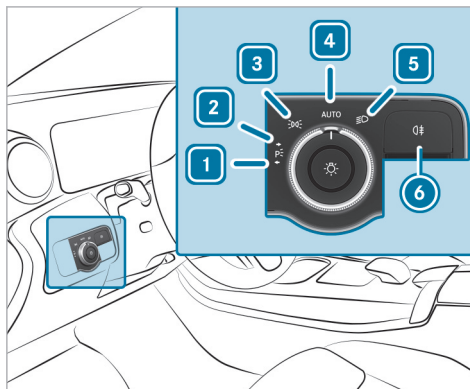

- 1 Left-hand parking lights
- 2 Right-hand parking lights
- 3 Standing lights and license plate lamp
- 4 Automatic driving lights (preferred light switch position)

- 5 Low beam / high beam
- 6 Switches the rear fog light on/off.

When low beam is activated, the indicator lamp for the standing lights will be deactivated and replaced by the low-beam indicator lamp.

▶ Always park your vehicle safely using sufficient lighting, in accordance with the relevant legal stipulations.

**!** **NOTE** Battery discharging by operating the parking lamps

Do not have the parking lamps switched on over a period of several hours.

If the battery is insufficiently charged, the standing lights or parking lights will be switched off automatically to facilitate the next engine start.

The exterior lighting (except standing and parking lights) will switch off automatically when the driver's door is opened.

- Observe the notes on locator lighting (→ page 124).

### Automatic driving lights function

When the vehicle is switched on, the side lamps, low beam and daytime running lights will be switched on automatically depending on the ambient light.

**⚠ WARNING** Risk of accident when the low beam is switched off in poor visibility



When the light switch is set to **AUTO**, the low beam may not be switched on automatically if there is fog, snow or other causes of poor visibility such as spray.

▶ In such cases, turn the light switch to .

The automatic driving lights are only an aid. You are responsible for the vehicle lighting.

### Switching the rear fog light on/off

#### Requirements

- The light switch is in the  or **AUTO** position.
- ▶ Press button .

Please observe the country-specific laws on the use of rear fog lamps.

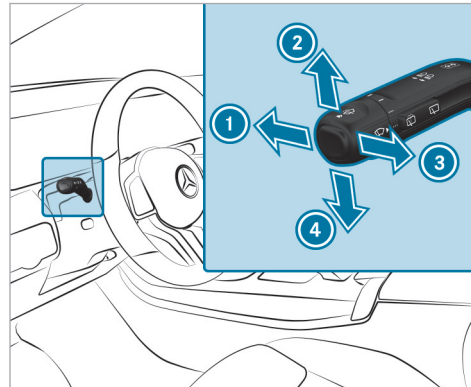

### Operating the combination switch for the lights



- 1 High beam
- 2 Turn signal light, right
- 3 Headlamp flashing
- 4 Turn signal light, left

- ▶ Use the combination switch to select the desired function.

### Switching on high beam

- ▶ Turn the light switch to the  or **AUTO** position.
- ▶ Push the combination switch in the direction of arrow 1. When high beam is activated, the indicator lamp for low beam  will be deactivated and replaced by the indicator lamp for high beam .

### Switching off high beam

- ▶ Push the combination switch in the direction of arrow 1 or pull it in the direction of arrow 3.

### Headlamp flashing

- ▶ Pull the combination switch in the direction of arrow 3.

### Turn signals

- ▶ **To indicate briefly:** push the combination switch briefly to the point of resistance in the direction of arrow ② or ④. The corresponding turn signal light will flash three times.
- ▶ **To indicate permanently:** push the combination switch beyond the point of resistance in the direction of arrow ② or ④.

### Activating/deactivating the hazard warning lights

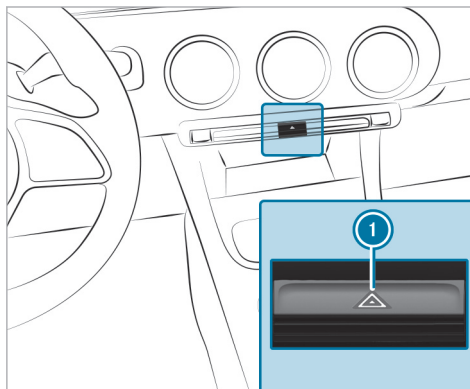

- ▶ Press button ①.

The hazard warning lights will switch on automatically if:

- the air bag has been deployed.

### Cornering light

#### Cornering light function

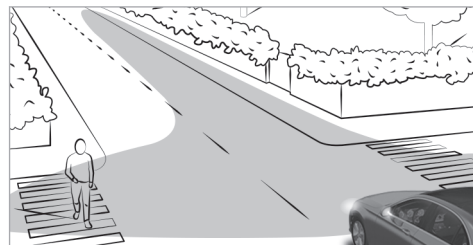

The cornering light improves the illumination of the road over a wide angle in the turning direction, enabling better visibility on tight bends, for example. The cornering light will be activated only when low beam is switched on.

The function will be active in the following cases:

- At speeds below 25 mph (40 km/h) when the turn signal light is switched on or the steering wheel is turned

- At speeds between 25 mph (40 km/h) and 43 mph (70 km/h) and when the steering wheel is turned

### Active headlamps

#### Active headlamps function

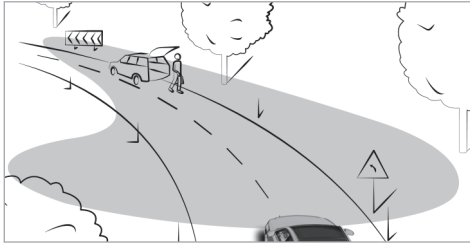

- The headlamps will follow your steering movements.
- Relevant areas will be better illuminated during a journey.

The functions will be active when high beam is switched on.

### Adaptive Highbeam Assist

#### Adaptive Highbeam Assist function

**⚠ WARNING** Risk of accident despite Adaptive Highbeam Assist

Adaptive Highbeam Assist does not react to:

- Road users without lights, e.g. pedestrians
- Road users with poor lighting, e.g. cyclists
- Road users whose lighting is obstructed, e.g. by a barrier

On very rare occasions, Adaptive Highbeam Assist may fail to recognize other road users with their own lighting, or may recognize them too late.

In these, or in similar situations, the automatic high beam will not be deactivated or will be activated despite the presence of other road users.

- ▶ Always observe the road and traffic conditions carefully and switch off the high beam in good time.

Adaptive Highbeam Assist cannot take into account road, weather or traffic conditions.

Detection may be restricted in the following cases:

- In poor visibility, e.g. fog, heavy rain or snow
- if there is dirt on the sensors or the sensors are obscured

Adaptive Highbeam Assist is only an aid. You are responsible for adjusting the vehicle's lighting to the prevailing light, visibility and traffic conditions.

- ⓘ Adaptive Highbeam Assist is an on-demand feature (→ page 21).

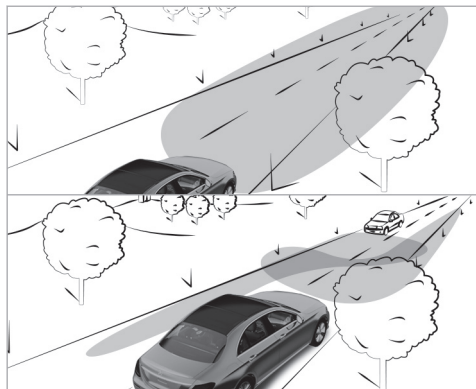

Adaptive Highbeam Assist automatically switches between the following types of light:

- Low-beam headlamps
- High beam

At speeds greater than 19 mph (30 km/h):

- If no other road users are detected, high beam will switch on automatically.

High beam will switch off automatically in the following cases:

- At speeds below 16 mph (25 km/h)
  - If other road users are detected
  - If street lighting is sufficient
- i** The system's optical sensor is located behind the windshield near the overhead control panel.

### Switching Adaptive Highbeam Assist on/off

#### Switching on

- ▶ Turn the light switch to the **AUTO** position.
- ▶ Switch on high beam using the combination switch.  
If Adaptive Highbeam Assist is activated, the  indicator lamp will light up on the driver's display.

#### Switching off

- ▶ Switch off high beam using the combination switch.

### Setting the exterior lighting switch-off delay time

Multimedia system:

- ▶  **Settings** ▶ **Light**
- ▶ **Interior/Exterior Lighting**
- ▶ **External Lighting Delay**

- ▶ Set a switch-off delay time.  
When the vehicle's engine is switched off, the exterior lighting will be activated for the set time.

### Switching locator lighting on/off

Multimedia system:

- ▶  **Settings** ▶ **Light**
- ▶ **Interior/Exterior Lighting**

- ▶ Activate or deactivate **Locator Lighting**.





When the function is activated, the exterior lighting will light up for 40 seconds after the vehicle is unlocked or the driver's door is opened when the vehicle is parked and not locked. When you start the vehicle, the locator lighting is switched off and automatic driving lights are activated.

## Interior lighting

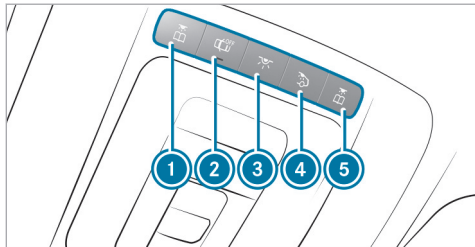
### Adjusting the interior lighting

#### Front overhead control panel



- ①  Front left reading lamp
- ②  Automatic interior lighting control
- ③  Front interior lighting
- ④  Rear interior lighting
- ⑤  Front right reading lamp

▶ **To switch on or off:** press button ① - ⑤ accordingly.

#### Operating unit inside the grab handle (rear passenger compartment)

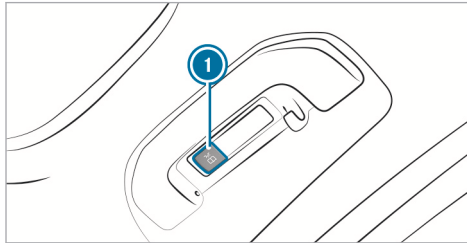

- ①  Rear reading lamp

▶ **To switch on or off:** press the ① button.

### Adjusting the ambient lighting

Multimedia system:

→  ▶ **Comfort** ▶ **Ambient Light**

#### Setting the color

- ▶ Select **Color**.
- ▶ Select **Monochrome** or **Multi-color**.

- ▶ Set the desired color or color scheme.

#### Adjusting the brightness

- ▶ Select **Brightness**.
- ▶ Adjust the brightness.
- ⓘ Depending on the ambient light, the ambient lighting will automatically switch between day and night modes.

#### Activating the brightness for zones

- ▶ Select **Brightness**.
- ▶ Switch off **Link Zones**.  
The **Direct**, **Indirect** and **Accents** zones can be set separately.

#### Activating effects

- ▶ Select **Effects**.
- ▶ Activate the desired effect.
- ⓘ Depending on the vehicle equipment, different effects are available.

#### Multi-color Animation

- The chosen color combination will change at predefined intervals.

### Climate

- If changes are made to the temperature setting in the vehicle, the color of the ambient lighting will change briefly.

### Greeting

- When you get into the vehicle, a special color animation will play.

### Switching the interior lighting switch-off delay time on/off

Multimedia system:

-  » Settings » Light
- » Interior/Exterior Lighting
- » Interior Lighting Delay



- ▶ Activate or deactivate **Interior Lighting Delay**. If this function is active, the interior lighting will be switched on for a short time after the end of the journey.

### Windshield wiper and windshield washer system

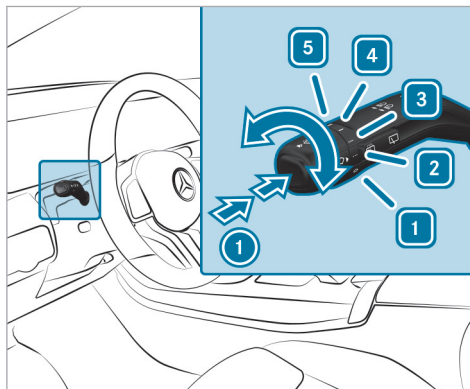
#### Switching the windshield wipers on/off



- |   |      |                            |
|---|------|----------------------------|
| 1 | 0    | Windshield wipers off      |
| 2 | ...  | Automatic wiping, normal   |
| 3 | .... | Automatic wiping, frequent |
| 4 | —    | Continuous wiping, slow    |
| 5 | =    | Continuous wiping, fast    |

- ▶ Turn the combination switch to the corresponding position **1** - **5**.
- ▶  **Single wipe:** press button **1** as far as the point of resistance.
- ▶  **Wiping with washer fluid:** press button **1** beyond the point of resistance.
- ⓘ Observe the notes on washing the vehicle in a car wash (→ page 282).

### Changing the windshield wiper blades

**⚠ WARNING** Risk of becoming trapped if the windshield wipers are switched on while wiper blades are being replaced

If the windshield wipers begin to move while you are changing the wiper blades, you can be trapped by the wiper arm.

- ▶ Always switch off the windshield wipers and vehicle before changing the wiper blades.



### Moving the wiper arms into the replacement position

- ▶ Switch the vehicle on and then off again immediately.
- ▶ Within around 15 seconds, press and hold the  button on the combination switch for approximately three seconds (→ page 126). The wiper arms will move into the replacement position.

### Removing the wiper blades

- ▶ Fold the wiper arms away from the windshield.

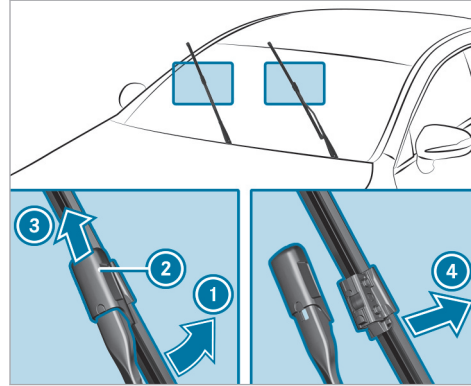

- ▶ Hold the wiper arm with one hand. With the other hand, turn the wiper blade away from the wiper arm in the direction of arrow ① as far as it will go.
- ▶ Slide catch ② in the direction of arrow ③ until it engages in the removal position.
- ▶ Remove the wiper blade from the wiper arm in the direction of arrow ④.

### Installing the wiper blades

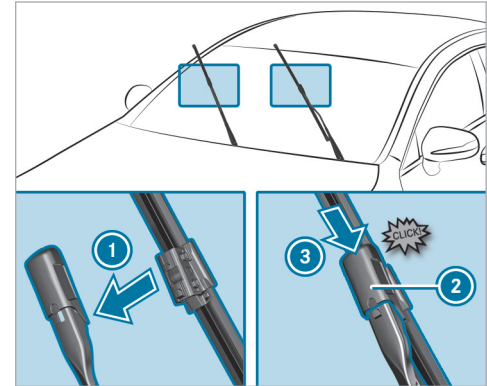

- ▶ Insert the new wiper blade into the wiper arm in the direction of arrow ①.
- ▶ Slide catch ② in the direction of arrow ③ until it engages in the locking position.
- ▶ Make sure that the wiper blade is seated correctly.
- ▶ Fold the wiper arms back onto the windshield.

- ▶ Switch on the vehicle.
  - ▶ Press the  button on the combination switch (→ page 126). The wiper arms will return to their original positions.
  - ▶ Switch off the vehicle.
- ⓘ Check the condition of the wiper blades regularly and replace them in the event of visible damage or ongoing smearing.

### Maintenance display

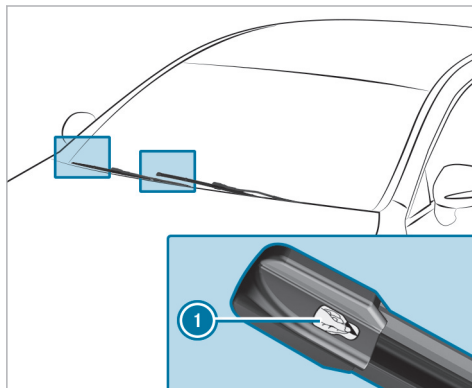

- ▶ Remove protective film ⓘ from the maintenance displays on the tips of the newly installed wiper blades.

When the color of the maintenance displays changes from black to yellow, replace the wiper blades.

- ⓘ The duration until the color changes varies depending on the usage conditions.

### Mirrors

#### Operating the outside mirrors

- ⚠ WARNING** Risk of accident due to adjusting the vehicle settings while the vehicle is in motion

You could lose control of the vehicle in the following situations in particular:

- If you adjust the driver's seat, the head restraint, the steering wheel or the mirror while the vehicle is in motion
- If you fasten your seat belt while the vehicle is in motion

- ▶ Before starting the vehicle: in particular, adjust the driver's seat, head restraint, steering wheel and mirror, and fasten your seat belt.

**⚠ WARNING** Risk of accident due to misjudgment of distance when using the front-passenger mirror

The outside mirror on the front passenger side reflects objects on a smaller scale. The objects in view are in fact closer than they appear.

▶ Therefore, always look over your shoulder to check the actual distance between you and the road users traveling behind you.

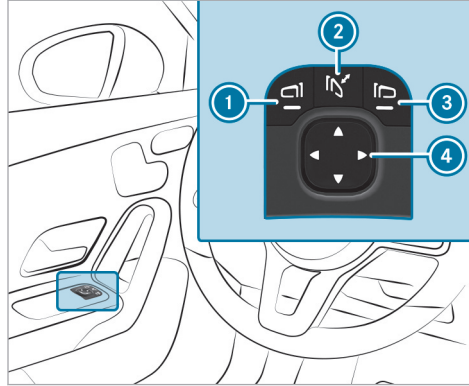

▶ **To fold in or out:** briefly press button ②.

▶ **To adjust:** use button ① or ③ to select the outside mirror to be adjusted.

▶ Use button ④ to adjust the position of the mirror glass.

ⓘ If the battery has been disconnected or completely discharged, you will have to reset the

outside mirrors. Only then will the automatic mirror folding function work properly.

▶ **To reset:** briefly press button ②.

An outside mirror that has been pushed out of position can be engaged in position again as follows:

▶ **Vehicles without electrically folding outside mirrors:** manually move the outside mirror into the correct position.

▶ **Vehicles with electrically folding outside mirrors:** press and hold button ②. You will hear a click and the mirror will audibly click into place. The outside mirror will now be set to the correct position.

#### Automatic anti-glare mirrors function

**⚠ WARNING** Risk of acid burns and poisoning due to the anti-glare mirror electrolyte

Electrolyte may escape if the glass in an automatic anti-glare mirror breaks.

The electrolyte is hazardous to health and causes irritation. It must not come into contact with your skin, eyes, respiratory organs or clothing or be swallowed.

▶ If you come into contact with electrolyte, observe the following:

- Immediately rinse the electrolyte from your skin with water and seek medical attention.
- If electrolyte comes into contact with your eyes, immediately rinse them thoroughly with clean water and seek medical attention.
- If the electrolyte is swallowed, immediately rinse your mouth out thoroughly. Do not induce vomiting. Seek medical attention immediately.
- Immediately change out of clothing which has been contaminated with electrolyte.
- If an allergic reaction occurs, seek medical attention immediately.

The inside rearview mirror and the outside mirror on the driver's side will automatically go into anti-glare mode if light from a headlamp hits the sensor on the inside rearview mirror.

#### System limits

The system will not go into anti-glare mode if:

- The vehicle is switched off.
- Reverse gear is engaged.
- The interior lighting is switched on.

#### Front-passenger outside mirror parking position function

The parking position makes parking easier.

The front-passenger outside mirror will swivel downwards in the direction of the rear wheel on the front passenger's side when:

- The parking position is stored (→ page 131).
- The front-passenger mirror is selected.
- Reverse gear is engaged.

The front-passenger outside mirror will move back to its original position when:

- You shift the transmission to another transmission position.
- You are traveling at a speed greater than 9 mph (15 km/h).
- You press the button for the outside mirror on the driver's side.

### Storing the parking position of the front-passenger outside mirror using reverse gear

#### Storing

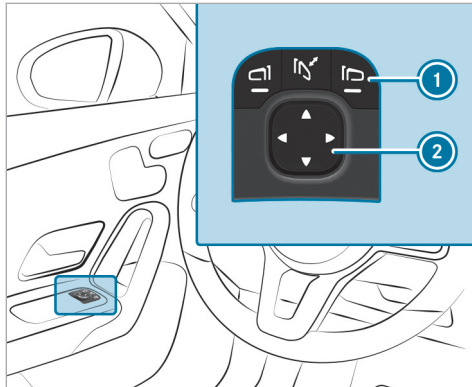

- ▶ Press button ① to select the front-passenger outside mirror.
- ▶ Engage reverse gear.

- ▶ Move the front-passenger outside mirror into the desired parking position using button ②.

#### Calling up

- ▶ Press button ① to select the front-passenger outside mirror.
- ▶ Engage reverse gear.  
The front-passenger outside mirror will move into the stored parking position.

### Activating/deactivating the automatic mirror folding function

Multimedia system:

- ▶ ▶ Settings ▶ Vehicle
- ▶ Open/Close
- ▶ Activate or deactivate Automatic Mirror Folding.

## Overview of climate control systems

### Notes on climate control





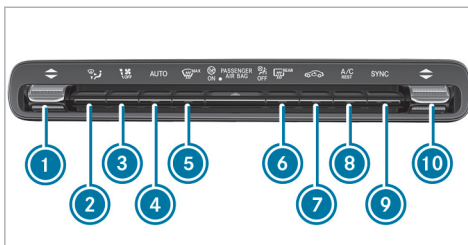

For the air-conditioning system, pollution level monitoring and air filtration to function correctly, an interior air filter must always be used. Make sure that the filter is installed correctly. Use filters recommended and approved by Mercedes-Benz. Always have maintenance work carried out at a qualified specialist workshop.



### Overview of the air conditioning control panel

The indicator lamps on the buttons indicate that the corresponding functions are activated.





THERMOTRONIC air conditioning control panel

- ①  Sets the temperature on the driver's side
- ②  Sets the air distribution
- ③  Sets the airflow or switches off climate control
- ④ **AUTO** Sets climate control to automatic mode (→ page 133)
- ⑤  Defrosts the windshield
- ⑥  Switches the rear window defroster on/off
- ⑦  Switches air-recirculation mode on/off (→ page 134)

- ⑧  Switches the A/C function on/off (→ page 133)  
Switches the residual heat on/off (→ page 134)
  - ⑨ **SYNC** Activates or deactivates synchronization (→ page 134)
  - ⑩  Sets the temperature on the front passenger side
- i** Residual heat can be used only for vehicles with a diesel engine or with a stationary heater in conjunction with the THERMOTRONIC air conditioning control panel.

### Operating the climate control system



#### Switching climate control on/off

- ▶ **To switch on:** set the airflow to level 1 or higher using the  button.
- ▶ **To switch off:** set the airflow to level 0 using the  button.

If climate control is switched off, the windows may fog up more quickly. Switch climate control off only briefly.

### Switching the A/C function on/off using the air conditioning control panel

The A/C function heats, cools and dehumidifies the vehicle's interior air.

▶ Press the  /  button.

Switch off the A/C function only briefly; otherwise, the windows may fog up more quickly.

Condensation may drip from the underside of the vehicle when cooling mode is active. This is not indicative of a malfunction.

### Activating/deactivating the A/C function via the air conditioning menu

Multimedia system:

↳ Climate Menu ▶▶ First Row of Seats

Depending on the external conditions, support for improved cooling and dehumidification of the inte-



rior air will be provided when the A/C function is activated. If it is not possible to operate the A/C function on the climate bar on the central display, switch the function on or off in the climate menu of the central display.

▶ Select A/C (A/C).

### Setting climate control to automatic

In automatic mode, the set temperature is controlled and maintained at a constant level by the air supply.

▶ Press button .

▶ **To switch to manual mode:** press the  or  button.

In automatic mode, you can choose between five different air quantities using the  button. Automatic mode is retained.

### Setting air distribution via the air conditioning menu

Multimedia system:

↳ Climate Menu

▶ Select **First Row of Seats** or **Second Row of Seats**.

▶ To set air distribution: select ,  or .

▶ Set the airflow.

ⓘ When the air conditioning system is switched on, at least one zone is always active. However, several air distribution options can be selected at the same time, for example to set the climate control for the vehicle interior and the footwells simultaneously. The  climate control for the windshield can only be selected for the first seat row. When automatic mode is active, the buttons for setting the air distribution are deactivated automatically. If the air conditioning system is deactivated, the buttons remain operable and the last setting is saved.

### Switching the synchronization function on/off via the air conditioning control panel

#### Requirements

- The vehicle is not fitted with a stationary heater.

Climate control can be set centrally using the synchronization function. The temperature and air distribution settings for the driver's side will be adopted automatically for the front passenger side.

- ▶ Press the **SYNC** button.

The synchronization function will be deactivated if the settings for one of the other climate zones are changed.

### Switching the synchronization function on/off via the air conditioning menu

Multimedia system:

- ➔ Climate Menu ➔ First Row of Seats

The synchronization function controls the climate control centrally. The driver's settings for temper-

ature, airflow and air distribution are automatically adopted for each climate zone.

- ▶ Select **SYNC** (SYNC).

### Defrosting the windows

#### Windows fogged up on the inside

- ▶ Press the **AUTO** button.
- ▶ If the windows remain fogged up: press the **MAX** button.

#### Windows fogged up on the outside

- ▶ Switch on the windshield wipers.
- ▶ Press the **AUTO** button.

### Switching air-recirculation mode on/off

- ▶ Press the **RECIRC** button.  
The interior air will be recirculated.

Air-recirculation mode automatically switches to fresh air mode after a while.

- ⓘ If air-recirculation mode is switched on, the windows may fog up more quickly. Switch on air-recirculation mode only briefly.

### Switching the residual heat on/off (Canada)

#### Requirements

- The vehicle is parked.
- ⓘ Only vehicles with a diesel engine can use residual heat.

It is possible to make use of the residual heat from the engine to continue heating or ventilating the front compartment of the vehicle for approximately 30 minutes, depending on the temperature set.

- ▶ **To activate:** press the **A/C RES** button.

Residual heat will be switched off automatically.



## Air vents

### Adjusting the front air vents

**⚠ WARNING** Risk of burns or frostbite due to being too close to the air vents

Very hot or very cold air can flow from the air vents.

- ▶ Make sure that all vehicle occupants always maintain a sufficient distance from the air vents.
- ▶ If necessary, direct the airflow to another area of the vehicle interior.

To guarantee the flow of fresh air through the air vents into the vehicle interior, note the following:

- Always keep the vents and ventilation grilles in the vehicle interior clear.
- Keep the air inlet free of residue build-up (→ page 281).

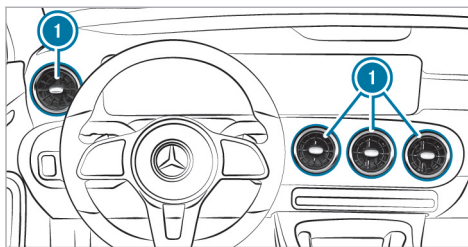

- ▶ **To open or close:** hold the center of air vent ① and turn it to the left (open) or right (closed) as far as it will go.
- ▶ **To set the airflow direction:** hold the center of air vent ① and move it up or down or to the left or right.

### Adjusting the rear air vents

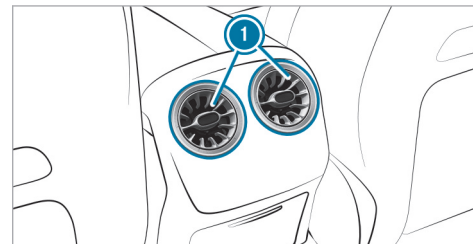

- ▶ **To open or close:** hold the center of air vent ① and turn it to the left or right as far as it will go.
- ▶ **To set the airflow direction:** hold the center of air vent ① and move it up or down or to the left or right.

## Driving

### Notes on Mercedes-AMG vehicles

Observe the notes on the following additional topics in the Supplement, as you may otherwise fail to recognize dangers:

- Reduction of engine output and engine torque
- AMG Real Performance Sound
- RACE START
- DRIFT MODE
- AMG RIDE CONTROL
- AMG steering-wheel buttons

### Switching on the power supply or the vehicle

**⚠ WARNING** Risk of accident and injury due to children left unattended in the vehicle

If you leave children unattended in the vehicle, they could, in particular:

- open doors, thereby endangering other persons or road users.
- get out and be struck by oncoming traffic.
- operate vehicle equipment and become trapped, for example.

In addition, the children could also set the vehicle in motion by, for example:

- releasing the parking brake.
- changing the gearbox position.
- starting the vehicle.

- ▶ Never leave children unattended in the vehicle.
- ▶ When leaving the vehicle, always take the key with you and lock the vehicle.
- ▶ Keep the key out of reach of children.

### Requirements

- The key is in the vehicle and is recognized.
- The brake pedal is not depressed.

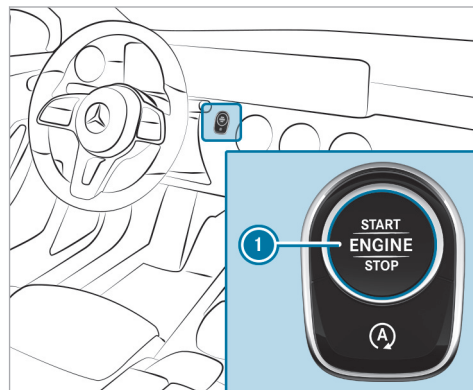

- ▶ **To switch on the power supply:** press button ① once.  
You can, for example, switch on the windshield wipers.

The power supply will be switched off again if the following conditions are met:

- You open the driver's door.
- You press button ❶ twice more.

▶ **To switch on the vehicle:** press button ❶ twice.  
Indicator and warning lamps will light up on the driver's display.

The vehicle will be switched off again if one of the following conditions is met:

- You do not start the vehicle within 15 minutes and the transmission is in position **P** or the electric parking brake is applied.
- You press button ❶ once.

## Starting the vehicle

### Starting the vehicle with the start/stop button

**⚠ DANGER** Risk of death caused by exhaust gases

Combustion engines emit poisonous exhaust gases such as carbon monoxide. Inhaling these exhaust gases is hazardous to health and leads to poisoning.

- ▶ Never leave the engine or, if present, the auxiliary heating running in an enclosed space without sufficient ventilation.

**⚠ WARNING** Risk of fire due to flammable materials in the engine compartment or on the exhaust system

Flammable materials may ignite.

- ▶ Therefore, regularly check that there are no flammable foreign materials in the engine compartment or on the exhaust system.

### Requirements

- The key is in the vehicle and is recognized.
- ▶ Shift the transmission to position **P** or **N**.
- ▶ Depress the brake pedal and press button ❶ once.
- ▶ Keep the brake pedal depressed until the vehicle has started.
- ▶ If the vehicle does not start: switch off non-essential electrical consumers and press button ❶ once.
- ▶ If the vehicle still does not start and a display message also appears in the driver's display **Place the Key in the Marked Space** See **Operator's Manual**: start the vehicle with the key in the marked space (emergency operation) (→ page 138).
- ❶ You can switch off the vehicle while driving. To do this, press and hold button ❶ for about three seconds or press button ❶ three times within three seconds. Be sure to observe the safety notes concerning this under "Driving tips" (→ page 140).

Observe the information regarding messages that may appear in the driver's display.

**Starting the vehicle with the key in the marked space (emergency operation mode)**

If the vehicle does not start and the **Place the Key in the Marked Space See Operator's Manual** message appears on the driver's display, you can start the vehicle in emergency mode.

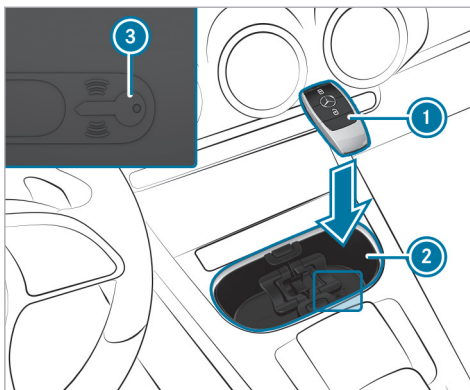

Marked space (example with cup holder without cover)

- ▶ Open the cover of marked space ② if necessary.
- ▶ Make sure that marked space ② is empty.
- ▶ Remove key ① from the key ring.

- ▶ Place key ① on symbol ③ in marked space ②.  
The vehicle will start after a short time.  
If you remove key ① from marked space ②, the vehicle can still be driven. For further engine starts, however, key ① must be located on symbol ③ in marked space ② during the entire journey.
- ▶ Have key ① checked at a qualified specialist workshop.

**If the vehicle does not start:**

- ▶ Place key ① in marked space ② and leave it there.
- ▶ Depress the brake pedal and start the vehicle using the start/stop button.
- ▶ Keep the brake pedal depressed until the vehicle has started.
- ⓘ You can switch on the power supply or the vehicle with the start/stop button.

Observe any information regarding display messages that may be shown on the driver's display.

## Starting the vehicle via Remote Online Services

### Cooling or heating the vehicle interior before starting the journey

Ensure the following before starting the engine:

- The legal stipulations in the area where your vehicle is parked allow engine starting via smartphone.
- It is safe to start and run the engine where your vehicle is parked.
- The fuel tank is sufficiently full.
- The starter battery is sufficiently charged.

### Charging the starter battery before starting the journey

You can receive a message on your smartphone when the state of charge of the starter battery is low. You can then start the vehicle with the smartphone to charge the battery. The vehicle is automatically switched off after ten minutes.

Ensure the following before starting the engine:

- The legal stipulations in the area where your vehicle is parked allow engine starting via smartphone.

- It is safe to start and run the engine where your vehicle is parked.
- The fuel tank is sufficiently full.

### Starting the vehicle (Remote Online)

**⚠ WARNING** Risk of crushing or entrapment due to unintentional starting of the engine

Limbs could be crushed or trapped if the engine is started unintentionally during service or maintenance work.

- ▶ Always secure the engine against unintentional starting before carrying out maintenance or repair work.



### Requirements

- park position **P** is selected.
- the anti-theft alarm system is not activated.
- the panic alarm is not activated.
- the hazard warning light system is switched off.
- the hood is closed.
- the doors are closed and locked.

- the windows and sliding sunroof are closed.
- ▶ Start the vehicle using the smartphone. After every vehicle start, the engine runs for ten minutes.

You can carry out a maximum of two consecutive starting attempts. You must start the vehicle with the key before trying to start the vehicle again with the smartphone.

You can switch off the vehicle at any time as follows:

- Via the smartphone app
- By pressing the  or  button on the key
- ⓘ Further information can be found in the smartphone app.

### Securing the engine against starting before carrying out maintenance or repair work:

- ▶ Switch on the hazard warning light system or unlock the doors.
- ▶ Open a side window or the sliding sunroof.

### Notes on breaking-in a new vehicle

To preserve the engine during the first 1000 miles (1500 km):

- Drive at varying road speeds and engine speeds.
- No faster than 85 mph (140 km/h).
- Drive the vehicle in drive mode **C** or **E**.
- Shift to the next higher gear at the very latest when the needle reaches the last third before the red area in the tachometer.
- Do not shift down manually in order to brake.
- Avoid overstraining the vehicle, e.g. driving at full throttle.
- Do not depress the accelerator pedal past the pressure point (kickdown).
- Only increase the engine speed gradually and accelerate the vehicle to full speed after 1000 miles (1500 km).

This also applies when the engine or parts of the drivetrain have been replaced.

Please also observe the following breaking-in notes:

- In certain handling and driving safety systems, the sensors adjust automatically while a certain distance is being driven after the vehicle has been delivered or after repairs. Full system effectiveness is only reached when this teaching-in process has concluded.
- Brake pads, brake disks and tires that are either new or have been replaced achieve optimum braking effect and grip only after the vehicle has been driven several hundred kilometers. Compensate the reduced braking effect by applying greater force to the brake pedal.

### Notes on driving

**⚠ WARNING** Risk of accident due to objects in the driver's footwell

Objects in the driver's footwell may impede pedal travel or block a depressed pedal.

This will jeopardize the operating- and road safety of the vehicle.

- ▶ Stow all objects in the vehicle securely so that they cannot get into the driver's footwell.
- ▶ Make sure that there is always sufficient clearance for the pedals.
- ▶ Always install the floor mats securely and as prescribed.
- ▶ Do not use loose floor mats and do not place floor mats on top of one another.

**⚠ WARNING** Risk of accident due to incorrect footwear

Incorrect footwear includes, for example:

- Shoes with platform soles
- Shoes with high heels
- Slippers

There is a risk of an accident.

- ▶ Always wear suitable footwear so that you can operate the pedals safely.

**⚠ WARNING** Risk of accident if the vehicle is switched off while driving

If you switch off the vehicle while driving, safety functions are restricted or no longer available.

This may affect the power steering system and the brake force boosting, for example.

You will need to use considerably more force to steer and brake, for example.

- ▶ Do not switch off the vehicle while driving.

**⚠ DANGER** Risk of death caused by exhaust gases

Combustion engines emit poisonous exhaust gases such as carbon monoxide. Inhaling these exhaust gases is hazardous to health and leads to poisoning.

- ▶ Never leave the engine or, if present, the auxiliary heating running in an enclosed space without sufficient ventilation.

**⚠ WARNING** Risk of skidding and of an accident due to shifting down on slippery road surfaces

If you shift down on slippery road surfaces to increase the engine braking effect, the drive wheels may lose traction.

- ▶ Do not shift down on slippery road surfaces to increase the engine braking effect.

**⚠ DANGER** Risk of fatal injury due to poisonous exhaust gases

If the tailpipe is blocked or sufficient ventilation is not possible, poisonous exhaust gases such as carbon monoxide may enter the vehicle. This is the case, for example, if the vehicle gets stuck in the snow.

- ▶ Keep the tailpipe and the area around the vehicle free from snow when the engine or the stationary heater is running.

- ▶ Open a window on the side of the vehicle facing away from the wind to ensure an adequate supply of fresh air.

**⚠ WARNING** Risk of accident and injury due to being under the influence of alcohol and drugs while driving

Drinking and driving and/or taking drugs and driving are very dangerous combinations. Even a small amount of alcohol or drugs can affect your reflexes, perceptions and judgment.

The possibility of a serious or even fatal accident are greatly increased when you drink or take drugs and drive.

- ▶ Do not drink or take drugs and drive or allow anyone to drive who has been drinking or taking drugs.

**⚠ WARNING** Risk of accident due to the brake system overheating

If you leave your foot on the brake pedal when driving, the brake system may overheat.

This increases the braking distance and the brake system can even fail.

- ▶ Never use the brake pedal as a footrest.
- ▶ Do not depress the brake pedal and the accelerator pedal at the same time while driving.

**!** **NOTE** Engine damage due to excessively high engine speeds

The engine will be damaged if you drive with the engine in the overrevving range.

- ▶ Do not drive with the engine in the overrevving range.

**!** **NOTE** Wearing out the brake linings by continuously depressing the brake pedal

- ▶ Do not depress the brake pedal continuously whilst driving.
- ▶ To use the braking effect of the engine, shift to a lower gear in good time.

**!** **NOTE** Damage to the drivetrain and engine when pulling away

- ▶ Do not warm up the engine while the vehicle is stationary. Pull away immediately.
- ▶ Avoid high engine speeds and driving at full throttle until the engine has reached its operating temperature.

**!** **NOTE** Damage to the catalytic converter due to non-combusted fuel

The engine is not running smoothly and is misfiring.

Non-combusted fuel may get into the catalytic converter.

- ▶ Only depress the accelerator pedal slightly.
- ▶ Have the cause rectified immediately at a qualified specialist workshop.

**!** **NOTE** Reduced battery life due to frequent short-distance trips

The 12 V battery may not be sufficiently charged when the vehicle is used only for short-distance trips. This reduces the life of the battery.

- ▶ Drive longer distances regularly to charge the battery.

**!** **NOTE** Vehicle damage due to failure to observe the maximum permissible clearance height

If the vehicle height exceeds the maximum permissible clearance height, the roof and other vehicle parts may be damaged.

- ▶ Please observe the maximum clearance height indicated.
- ▶ If the vehicle exceeds the permissible clearance height, do not drive in.
- ▶ Take the modified vehicle height into account in the case of roof superstructures or other carrier systems.



- ⓘ Bear in mind that all the speed values stated in this Operator's Manual are approximate and are subject to a certain tolerance.

#### Notes on driving with a roof load, trailer or fully laden vehicle

When driving with a loaded roof luggage rack or trailer as well as with a fully laden or fully occupied vehicle, your vehicle's driving and steering characteristics will change.

You should therefore bear the following in mind:

- Do not exceed the permissible roof load and towing capacity. Also observe the information in the Technical Data.
- Distribute the roof load and the load inside the vehicle evenly, placing heavy objects at the bottom. Also comply with the notes on loading the vehicle (→ page 107).
- Drive attentively and avoid abrupt starts, braking and steering as well as rapid cornering.

#### Advice on driving on salt-strewn roads

The braking effect is limited on salt-strewn road surfaces.

Therefore, observe the following notes:

- Salt build-up on the brake disks and brake pads may cause the braking distance to increase considerably or result in one-sided braking.
- Maintain a much greater safety distance to the vehicle in front.

Eliminate salt build-up as follows:

- Brake occasionally, paying attention to the traffic conditions
- Carefully depress the brake pedal at the end of the journey and when starting the next journey

#### Notes on hydroplaning

Hydroplaning can take place if a certain depth of water has built up on the road surface.

Observe the following notes during heavy precipitation or in conditions in which hydroplaning may occur:

- Reduce your speed
- Avoid tire ruts

- Avoid sudden steering movements
- Brake carefully

- ⓘ Also observe the notes on regularly checking wheels and tires (→ page 314).

#### Notes on driving through water on the road

Water ingress can damage the engine, electrics and transmission.

Water can also enter the air intake of the engine and cause engine damage.

Observe the following notes if you have to drive through water:

- The water, when calm, may reach no higher than the lower edge of the vehicle body.
- Drive at walking pace at most; water may otherwise enter the vehicle interior or engine compartment.
- Vehicles in front or oncoming vehicles can create waves which may exceed the maximum permissible depth of water.

The braking effect of the brakes is reduced after you have driven through water. Brake carefully,

paying attention to the traffic conditions, until braking effect has been fully restored.

### ECO start/stop function

#### ECO start/stop function

- ① Depending on the engine, the ECO start/stop function is not available in all drive programs. Observe the status display in the driver's display for this.

The engine will be switched off automatically in the following situations if all vehicle conditions for an automatic engine stop are met:

- You brake the vehicle to a standstill in transmission position **D** or **N**.
- Vehicles with a 48 V on-board electrical system:** you depress the brake pedal when traveling at a low speed.

If the system has detected one of the following situations, the engine will not stop:

- You stop at a stop sign and there is no vehicle in front of you.

- The vehicle that stopped in front of you sets off again.
- You maneuver, turn the steering wheel sharply or engage reverse gear.





- ① If the system detects an intelligent stop inhibitor, e.g. a stop sign, the engine will not stop. If you activate the HOLD function or engage park position **P**, the engine can be switched off in spite of an intelligent stop inhibitor.

The engine will restart automatically in the following cases:

- You engage transmission position **D** or **R**.
- You depress the accelerator pedal.
- The vehicle requires an automatic engine start.
- You release the brake pedal.
- Vehicles with a 48 V on-board electrical system:**
  - You release the brake pedal on a downhill gradient and the vehicle does not roll.

- The vehicle rolls on a downhill gradient and does not automatically enter glide mode at 15 mph (20 km/h).

ECO start/stop function symbols on the driver's display:

- The  symbol (green) appears when the vehicle is at a standstill: the engine was switched off by the ECO start/stop function.
- The  symbol (yellow) appears when the vehicle is at a standstill: not all vehicle conditions for an engine stop have been met.
- Neither the  symbol nor the  symbol appears when the vehicle is at a standstill: an intelligent stop inhibitor, e.g. a stop sign, has been detected.
- The  symbol appears: the ECO start/stop function is deactivated or there is a malfunction.

If the engine was switched off by the ECO start/stop function and you leave the vehicle, a warning tone will sound and the engine will not be restarted. In addition, the following display message will appear on the driver's display:

### Vehicle is Ready to Drive Switch Off Vehicle Before Exiting

If you do not switch off the vehicle, it will automatically be switched off after three minutes.

### Switching the ECO start/stop function on/off

#### **!** NOTE Mercedes-AMG vehicles

- ▶ Observe the notes in the Supplement. You could otherwise fail to recognize dangers.

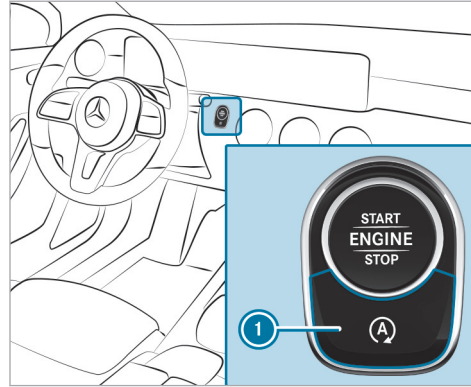

- ▶ Press button ①.  
A display will appear on the driver's display when you switch the ECO start/stop function on/off.
- ①  will be continuously shown on the driver's display while the ECO start/stop function is deactivated.

### ECO display function

- ① Depending on the model and equipment, your vehicle has one of the following representations of the ECO display.

The ECO display summarizes your driving characteristics from the start of the journey to its completion and assists you in achieving the most economical driving style.

The ECO display assesses the following criteria for an economical driving style:

- coasting at the right times
- consistent speed
- moderate acceleration

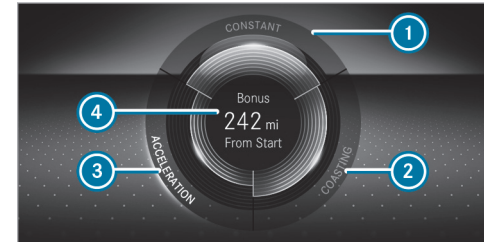

The lettering in the segment will light up brightly, the outer edge will light up and the segment will fill up when the following driving style is adopted:

- ① Steady speed
- ② Gentle deceleration and rolling
- ③ Moderate acceleration

The lettering in the segment will be gray, the outer edge will be dark and the segment will empty when the following driving style is adopted:

- ① Fluctuations in speed
- ② Heavy braking
- ③ Sporty acceleration

The ECO display will show you when you have driven economically:

- The three segments will fill up completely at the same time
- The edges around all three segments will light up

The additional range achieved as a result of your driving style in comparison with a driver with a

very sporty driving style will be shown in the center of display ④. The range displayed does not indicate a fixed reduction in consumption.

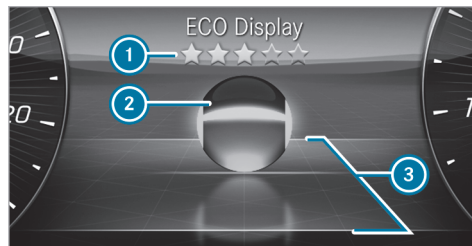

The ECO display shows an evaluation of your driving style on the driver's display depending on the situation. This enables you to check the efficiency of your driving style and adjust it if necessary. The **ECO Display** menu shows ball ② that will roll forwards or backwards on a stylized road in the direction of travel according to the driving characteristics.

Above and below the road, lines mark the area for an efficient driving style ③. Ball ② will light up in

green if it is rolling within these lines. Outside the lines, the ball will light up in orange.

The overall assessment of your driving style "from start" is indicated using stars ①. It starts with five empty stars, which you can fill one after the other if you drive efficiently. When all five stars are filled, a glow will appear in the background.

④ You can call up the **ECO Display** function via the **Classic** menu (→ page 221).

### **ECO Assist function (vehicles with 48 V on-board electrical system)**

④ ECO Assist is active only in drive programs **E** and **C**.

ECO Assist analyzes data for the vehicle's expected route. This allows the system to optimally adjust the driving style for the route ahead, save fuel and recuperate. If the system detects an event ahead and the vehicle nears the event, ECO Assist will calculate the optimum speed for maximum fuel economy and recuperative energy based on the distance, speed and downhill gradient.

If the deceleration provided by ECO Assist is not sufficient, you must also brake with the service brake. This is especially the case if, for example, you pull away again in slow-moving traffic and the distance to the vehicle in front is very short.

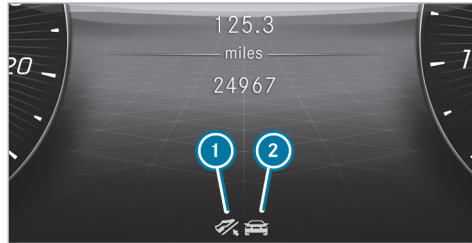

- ① "Foot off the accelerator" recommendation
- ② Route event ahead



If a route event ahead or a vehicle driving in front is detected which requires an adjustment to your driving style to ensure greater efficiency, corresponding symbol ② and the  symbol will be displayed in gray.

If you release the accelerator pedal, the  symbol will turn green and recuperation in over-run mode will be initiated. If the deceleration is not sufficient, also apply the service brake. If ECO Assist intervenes for a route event ahead (not for a vehicle in front) and you then press the accelerator pedal again, you end ECO Assist's control.



The ECO Assist display is hidden again in the following cases:

- You do not react to the ECO Assist recommendation for a long time.
- You press the accelerator pedal while ECO Assist is intervening for a route event ahead (not for a vehicle in front).
- ECO Assist cannot identify any further recommendations from the route ahead.

Depending on the equipment, in addition to the  vehicle driving ahead, ECO Assist detects following route events ②:

-  Traffic circle
-  T-intersection
-  Downhill gradient

 Speed limit

- ① In the  drive program, ECO Assist only reacts to the route event "Vehicle in front" without a display of the  route event and the  recommendation.

### System limits

If the calculated route is adhered to when route guidance is active, ECO Assist will operate with greater accuracy. The basic function is also available without active route guidance. Not all information and traffic situations can be foreseen. The quality depends on the map data.

ECO Assist is only an aid. The driver is responsible for keeping a safe distance from the vehicle in front, for vehicle speed and for braking in good time.

The system may be impaired or may not function in the following situations:

- If there is poor visibility, e.g. due to insufficient illumination of the road, highly variable shade conditions, rain, snow, fog or heavy spray.
- If there is glare, e.g. from oncoming traffic, direct sunlight or reflections.

- If the windshield is dirty in the vicinity of the multifunction camera.
- If the multifunction camera is fogged up, damaged or obscured.
- If road signs are hard to detect, e.g. due to dirt, snow or insufficient lighting, or because they are obscured.
- If the information in the navigation system's digital map is incorrect or out of date.
- If signs are ambiguous, e.g. road signs in roadworks or in adjacent lanes.
- If the radar sensors are dirty or obscured.
- When you drive on roads with steep uphill or downhill gradients.
- If there are narrow vehicles in front, such as bicycles or motorcycles.

## DYNAMIC SELECT

### Function of DYNAMIC SELECT

#### **!** NOTE Mercedes-AMG vehicles

- ▶ Observe the notes in the Supplement. You could otherwise fail to recognize dangers.

DYNAMIC SELECT makes the quick selection of a drive program possible in accordance with the current driving situation or the desired vehicle characteristics. You can select from the following drive programs.

- i** Depending on the engine and equipment, the vehicle has different drive programs.

The drive program selected appears in the driver's display.

#### **I\*** Individual

- Individual settings (→ page 149)

#### **S** Sport

- The maximum drive output is available
- Sporty driving

- Sporty, but with an emphasis on stability
- Enables a sporty driver to adopt a more active driving style
- Only suitable for good road conditions, a dry road surface and a clear stretch of road

#### **C** Comfort

- Comfortable and economical driving
- Balance between traction and stability
- Recommended for all road conditions

#### **E** Eco

- Particularly economical driving
- Balance between traction and stability
- Recommended for all road conditions

- i** The ESP® settings in drive programs **E** and **C** are designed for stability. Therefore, choose one of these drive programs especially when transporting roof loads, in trailer operation and when the vehicle is fully loaded or fully occupied.

Depending on the drive program, the following systems will change their characteristics:

- Drive
  - engine and transmission management
  - Active Distance Assist DISTRONIC
  - availability of Glide mode
- ESP®
- **Vehicles with adaptive damping adjustment:** suspension
- Steering

### Selecting the drive program

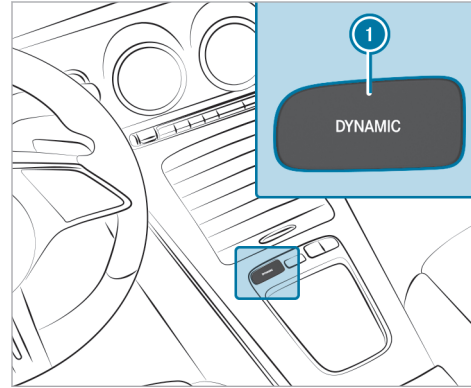

- ▶ Press DYNAMIC SELECT button ❶ as many times as necessary until the selected drive program is displayed in the driver's display.
- or
- ▶ Press DYNAMIC SELECT button ❶ and select the drive program in the DYNAMIC SELECT menu on the central display.

### Configuring DYNAMIC SELECT in the multimedia system

Multimedia system:

- ▶ ▶ Settings ▶ Vehicle
- ▶ ▶ DYNAMIC SELECT

#### Setting drive program I

- ▶ Select Individual.
  - ▶ Select and set a category.
- ❶ A sporty ESP mode can be set in conjunction with a sporty suspension mode.

#### Switching the reset display on/off

- ▶ Switch Request at Start on or off.
- ❶ This function must be activated for each user profile separately. Only when this function is activated will the drive program and ECO start/stop setting for the previous journey be saved for the respective user profile.

**Function on:** the next time the vehicle is started a prompt appears asking whether the last active drive program should be restored. If the ECO start/stop function was deactivated, an additional

prompt appears asking if the function should remain deactivated.

- ① The prompt appears only if the previously active settings deviate from the standard settings.

**Function off:** the next time the vehicle is started the **[C]** drive program is set automatically. The ECO start/stop function is activated automatically.

### Displaying vehicle data

Multimedia system:



- ▶ Select **Vehicle**.  
The vehicle data is displayed.

### Displaying engine data

Multimedia system:





- ▶ Select **Engine**.  
The engine data is displayed.

- ① The actual maximum values that can be achieved for engine output and engine torque may deviate from the certified values within the country-specific guidelines for permissible tolerances (basis: UN-ECE No. 85 or country-specific guidelines).

Variables that can influence this are, for example:

- Sea level
- Fuel quality
- Outside temperature
- Operating temperature of the engine

Adjust your driving style accordingly. The  warning lamp in the driver's display is on until the engine has reached operating temperature.

- ① The values displayed serve only as orientation. The values for engine output and engine torque shown in the media display may deviate from the actual values.
- ① The  warning lamp to show the power output limitation after starting the vehicle is not available in all vehicle models.

### Calling up the fuel consumption indicator

Multimedia system:



- ▶ Select **Consumption**.  
The current and average fuel consumption will be displayed.

### Automatic transmission

#### DIRECT SELECT lever

#### Function of the DIRECT SELECT lever

**⚠ WARNING** Risk of accident due to incorrect gearshifting

If the engine speed is higher than the idle speed and you engage the transmission position **[D]** or **[R]**, the vehicle may accelerate sharply.

- ▶ If you engage the transmission position **[D]** or **[R]** when the vehicle is at a standstill, always depress the brake pedal



firmly and do not accelerate at the same time.

**⚠ WARNING** Risk of accident and injury due to children left unattended in the vehicle

If you leave children unattended in the vehicle, they could, in particular:

- open doors, thereby endangering other persons or road users.
- get out and be struck by oncoming traffic.
- operate vehicle equipment and become trapped, for example.

In addition, the children could also set the vehicle in motion by, for example:

- releasing the parking brake.
- changing the gearbox position.
- starting the vehicle.

▶ Never leave children unattended in the vehicle.

- ▶ When leaving the vehicle, always take the key with you and lock the vehicle.
- ▶ Keep the key out of reach of children.

Use the DIRECT SELECT lever to switch the transmission position. The current transmission position will be shown on the driver's display.

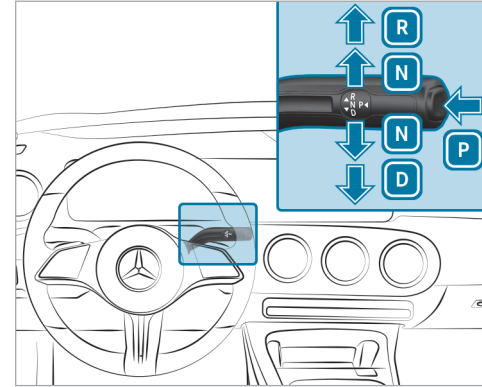

- P** Park position
- R** Reverse gear
- N** Neutral
- D** Drive position

**Engaging reverse gear R**

- ▶ Depress the brake pedal and push the DIRECT SELECT lever upwards past the first point of resistance.

### Engaging neutral N

▶ Depress the brake pedal and push the DIRECT SELECT lever up or down to the first point of resistance.

- ⓘ To shift into neutral **N** with the vehicle switched on, push the selector lever up or down for several seconds to the first point of resistance.

Subsequently releasing the brake pedal will allow you to move the vehicle freely, e.g. to push it or tow it away.

**Proceed as follows if you want the automatic transmission to remain in neutral **N**, even if the vehicle is switched off or the driver's door is opened:**

- ▶ Depress the brake pedal and engage neutral **N** when the vehicle is at a standstill.
- ▶ Release the brake pedal.
- ▶ Switch off the vehicle.

The **Risk of Vehicle Rolling Away N Activated Manually No Automatic Change to P** message appears in the driver's display.

- ⓘ If you then exit the vehicle leaving the key in the vehicle, the automatic transmission remains in neutral **N**.

The park position **P** is automatically re-engaged as soon as one of the following conditions is met:

- You switch to transmission position **D** or **R**.
- You press the button **P**.

### Engaging park position P

**!** **NOTE** Damage due to engaging park position **P** while the vehicle is rolling

If you shift the transmission into park position **P** while the vehicle is rolling, the transmission may be damaged.

- ▶ If the vehicle is rolling, do not open a door.
- ▶ Only engage park position **P** when the vehicle is stationary.

- ▶ Observe the notes on parking the vehicle (→ page 158).

▶ Depress the brake pedal until the vehicle comes to a standstill.

▶ When the vehicle is stationary, press button **P**.

When the transmission position display shows **P**, the park position is engaged. If the transmission position display **P** is not shown, apply the parking brake and secure the vehicle to prevent it from rolling away.

- ⓘ Depending on the situation, it may take a short time until **P** is engaged. Therefore, always pay attention to the transmission position display.

Park position **P** will be engaged automatically if one of the following conditions is met:

- You switch the stationary vehicle off in transmission position **D** or **R**.
- You open the driver's door when the vehicle is stationary in transmission position **D** or **R**.
- When the vehicle is rolling, you switch if off in transmission position **D** or **R** and bring it to a standstill.

- When the vehicle is rolling, you shift to transmission position **N**, bring the vehicle to a standstill and open the driver's door when the vehicle is stationary.
  - Engaging park position **P** automatically is required by the vehicle.
- i** To maneuver with an open driver's door, open the driver's door while the vehicle is stationary and engage transmission position **D** or **R** again.
- i** At very low outside temperatures below approximately  $-4^{\circ}\text{F}$  ( $-20^{\circ}\text{C}$ ), it may not be possible to shift the transmission from **P** to another transmission position when the vehicle is switched off. If this is the case, change the transmission position only while the vehicle is switched on.

#### **Engaging drive position D**

- ▶ Depress the brake pedal and push the DIRECT SELECT lever down past the first point of resistance.

When the automatic transmission is in transmission position **D**, it will shift gears automatically. This depends, among other things, on the following factors:

- The selected drive program
- The position of the accelerator pedal
- The driving speed

#### **Problems with the transmission**

##### **The transmission has a faulty gear shift**

Possible cause:

- the transmission is losing oil.

- ▶ Have the transmission checked at a qualified specialist workshop immediately.

##### **The acceleration characteristics worsen, and the transmission no longer shifts.**

Possible cause:

- the transmission is in emergency operation mode.

- ▶ Pull over and stop the vehicle safely as soon as possible, paying attention to road and traffic conditions.
- ▶ Shift the transmission to position **P**.
- ▶ Switch off the vehicle.
- ▶ Wait at least ten seconds.
- ▶ Start the vehicle again.
- ▶ Shift the transmission to position **D**.
- ▶ Have the transmission checked at a qualified specialist workshop immediately.

#### **Manual gearshifting**

**i** **NOTE** Mercedes-AMG vehicles

- ▶ Observe the notes in the Supplement. You could otherwise fail to recognize dangers.

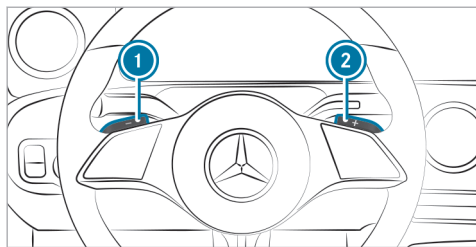

When the automatic transmission is shifted to position **D**, you can manually shift it with the steering wheel paddle shifter. If permitted, the automatic transmission will shift to a higher or lower gear depending on which steering wheel paddle shifter is pulled.

You have two options for manually shifting the automatic transmission:

- temporary setting
- permanent setting

The gears will shift automatically when manual shifting is deactivated.

#### Temporary setting:

- ▶ **To activate:** pull steering wheel paddle shifter **1** or **2**. Manual shifting will be activated for a short time. The transmission position display will show **M** and the current gear.

- ⓘ How long manual shifting stays activated depends on various factors.

Manual shifting can be deactivated automatically in the following cases:

- When the drive program is changed
- When the vehicle is restarted
- When transmission position **D** is engaged again
- Driving style

- ▶ **To shift up:** pull steering wheel paddle shifter **2**.

- ▶ **To shift down:** pull steering wheel paddle shifter **1**. If you pull and hold steering wheel paddle shifter **1**, the transmission will shift to the lowest possible gear.

- ▶ **To deactivate:** pull steering wheel paddle shifter **2** and hold it in place. The transmission position display will show **D**.

- ⓘ You can also activate or deactivate manual shifting permanently in the multimedia system.

#### Permanently activating or deactivating manual gearshifting

Multimedia system:

→ ▶ Settings ▶ Vehicle ▶ Driving

- ▶ Permanently switch the function on or off.

#### Gearshift recommendation

The gearshift recommendation assists you in adopting an economical driving style.

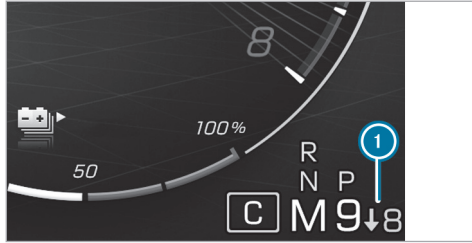

- ▶ If gearshift recommendation ① appears next to the transmission position display, shift to the recommended gear.

### Using kickdown

- ▶ **Maximum acceleration:** depress the accelerator pedal beyond the point of resistance.

To protect against engine overrev, the automatic transmission will shift up to the next gear when maximum engine speed has been reached.

### Glide mode function

#### ! NOTE Mercedes-AMG vehicles

- ▶ Observe the notes in the Supplement. You could otherwise fail to recognize dangers.

With an anticipatory driving style, Glide mode helps you to reduce fuel consumption.

Glide mode is characterized by the following:

- The combustion engine is disconnected from the drivetrain and continues to idle in neutral.
- Transmission position display **D** is shown in green.
- **Vehicles with 48 V on-board electrical system:** the combustion engine is switched off depending on the driving situation. All of the vehicle functions remain active.

Glide mode is activated if the following conditions are met:

- Drive program **E** is selected.
- The speed is within a suitable range.

- The road's course is suitable, e.g. no steep uphill or downhill inclines or tight bends.
- The state of charge of the battery is sufficient.
- You do not depress the accelerator or brake pedal (except for light brake applications).
- ① Glide mode can also be activated if you have selected the "Eco" setting for the drive system in drive program **I**.

Glide mode is deactivated again if one of the conditions is no longer met.

**Vehicles with Active Distance Assist DISTRONIC:** when Active Distance Assist DISTRONIC is active, the glide mode function is not available.

Glide mode can also be prevented by the following parameters:

- Incline
- Downhill gradient
- Temperature
- Height
- Speed
- Operating condition of the engine

- Road and traffic conditions
- i** You can end Glide mode by operating a steering wheel paddle shifter (→ page 153).

### Function of the 4MATIC

4MATIC ensures that all four wheels are driven. Together with ESP® and 4ETS, 4MATIC improves the traction of your vehicle whenever a driven wheel spins due to insufficient traction.

If you fail to adapt your driving style, 4MATIC can neither reduce the risk of an accident nor override the laws of physics. 4MATIC cannot take account of road, weather and traffic conditions. 4MATIC is only an aid. You are responsible especially for maintaining a safe distance from the vehicle in front, for vehicle speed, for braking in good time and for staying in lane.

- i** In wintry driving conditions, the maximum effect of 4MATIC can only be achieved if you use winter tires (M+S tires), with snow chains if necessary.

### Refueling

#### Refueling the vehicle

**⚠ WARNING** Risk of fire or explosion from fuel

Fuels are highly flammable.

- ▶ Fire, open flames, smoking and creating sparks must be avoided.
- ▶ Before refueling, switch off the vehicle and, if installed, the stationary heater, and leave them switched off during refueling.

**⚠ WARNING** Risk of injury from fuels

Fuels are poisonous and hazardous to your health.

- ▶ Do not swallow fuel or let it come into contact with skin, eyes or clothing.
- ▶ Do not inhale fuel vapor.
- ▶ Keep children away from fuel.

- ▶ Keep doors and windows closed during the refueling process.

If you or other people come into contact with fuel, observe the following:

- ▶ Immediately rinse fuel off your skin with soap and water.
- ▶ If fuel comes into contact with your eyes, immediately rinse them thoroughly with clean water. Seek medical attention immediately.
- ▶ If you swallow fuel, seek medical attention immediately. Do not induce vomiting.
- ▶ Change immediately out of clothing that has come into contact with fuel.

**⚠ WARNING** Risk of fire and explosion due to electrostatic charge

Electrostatic charge can ignite fuel vapor.

- ▶ Before you open the fuel filler cap or take hold of the pump nozzle, touch the metallic vehicle body.
- ▶ To avoid creating another electrostatic charge, do not get into the vehicle again during the refueling process.

**!** **NOTE** Damage caused by the wrong fuel

Vehicles with a gasoline engine:

Even small amounts of the wrong fuel could result in damage to the fuel system, the engine and the emission control system.

- ▶ Refuel only with low-sulfur spark-ignition engine fuel.

This fuel may contain up to 10% ethanol. Your vehicle is suitable for use with E10 fuel.

Never refuel with one of the following fuels:

- Diesel
- Gasoline with more than 10% ethanol by volume (e.g. E15, E85, E100)

- Gasoline with more than 3% methanol by volume (e.g. M15, M30, M85, M100)
- Gasoline with metallic additives

If you have accidentally refueled with the wrong fuel:

- ▶ Do not switch on the vehicle.
- ▶ Consult a qualified specialist workshop.

**!** **NOTE** Do not use diesel to refuel vehicles with a gasoline engine

If you have accidentally refueled with the wrong fuel:

- Do not switch on the vehicle. Otherwise fuel can enter the engine.  
Even small amounts of the wrong fuel could result in damage to the fuel system and the engine. The repair costs are high.
- ▶ Consult a qualified specialist workshop.
- ▶ Have the fuel tank and fuel lines drained completely.

**!** **NOTE** Damage to the fuel system due to overfilling the fuel tank

- ▶ Only fill the fuel tank until the pump nozzle switches off.

If too much fuel has been added due, for example, to a faulty filling pump:

- ▶ Do not switch on the vehicle.
- ▶ Consult a qualified specialist workshop.

**!** **NOTE** Fuel may spray out when you remove the fuel pump nozzle

- ▶ Only fill the fuel tank until the pump nozzle switches off.

**Requirements**

- The vehicle is unlocked.

Observe the notes on service fluids and fuel.

Only refuel with fuel that has at least the octane number specified on the information label on the fuel filler flap. Otherwise, engine output may be reduced and fuel consumption increased.

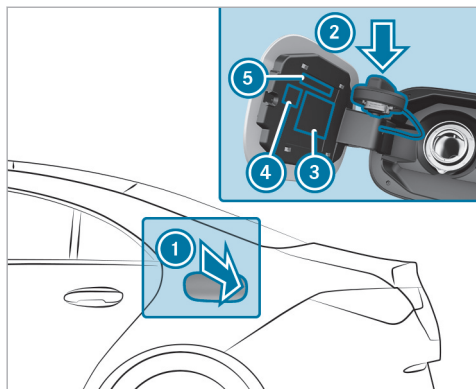

- ① Fuel filler flap
- ② Bracket for fuel filler cap
- ③ Tire pressure table
- ④ QR code for rescue card
- ⑤ Fuel type

▶ Press in the middle on the rearward area of fuel filler flap ①.

- ▶ Turn the fuel filler cap counter-clockwise and remove it.
- ▶ Insert fuel filler cap from above into bracket ②.
- ▶ Completely insert the pump nozzle into the tank filler neck, hook in place and refuel.
- ▶ Only fill the fuel tank until the pump nozzle switches off.
- ▶ Replace the cap on the filler neck and turn clockwise until it engages audibly.
- ▶ Close fuel filler flap ①.

## Parking

### Parking the vehicle

**⚠ WARNING** Risk of accident and injury caused by an insufficiently secured vehicle rolling away

If the vehicle is not securely parked sufficiently, it can roll away in an uncontrolled way even at a slight downhill gradient.

- ▶ On uphill or downhill gradients, turn the front wheels so that the vehicle rolls towards the curb if it starts moving.
- ▶ Apply the parking brake.
- ▶ Switch the transmission to position **P**.

**⚠ WARNING** Risk of fire caused by hot exhaust system parts

Flammable materials such as leaves, grass or twigs may ignite.

- ▶ Park the vehicle so that no flammable material can come into contact with hot vehicle components.
- ▶ In particular, do not park on dry grass-land or harvested grain fields.



**⚠ WARNING** Risk of accident and injury due to children left unattended in the vehicle

If you leave children unattended in the vehicle, they could, in particular:

- open doors, thereby endangering other persons or road users.
- get out and be struck by oncoming traffic.
- operate vehicle equipment and become trapped, for example.

In addition, the children could also set the vehicle in motion by, for example:

- releasing the parking brake.
  - changing the gearbox position.
  - starting the vehicle.
- ▶ Never leave children unattended in the vehicle.
- ▶ When leaving the vehicle, always take the key with you and lock the vehicle.
- ▶ Keep the key out of reach of children.

**! NOTE** Damage to the vehicle due to it rolling away

- ▶ Always secure the vehicle against rolling away.

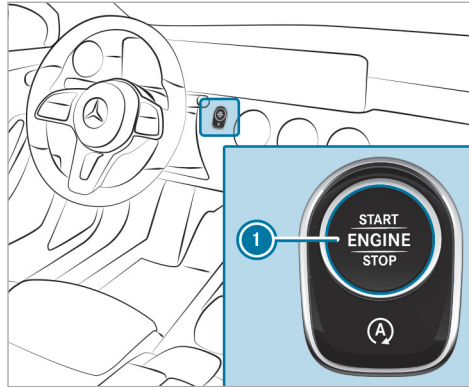

- ▶ Bring the vehicle to a standstill by depressing the brake pedal.

- ▶ On uphill or downhill gradients, turn the front wheels so that the vehicle rolls towards the curb if it starts moving.
- ▶ Apply the electric parking brake.
- ▶ Engage transmission position **[P]** in a stationary vehicle with the brake pedal applied (→ page 152).
- ▶ Switch off the vehicle by pressing button **1**.
- ▶ Release the service brake slowly.
- ▶ Get out of the vehicle and lock it.

**i** When you park the vehicle, you can still operate the side windows and the panoramic sliding sunroof for approximately four minutes if the driver's door is closed.

**Automatic vehicle shut-off when locking**

Your vehicle is equipped with automatic engine shut-off.

When you leave the vehicle ready to drive, the vehicle will be turned off when locked under the following conditions:

- The ignition is switched on or the engine is running.

- Transmission position **P** is engaged.
- The driver's door is closed.
- **In addition, one of the following conditions must be fulfilled:**
  - The vehicle is locked using the vehicle key.
  - **Vehicles with KEYLESS-GO:** the vehicle is locked with KEYLESS-GO on the door handle of a closed door.
  - **Vehicles with KEYLESS-GO:** the vehicle is locked via the locking button in the trunk lid.

**i** The engine will continue to run if the vehicle is not locked as described after it has been left. In this case, switch off the vehicle manually.

#### Automatic switch-off of the vehicle after a period of time (depending on equipment)

When the engine is running, the following display message appears in the driver's display when leaving the vehicle or after a certain time stopped in transmission position **P** : **Vehicle Ready to Drive Shutdown Occurs When Locked or Automatically in XX Mins**

The vehicle will then automatically switch off after a total of 20 minutes of time stopped.

**i** To avoid automatic switch-off after the time has elapsed, confirm the corresponding message in the central display of the multimedia system.

In the following cases, the engine continues to run:

- if the vehicle is not locked as described after leaving it
- if the automatic switch-off is not displayed by the display message
- if, once the time has elapsed, the automatic switch-off has been deactivated via the corresponding message in the central display

In this case, switch off the vehicle manually.

## Garage door opener

### Programming buttons for the garage door opener

**⚠ DANGER** Risk of death caused by exhaust gases

Combustion engines emit poisonous exhaust gases such as carbon monoxide. Inhaling these exhaust gases is hazardous to health and leads to poisoning.

▶ Never leave the engine or, if present, the auxiliary heating running in an enclosed space without sufficient ventilation.

**⚠ WARNING** Risk of injury by becoming trapped when opening and closing a garage door

When you operate or program a garage door with an integrated garage door opener, persons can become trapped or struck by the garage door if they stand within its range of movement.

- ▶ Always make sure that nobody is within the range of the garage door's movement.

Only operate the following doors using the garage door opener:

- Doors with a safety stop and reversing feature
- Doors which conform to the current U.S. safety standards

Before programming the garage door opener, park the vehicle outside the garage. Make sure that the vehicle is switched on but not started.

#### Requirements

- The vehicle has been parked outside the garage or outside the range of movement of the door.
  - The vehicle is switched on.
  - The vehicle has not been started.
- i** The garage door opener function is always available when the vehicle is switched on.

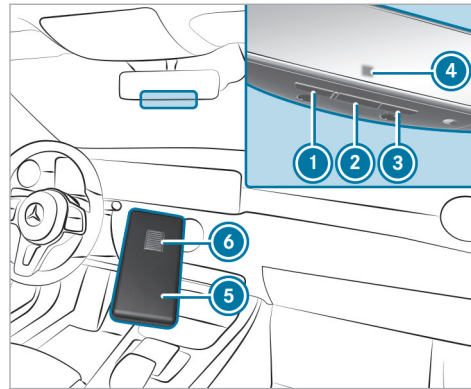

- ▶ Check if the transmitter frequency of the remote control has the frequency range of 280 to 868 MHz.  
Radio equipment approval number:
  - NZLMUAHL5 (USA)
  - 4112A-MUAHL5 (Canada)

- ▶ Press and hold button ①, ② or ③ that you wish to program. Indicator lamp ④ flashes yellow.
  - i** It can take up to 20 seconds before the indicator lamp flashes yellow.
- ▶ Release the previously pressed button. Indicator lamp ④ continues to flash yellow.
- ▶ Point remote control ⑤ from a distance of 0.4 in (1 cm) to 3 in (8 cm) towards button ①, ② or ③.
- ▶ Press and hold button ⑥ of remote control ⑤ until one of the following signals appears:
  - Indicator lamp ④ lights up green continuously. Programming is complete.
  - Indicator lamp ④ flashes green. Programming was successful. Additionally, synchronization of the rolling code with the door system must be carried out.
- ▶ If indicator lamp ④ does not light up or flash green: repeat the procedure.
- ▶ Release all of the buttons.

- i** The remote control for the door drive is not included in the scope of delivery of the garage door opener.

### ■ Synchronizing the rolling code

#### Requirements

- The door system uses a rolling code.
- The vehicle must be within range of the garage door or door drive.
- The vehicle as well as persons and objects are located outside the range of movement of the door.

- ▶ Press the program button on the door drive unit. Initiate the next step within approximately 30 seconds.
- ▶ Press previously programmed button **1**, **2** or **3** repeatedly until the door closes. When the door closes, programming is completed.

- i** Please also read the operating instructions for the door drive.

### ■ Troubleshooting when programming the remote control

- ▶ Check if the transmitter frequency of remote control **5** is supported.
- ▶ Replace the batteries in remote control **5**.
- ▶ Hold remote control **5** at various angles from a distance of 0.4 in (1 cm) to 3 in (8 cm) front of the inside rearview mirror. You should test every position for at least 25 seconds before trying another position.
- ▶ Hold remote control **5** at the same angles at various distances in front of the inside rearview mirror. You should test every position for at least 25 seconds before trying another position.
- ▶ On remote controls that transmit only for a limited period, press button **6** on remote control **5** again before transmission ends.
- ▶ Angle the antenna line of the garage door opener unit toward the remote control.
- i** It is possible that older garage doors cannot be operated using the remote control in the inside rearview mirror even after you have

successfully performed the measures described above. If this is the case, contact the HomeLink® Hotline.

- i** Support and additional information on programming:
  - on the toll free HomeLink® Hotline on 1-800-355-3515
  - on the Internet at <https://www.homelink.com/mercedes>

### ■ Opening or closing the garage door

#### Requirements

- The corresponding button is programmed to operate the door.
- ▶ Press and hold buttons **1**, **2** or **3** until the door opens or closes.
- ▶ If the indicator lamp **4** flashes yellow after approx. 20 seconds: Press the previously pressed button again and keep it pressed until the door opens or closes.

### Clearing the garage door opener memory

- ▶ Press and hold buttons ① and ③.  
Indicator lamp ④ lights up yellow.
- ▶ If indicator lamp ④ flashes green: release buttons ① and ③.  
The entire memory has been deleted.

### Electric parking brake

#### Function of the electric parking brake (applying automatically)

**⚠ WARNING** Risk of accident and injury due to children left unattended in the vehicle

If you leave children unattended in the vehicle, they could, in particular:

- open doors, thereby endangering other persons or road users.
- get out and be struck by oncoming traffic.
- operate vehicle equipment and become trapped, for example.

In addition, the children could also set the vehicle in motion by, for example:

- releasing the parking brake.
  - changing the gearbox position.
  - starting the vehicle.
- ▶ Never leave children unattended in the vehicle.
  - ▶ When leaving the vehicle, always take the key with you and lock the vehicle.
  - ▶ Keep the key out of reach of children.

**The electric parking brake is applied if the transmission is in position **P** and one of the following conditions is fulfilled:**

- The vehicle is switched off.
- The seat belt tongue is not inserted in the seat belt buckle of the driver's seat and the driver's door is opened.

**i** To prevent application: pull the handle of the electric parking brake (→ page 164).

**In the following situations, the electric parking brake is also applied:**

- The HOLD function is keeping the vehicle stationary.
- Active Parking Assist is keeping the vehicle stationary.
- Active Distance Assist DISTRONIC is bringing the vehicle to a standstill.
- **In addition, one of the following conditions must be fulfilled:**
  - The vehicle is switched off.
  - The seat belt tongue is not inserted in the seat belt buckle of the driver's seat and the driver's door is opened.
  - There is a system malfunction.
  - The power supply is insufficient.
  - The vehicle is stationary for a lengthy period.

When the electric parking brake is applied, the red **PARK** (USA) or **(P)** (Canada) indicator lamp lights up in the driver's display.

- ① The electric parking brake is not automatically applied if the vehicle is switched off by the ECO start/stop function.

### ■ Function of the electric parking brake (releasing automatically)

The electric parking brake is released when the following conditions are fulfilled:

- The driver's door is closed.
- The vehicle has been started.
- The transmission is in position **D** or **R** and you depress the accelerator pedal or you shift from transmission position **P** to **D** or **R** when on level ground.
- If the transmission is in position **R**, the trunk lid must be closed.
- The seat belt tongue is inserted into the seat belt buckle of the driver's seat.

If the seat belt tongue is not inserted into the seat belt buckle of the driver's seat, one of the following conditions must be fulfilled:

- You shift from transmission position **P**.
- or

- You have previously driven at speeds greater than 2 mph (3 km/h).

When the electric parking brake is released, the red **PARK** (USA) or **(P)** (Canada) indicator lamp in the driver's display goes out.

### ■ Applying/releasing the electric parking brake manually

#### Applying

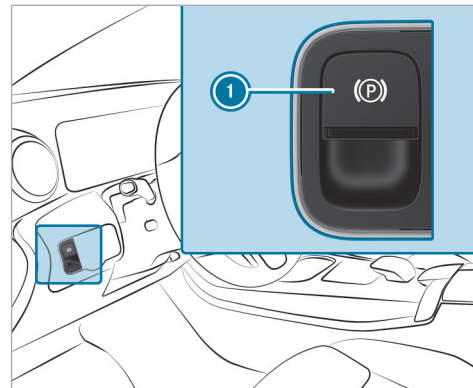

- ▶ Push handle ①.  
The red **PARK** (USA) or **(P)** (Canada) indicator lamp lights up in the driver's display.

- ⓘ The electric parking brake is only securely applied if the red **PARK** (USA) or **(P)** (Canada) indicator lamp is lit continuously.

### Releasing

- ▶ Switch on the vehicle.
- ▶ Pull handle ①.  
The red **PARK** (USA) or **(P)** (Canada) indicator lamp in the driver's display goes out.

### Emergency braking

- ▶ Press and hold handle ①.  
As long as the vehicle is in motion, the **Release Parking Brake** message is displayed and the red **PARK** (USA) or **(P)** (Canada) indicator lamp flashes.  
When the vehicle has been braked to a standstill, the electric parking brake is applied. The red **PARK** (USA) or **(P)** (Canada) indicator lamp lights up in the driver's display.

### Information on collision detection on a parked vehicle

If a collision is detected on the locked vehicle when the tow-away alarm is activated and collision detection is switched on, you will receive a message in the multimedia system when the vehicle is switched on.

You will receive information about the following points:

- The area of the vehicle that may have been damaged.
- The force of the impact.

The following situation can lead to inadvertent activation:

- The parked vehicle is moved, for example, in a two-story garage.
- ⓘ Deactivate the tow-away alarm in order to prevent inadvertent activation. If you deactivate the tow-away alarm, collision detection will also be deactivated.

You can permanently deactivate collision detection via the multimedia system (→ page 166).

- ⓘ If the battery is severely discharged, the function for detecting a collision on a parked vehicle is automatically deactivated to facilitate the next engine start.

### System limits

Detection may be restricted in the following situations:

- the vehicle is damaged without impact, for example, if an outside mirror is torn off or the paint is damaged by a key
- an impact occurs at low speed
- the electric parking brake is not applied
- ⓘ You are responsible for your vehicle. Convince yourself that your vehicle is free of damage and roadworthy.

### Setting collision detection for a parked vehicle

Multimedia system:

→  » Settings » Vehicle  
» Open/Close » Vehicle Protection

▶ Activate or deactivate the function via **Collision Notification**.

- ⓘ A maximum of three incidents can be registered. Up to 15 photos will be taken for every incident. In the event of another incident, the photos of the first incident will be overwritten if they have not been deleted already.

#### Activating/deactivating collision photos

Note the possibility of legal restrictions in some countries regarding automatic recording of the vehicle's surroundings.

▶ Activate or deactivate **Collision Photos**.

#### Transferring the collision photos with the Mercedes me App

- ▶ Select **Upload Collision Photos**.
- ▶ Select **Upload Automatically**.

- ⓘ Any device that has scanned the QR code can be used to view the collision photos in the Mercedes me App.

#### Copying collision photos to a USB flash drive

- ▶ Connect a USB flash drive .
- ▶ Select **Manage Collision Photos**.
- ▶ Select **Copy (USB)**.  
All collision photos will be copied to the USB flash drive.

- ⓘ To ensure secure operation, only use USB storage devices formatted with FAT32 or exFAT.

#### Deleting collision photos

- ▶ Select **Manage Collision Photos**.
- ▶ Select **Delete**.  
All collision photos will be deleted.

#### Notes on parking up the vehicle

If you leave the vehicle parked up for longer than six weeks, it may suffer damage through disuse.

The 12 V battery may also be impaired or damaged by heavy discharging.

Do not disconnect the 12 V battery even if the vehicle is left idle for a lengthy period.

- ⓘ Further information can be obtained at a qualified specialist workshop.

### Standby mode (extension of the starter battery's period out of use)

#### Standby mode function

- ⓘ This function is not available for all models.

If standby mode is activated, energy loss will be minimized during extended periods of non-operation.

Standby mode is characterized by the following:

- The starter battery is preserved.
- The maximum non-operational time appears on the central display.
- The connection to online services is interrupted.



- The ATA (anti-theft alarm system) is not available.
- The interior protection and tow-away alarm functions are not available.
- The function for detecting collisions for a parked vehicle is not available.

If the following conditions are fulfilled, standby mode can be activated or deactivated using the multimedia system:

- The vehicle is switched on.
- The vehicle has not been started.

Exceeding the vehicle's displayed non-operational time may cause inconvenience; i.e. it cannot be guaranteed that the starter battery will reliably start the vehicle.

Charge the starter battery in the following situations:

- The vehicle's non-operational time must be extended.
- The state of charge of the starter battery is insufficient for standby mode.

- ① Standby mode is automatically deactivated when the vehicle is switched on.

### ■ Activating/deactivating standby mode (parking up the vehicle)

#### Requirements

- The power supply is switched on.
- The vehicle is not switched on.

Multimedia system:

→  » Settings » Vehicle  
» Other Functions

▶ Activate or deactivate **Standby Mode**.

## Driving and driving safety systems

### Driving systems and your responsibility

Your vehicle is equipped with driving systems that assist you in driving, parking and maneuvering the vehicle. The driving systems are only aids. They are not a substitute for you paying attention to your surroundings and do not relieve you of your responsibility pertaining to road traffic law. The driver is always responsible for maintaining a safe

distance to the vehicle in front, for vehicle speed, for braking in good time and for staying in lane. Pay attention to the traffic conditions at all times and intervene when necessary. Be aware of the limitations regarding the safe use of these systems.

Driving systems can neither reduce the risk of an accident if you fail to adapt your driving style nor override the laws of physics. They cannot always take into account road, weather or traffic conditions.

- ① Some driving systems can regulate or limit the speed to a previously set value. Draw attention to the stored speed when changing drivers.

### Information on vehicle sensors and cameras

Some driving and driving safety systems use cameras as well as radar or ultrasonic sensors to monitor the area in front of, behind or next to the vehicle.

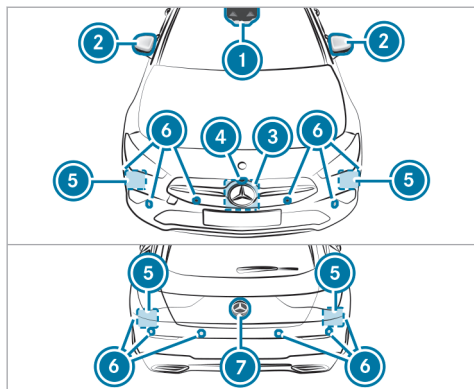

- ① Multifunction camera
- ② Cameras in the outside mirrors
- ③ Front radar
- ④ Front camera
- ⑤ Corner radars
- ⑥ Ultrasonic sensors
- ⑦ Rear view camera

**⚠ WARNING** Risk of accident due to restricted detection performance of vehicle sensors and cameras

If the area around vehicle sensors or cameras is covered, damaged or dirty, certain driving and safety systems cannot function correctly. There is a risk of an accident.

- ▶ Keep the area around vehicle sensors or cameras clear of any obstructions and clean.
- ▶ Have damage to the bumper, radiator grille or stone chipping in the area of the front and rear windows repaired at a qualified specialist workshop.

In particular, keep the areas around the sensors and cameras free of dirt, ice or slush (→ page 286). The sensors and cameras must not be covered and the detection ranges around them must be kept free. Do not attach additional license plate brackets, advertisements, stickers or foils - including those that protect against stone chippings - in the detection range of the sensors

and cameras. Make sure that there are no overhanging loads protruding into the detection range. If there is damage to a bumper or the radiator grille, or after an impact, have the function of the sensors checked at a qualified specialist workshop. Have damage or stone chipping in the area of the cameras on the windshield and rear window repaired at a qualified specialist workshop.

- ⓘ The rear view camera can extend and retract automatically for the purpose of calibration, even though there is no camera image in the display.

#### Overview of driving systems and driving safety systems

- ABS (→ page 169)
- BAS (→ page 169)
- ESP® (→ page 170)
- ESP® Crosswind Assist (→ page 171)
- EBD (→ page 171)
- STEER CONTROL (→ page 172)
- HOLD function (→ page 172)

- Hill Start Assist (→ page 173)
- Start-off assist (→ page 174)
- ATTENTION ASSIST (→ page 174)
- Cruise control (→ page 176)
- Traffic Sign Assist (→ page 193)
- Traffic light view (→ page 196)
- Suspension with adaptive damping adjustment (→ page 201)

### Driving Assistance Package

**i** The following functions are part of the Driving Assistance Package. Certain functions are only available in some countries. Some functions are also available without the Driving Assistance Package, albeit with restricted functionality.

- Active Distance Assist DISTRONIC (→ page 178)
- Active Speed Limit Assist (→ page 182)
- Route-based speed adaptation (→ page 183)
- Active Brake Assist (→ page 188)
- Active Steering Assist (→ page 185)
- Active Emergency Stop Assist (→ page 187)
- Blind Spot Assist with exit warning (→ page 197)
- Active Lane Keeping Assist (→ page 198)

### Parking Package

- i** The availability of individual functions is country- and equipment-dependent.
- Rear view camera (→ page 201)
- 360° camera (→ page 204)
- Parking Assist PARKTRONIC (→ page 208)
- Active Parking Assist (→ page 212)

### Function of ABS

The Anti-lock Brake System (ABS) regulates the brake pressure in critical driving situations:

- During braking, for instance, at maximum full-stop braking or if there is insufficient tire traction, the wheels are prevented from locking.
- Vehicle steerability while braking is ensured.

If ABS intervenes when braking, you will feel a pulsing in the brake pedal. The pulsating brake pedal can be an indication of hazardous road conditions and can serve as a reminder to take extra care while driving.

### System limits

- ABS is active from speeds of approx. 3 mph (5 km/h).
- ABS may be impaired or may not function if a malfunction has occurred and the yellow  ABS warning lamp lights up continuously after the vehicle is started.

### Function of BAS

**⚠ WARNING** Risk of an accident caused by a malfunction in BAS (Brake Assist System)

If BAS is malfunctioning, the braking distance in an emergency braking situation is increased.

- ▶ Depress the brake pedal with full force in emergency braking situations. ABS prevents the wheels from locking.

## 170 Driving and parking

The Brake Assist System (BAS) supports your emergency braking situation with additional brake force.

If you depress the brake pedal quickly, BAS is activated:

- BAS automatically boosts the brake pressure.
- BAS can shorten the braking distance.
- ABS prevents the wheels from locking.

The brakes will function as usual once you release the brake pedal. BAS is deactivated.

### Function of ESP®

**⚠ WARNING** Risk of skidding if ESP® is deactivated

If you deactivate ESP®, ESP® cannot carry out vehicle stabilization.

▶ ESP® should only be deactivated in the following situations.

**!** **NOTE** Mercedes-AMG vehicles

▶ Observe the notes in the Supplement. You could otherwise fail to recognize dangers.

The Electronic Stability Program (ESP®) can monitor and improve driving stability and traction in the following situations within physical limits:

- When you pull away on wet or slippery road surfaces.
- When braking.

If the vehicle deviates from the direction desired by the driver, ESP® can stabilize the vehicle by intervening in the following ways:

- One or more wheels are braked.
- The engine output is adapted according to the situation.

When ESP® is deactivated, the  warning lamp lights up continuously:

- Driving stability will no longer be improved.
- The drive wheels could spin.

- ETS/4ETS traction control is still active.

**i** When ESP® is deactivated, you are still assisted by ESP® when braking.

When the  warning lamp flashes, one or more wheels have reached their grip limit:

- Adapt your driving style to suit the current road and weather conditions.
- Do not deactivate ESP®.
- Only depress the accelerator pedal as far as is necessary when pulling away.

Deactivate ESP® in the following situations to improve traction:

- When using snow chains.
- In deep snow.
- On sand or gravel.

**i** Spinning the wheels results in a cutting action, which enhances traction.

If the  warning lamp lights up continuously, ESP® is not available due to a malfunction.

Observe the following information:

- Warning and indicator lamps (→ page 411)
- Display messages (→ page 358)

### ETS/4ETS

ETS/4ETS (Electronic Traction System) traction control is part of ESP® and makes it possible to pull away and accelerate on slippery roads.

ETS/4ETS can improve the vehicle's traction by intervening in the following ways:

- The drive wheels are braked individually if they spin.
- More drive torque is transferred to the wheel or wheels with traction.

### Influence of drive programs on ESP®

The drive programs enable ESP® to adapt to different weather and road conditions as well as the driver's preferred driving style. Depending on the selected drive program, the appropriate ESP® mode will be activated (→ page 149).

### Function of ESP® Crosswind Assist

ESP® Crosswind Assist detects sudden gusts of side wind and helps the driver to keep the vehicle in the lane:

- ESP® Crosswind Assist is active at vehicle speeds between approx. 50 mph (80 km/h) and 125 mph (200 km/h) when driving straight ahead or cornering slightly.
- The vehicle is stabilized by means of individual brake application on one side.

### Activating/deactivating ESP® (Electronic Stability Program)

Multimedia system:



- ① ESP® can only be activated/deactivated using quick access when at least one other function is available in quick access. ESP® can otherwise be found in the [Assistance](#) menu.

### ! NOTE Mercedes-AMG vehicles

- ▶ Observe the notes in the Supplement. You could otherwise fail to recognize dangers.

- ▶ Select **ESP**.
- ▶ Select **On** or **Off**.

ESP® is deactivated if the ESP® OFF warning lamp  lights up continuously on the driver's display.

Observe any information on warning lamps and display messages which may be shown on the driver's display.

### Function of EBD

Electronic Brakeforce Distribution (EBD) is characterized by the following:

- Monitoring and regulating the brake pressure on the rear wheels.
- Improved driving stability when braking, especially on bends.

### Function of STEER CONTROL

STEER CONTROL assists you by transmitting a noticeable steering force to the steering wheel in the direction required for vehicle stabilization.

This steering recommendation is given in the following situations:

- both right wheels or both left wheels are on a wet or slippery road surface when you brake
- the vehicle starts to skid

#### System limits

STEER CONTROL may be impaired or may not function in the following situations:

- ESP® is deactivated.
- ESP® is malfunctioning.
- The steering is malfunctioning.

If ESP® is malfunctioning, you will be assisted further by the power steering.

### HOLD function

#### HOLD function

The HOLD function holds the vehicle at a standstill without requiring you to depress the brake pedal, e.g. while waiting in traffic.

The HOLD function is only an aid. The responsibility for the vehicle safely standing still remains with the driver.

#### System limits

The HOLD function is only intended to provide assistance when driving and is not a sufficient means of safeguarding the vehicle against rolling away when stationary.

- The incline must not be greater than 30%.

### Activating/deactivating the HOLD function

**▲ WARNING** Risk of an accident due to the HOLD function being active when you leave the vehicle

If the vehicle is only braked with the HOLD function it could, in the following situations, roll away:

- If there is a malfunction in the system or in the power supply.
- If the HOLD function is deactivated by depressing the accelerator pedal or brake pedal, e.g. by a vehicle occupant.

▶ Always secure the vehicle against rolling away before you leave it.

#### Requirements

- The vehicle is stationary.
- The driver's door is closed or the seat belt on the driver's side is fastened.
- The vehicle has been started or has been automatically switched off by the ECO start/stop function.

- The electric parking brake is released.
- Active Distance Assist DISTRONIC is deactivated.
- The transmission is in position **D**, **R** or **N**.

#### Activating the HOLD function

- ▶ Depress the brake pedal, and after a short time quickly depress further until the **HOLD** display appears in the driver's display.
- ▶ Release the brake pedal.

#### Deactivating the HOLD function

- ▶ Depress the accelerator pedal to pull away.
- or
- ▶ Depress the brake pedal until the **HOLD** display disappears from the driver's display.

The HOLD function is deactivated in the following situations:

- Active Distance Assist DISTRONIC is activated.
- The transmission is shifted to position **P**.
- The vehicle is secured with the electric parking brake.

In the following situations, the vehicle is held by transmission position **P** and/or by the electric parking brake:

- The seat belt is unfastened and the driver's door is opened.
- The vehicle is switched off.
- There is a system malfunction.
- The power supply is insufficient.

In addition, the **Brake Immediately** message may appear in the driver's display and a horn tone may sound at regular intervals.

- ▶ Immediately depress the brake pedal firmly until the warning message disappears. The HOLD function is deactivated.
- ▶ Additionally secure the vehicle against rolling away.

#### Function of Hill Start Assist

**⚠ WARNING** Risk of accident and injury due to the vehicle rolling away

After a short time, Hill Start Assist no longer holds the vehicle.

- ▶ Swiftly move your foot from the brake pedal to the accelerator pedal. Do not leave the vehicle when it is being held by Hill Start Assist.

Hill Start Assist will hold the vehicle for a short time when you pull away on a hill in the following circumstances:

- The transmission is in position **D** or **R**.
- The electric parking brake is released.

This will give you enough time to move your foot from the brake pedal to the accelerator pedal and depress it before the vehicle begins to roll away.

### Start-off assist

#### Function of the start-off assist

The start-off assist enables optimal vehicle acceleration from a standstill. For this, a suitably high-grip road surface is required and the tires and vehicle must also be in good condition.

Do not activate the start-off assist on public roads.

Be sure to observe the safety notes and information on ESP® (→ page 170).

#### Activating the start-off assist

**▲ WARNING** Risk of skidding and having an accident from wheels spinning

When you use start-off assist, individual wheels could spin and you could lose control of the vehicle.

If ESP® is deactivated, there is a risk of skidding and accident!

- ▶ Make sure that no persons or obstacles are in the close vicinity of your vehicle.

- ▶ Deactivating ESP® (→ page 171).
- ▶ Move the steering wheel to the straight-ahead position.
- ▶ Depress the brake pedal firmly with your left foot and keep it depressed.
- ▶ Engage the **D** drive position (→ page 153).
- ▶ Select the sportiest available drive program **S+** or **S** (→ page 149).
- ▶ Rapidly depress the accelerator pedal fully.
- ▶ Take your foot off the brake, but keep the accelerator pedal depressed. The vehicle pulls away at maximum acceleration.
- ▶ Switch on ESP® once the acceleration procedure is complete. ESP® will otherwise not be able to stabilize the vehicle if the vehicle starts to skid or a wheel starts to spin.

#### Canceling the start-off assist

- ▶ Remove your foot from the accelerator pedal.
- ▶ Reactivate the ESP®.

### ATTENTION ASSIST

#### Function of ATTENTION ASSIST

ATTENTION ASSIST helps you on long, monotonous journeys, e.g. on highways and trunk roads. If indicators of fatigue or increasing lapses in concentration on the part of the driver are detected, the system will suggest taking a break.

ATTENTION ASSIST is only an aid. It cannot always detect fatigue or lapses in concentration in time. The system is not a substitute for a well-rested and attentive driver. On long journeys, take regular breaks in good time that allow for adequate recuperation.

You can choose between two settings:

- **Standard:** normal system sensitivity.
- **Sensitive:** higher system sensitivity. The driver is warned earlier and the attention level detected by ATTENTION ASSIST is adapted accordingly.

If drowsiness or increasing lapses in concentration are detected, the **ATTENTION ASSIST: Take a Break!** warning appears on the driver's display. You can acknowledge the message and take a



break where necessary. If you do not take a break and ATTENTION ASSIST continues to detect increasing lapses in concentration, you will be warned again after a minimum of 15 minutes.



The following information is displayed on the driver's display:

- The length of the journey since the last break
- The attention level determined by ATTENTION ASSIST.

The more segments ① of the circle displayed, the higher the detected attention level. Fewer segments ① are displayed in the circle as the attention level decreases.

If ATTENTION ASSIST is unable to calculate the attention level and cannot issue a warning, the **System Suspended** message appears.

If a warning is shown on the driver's display, the MBUX multimedia system offers to search for a rest area. You can select a rest area and start navigation to this rest area.

When you restart the vehicle, ATTENTION ASSIST is automatically switched on. The last selected sensitivity level remains stored.

#### System limits

ATTENTION ASSIST is active in the speed range between 37 mph (60 km/h) and 124 mph (200 km/h).

If the system is not available due to a fault, the ATTENTION ASSIST warning lamp  will light up permanently on the driver's display

Particularly in the following situations, ATTENTION ASSIST only functions in a restricted manner and warnings may be delayed or not occur:

- If you have been driving for less than approximately 30 minutes.

- If the road condition is poor (uneven road surface or potholes).
- If there is a strong crosswind.
- If you adopt a sporty driving style (high cornering speeds or high rates of acceleration).
- If the Steering Assist function of Active Distance Assist DISTRONIC is active.
- If the clock is set to the incorrect time.
- If you change lanes and vary your speed frequently in active driving situations.

Also observe any information regarding display messages that may be displayed on the driver's display.

The ATTENTION ASSIST drowsiness or alertness assessment is reset and restarted when continuing the journey in the following situations:

- You switch off the vehicle.
- You unfasten your seat belt and open the driver's door (e.g. to change drivers or take a break).

## Setting ATTENTION ASSIST

Multimedia system:

- 





**Settings**

**Assistance**

**Assistance**

**ATTENTION ASSIST**

### Setting the sensitivity

-  Select  next to **ATTENTION ASSIST**.
-  Select **Standard** or **Sensitive**.

## Speed control cruise control

### Function of cruise control

Cruise control regulates the speed to the value selected by the driver.

If you accelerate to overtake, for example, the stored speed is not deleted. If you remove your foot from the accelerator pedal after overtaking, cruise control will resume speed regulation back to the stored speed.

You can store any speed from 15 mph (20 km/h) up to the maximum design speed.

Observe the notes on driving systems and your responsibility; you may otherwise fail to recognize dangers (→ page 167).

**Mercedes-AMG vehicles:** cruise control is available up to a maximum speed of 155 mph (250 km/h).

### Displays on the driver's display

 **Gray:** cruise control is selected but not yet active, or temporarily passive.

 **Green:** cruise control is active.

A stored speed is shown under the  display and is indicated in the speedometer.

### System limits

Cruise control may be unable to maintain the stored speed on uphill gradients. The stored speed is resumed when the gradient evens out.

Change to a lower gear in good time for long and steep downhill gradients. Take particular note of this when driving a laden vehicle. By doing so, you will make use of the braking effect of the engine. This relieves the load on the brake system and prevents the brakes from overheating and wearing too quickly.

Do not use cruise control in the following situations:

- In traffic situations which require frequent changes of speed, e.g. in heavy traffic, on winding roads
- On slippery roads. Accelerating can cause the drive wheels to lose traction and the vehicle could then skid.
- When visibility is poor

## Operating cruise control

 **WARNING** Risk of accident due to stored speed

If you call up the stored speed and this is lower than your current speed, the vehicle decelerates.

-  Take into account the traffic situation before calling up the stored speed.

### Requirements

- Cruise control is selected.
- ESP® must be activated, but not intervening.

- The vehicle speed is at least 15 mph (20 km/h).
- The transmission is in position **D**.

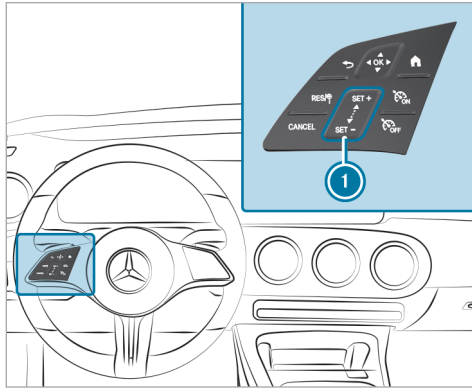

Steering wheel control panel for cruise control

RES/+

Adopts the stored/detected speed

CANCEL

Deactivates cruise control

1

SET+ SET-

Control panel for increasing/  
decreasing speed



Activates cruise control



Deactivates cruise control

### Activating cruise control

- ▶ Press .

### Activating cruise control

- ▶ Press or on control panel 1. The current speed will be stored and maintained by the vehicle.

or

- ▶ Press .
- The last stored speed will be called up and maintained by the vehicle.
- If the last stored speed has previously been deleted, the current vehicle speed will be stored.

- ⓘ When you switch off the vehicle, the last speed stored will be deleted.

### Increasing/decreasing the stored speed

- ▶ To increase the stored speed: swipe upwards from the bottom of control panel 1.
  - The stored speed will be increased by 1 mph (1 km/h).
- ▶ To decrease the stored speed: swipe downwards from the top of control panel 1.
  - The stored speed will be decreased by 1 mph (1 km/h).

or

- ▶ Briefly press or on control panel 1.

The stored speed will be increased or decreased to the following values depending on the unit:

- **mph:** the next value ending in 5
- **km/h:** the next value ending in 0

or

- ▶ Accelerate the vehicle to the desired speed.
- ▶ Press on control panel 1.

### Adopting a detected speed

If cruise control is activated and Traffic Sign Assist has detected a traffic sign with a maximum

permissible speed and this is displayed on the driver's display:

▶ Press **RES/⏪**.

The maximum permissible speed shown by the traffic sign will be stored and the vehicle will maintain that speed.

#### Deactivating cruise control

▶ Press **CANCEL**.

#### Deactivating cruise control

▶ Press **ESP OFF**.

ⓘ If you brake or deactivate ESP® or if ESP® intervenes, cruise control will be deactivated.

### Active Distance Assist DISTRONIC

#### Function of Active Distance Assist DISTRONIC

Active Distance Assist DISTRONIC maintains the set speed on free-flowing roads. If vehicles are detected ahead, the set distance is maintained, if necessary until the vehicle comes to a standstill. The vehicle accelerates or brakes depending on

the distance to the vehicle in front and the set speed.

The speed and distance to the vehicle in front are set and saved using the steering wheel.

Available speed range: 15 mph (20 km/h) - 100 mph (160 km/h)

Other features of Active Distance Assist DISTRONIC:

- Adjusts the driving style depending on the selected drive program (energy-saving, comfortable or dynamic) (→ page 148)
- Initiates acceleration to the stored speed if the turn signal indicator is switched on to change to the overtaking lane
- **Vehicles with Driving Assistance Package:**
  - Reacts to stationary vehicles detected in the urban speed range (except bicycles and motorcycles)
  - Takes into account one-sided overtaking restrictions on highways or multi-lane roads with separate roadways (country-dependent)

If the vehicle has been braked to a standstill on multi-lane roads with separate roadways by Active Distance Assist DISTRONIC, it can automatically follow the vehicle in front when it drives off again, depending on its equipment. If a critical situation is detected when driving off, a visual and acoustic warning is given indicating that the driver must now take control of the vehicle. The vehicle is not accelerated any further.

Observe the notes on driving systems and your responsibility; you may otherwise fail to recognize dangers (→ page 167).

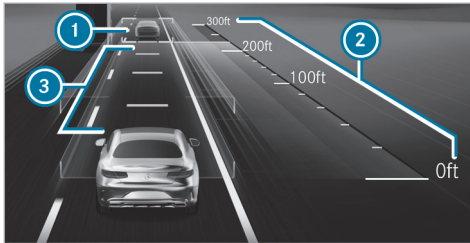

Display in the driver's display in the [Assistance](#) menu

- ① Vehicle in front
- ② Distance indicator
- ③ Set specified distance

Vehicle detected in front ① is highlighted in green. It may also be in the lane to the left of your vehicle in situations where overtaking on the right is not permitted (e.g. on highways).

#### Permanent status display

**Gray:** Active Distance Assist DISTRONIC selected but not yet active.

**Green speedometer, gray vehicle:** Active Distance Assist DISTRONIC active, speed set.

**Green:** Active Distance Assist DISTRONIC active and vehicle detected.

The stored speed is shown under the permanent status display and highlighted on the speedometer. When Active Distance Assist DISTRONIC is passive, the status display is grayed out.

If the speed of the vehicle in front or the speed adjustment is less than the stored speed due to the route event ahead, the segments in the speedometer light up.

When the specified distance set ③ is increased or reduced, the display briefly appears.

- ① On highways or high-speed major roads, the green vehicle symbol is displayed cyclically when the vehicle is ready to pull away.
- ① If you depress the accelerator pedal beyond the setting of the Active Distance Assist DISTRONIC, the system is switched to passive mode. The following message appears briefly on the driver's display **Suspended**.

#### System limits

The system may be impaired or may not function in the following instances:

- In snow, rain, fog, heavy spray, direct sunlight or greatly varying ambient light, or if there is glare.
- If the windshield in the area of the camera is dirty, fogged up, damaged or covered.
- If the radar sensors are dirty or covered.
- In parking garages or on roads with steep uphill or downhill gradients.
- If there are narrow vehicles in front, such as bicycles or motorcycles.

In addition, on slippery roads, braking or accelerating can cause one or several wheels to lose traction and the vehicle could then skid.

Do not use Active Distance Assist DISTRONIC in these situations.

**⚠ WARNING** Risk of accident from acceleration or braking by Active Distance Assist DISTRONIC

Active Distance Assist DISTRONIC may accelerate or brake in the following cases, for example:

- If the vehicle pulls away using Active Distance Assist DISTRONIC.
- If the stored speed is called up and is considerably faster or slower than the currently driven speed.
- If Active Distance Assist DISTRONIC no longer detects a vehicle in front or does not react to relevant objects.

- ▶ Always carefully observe the traffic conditions and be ready to brake at all times.
- ▶ Take into account the traffic situation before calling up the stored speed.

**⚠ WARNING** Risk of accident due to insufficient deceleration by Active Distance Assist DISTRONIC

Active Distance Assist DISTRONIC brakes your vehicle with up to 50% of the possible deceleration. If this deceleration is not sufficient, Active Distance Assist DISTRONIC alerts you with a visual and acoustic warning.

- ▶ Adjust your speed and maintain a suitable distance from the vehicle in front.
- ▶ Brake the vehicle yourself and/or take evasive action.

**⚠ WARNING** Risk of accident if detection function of Active Distance Assist DISTRONIC is impaired

Active Distance Assist DISTRONIC does not react or has a limited reaction:

- when driving on a different lane or when changing lanes

- to pedestrians, animals, bicycles or stationary vehicles, or unexpected obstacles
- to complex traffic conditions
- to oncoming vehicles and crossing traffic

As a result, Active Distance Assist DISTRONIC may neither give warnings nor intervene in such situations.

- ▶ Always observe the traffic conditions carefully and react accordingly.

### ■ Operating Active Distance Assist DISTRONIC

#### Requirements

- The electric parking brake is released.
- ESP® is activated and is not intervening.
- The transmission is in position **D**.
- All the doors are closed.
- The check on the radar sensor system has been completed successfully.

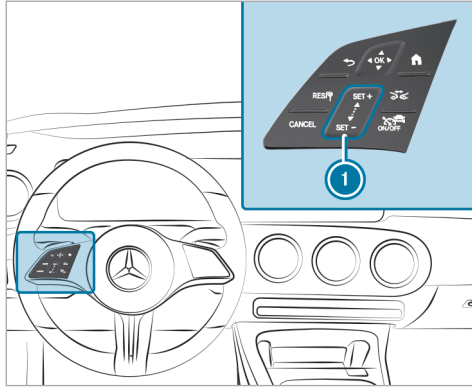

RES/Ⓟ

Adopts the stored/detected speed  
Deactivates Active Distance Assist  
DISTRONIC

CANCEL

① SET+ SET-

Control panel for increasing/  
decreasing speed



Increases/decreases the specified  
distance



Activates/deactivates Active Dis-  
tance Assist DISTRONIC

- ▶ To operate Active Distance Assist DISTRONIC: press the respective button with only one finger or swipe on the control panel.

### Activates/deactivates Active Distance Assist DISTRONIC

- ▶ Press .

### Activating Active Distance Assist DISTRONIC

- ▶ To activate without a stored speed: press on the upper section or on the lower section of control panel ① or press . Remove your foot from the accelerator pedal.

or

- ▶ To activate with a stored speed: press . Remove your foot from the accelerator pedal. The last stored speed will be called up and maintained by the vehicle. If the stored speed has been deleted, the current vehicle speed will be stored.

### Increasing or reducing the speed

- ▶ To increase the stored speed: swipe upwards from the bottom of control panel ①.
  - The stored speed will be increased by 1 mph (1 km/h).
- ▶ To decrease the stored speed: swipe downwards from the top of control panel ①.
  - The stored speed will be decreased by 1 mph (1 km/h).



or

- ▶ Briefly press on the upper section or on the lower section of control panel ①. The stored speed will be increased or reduced by 5 mph (10 km/h).

or

- ▶ Accelerate the vehicle to the desired speed.
- ▶ Press on the upper section of control panel ①.

### Adopting the limit speed shown on the driver's display

▶ To activate Active Distance Assist DISTRONIC: press ,  or .

▶ To accept the displayed speed limit: press .

The limit speed shown on the driver's display will be adopted as the stored speed. The vehicle will adapt its speed to that of the vehicle in front, but only up to the stored speed, or will limit its speed accordingly.

ⓘ A speed limit shown on the driver's display will be adopted only during travel, not when the vehicle is stationary.

### Pulling away with Active Distance Assist DISTRONIC

▶ Activate Active Distance Assist DISTRONIC and remove your foot from the brake pedal.

▶ Press .

or

▶ Depress the accelerator pedal briefly and firmly.  
The functions of Active Distance Assist DISTRONIC will still be active.

### Reducing or increasing the specified distance from the vehicle in front

▶ Press .

The  indicator will appear. The specified distance will be reduced by one level.

If the lowest level is already selected, the selection will jump to the highest level.

### Deactivates Active Distance Assist DISTRONIC

**⚠ WARNING** Risk of an accident due to Active Distance Assist DISTRONIC being active when you leave the driver's seat

If you leave the driver's seat while the vehicle is being braked by Active Distance Assist DISTRONIC only, the vehicle can roll away.

▶ Always deactivate Active Distance Assist DISTRONIC and secure the vehicle to

prevent it from rolling away before you leave the driver's seat.

▶ Press .

ⓘ If you brake or deactivate ESP<sup>®</sup> or if ESP<sup>®</sup> intervenes, Active Distance Assist DISTRONIC will be deactivated.

### Function of Active Speed Limit Assist

If a change in speed limit is detected and the automatic adoption of speed limits is switched on, this will automatically be adopted as the stored speed (→ page 184). Speed limits below 12 mph (20 km/h) will not be adopted.

The vehicle's speed will be adjusted when the vehicle is level with the traffic sign at the latest. In the case of signs indicating entry into an urban area, the speed will be adapted according to the speed permitted within the urban area. The speed limit indicator on the driver's display will always be updated when the vehicle is level with the traffic sign.

If you are driving on a German freeway and there is no speed limit, the system will use the speed stored for a stretch of road with no speed limit as



the set speed. If you do not alter the stored speed on a stretch of road with no speed limit, the recommended speed of 80 mph (130 km/h) will be adopted.

If Active Distance Assist DISTRONIC has been put into passive mode by pressing the accelerator pedal, only speed limits which are higher than the set speed are adopted.

The maximum permissible speed does not take the road condition or current weather and traffic conditions into account. Adjust your speed accordingly as and when necessary.

Observe the notes on driving systems and your responsibility; you may otherwise fail to recognize dangers (→ page 167).

### System limits

The system limits of Traffic Sign Assist apply to the detection of traffic signs (→ page 193).

Speed limits below 12 mph (20 km/h) will not automatically be adopted by the system as the stored speed. Temporary speed restrictions (e.g. for a certain time or due to weather conditions) cannot be properly detected by the system.

Adjust your speed in these situations.

**⚠ WARNING** Risk of accident due to adjustment of speed by Active Speed Limit Assist.

The speed adopted by the Active Speed Limit Assist may be too high or incorrect in individual cases:

- At limit speeds below 12 mph (20 km/h)
- In wet or foggy conditions
- ▶ Ensure that the speed being driven always complies with the traffic laws.
- ▶ Adjust the speed being driven to the current traffic and weather conditions.

### Function of route-based speed adaptation

When Active Distance Assist DISTRONIC is activated, the vehicle speed will be adapted accordingly to the route events ahead. Depending on the drive program selected, the vehicle will negotiate a route event ahead in an energy-saving, comfortable or dynamic manner. When the route event has been passed, the vehicle will accelerate again to the stored speed. The set distance to the vehicle

in front, vehicles detected ahead and speed restrictions ahead will be taken into account.

Route-based speed adaptation can be activated in the multimedia system (→ page 184).

The following route events will be taken into account:

- Bends
- Traffic circles
- T-intersections
- Turns and exits

Also, the speed will be reduced if the turn signal indicator is switched on and one of the following situations is detected:

- Turning off at intersections
- Driving in slowing-down lanes
- Driving in lanes adjacent to slowing-down lanes

The driver is responsible for choosing the right speed and observing other road users. This applies in particular to intersections, traffic circles

and traffic lights, as route-based speed adaptation does not brake the vehicle to a standstill.

When route guidance is active, the first speed adjustment will be carried out automatically. If the turn signal indicator is switched on, the selected route will be confirmed and further speed adjustment will be activated.

Speed adjustment will be canceled in the following cases:

- If the turn signal indicator is switched off before the route event and it is therefore assumed that the route event is not relevant to the driver
- If the driver depresses the accelerator or brake pedal during the process

#### System limits

Route-based speed adaptation does not take right of way regulations into account. The driver is responsible for complying with road traffic regulations and driving at a suitable speed.

In difficult conditions, the speed selection made by the system may not always be suitable. This applies to the following situations, for example:

- The road's course is not clearly visible
- Road narrowing
- Varying maximum permissible speeds in individual lanes, e.g. at toll stations
- Wet road surfaces, snow or ice

The driver will need to intervene accordingly in these situations.

#### **WARNING** Risk of accident in spite of route-based speed adaptation

Route-based speed adaptation can malfunction or be temporarily unavailable in the following situations:

- If the driver does not follow the calculated route
- If map data is not up-to-date or available
- In the event of roadworks
- In bad weather or road conditions

- If the accelerator pedal is depressed
- In the event of electronically displayed speed limitations

▶ Adapt the speed to the traffic situation.

#### **Setting Active Distance Assist DISTRONIC driving styles**

##### Requirements

- Active Distance Assist DISTRONIC is activated.

Multimedia system:

  [Settings](#)  [Assistance](#)  
 [Driving](#)  [Active Distance Assist](#)

##### Setting speed adjustment

▶ Select [Adopt Speed Limit](#) or [Route-based Speed Adaptation](#).

When these functions are active, the vehicle speed will be adjusted depending on the route events ahead.

- ❗ If one of the following systems is activated, the detected speed can be manually adopted as the speed limit:
  - Active Distance Assist DISTRONIC
  - Variable limiter
- ❗ Further information on speed adjustment (→ page 183).

## Active Steering Assist







### Function of Active Steering Assist

Active Steering Assist is available only up to a speed of 100 mph (160 km/h). The system helps you to stay in the center of the lane by means of moderate steering interventions. Depending on the speed driven, Active Steering Assist uses the vehicles ahead and lane markings as a reference.

- ❗ Depending on the country, in the lower speed range Active Steering Assist can use the surrounding traffic as a reference. If necessary, Active Steering Assist can then also provide assistance when you are driving outside the center of the lane (e.g. to form an emergency corridor).

If the detection of lane markings and vehicles ahead is impaired, Active Steering Assist switches to passive mode. The system provides no support in this case.

### Status display of Active Steering Assist

-  **Gray:** activated and passive
  -  **Green:** activated and active
  -  **Red:** system limits detected
  -  **White, red hands:** "hands on the steering wheel" prompt
- ❗ During the transition from active to passive status, the  symbol is shown as enlarged and flashing. Once the system is passive, the  symbol is shown as gray in the driver's display.
  - ❗ Depending on the selected vehicle settings, Active Steering Assist may be unavailable.

### Steering and touch detection

The driver is required to keep their hands on the steering wheel at all times and be able to intervene at any time to correct the course of the vehicle and keep it in lane. The driver must expect a

change from active to passive mode or vice versa at any time.

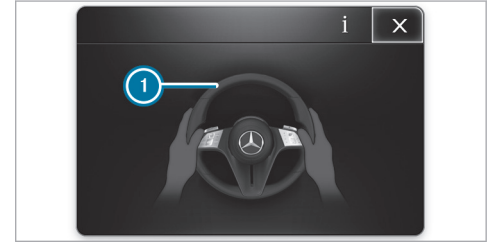

If the system detects that the driver has not steered the vehicle for a considerable period of time or has removed their hands from the steering wheel, display ❶ appears. If the driver still does not steer the vehicle, a warning tone sounds in addition to the visual warning message.

If the driver does not react to this warning for a considerable period, an emergency stop is initiated (→ page 187).

The warning is not issued or is stopped as soon as the system detects that the driver is touching or steering the steering wheel.

Touch detection may be limited or may not function if there is no direct contact between hand and steering wheel (e.g. if you are wearing gloves or if there is a steering wheel cover on the steering wheel).

If Active Steering Assist detects that a system limit has been reached, a visual warning is issued and a warning tone sounds.

Observe the notes on driving systems and your responsibility; you may otherwise fail to recognize dangers (→ page 167).

### System limits

Active Steering Assist has a limited steering torque for lateral guidance. In some cases, the steering intervention is not sufficient to keep the vehicle in the lane or to drive through exits.

The system may be impaired or may not function in the following instances:

- There is poor visibility, e.g. due to snow, rain, fog, heavy spray, greatly varying ambient light or strong shadows on the road.
- There is glare, e.g. from oncoming traffic, direct sunlight or reflections.

- Insufficient road illumination.
- The windshield is dirty, fogged up, damaged or covered in the vicinity of the camera, e.g. by a sticker.
- No, or several, unclear lane markings are present for one lane, or the markings change quickly (e.g. in a construction area or at intersections).
- The lane markings are worn away, dark or covered up, e.g. by dirt or snow.
- If the distance to the vehicle in front is too short and thus the lane markings cannot be detected.
- The road is narrow and winding.
- There are obstacles on the lane or projecting out into the lane, such as object markers.

The system does not provide assistance in the following conditions:

- On tight bends and when turning.
- When crossing intersections.
- At traffic circles or toll stations.
- When the tire pressure is too low.

#### **⚠ WARNING** Risk of accident if Active Steering Assist unexpectedly stops functioning

If the system limits of Active Steering Assist are reached there is no guarantee that the system will remain active or will keep the vehicle in lane.

- ▶ Always keep your hands on the steering wheel and observe the traffic carefully.
- ▶ Always steer the vehicle paying attention to traffic conditions.

#### **⚠ WARNING** Risk of accident if Active Steering Assist unexpectedly intervenes

The detection of lane markings and objects may malfunction and cause unexpected steering interventions.

- ▶ Steer according to traffic conditions.

### ■ Activating/deactivating Active Steering Assist

#### Requirements

- ESP® is activated, but is not intervening.

- Active Distance Assist DISTRONIC is activated.

Multimedia system:

→  » Settings » Assistance  
» Driving

▶ Activate or deactivate **Active Steering Assist**.

### Function of Active Emergency Stop Assist

**i** The following function is available only in combination with the Driving Assistance Package.

Active Emergency Stop Assist monitors the steering wheel and the accelerator and brake pedals. If the system detects a lack of driver activity and the vehicle threatens to leave its lane, a warning can be issued and an emergency stop initiated.

If Active Steering Assist is switched off, the system is available from a speed of approx. 37 mph (60 km/h).

If the vehicle is threatening to leave its lane, a warning is issued in the following cases:

- The driver does not touch the steering wheel for an extended period of time or no steering

movement can be measured for an extended period of time (depending on the vehicle equipment).

- Neither the accelerator nor the brake pedal is being depressed.
- i** If Active Steering Assist is switched on and active, only the steering wheel is monitored by the system. If the driver does not touch the steering wheel for an extended period of time, a warning may be given despite pedal actuation. Also observe the instructions on touch detection as part of Active Steering Assist (→ page 185).



Active Emergency Stop Assist issues the following warnings in order:

- Display **1** appears on the driver's display.
- In addition to display **1**, a warning tone sounds.
- The message **Initiating Emergency Stop** appears on the driver's display, a continuous warning tone sounds, the vehicle no longer accelerates and, if necessary, slight belt tensioning is carried out.
- The vehicle speed is reduced in increments until it is at a standstill. Sharp brake impulses are also produced.

When automatic braking is initiated, Active Distance Assist DISTRONIC is deactivated. Depending on the country, the hazard warning light system is also switched on.

When the vehicle has been brought to a standstill:

- The vehicle is secured with the electric parking brake.
- The vehicle is unlocked.

- If possible, an emergency call is placed to the Mercedes-Benz emergency call center.

Before message **Initiating Emergency Stop** appears, you can cancel Active Emergency Stop Assist by steering.

After message **Initiating Emergency Stop** has appeared, you can cancel Active Emergency Stop Assist as follows:

- Accelerating or braking: the emergency stop is canceled, but the warning message, warning tone and power steering remain active.
- Steering: power-assisted steering is canceled, the warning message and warning tone remain active and the vehicle continues to be braked.
- Steering, accelerating or braking: The emergency stop and electric power steering are canceled. The warning message and warning tone are canceled.

**i** Active Emergency Stop Assist can initiate an emergency stop a maximum of three times within a driving cycle. After that, Active Steering Assist and Active Emergency Stop Assist

are disabled until the vehicle has been restarted.

### System limits

For the detection of vehicles and other obstacles, observe the system limits of the following functions:

- Active Distance Assist DISTRONIC (→ page 178)
- Active Steering Assist (→ page 185)
- Active Lane Keeping Assist (→ page 198)
- Active Brake Assist (→ page 188)

Active Emergency Stop Assist is inactive in the following case:

- Active Lane Keeping Assist and Active Steering Assist are deactivated.

## Active Brake Assist

### Function of Active Brake Assist

Active Brake Assist consists of the following functions:

- Collision warning
- Autonomous braking function
- Situation-dependent brake force boosting
- **Vehicles with Driving Assistance Package:** Active Evasion Assist

Active Brake Assist can help you to minimize the risk of a collision with vehicles, cyclists or pedestrians or to reduce the effects of such a collision. If Active Brake Assist has detected a risk of collision, a warning tone will sound and the Active Brake Assist warning lamp  will light up.

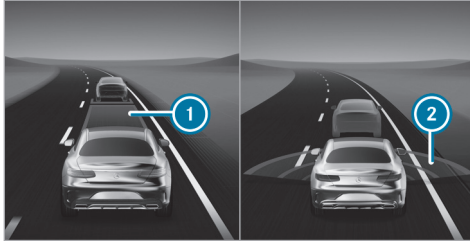

Display on the driver's display in the **Assistance** menu

In the **Assistance** menu, an insufficient distance to the vehicle in front ① is displayed in red. If you further reduce the distance, the vehicle in front is also highlighted in red. When the system detects a risk of collision, red radar waves ② will appear in front of the vehicle.

**i Vehicles with PRE-SAFE®:** depending on the country, an additional haptic warning will occur in the form of slight, repeated tensioning of the seat belt on the driver's side.

If you do not react to the warning, autonomous braking can be initiated in critical situations.

In particularly critical situations, Active Brake Assist can also initiate autonomous braking directly. In this case, the warning tone and the distance warning lamp  will occur at the same time as the brake application.

If you apply the brakes yourself in a critical situation or apply the brakes during autonomous braking, situation-dependent brake force boosting will occur. The brake pressure increases up to maximum full-stop braking if necessary.



If autonomous braking, situation-dependent brake force boosting or an evasive maneuver has been carried out, pop-up ① will appear on the driver's

display. It will disappear automatically after a short time.

If the autonomous braking function or situation-dependent brake force boosting is triggered, preventive measures for occupant protection (PRE-SAFE®) may also be initiated.

**⚠ WARNING** Risk of an accident caused by limited detection performance of Active Brake Assist

Active Brake Assist cannot always clearly identify objects and complex traffic situations.

In such cases, Active Brake Assist might:

- Give a warning or brake without reason
- Not give a warning or not brake

Active Brake Assist is only an aid. The driver is responsible for maintaining a sufficiently safe distance to the vehicle in front, vehicle speed and for braking in good time.

▶ Always pay careful attention to the traffic situation; do not rely on Active Brake Assist alone.

- ▶ Be prepared to brake or swerve if necessary.

If Active Brake Assist is deactivated or the range of functions is restricted, e.g. due to activation of another driving system, the Active Brake Assist warning lamp  will appear on the driver's display.

If the system is unavailable due to dirty or damaged sensors or due to a malfunction, or if the range of functions is restricted, the Active Brake Assist warning lamp  will appear on the driver's display.

Also observe the system limits of Active Brake Assist.

### Collision warning

The collision warning can aid you in the following situations with an intermittent warning tone and the  warning lamp:

- At speeds up to approximately 155 mph (250 km/h) when approaching vehicles ahead
- At speeds up to approximately 50 mph (80 km/h) when approaching stationary vehi-

cles, pedestrians walking in the direction of travel and cyclists ahead

- At speeds up to approximately 43 mph (70 km/h) when approaching crossing pedestrians and cyclists
- At speeds up to approximately 37 mph (60 km/h) when approaching stationary pedestrians and cyclists

### Autonomous braking function

From a speed of approximately 4 mph (7 km/h), the autonomous braking function may intervene in the following situations:

- At speeds up to approximately 155 mph (250 km/h) when approaching vehicles ahead
- At speeds up to approximately 50 mph (80 km/h) when approaching cyclists ahead, pedestrians walking in the direction of travel and stationary vehicles
- At speeds up to approximately 43 mph (70 km/h) when approaching crossing pedestrians and cyclists

### Situation-dependent brake force boosting

From a speed of approximately 4 mph (7 km/h), situation-dependent brake force boosting may intervene in the following situations:

- At speeds up to approximately 155 mph (250 km/h) when approaching vehicles ahead
- At speeds up to approximately 50 mph (80 km/h) when approaching cyclists ahead, pedestrians walking in the direction of travel and stationary vehicles
- At speeds up to approximately 43 mph (70 km/h) when approaching crossing pedestrians and cyclists
- At speeds up to approximately 37 mph (60 km/h) when approaching stationary pedestrians and cyclists

### Canceling a brake application by Active Brake Assist

You can cancel a brake application by Active Brake Assist at any time:

- by sharply depressing the accelerator pedal or with kickdown



- by releasing the brake pedal

Active Brake Assist may cancel the brake application when one of the following conditions is fulfilled:

- You maneuver to avoid an obstacle.
- There is no longer a risk of collision.
- An obstacle is no longer detected in front of your vehicle.

#### Turning maneuver function (vehicles with Driving Assistance Package):

If the system detects a risk of a collision with oncoming vehicles or bicycles/motorcycles when turning across an oncoming lane, autonomous braking can be initiated at speeds below 9 mph (15 km/h) before you have left the lane in which you are driving.

#### Active Evasion Assist

##### **WARNING** Risk of accident despite Active Evasive Steering Assist

Active Evasive Steering Assist cannot always clearly identify objects and complex traffic situations.

In such cases, Active Evasive Steering Assist may:

- issue a warning or initiate a steering intervention without reason
- fail to issue a warning or initiate a steering intervention

Active Evasive Steering Assist can help to prevent a collision by automatically initiating a steering intervention.

- ▶ Always pay close attention to the road and traffic conditions and do not rely on Active Evasive Steering Assist alone.
- ▶ Be prepared to brake or swerve if necessary.

- ▶ Adjust your speed if there are pedestrians near the vehicle.

Active Evasion Assist can automatically react to stationary objects or objects moving in a longitudinal direction within the driver's own lane.

Active Evasion Assist has the following characteristics:

- Detection of pedestrians, cyclists and vehicles.
- Support by means of an autonomous steering intervention when an evasive maneuver is necessary
- Automatic activation when there is sufficient space within your lane
- Reaction from a speed of approximately 18 mph (30 km/h) up to a speed of approximately 50 mph (80 km/h).

In the event of an intervention by Active Evasion Assist, a warning tone will be emitted throughout the entire evasive maneuver and the distance warning lamp  will flash.

You can cancel support from Active Evasion Assist at any time by steering, accelerating or braking.

Active Evasion Assist may intervene in the following speed ranges:

- From a speed of approximately 18 mph (30 km/h) up to approximately 50 mph (80 km/h) when approaching stationary vehicles, pedestrians or cyclists
- From a speed of approximately 18 mph (30 km/h) up to approximately 50 mph (80 km/h) when approaching pedestrians walking in the direction of travel and cyclists in front

#### System limits

Full system performance is not yet available for a short time after switching on the vehicle or after driving off. Depending on the environmental conditions, it may take a few minutes before full system performance is available.

The system may be impaired or may not function, particularly in the following situations:

- In snow, rain, fog, heavy spray, direct sunlight or greatly varying ambient light, or if there is glare.
- If the sensors are dirty, fogged up, damaged or covered.
- If the sensors are impaired due to interference from other radar sources, e.g. strong radar reflections in parking garages.
- If a loss of tire pressure or a defective tire has been detected and displayed.
- In complex traffic situations where objects cannot always be clearly identified.
- If pedestrians or vehicles move quickly into the sensor detection range.
- If pedestrians are hidden by other objects.
- If the typical outline of a pedestrian cannot be distinguished from the background.
- If a pedestrian is not detected as such, e.g. due to special clothing or other objects.

- When lane markings are missing or hard to see.
- When the road's course is not more or less straight.
- On bends with a tight radius.
- If the driver's seat belt is not fastened.

#### Setting Active Brake Assist

##### Requirements

- The vehicle is switched on.

Multimedia system:

  **» Settings » Assistance**  
**» Collision Avoidance**

 Activate or deactivate the function.

 It is recommended that you always leave Active Brake Assist activated.

When Active Brake Assist is deactivated, the distance warning function, the collision warning, the autonomous braking function and Active Evasive Steering Assist (with Driving Assistance Package) will be deactivated.

- ❗ If Active Brake Assist is deactivated, the  symbol will appear on the status bar of the driver's display, and the system will be reactivated the next time the vehicle is started.

### Setting the timing of warnings

- ▶ Select  next to **Active Brake Assist**.
- ▶ Select **Early**, **Medium** or **Late**.

## Traffic Sign Assist

### Function of Traffic Sign Assist

- ❗ This function is an on-demand feature (→ page 21).

Traffic Sign Assist detects the traffic signs with the multifunction camera and compares them with the information on the digital road map of the navigation system. It assists you by displaying detected speed limits and overtaking restrictions on the driver's display. The maximum permissible speed can also be shown on the head-up display. The system can issue a warning when you exceed the maximum permissible speed.

In some countries, the system can provide you with further functions and can warn you when you are approaching pedestrian crossings. If the system detects that you are driving onto a section of road in the wrong direction of travel, it triggers a warning.

The camera can also detect and analyze traffic signs with a restriction indicated by an additional sign (e.g. when wet).

Traffic Sign Assist portrays only selected signs on the driver's display. Actual traffic signs and speed limits have priority over traffic signs and speed limits shown on the driver's display.

Also observe the following information:

- select a speed adapted to the traffic, surroundings and weather conditions
- observe actual traffic signs
- observe applicable traffic rules and regulations

Observe the notes on driving systems and your responsibility; you may otherwise fail to recognize dangers (→ page 167).

### Displays on the driver's display

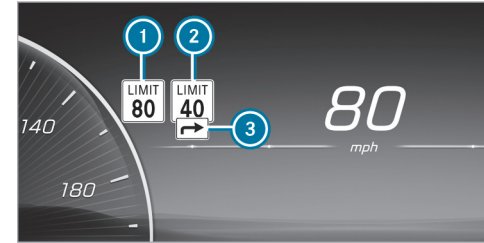

- ① Permissible speed
- ② Permissible speed when there is a restriction
- ③ Additional sign with restriction

The system can show up to two traffic signs on the driver's display simultaneously. The system always prioritizes displaying speed limits. No more than one traffic sign with a maximum permissible speed can be shown on the head-up display. If two speed signs are shown on the driver's display, e.g. when restrictions are detected, the value of left-hand speed limit ① is always transmitted to cruise control or Active Distance Assist

DISTRONIC for adoption and is shown on the head-up display.

Important information from other systems can lead to the traffic signs fading out for a short time.

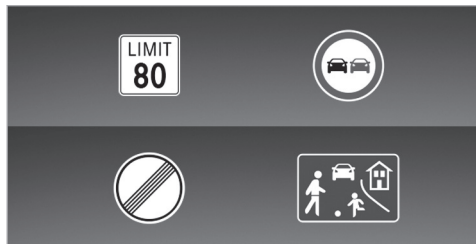

Examples of traffic signs that can be displayed

Traffic Sign Assist can detect and display the following traffic signs ①:

- speed limitations
- End of the speed limit
- overtaking restrictions
- Play streets

- Recommended speeds

Traffic Sign Assist can detect the following additional signs ③ and, if necessary, analyze the relevance of the restrictions using other vehicle sensors:

- When wet
- Slippery road surfaces
- In fog
- Temporary restrictions
- Exits
- Restrictions for car/trailer combinations

Traffic Sign Assist also uses data from the digital street map in the navigation system. When you leave or enter a municipality or change roads, on a highway on- or off-ramp, for example, or after you turn at an intersection, the display on the driver's display can thus be updated without a traffic sign having been detected.

- ① Regularly update the digital road map of the navigation system to enable Traffic Sign Assist to work optimally.

Depending on vehicle equipment and country, the system can also display speed restrictions ahead on the driver's display and on the head-up display. The driver's display can also show the distance to an upcoming lower limit speed. For this purpose, information from the digital road map of the navigation system is used. The Assistance menu can also display a dynamic visualization of the speed limits ahead.

If Traffic Sign Assist cannot determine the currently applicable maximum permissible speed (e.g. due to missing signs), the following display appears on the driver's display:



Traffic Sign Assist is not available in all countries. If the vehicle is in a country where Traffic Sign Assist is not supported, this is displayed continuously.

If Traffic Sign Assist is temporarily or permanently unavailable due to a technical fault or if the windshield is dirty, the Traffic Sign Assist warning lamp  will appear on the driver's display.

**i** Please also note the information on the Traffic Sign Assist display messages (→ page 358).

### Warning when the maximum permissible speed is exceeded

The system can warn you if you unintentionally exceed the maximum permissible speed. Depending on the country, you can set in the multimedia system by how much the maximum permitted speed may be exceeded before a warning is given. You can switch off the warning or set whether the warning should be visual (by flashing the traffic sign on the driver's display) or visual and audible. The selected setting is confirmed by an indication on the driver's display.

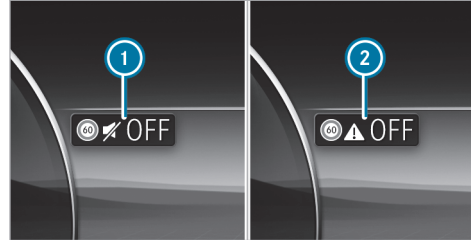

- 1** Warning only visual
- 2** Warning off

**i** The type, duration and deployment thresholds of the speed warning as well as the possibility of setting the deployment thresholds from which the warning is to be triggered are subject to the country-specific legislation of the country in which the vehicle is delivered.

### Additional functions of Traffic Sign Assist (country-specific)

**Warning for no-entry signs:** Traffic Sign Assist can warn you if you drive the wrong way down a sec-

tion of road, for example on highway on-ramps or one-way streets.

**Warning at pedestrian crossings:** if you approach pedestrian crossings, provided that pedestrians are in the danger zone or are moving towards it, Traffic Sign Assist can warn you up to a speed of approximately 44 mph (70 km/h).

### System limits

The system may be impaired or may not function particularly in the following situations:

- If visibility is poor, e.g. due to insufficient illumination of the road, highly variable shade conditions, rain, snow, fog, swirling dust or heavy spray.
- If there is glare, e.g. from oncoming traffic, direct sunlight or reflections.
- If there is dirt on the windshield in the vicinity of the multifunction camera or if the camera is fogged up, damaged or obscured.
- If the traffic signs are difficult to see because, for example, they are dirty, obscured, faded, iced over, damaged, inconveniently positioned, insufficiently illuminated or distorted.

- Active traffic signs with LED displays may not be detected correctly or at all due to technical factors, such as transmission frequency.
- If the information on the navigation system's digital map is incorrect, incomplete or out of date.
- If the signs, road markings or road layout are ambiguous, e.g. in the case of traffic signs in construction sites, at exits and driveways, in the case of adjacent lanes or parallel roads, in the case of pedestrian crossing markings at traffic lights
- If the signage or road markings do not comply with the standard
- If the signage, road markings or road guidance is country-specific and deviates from the route guidance of the navigation system, e.g. in or after road works
- After sharp turns and tight bends, when traffic signs are outside the camera's field of vision.
- If you overtake vehicles with traffic signs affixed or attached to them.

### Setting Traffic Sign Assist

Multimedia system:



 » Settings » Assistance  
 » Assistance » Traffic Sign Assist

### Activating or deactivating the speed warning

- ▶ Switch off [Speed Limit Warning](#).  
The speed warning remains off according to country-specific legislation until the next time the vehicle is switched on or off.

### Change the type of speed warning

- ▶ Change the warning to [Visual](#) or [Visual & Audible](#).

### Setting the warning threshold

This value determines the speed at which a warning is issued when exceeded.

- ▶ Set the desired speed under Warning Threshold.

### Traffic light view

#### Information about the traffic light view

The traffic light view supports the driver when waiting in front of a red light by displaying the camera image on the central display. The camera image is displayed when the driver is the first vehicle in front of the red light and faded out when the vehicle drives off.

#### Displaying traffic light view

##### Requirements:

- The [Traffic Light View](#) option is switched on .
- A traffic light view is available.



Multimedia system:



 » Settings » Assistance  
 » Assistance » Traffic Light View

 This function is not available in all countries. If the vehicle is in first position at a traffic light, the camera image with traffic light view is shown on the central display.

When the vehicle pulls away, the camera image is faded out.

- ▶ Activate  or deactivate  **Traffic Light View**.

#### Using other available functions

- ▶ Select .
- ▶ Select **On Request** or **Automatic**.  
If **On Request** is set and a traffic light view is available, the **Tap Here for Traffic Light View** message is displayed. The camera image is shown after confirmation of the message.  
When **Automatic** is set, the camera image is automatically displayed when the traffic light view is available.

#### Blind Spot Assist

##### Function of Blind Spot Assist with exit warning

Blind Spot Assist uses two lateral, rear-facing radar sensors to monitor the area up to 130 ft (40 m) behind and 10 ft (3 m) next to your vehicle. If a vehicle is detected from a speed of approximately 8 mph (12 km/h) and this vehicle subsequently enters the monitoring range directly next

to your vehicle, the warning lamp in the outside mirror will light up red.

Status display in the driver's display

 **Gray:** the system is activated but not operational.

 **Green:** the system is activated and operational.

If a vehicle is detected close to your vehicle and you switch on the turn signal indicator in the corresponding direction, a double warning tone will sound and the red warning lamp in the outside mirror will flash. If the turn signal indicator remains switched on, all other detected vehicles will be indicated only by the flashing of the red warning lamp.

If you overtake a vehicle quickly, no warning is given.

**⚠ WARNING** Risk of accident despite Blind Spot Assist

Blind Spot Assist does not react to vehicles approaching and overtaking you at a greatly different speed.

Blind Spot Assist cannot warn drivers in this situation.

- ▶ Always pay careful attention to the traffic situation and maintain a safe distance at the side of the vehicle.

Observe the notes on driving systems and your responsibility; you may otherwise fail to recognize dangers (→ page 167).

#### Exit warning

The exit warning is an additional function of Blind Spot Assist and can warn vehicle occupants about approaching vehicles when leaving the vehicle when stationary.

**⚠ WARNING** Risk of accident despite exit warning

The exit warning neither reacts to stationary objects nor to persons or road users approaching you at a greatly differing speed.

The exit warning cannot warn drivers in these situations.

- ▶ Always pay particular attention to the traffic situation when opening the doors and make sure there is sufficient clearance.

If there is a vehicle in the monitoring range, this will be indicated in the outside mirror. If a vehicle occupant opens the door on the side with the warning, a warning tone will sound and the warning lamp in the outside mirror will start to flash.

This additional function is available only when Blind Spot Assist is active. When the exit warning is activated, it can warn vehicle occupants for up to three minutes after switching the vehicle off. The exit warning is no longer available once the warning lamp in the outside mirror flashes three times.

The exit warning is only an aid and not a substitute for the attention of vehicle occupants. The responsibility for opening and closing the doors and for leaving the vehicle remains with the vehicle occupants.

### System limits

Blind Spot Assist may be limited in the following situations in particular:

- if there is dirt on the sensors or the sensors are obscured
- in poor visibility, e.g. due to fog, heavy rain or snow
- if there are narrow vehicles, e.g. bicycles or motorbikes
- if the road has very wide or narrow lanes
- if vehicles are not driving in the middle of their lane

Warnings may be issued in error when driving close to crash barriers or similar continuous lane borders. Always make sure that there is sufficient distance to the side for other traffic or obstacles.

Warnings may be interrupted when you are driving alongside long vehicles, such as trucks, for a prolonged time.

Blind Spot Assist is not operational when reverse gear is engaged.

The exit warning may be limited in the following situations:

- when the sensors are covered by adjacent vehicles in narrow parking spaces
- when people approach the vehicle
- in the event of stationary or slowly moving objects

### ■ Activating/deactivating Blind Spot Assist

Multimedia system:

- ↳  ▶ Settings ▶ Assistance
- ▶ Collision Avoidance
- ▶ Switch **Blind Spot Assist** on or off.

### Active Lane Keeping Assist

#### ■ Function of Active Lane Keeping Assist

Active Lane Keeping Assist monitors the area in front of your vehicle by means of the multifunction camera (→ page 167) and can warn you before you leave your lane unintentionally. The system can guide you back into your lane by means of a lane-correcting steering intervention and will also



issue a warning via haptic feedback through the steering wheel.

Active Lane Keeping Assist is available in the speed range between approximately 37 mph (60 km/h) and 124 mph (200 km/h).

The system may intervene in the following situations:

- Active Lane Keeping Assist detects a lane marking.
- One of your front wheels goes over this lane marking.

If you activate the turn signal indicator, no steering intervention will occur on the corresponding side.

If you leave the lane without activating the turn signal indicator, but danger of a collision with a moving obstacle in your lane is detected, no steering intervention will occur.

**Vehicles with Blind Spot Assist or Driving Assistance Package:** if the system detects an obstacle (e.g. another vehicle) in the adjacent lane, a steering intervention will occur regardless of the turn signal indicator.



Display ❶ will appear on the driver's display and a warning tone will sound in the following situations:

- A steering intervention by Active Lane Keeping Assist lasts longer than approximately ten seconds.
- The system carries out two or more steering interventions within approximately three minutes without any steering intervention from the driver.

In the Active Lane Keeping Assist settings, you can set the sensitivity of the system and the level of support. Additionally, you can set whether the

system should react to broken lane markings or only continuous lane markings (→ page 201).

#### Status displays for Active Lane Keeping Assist

 **White:** Active Lane Keeping Assist is deactivated.

If ESP<sup>®</sup> is deactivated or a tire pressure loss warning is displayed, Active Lane Keeping Assist will automatically be deactivated.

 **Yellow:** there is a malfunction. Please also observe the display messages.

 **Gray:** Active Lane Keeping Assist is activated, but not operating.

 **Green:** Active Lane Keeping Assist is activated and operating.

 **Red:** Active Lane Keeping Assist has guided you back into your lane with a lane-correcting steering intervention. The status display will flash if there is also a haptic warning via the steering wheel. The lane marking will be shown in red only on the side for which there is a warning.



Display on the driver's display in the [Assistance](#) menu

If the front wheel of the vehicle drives over a detected lane marking, this will be highlighted in red on the driver's display in the [Assistance](#) menu.

### System limits

In the following situations, a lane-correcting steering intervention may not occur but rather a warning may be given via the steering wheel, depending on the situation:

- If you clearly and actively steer, brake or accelerate.

- If a driving safety system intervenes, e.g. ESP® or Active Brake Assist.
- If you have adopted a sporty driving style with high cornering speeds or high rates of acceleration.

The system may be impaired or may not function, particularly in the following situations:

- If visibility is poor, e.g. due to insufficient illumination of the road, highly variable shade conditions, rain, snow, fog or heavy spray.
- If there is glare, e.g. from oncoming traffic, the sun or reflections.
- If there is dirt on the windshield in the vicinity of the multifunction camera or if the camera is fogged up, damaged or obscured.
- If there is dirt on the bumper in the area of the radar sensors, or if they are damaged or obscured.
- If there are no lane markings, or several unclear lane markings are present for one lane, e.g. around roadworks.
- If the lane markings are worn, dark or covered.

- If the distance to the vehicle in front is too short and thus the lane markings cannot be detected.
- If the lane markings change quickly, e.g. lanes branch off, cross one another or merge.
- If the road is very narrow and winding.

Observe the notes on driving systems and your responsibility; you may otherwise fail to recognize dangers (→ page 167).

### ■ Activating/deactivating Active Lane Keeping Assist

Multimedia system:

- ➔ ➔ [Settings](#) ➔ [Assistance](#)
- ➔ [Collision Avoidance](#)
- ➔ [Active Lane Keeping Assist](#)
- ▶ Activate or deactivate the function.

Alternatively, Active Lane Keeping Assist can be activated and deactivated via the quick vehicle access.

- ⓘ The settings after engine start are country-specific.

## ■ Setting Active Lane Keeping Assist

Multimedia system:

-  → Settings → Assistance
- Collision Avoidance
- Active Lane Keeping Assist

### Setting the sensitivity

- ▶ Select .
- ▶ Select **Early**, **Med.** or **Late**.

The last selected setting will be adopted the next time the vehicle is started.

- ⓘ The standard setting of this function is country-dependent.

### Activating or deactivating assistance on dashed lane markings

- ▶ Select **Advanced Support**.

The last selected setting will be adopted the next time the vehicle is started.

- ⓘ The standard setting of this function is country-dependent.

- ⓘ This function must be activated for Emergency Stop Assist to be fully available. Further information on Emergency Stop Assist (→ page 187)

### Function of adaptive damping adjustment

Suspension with adaptive damping adjustment continuously adjusts the characteristics of the suspension dampers to the current operating and driving conditions.

The damping is set individually for each wheel and is affected by the following factors:

- the road surface conditions
- vehicle load
- the drive program selected
- the driving style

The drive program can be set using DYNAMIC SELECT.

## Rear view camera

### ■ Function of the rear view camera

The rear view camera is only an aid. It is not a substitute for your attention to the surroundings. The responsibility for safe maneuvering and parking remains with you. Make sure that there are no persons, animals, objects, etc. in the maneuvering area while maneuvering and parking.

- ⓘ The area behind the vehicle is displayed as a mirror image, as in the inside rearview mirror.

### Vehicles without Parking Package

The following camera views are available on the central display:

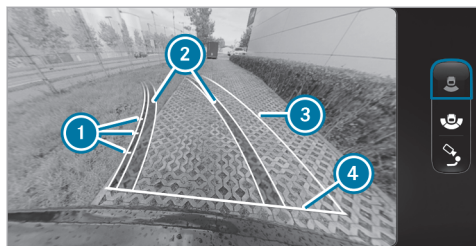

#### Standard view

- ① Guide lines at a distance of approximately 1.6 ft (0.5 m), 3.3 ft (1.0 m), 5 ft (1.5 m) and 9.9 ft (3.0 m) from the rear area
- ② Lane marking the course the tires will take with the current steering angle (dynamic)
- ③ Driven surface depending on the current steering angle (dynamic)
- ④ Guide line at a distance of approximately 1.0 ft (0.3 m) from the rear area



#### Wide-angle view

#### Pedestrian braking function

- ⓘ This function is available only in vehicles without the Parking Package. Vehicles with the Parking Package are equipped with maneuvering assistant functions (→ page 217).

The pedestrian braking function can prevent collisions with pedestrians when the vehicle is backing up at slow speeds. If the rear view camera detects a person in the vehicle path, the vehicle can be braked to a standstill.

The pedestrian braking function can intervene under the following conditions:

- The vehicle is backing up at a speed below 9 mph (15 km/h).
- The camera image is shown on the central display.

If automatic braking is triggered, the  symbol will appear in red in the camera image.

The  **Pedestrian! For Emerg. Braking Off: Tap Here** message will also appear.

The driver can close or ignore this message. The pedestrian braking function will then remain active. If the driver taps the message, the pedestrian braking function will briefly be deactivated.

The pedestrian braking function will be activated again in the following cases:

- The vehicle is driving forwards at a speed above 10 mph (16 km/h).
  - The vehicle is switched off and back on again.
- ⓘ If the function is not available or is deactivated, the  symbol will appear in gray in the camera image.

The pedestrian braking function is only an aid. It is not a substitute for your attention to the surroundings. The responsibility for safe maneuvering and parking remains with you. Make sure that no persons, animals, objects, etc. are in the maneuvering range.

**⚠ WARNING** Risk of accident caused by limited detection of the pedestrian braking function

The pedestrian braking function cannot always clearly detect people. Other obstacles are not detected by the function.

In these cases, the function may brake unnecessarily or not brake at all.

- ▶ Always pay careful attention to the traffic situation; do not rely on the pedestrian braking function alone.
- ▶ Be ready to brake.

In the following situations, the pedestrian braking function is not available:

- On inclines
- If the rear view camera is not operational

Be aware of the system limitations of the rear view camera.

### Vehicles with Parking Package

The following camera views are available on the central display:

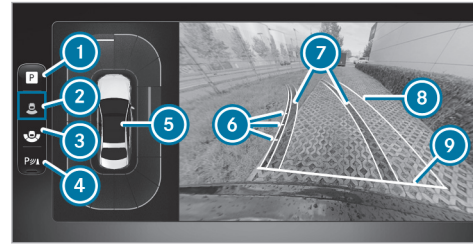

Camera Views menu on the 11.9" central display (top view)

- ① Menu **Parking Assistance**
- ② Rear-view camera with top view
- ③ Wide-angle view
- ④ Activating/deactivating Parking Assist PARKTRONIC (→ page 211)

- ⑤ Warning display of Parking Assist PARKTRONIC (→ page 208)
  - ⑥ Guide lines at a distance of approximately 1.6 ft (0.5 m), 3.3 ft (1.0 m), 5 ft (1.5 m) and 9.9 ft (3.0 m) from the rear area
  - ⑦ Lane marking the course the tires will take with the current steering angle (dynamic)
  - ⑧ Driven surface depending on the current steering angle (dynamic)
  - ⑨ Guide line at a distance of approximately 1.0 ft (0.3 m) from the rear area
- ⓘ When Active Parking Assist is active, the lanes ⑦ are displayed in green (→ page 212).

### System limits

If the system is not ready for operation, the **System Inoperative** message will appear on the central display.

The rear view camera will not function or will function only partially in the following situations:

- You are driving forwards at a speed greater than approximately 10 mph (16 km/h).
- The trunk lid is open.

- The weather conditions are poor, e.g. heavy rain, snow, fog, storm or spray.
  - The ambient light is poor (e.g. at night or if light is shining into the camera).
  - The camera lens is obstructed, dirty or fogged up. Observe the notes on cleaning the rear view camera (→ page 286).
  - The camera or rear of your vehicle is damaged. In this case, have the camera and its position and setting checked at a qualified specialist workshop.
- i** Do not use the rear view camera in these types of situations. You could otherwise injure others or collide with objects when parking the vehicle.

The field of vision and other functions of the camera system may be restricted due to additional attachments on the vehicle (e.g. license plate bracket or bicycle rack).

- i** The contrast of the display may be impaired by direct sunlight or by other light sources, e.g. when driving out of a garage. In this case, pay particular attention.

- i** Have the display repaired or replaced if, for example, pixel errors considerably restrict its use.

Also observe the information on vehicle sensors and cameras (→ page 167).

### 360° camera

#### Function of the 360° Camera

The 360° Camera is a system that consists of four cameras which cover the immediate surroundings of the vehicle. The cameras assist you when you are parking, for example, or at exits with reduced visibility.

The 360° camera includes the following cameras and evaluates their images:

- Rear view camera
- Front camera
- Two outside mirror cameras

The cameras are only an aid and may show a distorted view of obstacles, show them incorrectly or not show them at all. They are not a substitute for your attention to the surroundings. The responsi-

bility for safe maneuvering and parking remains with you. Make sure that there are no persons, animals, objects, etc. in the maneuvering area while maneuvering and parking.

The following camera views are available on the central display:



#### Camera Views menu overview

- 1 Menu **Parking Assistance**
- 2 Top view with image from the front camera
- 3 Panorama view
- 4 Top view with image from the rear view camera
- 5 3D view, left-hand side of the vehicle

- ⑥ 3D view, right-hand side of the vehicle
- ⑦ 3D auto view
- ⑧ Trailer view (equipment-dependent)
- ⑨ Activating/deactivating Parking Assist PARKTRONIC (→ page 211)
- ⑩ To set the GPS activation point
- ⓘ In all views, the Parking Assist PARKTRONIC warning display is shown (→ page 208).

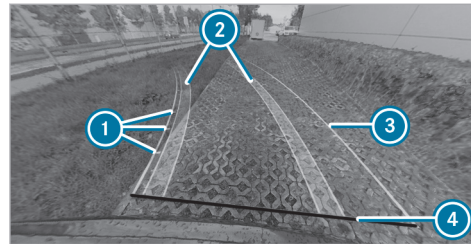

#### Function of the guide lines

- ① Guide lines at a distance of approximately 1.6 ft (0.5 m), 3.3 ft (1.0 m), 5 ft (1.5 m) and 9.9 ft (3.0 m) from the rear area
- ② Lane marking the course the tires will take with the current steering angle (dynamic)
- ③ Driven surface depending on the current steering angle (dynamic)
- ④ Guide line at a distance of approximately 1.0 ft (0.3 m) from the rear area
- ⓘ When Active Parking Assist is active, lanes and guide lines are displayed in green instead of yellow (→ page 212).

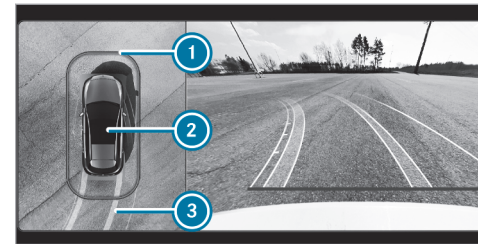

#### Top view with image from the front or rear view camera

- ① Warning display of Parking Assist PARKTRONIC (→ page 208)
- ② Your vehicle from above
- ③ Lane indicating the route the vehicle will take at the current steering angle

**⚠ WARNING** Risk of accidents due to objects not being displayed or being displayed in a distorted manner

Due to the projection of the cameras, objects in the 3D views may be strongly distorted or not displayed at all.

- ▶ Make sure that there are no persons, animals or objects etc., in the maneuvering area while maneuvering and parking.

**!** **NOTE** Risk of accident due to objects being severely distorted in the display or not displayed at all

Due to the projection of the cameras, objects in the 3D views may be severely distorted when displayed or not displayed at all.

- ▶ Make sure that there are no persons, animals or objects etc. in the maneuvering area while maneuvering and parking.



3D view, left/right-hand side of the vehicle

In the 3D view, left/right-hand side of the vehicle, the virtual camera moves to respective side of the vehicle ②. When you change the transmission position, the view is automatically adapted. In addition, top view ① will be displayed with the Parking Assist PARKTRONIC warning display.

- ① The area behind the vehicle is **not** displayed as a mirror image as is usual in the 3D views.

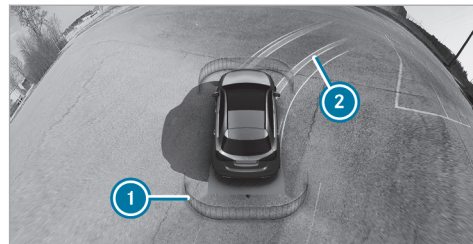

3D auto view

- ① Display of Parking Assist PARKTRONIC (→ page 208)
- ② Guide lines

In the 3D auto view, the virtual camera moves to the standard perspective, facing forward from the rear above the roof. The view changes automatically when approaching obstacles.

If you touch the touchscreen, the view changes to the 3D view with free rotation. You can turn, tilt and zoom the views by touch.





#### Wide-angle view

- ① Display of Parking Assist PARKTRONIC (→ page 208)
- ② Top view with image from the rear view camera
- ③ Wide-angle view

If the top view with image from the rear view camera is displayed, switch to the wide-angle view with icon ② indented to the left. When the wide-angle view is displayed, switch back to the respective top view.

#### System limits

If the system is not ready for operation, the **System Inoperative** message will appear on the central display.

**⚠ WARNING** Risk of accident due to restrictions in the function of the 360° camera

If the function of the 360° camera is restricted, there is a risk of collision with people or objects.

- ▶ Do not use the 360° camera in the event of function restrictions.
- ▶ Make sure that there are no persons, animals or objects etc., in the maneuvering area while maneuvering and parking.

The 360° Camera will not function or will only partially function in the following situations:

- You are driving forwards at a speed greater than approximately 10 mph (16 km/h).
- The doors are open.
- An outside mirror is not completely folded out.
- The trunk lid is open.

- The weather conditions are poor, e.g. heavy rain, snow, fog, storm or spray.
- The ambient light is poor (e.g. at night or if light is shining into the camera).
- The camera lens is obstructed, dirty or fogged up. See the notes on cleaning the 360° Camera (→ page 286).
- If cameras or vehicle components in which the cameras are installed are damaged. In this event, have the cameras, their positions and their setting checked at a qualified specialist workshop.

For technical reasons, the standard height of the vehicle may be altered if the vehicle is carrying a heavy load and can result in inaccuracies in the guide lines and in the display of the generated images.

The field of vision and other functions of the camera system may be restricted due to additional attachments on the vehicle (e.g. license plate bracket or bicycle rack).

- ❗ The contrast of the display may be impaired by abrupt, direct sunlight or by other light sources, e.g. when you are driving out of a garage. In this case, pay particular attention.
- ❗ Have the display repaired or replaced if, for example, pixel errors considerably restrict its use.

Also observe the information on vehicle sensors and cameras (→ page 167).

### ■ Calling up the 360° camera views using the button

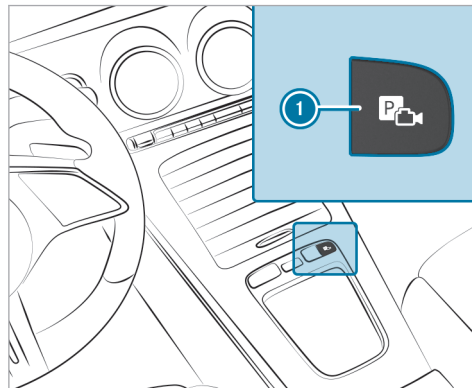

- ▶ Press button ❶.
- ▶ Select **Camera Views** menu.
- ▶ Select the desired view in the multimedia system (→ page 204).

### ■ Selecting a view for the 360° camera (reverse gear)

- ▶ Engage reverse gear.
- ▶ Select the desired view in the multimedia system (→ page 204).

### ■ Opening the camera cover

Multimedia system:

- ▶ Home ▶ Settings ▶ Assistance ▶ Camera

- ▶ Select **Open Camera Cover**.

- ❗ The camera cover closes automatically after some time or after the vehicle is switched on or off.

### Parking Assist PARKTRONIC

#### ■ Function of Parking Assist PARKTRONIC

Parking Assist PARKTRONIC is an electronic parking assistance system that monitors the area surrounding your vehicle and shows you the distance between the vehicle and a detected obstacle visually and audibly.

The passive side impact protection also warns you of obstacles to the side. These must be detected beforehand by the sensors in the front or rear bumper while you are driving by them. If you steer in the direction of a detected obstacle and there is a risk of a lateral collision, a warning is issued.

The passive side impact protection can be activated and deactivated via the multimedia system (→ page 212).

In order for front or rear obstacles to the side to be displayed, the vehicle must first travel a distance of at least half a vehicle length. Once the vehicle has traveled one vehicle length, obstacles on all sides can be shown.

Parking Assist PARKTRONIC is only an aid. It is not a substitute for your attention to the surroundings. The responsibility for safe maneuvering and parking remains with you. Make sure that there are no persons, animals or objects in the maneuvering area while maneuvering and parking in/ exiting parking spaces.

### Displays in the central display

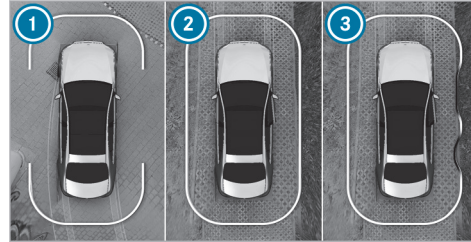

Vehicles with 360° camera

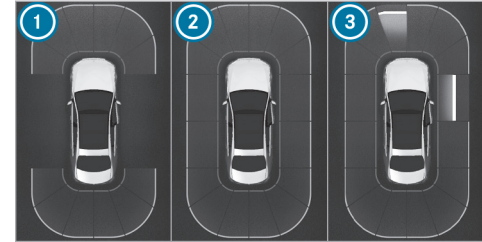

Vehicles with rear-view camera

- ① Front and rear ready for display
- ② All sides ready for display
- ③ All sides ready for display and obstacle detected

As soon as Parking Assist PARKTRONIC is ready for display, the respective areas ① to ③ of the display are shown in blue.

The color of the display changes depending on the distance to the detected obstacle:

- **Blue:** > 3.3 ft (1 m) (no obstacles detected)
- **Yellow:** approximately 3.3 ft (1 m) - 2.3 ft (0.7 m)

## 210 Driving and parking

- **Orange:** approximately 2.3 ft (0.7 m) - 1.3 ft (0.4 m)
- **Red:** <1.3 ft (0.4 m)

**Vehicles with 360° camera:** the boundary line shifts dynamically depending on the position and distance of the obstacles detected.

Depending on the distance to the obstacle detected, an intermittent warning tone also sounds. You can set the timing of the warnings in the multimedia system. In the **Warn Early** setting, the system warns you from a distance of 3.3 ft (1 m), in the standard setting only from 1.3 ft (0.4 m).



Vehicles with 360° camera

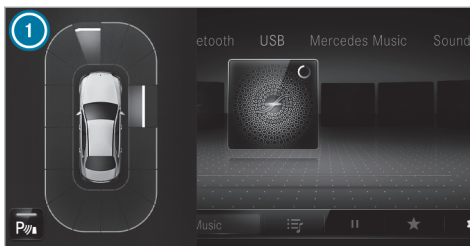

Vehicles with rear-view camera

If you are not in the **Camera & Parking** menu and an obstacle in the vehicle path is detected, pop-up window **1** appears on the central display if the following requirements are met:

- **Vehicles without Active Parking Assist:** when driving no faster than 8 mph (12 km/h).
- **Vehicles with Active Parking Assist:** when driving no faster than 11 mph (18 km/h).

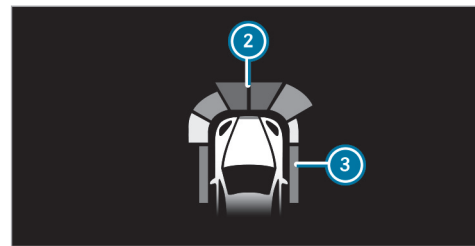

Optionally, obstacles detected by Parking Assist PARKTRONIC from a distance of approximately 3.3 ft (1.0 m) in front **2** and 2.3 ft (0.7 m) on the sides **3** can also be displayed on the head-up display.

### System limits

Parking Assist PARKTRONIC does not necessarily take into account the following obstacles:

- Obstacles below the detection area, e.g. persons, animals or objects.
- Obstacles above the detection area, e.g. projecting loads, overhangs or loading ramps on trucks.

- Pedestrians or animals approaching the vehicle from the side.
- Objects placed next to the vehicle

Obstacles on the sides are not shown in the following situations, for example:

- You park the vehicle and switch it off.
- You open the doors.

After the engine is restarted, obstacles must be detected again by driving past them before a new warning can be issued.

Also observe the system limits of the following systems:

- Rear-view camera (→ page 201)
- 360° camera (→ page 204)

Observe the information on vehicle sensors and cameras; otherwise the system cannot function properly (→ page 167).

### Problems with Parking Assist PARKTRONIC

If the Parking Assist PARKTRONIC display lights up red for approximately three seconds then goes out, and the  symbol appears on the driver's

display, the system may have been deactivated due to signal interference. Start the vehicle again and check if Parking Assist PARKTRONIC is working at a different location.

If a warning tone also sounds, it may be due to one of the following causes:

- **The sensors are dirty:** clean the sensors (→ page 286).
- **Parking Assist PARKTRONIC has been deactivated due to a malfunction:** restart the vehicle. If the problem persists, consult a qualified specialist workshop.

### Activating/deactivating Parking Assist PARKTRONIC

 **NOTE** Vehicle damage during parking or maneuvering due to objects at close range

Parking Assist PARKTRONIC may not detect certain objects close to the vehicle.

- ▶ When parking or maneuvering, look out in particular for objects that are underneath or above the sensors, e.g. flower

pots or drawbars. Otherwise, the vehicle or other objects could be damaged.

### Requirements

- The camera menu is open.
- Or: the PARKTRONIC pop-up window appears.

▶ Tap  on the central display.

If the indicator lamp is lit, Parking Assist PARKTRONIC is active. If the indicator lamp does not light up or the symbol  is displayed, Parking Assist PARKTRONIC is not active.

 Parking Assist PARKTRONIC is automatically activated when the vehicle is started.

Alternatively, Parking Assist PARKTRONIC can be activated or deactivated in the quick access menu.

### ■ Setting the warning tones of Parking Assist PARKTRONIC

Multimedia system:

-  ▶ Settings ▶ Assistance
- ▶ Parking ▶ PARKTRONIC

#### Adjusting warning tones

- ▶ Select **Set Warning Tones**.
- ▶ Set the desired level under **Volume** or **Tone Pitch**.

#### Activating/deactivating audio fadeout

- ▶ **Audio Fadeout** select and **Audio Fade for Warnings** switch on or off.

The volume of the currently playing media source is reduced during a Parking Assist PARKTRONIC warning tone.

or

- ▶ **Audio Fadeout** select and **Audio Fadeout When in R** switch on or off.

The volume of the currently playing media source is reduced when reverse gear is engaged.

#### Setting the time of the warnings

- ▶ Select **Time of Warning**.
- ▶ Set the desired warning time for **Front** or **Rear**.
- ▶ Switch **Side Warning** on or off.

#### Active Parking Assist

##### ■ Function of Active Parking Assist

Active Parking Assist is an electronic parking assistance system that uses ultrasound with the assistance of the rear-view camera and 360° Camera. When you are driving forwards up to approximately 22 mph (35 km/h), the system automatically measures parking spaces on both sides of the vehicle.

Active Parking Assist is only an aid. It is not a substitute for your attention to the surroundings. The responsibility for safe maneuvering and parking remains with you. Make sure that no persons, animals, objects, etc. are in the maneuvering range.

Active Parking Assist offers the following functions:

Vehicles with rear-view camera



- Parking in parking spaces parallel to the road
- Backing up into parking spaces perpendicular to the road

The parking space can be freely selected. The vehicle will be parked in reverse.

Vehicles with 360° Camera

- Parking in parking spaces parallel to the road
- Parking in parking spaces perpendicular to the road (optionally either forwards or in reverse)
- Parking in parking spaces that can be detected as such only due to markings (e.g. at the roadside)
- Exiting parking spaces if you have parked using Active Parking Assist

The parking space can be freely selected. Depending on the location of the parking space, the parking direction (forwards or in reverse) can also be selected as desired.

If Active Parking Assist is available, the  message will appear on the driver's display. When the system detects parking spaces,  will appear.

The arrows show on which side of the road free parking spaces are located. These will then be shown on the central display.

When Active Parking Assist is activated, the turn signals will be activated based on the calculated path of your vehicle. When you are entering or exiting a parking space, the procedure will be assisted by acceleration, braking, steering and gear changes.

To start the parking procedure, press the  button (→ page 214).

Active Parking Assist will be canceled in the following situations:

- You press the  button again.
- You begin steering.
- You engage park position **P**.
- You apply the electric parking brake.
- ESP<sup>®</sup> intervenes.
- You open the driver's door.

### System limits

Active Parking Assist will not be available if the exterior lighting is malfunctioning.

Objects that are above or below the detection range of Active Parking Assist (e.g. protruding loads, overhangs or loading ramps of trucks or boundaries of parking spaces) will not be detected when the parking space is measured. These will also then not be taken into account when the parking procedure is calculated. In some circumstances, Active Parking Assist may therefore guide you into the parking space prematurely or brake too late.

Certain environmental conditions (e.g. snowfall or heavy rain) may lead to a parking space being measured inaccurately. Parking spaces that are partially occupied by trailer drawbars might not be identified as such or be measured incorrectly. Only use Active Parking Assist on level, high-grip ground.

**⚠ WARNING** Risk of accident due to objects located above or below the detection range of Active Parking Assist

If there are objects above or below the detection range, the following situations may arise:

- Active Parking Assist may steer too early.
- The vehicle may not stop in front of these objects.

There is a danger of collision!

 In these situations, do not use Active Parking Assist.

Active Parking Assist can also display unsuitable parking spaces (e.g. parking spaces in which parking is not permitted or parking spaces on unsuitable surfaces).

Do not use Active Parking Assist in the following situations:

- In extreme weather conditions such as ice, packed snow or in heavy rain.
- When transporting a load that protrudes beyond the vehicle.

- If the parking space is on a steep downhill or uphill gradient.
- When snow chains are installed.
- Directly after a tire change or when spare tires are installed.
- If the tire pressure is too low or too high.
- On steep inclines of more than approximately 15%.

### ■ Parking with Active Parking Assist

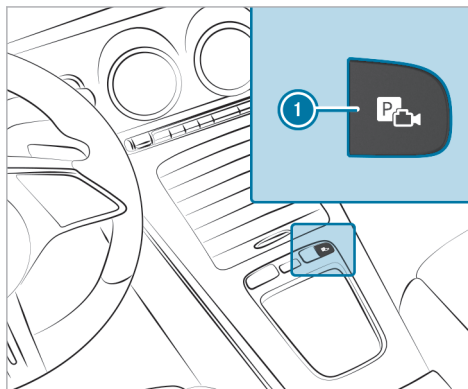

▶ Press button ①.

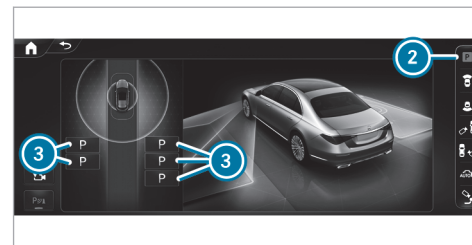

Parking assistance menu (example)

▶ Select the ② Parking Assistance menu.

Parking spaces ③ detected by the system will be shown on the central display.





Parking assistance menu (example)

When the vehicle is stationary, indicated vehicle path ④ into currently selected parking space ⑤ will also appear.

- ▶ If a parking space is displayed: stop the vehicle.
- ▶ If necessary, select another parking space.
- ▶ **Vehicles with 360° camera:** to change the parking direction, tap the selected parking space again.
- ▶ **To start the parking procedure:** press button ① again.

- ▶ Take your hands off the steering wheel. The vehicle will drive into the selected parking space.

The turn signal indicator will be switched on automatically when the parking procedure begins. You are responsible for selecting the turn signal indicator in accordance with the traffic conditions. If necessary, select the turn signal indicator accordingly.

**⚠ WARNING** Risk of accident due to vehicle swinging out while parking or pulling out of a parking space

While parking or exiting a parking space, the vehicle swings out and can drive onto areas of the oncoming lane.

This could cause you to collide with objects or other road users.

- ▶ Pay attention to objects and other road users.
- ▶ Where necessary, stop the vehicle or cancel the parking procedure with Active Parking Assist.

On completion of the parking procedure, a display message reading **Active Parking Assist Finished** will appear.

- ▶ Secure the vehicle against rolling away. When required by legal requirements or local conditions: turn the wheels towards the curb.
- ① You can stop the vehicle and change the transmission position during the parking procedure. The system will then calculate a new vehicle path. If no new vehicle path is available, the transmission position can be changed again or the process can be canceled.

### ▶ Exiting a parking space with Active Parking Assist

#### Requirements

- The vehicle is equipped with a 360° camera.
- The vehicle has been parked with Active Parking Assist.
- ▶ Start the vehicle.

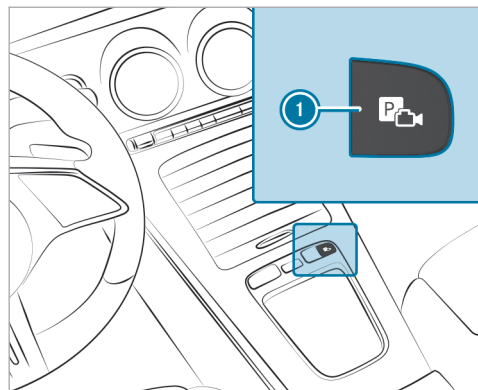

- ▶ Press button ①.



Parking assistance menu (example)

- ▶ Select the **Parking Assistance** ② menu.
- ▶ If necessary, change your direction of exit ③.
- ▶ **To start exiting the parking space:** press button ① again.
- ▶ If necessary, change the transmission position. Observe any messages displayed on the driver's display and central display. The vehicle will move out of the parking space.

The turn signal indicator will automatically be switched on when the process of exiting a parking space begins and switched off when it is completed. You are responsible for selecting the turn sig-

nal indicator in accordance with the traffic conditions. If necessary, select the turn signal indicator accordingly.

After the parking space has been exited, a warning tone and the  **Active Parking Assist Finished: Take Control of Vehicle** message will prompt you to take control of the vehicle. You will need to accelerate, brake, steer and change gear yourself again.

If you do not react to the prompt to take control of the vehicle, the system will apply the brakes to bring the vehicle to a standstill.

### ■ Pausing Active Parking Assist

You can interrupt the parking or exiting procedure of Active Parking Assist by performing one of the following actions, foreexample:

- ▶ Depress the brake pedal.
- ▶ Open the front passenger door, a rear door, the trunk or the hood.
- ▶ Apply the electric parking brake or activating the HOLD function.
- ▶ **To resume the parking or exiting procedure:** gently depress the accelerator pedal.

- ❗ If the electric parking brake was applied before Active Parking Assist was activated, depress the accelerator pedal lightly to start the parking or exiting procedure.

Check the area around your vehicle again before resuming a paused parking procedure. Check again that there are no persons, animals or objects in the maneuvering range. Also observe the system limitations of Active Parking Assist.

### ■ Automatic braking function of Active Parking Assist

Persons or objects detected in the maneuvering range could cause the vehicle to brake sharply and interrupt the parking or exiting procedure. The vehicle will then be held at a standstill. If you depress the accelerator pedal, the parking or exiting procedure is resumed.

Check the area around your vehicle again before resuming the parking or exiting procedure. Check again that there are no persons, animals or objects in the maneuvering range. Also observe the system limitations of Active Parking Assist.

## Maneuvering assistance

### ■ Function of Drive Away Assist

Drive Away Assist can reduce the severity of an impact when pulling away. If an obstacle is detected in the direction of travel, the vehicle's speed is briefly reduced to approx. 1 mph (2 km/h). If a critical situation is detected, the  symbol appears on the central display.

Drive Away Assist can be activated or deactivated in the [Maneuvering Assistance](#) menu.

- ❗ You can cancel an intervention by Drive Away Assist at any time by deactivating Parking Assist PARKTRONIC.

**⚠ WARNING** Risk of accident caused by limited detection performance of Drive Away Assist

Drive Away Assist cannot always clearly identify objects and traffic situations.

- ▶ Always pay careful attention to the traffic situation; do not rely on Drive Away Assist alone.

- ▶ Be prepared to brake or swerve as necessary, provided the traffic situation permits and that it is safe to take evasive action.

Drive Away Assist is only an aid. It is not a substitute for your attention to the surroundings. The responsibility for safe maneuvering and parking remains with you. Make sure that no persons, animals or objects etc. are in the maneuvering range.

A risk of a collision may arise in the following situations, for example:

- If the driver mixes up the accelerator and brake pedals.
- If an incorrect transmission position is engaged.

The Drive Away Assist function is active under the following conditions:

- If Parking Assist PARKTRONIC is activated.
- If you shift the transmission position to **R** or **D** when the vehicle is stationary.

- If the detected obstacle is less than approx. 3.3 ft (1.0 m) away.
- The maneuvering assistant is activated (→ page 219).

### System limits

The performance of Drive Away Assist is limited on inclines.

- ① Also observe the system limits of Parking Assist PARKTRONIC (→ page 208).

### Function of Cross Traffic Alert

- ① Cross Traffic Alert is available only for vehicles with Blind Spot Assist.

Cross Traffic Alert can warn drivers of any crossing traffic when backing up out of a parking space and maneuvering. The radar sensors in the bumper also monitor the area adjacent to the vehicle. If a critical situation is detected, the  symbol appears on the central display and the vehicle can be braked automatically.

If the radar sensors are obstructed by vehicles or other objects, detection is not possible.

The Cross Traffic Alert function is active under the following conditions:

- If the vehicle is backing up at walking pace.
  - The maneuvering assistant is activated (→ page 219).
- ① Also observe the notes on Blind Spot Assist (→ page 197).

### System limits

The Cross Traffic Alert function is not available on inclines.

### Function of close-range braking

The close-range braking function can prevent collisions with pedestrians when the vehicle is backing up at slow speeds. If the rear-view camera detects a person in the vehicle's path, the brakes can be applied to bring the vehicle to a standstill.

The close-range braking function may intervene in the following circumstances:

- The vehicle is backing up at a speed slower than 6 mph (10 km/h).
- The camera image is shown on the central display (→ page 208).

Close-range braking can be deactivated or activated on the **Maneuvering Assistance** menu (depending on the country) (→ page 219).

If the close-range braking function is triggered, the  symbol will appear in red in the selected view on the **Camera & Parking** menu.

- ① If close-range braking is not available, the  symbol will appear in gray.

The close-range braking function is only an aid. It is not a substitute for your attention to the surroundings. The responsibility for safe maneuvering and parking remains with you. Make sure that no persons, animals, objects, etc. are in the maneuvering range.

**⚠ WARNING** Risk of accident caused by limited detection by the maneuvering brake function

The maneuvering brake function cannot always clearly detect people. Other obstacles are not detected by the function.

In these cases, the function may brake unnecessarily or not brake at all.

- ▶ Always pay careful attention to the traffic situation; do not rely on the maneuvering brake function alone.
- ▶ Be ready to brake.

### System limits

Observe the system limits of the following functions:

- Active Parking Assist (→ page 212)
- 360° camera (→ page 204)
- Rear-view camera (→ page 201)

The close-range braking function will not be available in the following situations:

- On inclines

### ■ Activating/deactivating maneuvering assistant

Multimedia system:

→  ▶ Settings ▶ Assistance  
▶ Parking

- ⓘ This function is an on-demand feature (→ page 21).

- ⓘ Activating/deactivating the maneuvering assistant function is not available in all countries.

- ▶ Select **Maneuvering Assistance**.
- ▶ Activate or deactivate the desired maneuvering assistant.

### Vehicle towing instructions

The vehicle is not suitable for the use of tow bar systems that are used for flat towing or dinghy towing, for example. Attaching and using tow bar systems can result in damage to the vehicle.

When you are towing a vehicle with tow bar systems, safe driving characteristics cannot be guaranteed for the towing vehicle or the towed vehicle. The vehicle-trailer combination may swerve from side to side.

Observe the following information:

- Permitted towing methods (→ page 305)
- The notes on towing with both axles on the ground (→ page 306)

### Notes on the driver's display

**⚠ WARNING** Risk of accident if the driver's display fails

If the driver's display fails or malfunctions, you may not be aware of any functional limitations to safety-critical systems. This may affect the operating safety of the vehicle.

- ▶ Park the vehicle safely as soon as possible and notify a qualified specialist workshop.

**! NOTE** Mercedes-AMG vehicles

- ▶ Observe the notes in the Supplement. You could otherwise fail to recognize dangers.

If the operating safety of your vehicle is impaired, park the vehicle immediately and safely. Contact a qualified specialist workshop.

The driver's display shows the following basic information:

- Speed and engine speed

- Fuel level and coolant temperature
- Indicator and warning lamps

Additional functions available include the following:

- Different menus, e.g. for assistance and navigation
- Status displays for the driving systems
- Display messages
- Information on speed, **Consumption** and range

Some menu content and settings can be customized.

### Operating the driver's display

**⚠ WARNING** Risk of distraction from information systems and communications equipment

If you operate information systems and communication devices integrated in the vehicle when driving, you could be distracted from the

traffic situation. This could also cause you to lose control of the vehicle.

- ▶ Only operate this equipment when the traffic situation permits.
- ▶ If you cannot be sure of this, stop the vehicle whilst paying attention to road and traffic conditions and operate the equipment with the vehicle stationary.

Observe the legal requirements for the country in which you are currently driving when operating the driver's display.

## Scrolling on the menu bar

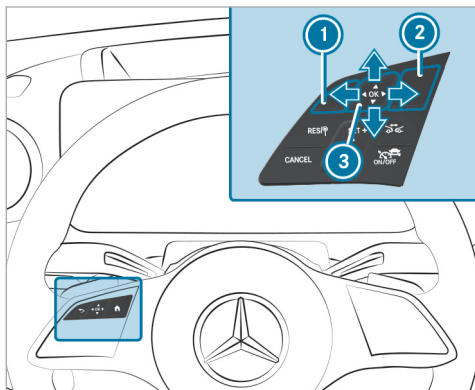

- ① Back button
- ② Main menu button
- ③ Touch Control

The content on the driver's display is controlled using the control elements on the left side of the steering wheel. You can use Touch Control ③ to navigate vertically and horizontally by swiping with

one finger. Confirm the selection by pressing the Touch Control.

- ① To operate Touch Control ③ in the most effective way, use the tip of your thumb if possible. You can also set the sensitivity of the Touch Control on the central display .
- ▶ Briefly press main menu button ② .
- ▶ Select a menu by swiping to the left or right on Touch Control ③ .
- ▶ **To confirm:** press Touch Control ③ .

### Driver display menus

#### Notes on menus on the driver's display

**⚠ WARNING** Risk of distraction from information systems and communications equipment

If you operate information systems and communication devices integrated in the vehicle when driving, you could be distracted from the traffic situation. This could also cause you to lose control of the vehicle.

- ▶ Only operate this equipment when the traffic situation permits.
- ▶ If you cannot be sure of this, stop the vehicle whilst paying attention to road and traffic conditions and operate the equipment with the vehicle stationary.

Observe the legal requirements for the country in which you are currently driving when operating the driver's display.

The following menu can be called up via the menu bar on the driver's display:

- Understated
- Sport
- Classic
- Navigation
- Assistance
- Service

On some of these menus, you can choose between different display content on the centre display area.

## 222 Driver's display

On most of the menus, you can use **Options** to configure further settings for the menu-specific display content.

You can find further information about the possible settings and selections on the menus in the Digital Operator's Manual.

### Calling up displays on the Sport menu

Driver display:



The **Sport** menu displays information about the engine data, the setup and the temperature of the vehicle.

▶ **To call up the menu:** swipe to the left or right on the left-hand Touch Control.

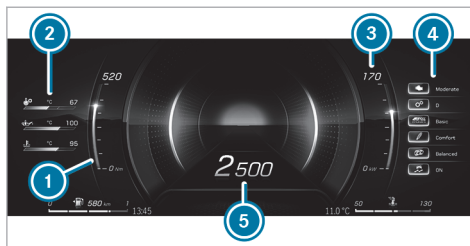

- ① Current torque
  - ② Temperature (transmission oil temperature, engine oil temperature, coolant temperature)
  - ③ Current power output
  - ④ Setup (drive position, transmission position, AMG DYNAMICS, suspension tuning, exhaust system, ESP®)
  - ⑤ engine speed
- i Depending on the vehicle equipment, AMG-specific content regarding temperature, setup and engine data will be displayed. The settings for the setup display content can be configured either via the buttons on the multi-function steering wheel or via the MBUX mul-

timedia system . You can also activate or deactivate ESP® using the steering-wheel button or via the MBUX multimedia system.

### Head-up Display

#### Function of the head-up display

The head-up display projects various content into the driver's field of vision, for example.

You can use the head-up display menu bar to select various contexts, e.g.:

- Minimal
- Sport
- Standard
- ECO display (depending on model and equipment) (→ page 145)
- Settings
- Head-up display on/off

The following image shows an example of the head-up display. You can choose what content is displayed (→ page 223).



## System limits

Visibility is particularly influenced by the following conditions:

- Seat position
- Image position setting
- Ambient light
- Wet road surfaces
- Objects on the display cover
- Polarization in sunglasses

## Operating the head-up display

### Selecting display content of the head-up display via the menu bar of the driver's display

- ▶ Press the main menu button  on the left.
- ▶ **To select the menu bar of the head-up display:** swipe upwards on the left-hand Touch Control.





### Switching between display content on the head-up display

- ▶ Swipe to the left or right on the left-hand Touch Control. A preview of the selected display content will appear on the head-up display.
- ▶ **To confirm:** press the  button.

### Switching back to the driver's display

- ▶ Press the  or  button.

## Setting the position and brightness

- ▶ Swipe to the left or right on the left-hand Touch Control and select **Settings** on the menu bar of the head-up display.
- ▶ Press the left-hand Touch Control. The current position and brightness settings will be displayed as graphics on the head-up display as well as on the driver's display.
- ▶ **To adjust the position:** swipe upwards or downwards on the left-hand Touch Control.
- ▶ **To adjust the brightness:** swipe to the left or right on the left-hand Touch Control. The settings configured for position and brightness will be saved automatically.
- ▶ Press the  or  button to exit the settings.

### Switching the head-up display on/off

Driver's display:



#### Switching on

- ▶ Swipe upwards on left-hand Touch Control.
- ▶ Press left-hand Touch Control **OK**.

#### Switching off

- ▶ Swipe upwards on left-hand Touch Control.
- ▶ Swipe on the left-hand Touch Control and select **Head-up Display**.
- ▶ Press left-hand Touch Control **OK**.

### Vehicles with a 48 V on-board electrical system

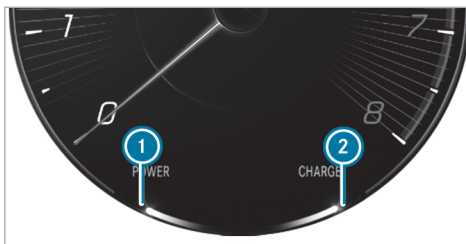

- ① Electric drive support
- ② Recuperation behaviour of the electric motor
- i Due to various system limits, the values displayed may temporarily differ slightly from the actual value.







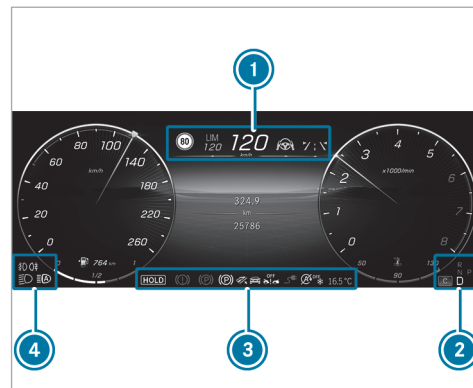









### Overview of status indicators on the driver display

The status indicators for the driving and driving safety systems can be found in display sections

① to ④.



- ⬇ Pedestrian detection (on assistant display only)
- P Active Parking Assist is available (→ page 214)
- P Active Parking Assist has detected a parking space (→ page 214)
- OFF Parking Assist PARKTRONIC deactivated (→ page 211)

-  Cruise control (→ page 176)
-  Active Distance Assist DISTRONIC (→ page 178)
-  Specified distance for Active Distance Assist DISTRONIC (→ page 178)
-  Active Brake Assist switched off (→ page 192)
-  Active Brake Assist impaired or not functioning (→ page 192)
-  Active Steering Assist (→ page 185)
-  Active Lane Keeping Assist (→ page 198)
-  Active Blind Spot Assist (on assistant display only)
-  Blind Spot Assist (on assistant display only)
-  Plug-in hybrid operation activated
-  Haptic accelerator pedal (→ page 146)
-  ECO start/stop function (→ page 144)
-  HOLD function (→ page 172)
-  Adaptive Highbeam Assist (→ page 123)
-  Active Stop-and-Go Assist
-  Slippery road surface warning

**Vehicles with Traffic Sign Assist:** detected instructions and traffic signs (→ page 193)

Important information from other driving systems may briefly appear in front of the displayed traffic signs.

## Overview and operation

### Notes on the MBUX multimedia system

**⚠ WARNING** Risk of distraction from information systems and communications equipment

If you operate information systems and communication devices integrated in the vehicle when driving, you could be distracted from the traffic situation. This could also cause you to lose control of the vehicle.

- ▶ Only operate this equipment when the traffic situation permits.
- ▶ If you cannot be sure of this, stop the vehicle whilst paying attention to road and traffic conditions and operate the equipment with the vehicle stationary.

You must observe the legal requirements for the country in which you are currently driving when operating the multimedia system.

Depending on the equipment, the scope of function and product designation of your MBUX multimedia system may differ from the description and

images in this Operator's Manual. For example, route guidance with augmented reality is not available in all equipment variants.

## Overview of the MBUX multimedia system

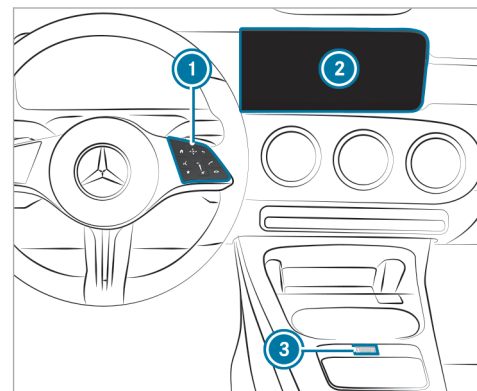

- ① Touch Control and control panel for the MBUX multimedia system  
MBUX stands for Mercedes-Benz User Experience.
  - Operating Touch Control
- ② Media display with touch functionality
  - Home screen overview

- Operating the touchscreen

### ③ Controller

Press and hold: switches the MBUX multimedia system or media display on or off  
 Press briefly: switches the mute function on/off

Turn: adjusts the volume

Further operating options:

- Conducting a dialog with the MBUX Voice Assistant.
  - Operating functions contact-free with the MBUX Interior Assistant.
- ① You can find further information about operation as well as about applications and services in the Digital Operator's Manual.

### Anti-theft protection

This device is equipped with technical provisions to protect it against theft. Further information on anti-theft protection can be obtained at an authorized Mercedes-Benz Center.

### Home screen overview

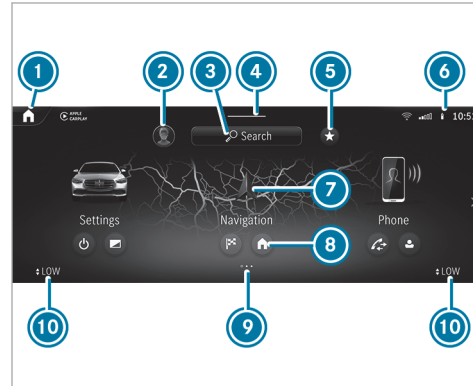

- ① On the home screen: displays the first three applications  
 In other displays: calls up the home screen
- ② Calls up user profile settings and switches user
- ③ Uses the global search
- ④ Calls up the Control Center: pull the bar down

- ⑤ Calls up favorites
- ⑥ Displays in the status line
- ⑦ Calls up applications
- ⑧ Quick-access to application
- ⑨ Index points for selected display area
- ⑩ Calls up the air conditioning menu

The following functions are called up in the Control Center:

- Notifications Center
- Favorites
- Vehicle quick-access

## Operating the MBUX multimedia system

### Using Touch Control

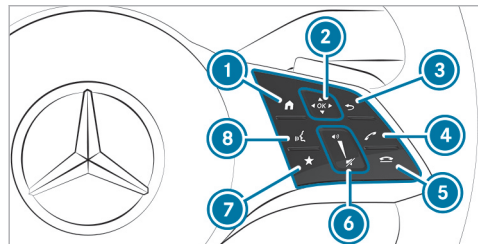

- ① Shows the home screen
- ② Touch Control
  - swipe in the direction of the arrow (navigate)
  - Press (confirm)
- ③ Returns to the previous display
- ④ Makes or accepts a call
- ⑤ Rejects or ends a call
- ⑥ To increase volume: swipe upwards  
To reduce volume: swipe down

To switch off the sound: press

⑦ Calls up favorites

⑧ Starts the MBUX Voice Assistant

① To operate Touch Control ② in the most effective way, use the tip of your thumb if possible.

You can navigate through menus and lists via the touch-sensitive surface of Touch Control ② using a **single-finger swipe**, e.g.:

- ▶ **To enter a character:** select a character using the keyboard and press on Touch Control ②.
- ▶ **To select a menu option:** scroll in a list and press Touch Control ②.
- ▶ **To move the digital map:** swipe in any direction.

### Using the touchscreen

- ▶ **To select a menu item or entry:** tap on a symbol or an entry.
- ▶ **To increase the map scale:** tap twice quickly with one finger.
- ▶ **To reduce the map scale:** tap with two fingers.

▶ **To enter characters with the keypad:** tap on a button.

▶ **To navigate in menus:** swipe up, down, left or right.

▶ **To use handwriting to enter characters:** write the character with one finger on the touchscreen.

▶ **To zoom in and out of the map:** move two fingers together or apart.

▶ **To enlarge or reduce the size of a section of a website:** move two fingers together or apart.

▶ **To turn the digital map:** turn counter-clockwise or clockwise using two fingers.

▶ **To move the digital map:** touch the touchscreen and move your finger in any direction.

▶ **To save the destination in the digital map:** touch the touchscreen and hold until a message is shown.

▶ **To set the volume on a scale:** touch the touchscreen and move your finger to the left or right.

- ▶ To call up a global menu in the applications: touch the touchscreen and hold until the **Options** menu appears.

On the lower control panel of the center console



- ① Turn: adjusts the volume  
Press: switches sound on or off
- ▶ Select a function.

### Function of the MBUX Voice Assistant

**⚠ WARNING** Risk of distraction from information systems and communications equipment

If you operate information systems and communication devices integrated in the vehicle when driving, you could be distracted from the traffic situation. This could also cause you to lose control of the vehicle.

- ▶ Only operate this equipment when the traffic situation permits.
- ▶ If you cannot be sure of this, stop the vehicle whilst paying attention to road and traffic conditions and operate the equipment with the vehicle stationary.

For your own safety, always observe the following points when operating mobile communications equipment and especially your voice control system:

- Observe the legal requirements for the country in which you are driving.

- If you use the voice control system in an emergency your voice can change and your telephone call, e.g. an emergency call, can thereby be delayed.
  - Familiarize yourself with the voice control system functions before starting the journey. Using the MBUX Voice Assistant, vehicle functions and various areas of the MBUX multimedia system can be operated by voice input. The MBUX Voice Assistant is operational approximately half a minute after switching on the vehicle and can be operated from all seats. Further information and examples of voice commands can be found in the Digital Operator's Manual.
- You can use the MBUX Voice Assistant to operate the following functions depending on the vehicle equipment:
- Telephone
  - Text messages and e-mails
  - Navigation
  - Radio and media
  - Vehicle functions
  - Online functions

Full functionality of the voice control system is only available for you with activation of online voice control.

### Conducting a dialog

#### Starting a dialog

- ▶ Say "Hey Mercedes" to activate the MBUX Voice Assistant. Voice activation must be switched on in the multimedia system.

or

- ▶ Press the  button on the multifunction steering wheel. A blue line appears in the MBUX multimedia system. The dialog can be started.

For the dialog with the MBUX Voice Assistant, you can use complete sentences of colloquial language as voice commands. Voice activation can also be directly combined with a voice command, e.g. "Hey Mercedes, how fast can I drive?"

#### Calling up help

- ▶ **For information about the MBUX Voice Assistant:** say "Hey Mercedes, what can you do?"

- ▶ **Digital Operator's Manual:** "Show me the Operator's Manual". The full extent of the Digital Operator's Manual is available when the vehicle is stationary.

#### Operating functions (examples)

- ▶ **To operate the navigation:** "Search for an Asian restaurant, but not Japanese, in South Manhattan."
- ▶ **To operate the phone:** "Call my father."
- ▶ **To change the system language to English (short command):** "Change language to English".
- ▶ **To operate the radio:** "Show me the list of radio stations."
- ▶ **To operate media:** "Switch on random playback."
- ▶ **To operate vehicle functions:** "Switch the seat heating to level 2."
- ▶ **To operate online functions:** "What's the time in Sydney?"
- ▶ **To ask a question about the vehicle:** "Do I have Blind Spot Assist?"

### Overview of the MBUX Interior Assistant

**⚠ WARNING** Risk of injury from the camera's laser radiation

This product uses a classification 1 laser system. If the housing is opened or damaged, laser radiation may damage your retina.

- ▶ Do not open the housing.
- ▶ Always have maintenance work and repairs carried out by a qualified specialist workshop.

This product complies with the requirements of the FDA 21 CFR 1040.10 and 1040.11 with exception of the variations according to the FDA Laser Notice No. 50 from 24. June 2007.

The camera is located in the overhead control panel.

If the vehicle is equipped with the MBUX Interior Assistant, selected functions of the multimedia system can be operated contact-free. The MBUX Interior Assistant can differentiate between driver and front passenger interactions and detects specific hand positions (poses).



### System limits, display messages and notes for rectification

The system may be impaired or may not function in the following situations:

- The camera in the overhead control panel may heat up due to operating conditions. As a result the camera may switch off temporarily, particularly during longer periods of operation and at high outside temperatures.

Do not touch or cover the camera and wait until the camera has cooled down and is available again.

- The camera is covered, dirty, fogged up or scratched.

Wait until the camera has cooled down before cleaning the camera lens.

Clean the outside of the camera lens with a dry or damp cotton cloth. Do not use micro-fiber cloths. Do **not** remove the cover when cleaning.

- Recognition can be impaired by reflective clothing, an adverse color of clothing or by accessories, for example.

- Clothing being worn (hat, shawl, scarf) may be limiting the detection area of the camera.

Keep the camera's field of vision clear.

- The camera is not operational.

Consult an authorized Mercedes-Benz Center.

The MBUX Interior Assistant supports the following interactions:

Interaction area	Interaction	Description
In front of the media display or above the touchpad	Proximity to the control element	The Interior Assistant recognizes the approach of the hand towards a control element. Depending on the active application, the display will be adjusted in the media display. Some functions differentiate between driver and front passenger. No specific hand position is required.
Above the center console	Defined pose	A favorite is called up with a defined pose.

Interaction area	Interaction	Description
Below the inside rearview mirror	Brief up and down movements	With brief up and down movements below the inside rearview mirror the reading light for the driver or the front passenger is switched on or off.
Above the front passenger seat	Stretching out a hand above the front passenger seat	By stretching out a hand above the front passenger seat the search light is switched on. If you withdraw a hand from this area, the search light is switched off again.

### Switching the reading light and search light and on or off

#### Requirements

- **For the reading light:**

- The function is available when it is dark.
- The hand movement takes place in the interaction area below the inside rearview mirror.

- **For the search light:**

- The function is available when it is dark.
- The hand movement takes place in the interaction area above the front passenger seat.

- The seat belt on the front passenger seat must **not** be inserted in the seat belt buckle.

#### Switching the reading light on and off



- ▶ Briefly move a hand up or down beneath the inside rearview mirror. The reading light is switched on or off for the driver or the front passenger.

#### Switching the search light on and off

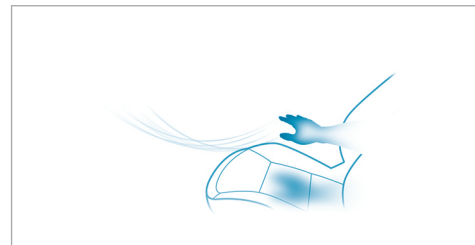

- ▶ **To switch on:** reach across the front passenger seat with a hand. The search light is switched on for the driver.
- ▶ **To switch off:** take a hand back away from the front passenger seat. The search light is switched off again.

### Information on users, suggestions and favorites

**⚠ WARNING** Risk of becoming trapped during adjustment of the driver's seat after calling up a driver profile

Selecting a user profile may trigger an adjustment of the driver's seat to the position saved under the user profile. You or other vehicle occupants could be injured in the process.

- ▶ Make sure that when the position of driver's seat is being adjusted using the multimedia system, no people or body parts are in the seat's range of movement.

If there is a risk of someone becoming trapped, immediately stop the adjustment process by:

- ▶ a) Pressing the warning message on the central display.
- or
- ▶ b) Pressing a position button of the memory function or a seat adjustment switch in the driver's door. The adjustment process is stopped.

The driver's seat is equipped with an anti-entrapment feature.

If the driver's door is open, the driver's seat will **not** be set after calling up the driver's profile.

### User profiles and user-specific content

Prerequisites for the vehicle owner:

- You have a Mercedes me user account.
  - You have a Mercedes me PIN.
  - You have agreed to the terms of use.
  - The vehicle is linked to a Mercedes me user account.
- ⓘ If one of the pre-requisites listed is missing or if no user profile has been selected, the data described in the following section will be

saved in the vehicle as the standard setting. Standard settings can be changed by all vehicle users.

User profiles save personal settings. If the vehicle is used by several people, a person can change their profile settings without changing the settings of other users.

You can individualize a user profile in the vehicle using the set-up assistant or using the settings in your user profile. Some settings, e.g. the Mercedes me PIN and a profile photo are made in the Mercedes me App or in the Mercedes me Portal.

User-specific content and applications with personal data are protected by different levels of security. To access protected content, the Mercedes me PIN and, depending on the vehicle equipment, biometric sensors can be used.

- ⓘ The security level is set by the multimedia system and calculated from the combination of all sensor inputs. Some security levels cannot be turned off.

**i** When a user profile is activated, the following personalized comfort systems, for example, can be adjusted or their settings loaded:

- Seat
- Ambient light
- Outside mirrors
- Roller sunblinds
- Climate control settings

If the user profile is activated when driving, the driver's seat position will not be adjusted.

Depending on the vehicle equipment you can, as a user, save the following settings, for example:

- Driver's seat, steering wheel and mirror settings
- Climate control
- Ambient lighting
- Radio (including station list)
- Suggestions and favorites

### Suggestions

The vehicle can learn the habits of the driver. It then makes suggestions regarding navigation des-

tinations, phone numbers and music preferences. The requirements for that are the selection of a user, your consent to the recording of data and sufficient collected data.

### Favorites

Favorites offer you quick access to frequently used applications. 100 favorites are available in total.

### Configuring users, suggestions and favorites

#### Requirements:

- The vehicle is stationary.

Multimedia system:



#### Adding a user

- ▶ Select **+** **Add User**. A QR code is loaded.
- ▶ Scan the displayed QR code with the Mercedes me App or any QR code scanner on a mobile device. If the Mercedes me App is not yet installed on your mobile device, you

will be directed to the store of your mobile device.

- ▶ Follow the directions in the app. The vehicle is connected with your Mercedes me user account. This automatically creates your user profile in the vehicle.

You will be informed when your user profile is available.

When the vehicle is stationary, the set-up assistant starts automatically after user selection.

#### Protecting user-specific content and applications

If you add a new user, access protection is already activated for the user profile. The Mercedes me PIN and, depending on the vehicle equipment, biometric sensors are available for access. Biometric sensors in the vehicle must be taught in. The authentication process then takes all taught-in and available sensors into account.

The following user-specific content and applications are protected, for example:

- User selection and user profile settings
- Biometric sensors

The teaching-in of biometric sensors is protected.

- Suggestions

The data and determination of the most probable navigation destinations, media sources, radio stations, contacts and messages are protected.

- ENERGIZING COACH

The recorded health data and their evaluation are protected.

- Mercedes me connect store

The purchase of services is protected.

▶ Deactivate or activate **Protect Content**.

▶ Deactivate or activate **Access Protection**.

ⓘ When access protection is switched off, your user profile can be viewed from any seat and changes can be made.

ⓘ Access protection is switched on or off on a vehicle-specific basis.

### Setting up, editing and deleting biometric recognition

The biometric data models are saved in the sensors in the vehicle. If recognition has been taught-in, this sensor serves as a contributory factor for authentication on the multimedia system.

▶ Select **Protect Content**.

▶ Select **Voice Recognition**.

ⓘ If necessary, authenticate yourself on the multimedia system.

### Setting up voice recognition

▶ Speak the sentence shown on the media display and follow the voice assistant's instructions.

If voice recognition was successful, a message appears on the media display. You can unlock your user profile.

ⓘ Avoid background or disturbing noises during voice recognition.

### Deleting biometric data

▶ Tap on  behind **Voice Recognition**.

▶ Select **Yes**.

### Selecting a user

ⓘ When you call up your driver profile, the driver's seat and the steering wheel can be set.

You can cancel the setting process with the following actions:

- Tap on the **Tap Here to Cancel** message on the media display.
- Press one of the seat operating buttons in the driver's door.

▶ Select **Select User**.

▶ Select a user.

▶ When requested to do so, authenticate with the Mercedes me PIN or a taught-in biometric characteristic.



The user profile is loaded and activated.

ⓘ If you select **Continue Without Selecting a User**, no specific settings for the user profile are loaded.



### Configuring and deleting suggestions

▶ Select .

▶ Select **Settings**.

- ▶ Select **System**.
- ▶ Select **Suggestions**.
- ▶ Select .
- ▶ Switch the options on or off individually. If an option is switched on and sufficient data has been gathered, personalized suggestions based on your user behavior will be offered to you on the zero layer. These are, for example, navigation destinations visited, phone numbers dialed as well as suggestions based on your music preferences.
- ▶ **To delete collected suggestions:** select .
- ▶ Select **Yes**.  
The suggestions are reset.

#### Adding favorites from categories

- ▶ Select .
- ▶ Select .
- ▶ Select .
- ▶ Select  **Create New Favorite**.
- ▶ Select the category.
- ▶ Select a favorite.

### System settings

#### Overview of the system settings menu

In the system settings menu, you can make settings in the following menus and control elements:

- Display
  - Display brightness
- Control elements
  - Keyboard language and handwriting recognition
  - Sensitivity of Touch Control
  - Haptic operation for the touchscreen
- MBUX voice assistant
- MBUX Interior Assistant
- Sound
  - Entertainment
  - Navigation and traffic announcements
  - Telephone
- Data protection
- Connectivity

- Wi-Fi, Bluetooth®, NFC

- Time & date
- Language
- Units for distance
- System PIN
- Suggestions
- Software update
- System reset

#### Overview of software updates

Important software updates may be necessary for the security of your multimedia system's data. Install these updates, or else the security of your multimedia system cannot be ensured.

The multimedia system displays a corresponding message when a software update is available.

If the **Automatic Online Update** option is active, software updates are downloaded automatically. If the option is deactivated, you will be informed of new software updates once. The software updates are available for downloading for a limited period of time.

Carrying out a software update:

- You can start software updates via the communication module.
  - You can start software updates via a Wi-Fi hotspot.
  - You can start map updates from an external medium.
- i** Online software updates cannot be performed via external Wi-Fi hotspots that are encrypted via TKIP.
- i** If the WLAN hotspot requires logging in via the browser, once the connection is successfully established the browser will open in order to start the update. To start the download follow the instructions in the browser.
- i** To complete software updates via the communication module, the vehicle must be connected with the Internet and a Mercedes me user account.
- i** To complete software updates via Wi-Fi, the vehicle must be connected to an external Wi-Fi hotspot.

A software update consists of three steps:

- Downloading or copying of the data required for installation
  - Installation of the downloaded software update
  - Activation of the downloaded software update
- i** It may be necessary to restart the MBUX multimedia system after completion of a software update.
- i** While some software updates are being downloaded, the multimedia system cannot be operated and the vehicle functions may be restricted.
- i** Some software updates require a safe vehicle status for the installation to be completed. They can only be carried out in a safely parked vehicle with the vehicle switched off.

**For software updates requiring a safe vehicle status:** when the last installation step is reached, a message appears on the media display after the vehicle is switched off. Follow the step-by-step instructions on the media display to complete the installation.

There are software updates that can only be installed when the vehicle is safely parked, there are no more people in the vehicle and the vehicle is locked.

#### Availability of the driver and media display

During the installation of software updates, it is not possible to use the vehicle, media display and driver display. You may receive the following display message when an installation is running:

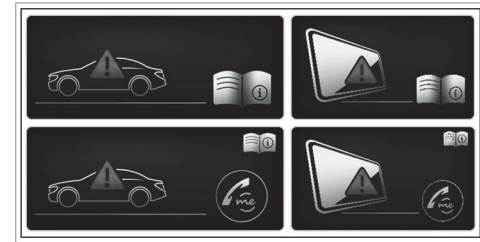

- i** The display message does not appear every time a software update is installed.

In rare cases, an error can occur during the installation. The multimedia system automatically attempts to restore the previous version.

If it is not possible to restore the previous version, the display message shown above appears every time the vehicle is started.

#### Failure of the driver display

If the driver display fails or there is a malfunction, you may not recognize limitations in the functions of systems relevant to safety or the speed display, for example. The operating safety of the vehicle may be impaired. Drive on carefully and have the vehicle checked at a qualified specialist workshop immediately (→ page 368).

Further information about software updates can be found at <https://me.secure.mercedes-benz.com>

#### Failure of the media display

If the media display fails or the display message shown above is shown continuously, several systems such as the reversing camera, Parking Assist PARKTRONIC or climate control are no longer available. Drive on carefully and consult a specialist workshop as soon as possible.

### Setting up a Wi-Fi hotspot

#### Requirements

- The Wi-Fi function is activated on the multimedia system and the communication device to be connected.
- The communication device to be connected supports at least one of the types of connection described.

The connection types shown depend on the device to be connected. The function must be supported by the multimedia system and by the device to be connected. The type of connection must be selected on the multimedia system and on the device to be connected.

- i Some functions may first need to be activated on the communication device being connected. More detailed information can be found in the manufacturer's operating instructions.
- i The use of the vehicle data tariff by external devices is not available in all countries.

Multimedia system:

→  » Settings » System  
» Internet and Bluetooth

- i The availability of the functions is dependent on the country.
- ▶ Select **Wi-Fi**.  
The controller is to the right: Wi-Fi is switched on.

When the Wi-Fi function is switched on, you can connect the multimedia system with external hotspots or make it available as a hotspot for external devices.

When the Wi-Fi function is switched off, it is not possible to establish a hotspot connection.



- i** Depending on the vehicle equipment, you can purchase a data package directly from a mobile phone network provider via the Mercedes me Store. To be able to use the data package, you conclude a separate contract with a mobile phone network provider via the Mercedes me Store, which can be terminated at any time and for which there are no costs. This contract is a prerequisite for using the services from the previously purchased package. The availability of this option is dependent on the country. If the data package option is not available or can be upgraded, you can purchase data volume directly from the mobile phone network provider for a fee.
- i** The use of the vehicle data tariff by external devices is not available in all countries.

#### Using the multimedia system as a Wi-Fi hotspot

- ▶ Select **MBUX Hotspot**.
- ▶ Select one of the following connection options.

#### Connecting using a QR code

Requirement: an app for scanning the QR code is installed on the device being connected.

Alternatively: the device being connected has an integrated QR code scanner (see the manufacturer's operating instructions).

- ▶ Scan the QR code shown.
- ▶ The Wi-Fi connection is established.

#### Connecting using NFC

- ▶ Activate NFC on the device to be connected.
- ▶ When the NFC symbol is displayed in the **MBUX Hotspot** menu, hold the device to be connected to the NFC interface.
- ▶ Follow the instructions on the device.
- ▶ The Wi-Fi connection is established.

#### Connecting using a security key

- ▶ Select the vehicle from the device to be connected. The vehicle is displayed with the **MBUX XXXXX** network name.
- ▶ Enter the security key shown on the device to be connected.
- ▶ Confirm the entry.

#### Generating a new security key

- ▶ Select the **Generate New Security Key** option in the **MBUX Hotspot** menu.
- ▶ Confirm the prompt with **Yes**.
- ▶ A new security key is generated.

A connection will be established with the newly created security key.

- i** When a new security key is generated, all existing Wi-Fi connections are then disconnected. If the Wi-Fi connections are re-established, the new security key must be entered.

#### Using a mobile communication device as a Wi-Fi hotspot (tethering)

- i** This function is country-dependent.
- ▶ Select the **Manage Internet Access** option in the **Internet and Bluetooth** menu.
- i** The Wi-Fi function on the mobile phone and Internet access via Wi-Fi must be activated (see the manufacturer's operating instructions).
- ▶ Select **Search for Access**.

- ▶ Select the network.
  - ▶ Log in to the Wi-Fi network.
- or
- ▶ Select the mobile phone with the  Wi-Fi symbol.
- i** With external Wi-Fi hotspots, which are encrypted via TKIP, online software updates cannot be carried out via the external Wi-Fi hotspot.

## System language

### Notes on the system language

This function allows you to determine the language for the menu displays and the navigation announcements. The selected language affects the characters available for entry. The navigation announcements are not available in all languages. If a language is not available, the navigation announcements will be in English.

### Setting the language

Multimedia system:



### Setting the system language

A list of the available system languages is shown.

- ▶ Select a language.  
The system language is switched to the selected language.

### Resetting the multimedia system (reset function)

**⚠ WARNING** Risk of accident due to failure of central display functions

While the multimedia system is reset, its functions, such as the rear view camera, are not available.

- ▶ Only reset the multimedia system when the vehicle is stationary.

### Requirements:

- The vehicle is switched on.

- The vehicle is stationary.

Multimedia system:



When resetting the system, personal data and settings are deleted, for example:

- Connected devices
- Individual user profiles
- Biometric data

- i** The data used and saved in the multimedia system by the driver assistance systems is deleted.

- ▶ Select **Reset**.  
A query appears asking if the system should really be reset.
- ▶ Select **Yes**.  
The multimedia system is reset to the factory settings. The multimedia system is restarted after the system reset.

- i** Due to data protection, as well as the function of individual driving systems and driving safety systems, it is a requirement to carry out a complete system reset before selling the vehicle or transferring it to a third party, or after use as a hire car.

## Navigation and traffic

### Notes on navigation

#### Route guidance with augmented reality

- ⚠ WARNING** Risk of accident and injury as a result of distraction, incorrect depiction or wrong interpretation of the display

The camera image of the augmented reality display is not suitable as a guide for driving.

- ▶ Always keep an eye on the actual traffic situation.
- ▶ Avoid extended observation of the camera image.

- ⚠ WARNING** Risk of accident and injury due to imprecise positioning of additional information

The additional information from the augmented reality display may be inaccurate and is not a substitute for observing and assessing the actual driving situation.

- ▶ Always keep an eye on the actual traffic situation when carrying out all driving maneuvers.

### Switching navigation on

Multimedia system:



- ▶ Alternatively, press the  button on the steering wheel on the right (→ page 228). The zero layer with the digital map is displayed.

### Navigation overview

#### Digital map

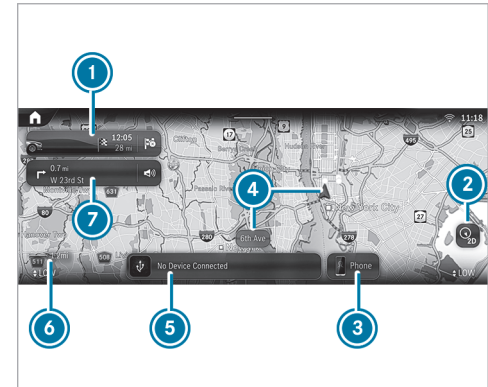

- 1** Navigation module (reduced view)

Route guidance active:

The navigation module shows the information relevant to the route in the zoomed-out view, e.g. the destination or a traffic delay

 Ends the current route guidance

Tapping opens the navigation module and displays the route overview

 Map orientation  and set map type

 Calls up the telephone menu

 Current vehicle position (vehicle symbol or arrow)

 Calls up entertainment applications

 Elevation and map scale

 Navigation window shows the next driving maneuver (zoomed out view) or the route monitor (zoomed in view)

Route guidance active: route monitor shows, e.g. route sections, upcoming driving maneuvers with lane recommendations, destination, traffic delays, 3D images at freeway exits, online content

Pressing  several times changes the map orientation in this order:

- 2D and to the north
- 2D and direction of travel
- 3D and direction of travel

- Map with complete route

 If the map is moved, the map switches between 3D direction of travel and 2D north orientation.

The following map types  are available:





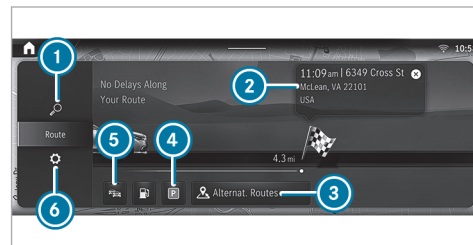

- Daytime display
- Night-time display
- Satellite map

 If you notice a problem with the digital map you can report this under <https://mapfeedback.here.com/#/report>.

## Navigation module (expanded view)



Example: route guidance is active

-  Enters an address or POI
-  Destination and time of arrival  
Below this: current distance to the destination and the checkered flag
-  Alternative routes
-  Searches for parking
-  Switches traffic information display on or off
-  Makes settings for [View](#), [Messages & Acoustic Signals](#) and [Route](#)

## Overview of the toll system

**i** The toll system is optional equipment and is not available in all vehicles.

Debiting of toll charges at freeway toll gates is facilitated with an electronic payment system.

The toll system uses RFID (Radio Frequency Identification) for data transfer between the control unit and the toll station.

The toll system is initially switched off at the factory.

The control unit is in the vehicle glove box.

In order to be able to use the toll system, it must have been registered by the customer and activated by the service provider:

- Activate the toll system in the settings of the MBUX multimedia system or on the control unit.
- There are two ways to register and activate:
  - In the Mercedes me App, register the unit identification number of the control unit and activate the toll system.

- Alternatively, you can register and activate via the **Toll Service** app.

Activation of the toll system can take up to 48 hours after registration.

When the toll system is activated, the automatic detection of the number of vehicle occupants is initially switched off at the factory. The number of vehicle occupants is preset with one person.

The following applies for roads on which toll charges are dependent on the number of vehicle occupants:

- If the automatic detection of the number of vehicle occupants is switched off, the number of vehicle occupants must be selected manually. This ensures correct toll accounting.
- The number of vehicle occupants can be transmitted automatically. In the process, the number of seat belts worn is determined.

If the number of detected persons does not correspond with the number of persons actually in the vehicle, the number of persons must be manually selected.

The standard setting of one person does not need to be changed for roads which require toll payment regardless of the number of vehicle occupants.

The toll system enables the payment of toll charges in many states of the USA.

**i** In Mexico, for example, the toll system can be registered and activated for journeys to the USA.

### Notes on use

- You can only use the toll system once registration and activation are complete.
- Drive at the prescribed vehicle speed in the toll lane.
- Mercedes-Benz recommends operation using the MBUX multimedia system. Alternatively, this can also be done on the control unit in the glove box.
- For safety reasons, entries should be made while the vehicle is stationary.
- For further information, please consult the Mercedes me App or an authorized Mercedes-Benz Center.

Or call 1-800-FOR-MERCEdes (in the USA) or 1-800-387-0100 (in Canada).

For information on how to register and activate the toll system, see the Digital Operator's Manual.

### Destination entry

#### Requirements

##### • For the online search:

- There is an Internet connection.
- Mercedes me connect is available.
- You have set up a user account in the Mercedes me Portal.
- The vehicle is connected with the user account and you have accepted the terms of use.
- Further information can be found at: <https://www.mercedes.me>
- The service is available.
- The service has been activated at an authorized Mercedes-Benz Center.

**i** If Online Search is not available, the search is performed using the data of the digital map.

Multimedia system:

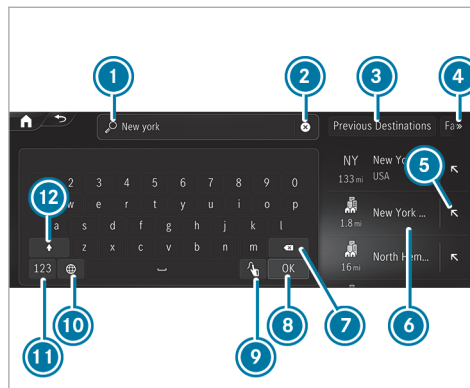

Example: entering a POI or address

- 1 Input line with current entry
- 2 Deletes an entry
- 3 Selecting previous destinations

- 4 Displays and selects additional destination searches
- 5 Adopts the search result in the input line and continues the search
- 6 Search result
- 7 Deletes the last character entered
- 8 Hides the keypad
- 9 Switches to handwriting recognition
- 10 Setting the written language
- 11 Switches to digits and special characters
- 12 Switches to upper-case or lower-case letters

If available, selecting the symbol starts the MBUX voice assistant.

- ▶ Enter the destination in 1. The entries can be made in any order. The search results are displayed in a list.

**i** Online search results for POIs may contain additional information, for example opening times and ratings. The information is provided by an online map service. This online function is not available in all countries.

- ❶ You can enter a destination as a three-word address from what3words. This option is not available in all countries.
- ▶ Hide the keyboard with  **OK**.
- ▶ Select the destination in the list. The following menu shows the selected destination with the address information and a corresponding map section. The menu enables the route to be calculated.
- ❷ Observe the notes on the MBUX multimedia system (→ page 226).

### Calculating a route and using settings for route guidance



Example: detailed display

- ❶ Calls up alternative routes
- ❷ Calculates the route and starts route guidance
- ❸ Selects a point of interest in the vicinity of the destination
- ❹ Destination address

After selection of a destination the route is be calculated.

- ▶ Select one of the options.

### Calling up alternative routes

- ▶ Select **Routes**.
- ▶ Select an alternative route.

### Starting route guidance

- ▶ Select  **Let's Go!**.

### Calling up the detailed display with destination address



- ▶ Pull the bar above ❷ upwards. Depending on the destination selection and availability, online content, for example ratings and weather information, is shown. If the destination is in a different time zone, a message is displayed.
- ▶ **To share a destination:** select  **Share**. This option allows you to scan the displayed QR code.
- ▶ **To save a destination as a favorite:** select  **Favorite** and then an option.
- ▶ **To call up an Internet address:** if a web address is available, select **www**.

- ▶ **To call the destination:** if a telephone number is available, select **Call**.

### Searching for POIs in the vicinity of the destination shown

- ▶ Select **In The Vicinity**.
- ▶ Search using categories, enter a search entry or search for a personal POI.

### Selecting a route type

- ▶ In the navigation module (expanded view), select  (→ page 241).
- ▶ Select **Route**.  
The route is calculated as a fast route with a short journey time. Trailer mode is available if a trailer has been coupled with the vehicle. If available, you can select online routes. Traffic announcements for the route are taken into account via **Reroute Based on Traffic** .
- ⓘ Trailer mode and online routes are not available in all countries and for all vehicles.

### Calculating alternative routes



- ▶ In the navigation module (expanded view), select .
- ▶ Select **View**.
- ▶ Activate **Route Overview after Start**.  
Alternative routes are calculated for every route.

### Selecting alternative routes

- ⓘ If **Route Overview after Start** has been switched on and a route has been calculated, the function is available.
- ▶ In the navigation module (expanded view), select **Alternative Routes**.
- ▶ When the alternative routes have been calculated, display the route in the navigation window by swiping to the right or left.
- ▶ Select **Start**.

### Activating a commuter route

- ⓘ A user profile has been created and **Allow Destination Suggestions** has been activated in the user options (→ page 234). Route guidance is not active.

- ▶ In the navigation module (expanded view), select .
- ▶ Select **Route**.
- ▶ Activate **Commuter Route**.  
The navigation system automatically detects that the vehicle is on a commuter route.  
For the daily commuter route, traffic incidents on the route are also reported when driving without active route guidance.
- ▶ **To select or delete a commuter route:**  
select **Start** or .

### Avoiding or using route sections, e.g. highways or ferries

- ▶ In the navigation module (expanded view), select .
- ▶ Select **Route**.
- ▶ Select **Avoid Options**.
- ▶ Activate or deactivate the avoid option.

### Activating route guidance with augmented reality

- ▶ In the navigation module (expanded view), select .



- ▶ Select **View**.
- ▶ Select **Augmented Reality Video**.
- ▶ Switch **Augmented Reality Video** on or off. The camera's video image is shown on the central display before a turning maneuver. The video image includes additional information.

#### Showing property information for route guidance with augmented reality

Route guidance with augmented reality is activated.

- ▶ In the navigation module (expanded view), select .
- ▶ Select **View**.
- ▶ Select **Augmented Reality Video**.
- ▶ Activate **Street Names** and **House Numbers**. During route guidance, the activated options are shown as additional information in the camera image.

#### Using map functions

Multimedia system:



##### Increasing map scale

- ▶ When the map is shown, tap twice quickly with one finger on the media display.
- or

- ▶ Move two fingers apart on the media display.

##### Decreasing map scale

- ▶ Tap with two fingers on the media display.
- or

- ▶ Move two fingers together on the media display.

##### Moving the map

- ▶ When the map is displayed, swipe in any direction with one finger on the media display.
- ▶ **To reset the map to the current vehicle position:** select  **Center**.

#### Selecting map orientation

- ▶ Tap repeatedly on the  compass symbol on the map.

The map orientations changes in this order:

- The 2D map view is displayed so that north is always at the top.
- The 2D map view is aligned to the direction of travel.
- The 3D map view is aligned to the direction of travel.
- The map shows the complete route.

#### Using services

##### Requirements:

- There is an Internet connection.
- Mercedes me connect is available.
- You have set up a user account in the Mercedes me Portal.
- The vehicle is connected to a user account and you have accepted the conditions of use for the service.

Further information can be found at: <https://www.mercedes.me>

- The service is available.
- The service has been activated at an authorized Mercedes-Benz Center.

Multimedia system:



### Showing traffic information

- ▶ In the navigation module (expanded view), select  (→ page 241).
- ▶ Select [View](#).
- ▶ Activate [Traffic](#).
- ▶ Activate [Traffic Incidents](#) and [Free Flowing Traffic](#).  
Traffic incidents, for example roadworks, local area reports (e.g. fog) and warning messages, are shown on the route.  
The traffic delay is displayed for the current route. The smallest value for the display for traffic delays is a minute.

### Displaying hazard warnings

If hazard warnings are available these can be shown as symbols on the map. The display depends on the settings for the [Traffic Incidents](#) option.

- ▶ In the navigation module (expanded view), select  (→ page 241).
- ▶ Switch [Traffic Incidents](#) on or off.  
If the option is activated, all of the symbols are shown.  
If the option is deactivated, the symbols are only shown when there is a hazard warning.  
The following hazards may be shown on the map:
  - Accidents and breakdowns
  - Slippery roads, fog, crosswinds and heavy rain
  - Hazards reported manually
  - Vehicle with active hazard warning light
  - Roadworks
  - Additional hazards (if available)

### Displaying online map contents

- ▶ In the navigation module (expanded view), select .
- ▶ Select [View](#).
- ▶ Switch on an online service, e.g. [Weather](#).  
Current weather information is displayed on the navigation map, e.g. temperature or cloud cover.  
The service information is not shown in all map scales, e.g. weather symbols.

### Parking service

**!** **NOTE** Damage to the vehicle due to not observing the maximum permitted headroom clearance

If the vehicle height is greater than the maximum permitted headroom clearance, the roof and other parts of the vehicle may be damaged.

- ▶ Observe the signposted headroom clearance.

- ▶ If the vehicle height is greater than the permitted headroom clearance, do not enter.
- ▶ Observe the changed vehicle height with add-on roof equipment.

**!** **NOTE** Vehicle damage due to failure to observe local information and parking conditions

The data is based on the information provided by the respective service providers.

Mercedes-Benz does not guarantee the accuracy of the information provided in relation to the car park or parking area.

- ▶ Always observe the local information and conditions.

**i** This service is not available in all countries.

▶ In the navigation module (expanded view), select  and switch on **Parking**.

▶ Tap on **P** on the map.

or

- ▶ In the route overview, select **P** **Parking Spaces**.
- ▶ Select the search position and search filter, e.g. **Near Destination** and **Parking Garages**. The map shows car parks suited to the selected settings.
- ▶ Select a parking option.  
The map shows the parking options in the vicinity.

The following information is shown (if available):

- Destination address, distance from current vehicle position and arrival time
- Information on the parking garage/car park

For example, opening times, parking charges, current occupancy, maximum parking time, **maximum access height**.

The maximum access height shown by the parking service does not replace the need for observation of the actual circumstances.

- Available payment options (Mercedes pay, coins, bank notes, cards)
  - Details on parking tariffs
  - Number of available parking spaces
  - Payment method (e.g. at parking meters)
  - Services/facilities at the parking option
  - Telephone number
- ▶ Calculate the route (→ page 245).

### Notes on the dashcam

**!** **NOTE** Risk of legal consequences due to violation of legal regulations and data protection provisions

You are legally responsible for operation and use of the dashcam functions.

The legal requirements relating to operation and use of the dashcam can vary depending on the country in which the dashcam is operated.

This function is not permitted in all countries.

- ▶ Before using the dashcam, read up on the content of the legal regulations, in particular the data protection requirements in the respective country of use.
- ▶ Observe the legal regulations, in particular the data protection requirements.

- i** Observe the following instructions for safe operation:
- Only use FAT32 or exFAT formatted USB storage devices.
  - Use USB-IF certified USB storage devices.  
USB-IF is a non-profit corporation and stands for USB Implementers Forum. Based on the USB specification, USB-IF certifies, for example, USB versions, corresponding cables and plugs as well as energy supply processes via the USB interface.
  - USB storage devices may be damaged if often or permanently overwritten at high speed. Mercedes-Benz recommends a high-quality external SSD drive.

The abbreviation SSD stands for Solid State Drive.

- i** The file size and therefore the duration of single recording is limited by the limitations of the USB flash drive format. So FAT32 formatted USB flash drives do not allow files larger than 4 GB, for example.  
When the file size is reached, the recording stops and you receive a notification.
- i** The following functions are available in the Gallery app:
- Switching write protection on or off
  - Deleting video files

#### Selecting a USB device for a video recording with the dashcam

##### Requirements:

- At least one USB device is connected with the multimedia system .

Multimedia system:

**Apps >> Dashcam**

- ▶ Select the USB symbol.
- ▶ Select the USB device.
- i** When USB devices contain multiple partitions, recorded video files are not always displayed in the recording list.  
Mercedes-Benz recommends that you use USB devices with one partition.

#### Starting or stopping loop recording with the dashcam

##### Requirements:

- For recording and saving a video file: a USB device is connected with the multimedia system.
- The vehicle is switched on.

Multimedia system:

→  » Apps » Dashcam

- ▶ If several USB devices are connected with the multimedia system, select a USB device (→ page 250).  
If no USB device is selected, a selection is made automatically when recording starts.
  - ▶ **To select the recording mode:** select [Loop Recording](#).  
[Loop Recording](#) records several short video files. When the memory is full, recording is continued automatically. In doing so, other files will be overwritten starting with the oldest file.
  - ▶ **To start:** select [Start Recording](#).  
The length of the recording is shown. The [Do not remove the storage medium during recording. Before removing the storage medium, eject it first.](#) message appears. The video file is stored on the USB device.
  - ▶ **To end:** select [End Recording](#).
- i** In some countries, geo-coordinates (longitude and latitude) are shown in the video image.

For technical reasons, the geo-coordinates may show greater inaccuracies.

A report may appear in the following cases:

- The camera is not functional, the [Camera Unavailable](#) message appears.  
Have the camera checked in an authorized Mercedes-Benz Center.
- If the country border indication has been switched on.
- If an outdoor recording is started with the camera app during a dashcam recording, the dashcam recording pauses and resumes automatically after the camera recording is finished. A notification to this effect is displayed.

#### Starting or stopping an individual recording with the dashcam

##### Requirements:

- For recording and saving a video file: a USB device is connected with the multimedia system.
- The vehicle is switched on.

Multimedia system:

→  » Apps » Dashcam

- ▶ If several USB devices are connected with the multimedia system, select a USB device (→ page 250).  
If no USB device is selected, a selection is made automatically when recording starts.
  - ▶ **To select the recording mode:** select [Individual Recording](#).  
[Individual Recording](#) stops recording when the memory limit is reached. An individual recording is automatically protected against being overwritten.
  - ▶ **To start:** select [Start Recording](#).  
The length of the recording is shown. The [Do not remove the storage medium during recording. Before removing the storage medium, eject it first.](#) message appears. The video file is stored on the USB device.
  - ▶ **To end:** select [End Recording](#).
- i** In some countries, geo-coordinates (longitude and latitude) are shown in the video image.  
For technical reasons, the geo-coordinates may show greater inaccuracies.

A report may appear in the following cases:

- **Individual Recording:** the memory is full or there are only a few minutes recording time available. The video recording stops or will be stopped imminently.  
Change the USB device or delete a video file.
- The camera is not functional, the **Camera Unavailable** message appears.  
Have the camera checked in an authorized Mercedes-Benz Center.
- If the country border indication has been switched on.
- If an outdoor recording is started with the camera app during a dashcam recording, the dashcam recording pauses and resumes automatically after the camera recording is finished. A notification to this effect is displayed.

## Telephone

### Telephony

#### Notes on telephony

**⚠ WARNING** Risk of distraction from operating integrated communication equipment while the vehicle is in motion

If you operate communication equipment integrated in the vehicle when driving, you could be distracted from the traffic situation. This could also cause you to lose control of the vehicle.

- ▶ Only operate this equipment when the traffic situation permits.
- ▶ If you cannot be sure of this, stop the vehicle whilst paying attention to road and traffic conditions and operate the equipment with the vehicle stationary.

**⚠ WARNING** Risk of accident from operating mobile communication equipment while the vehicle is in motion

Mobile communication devices distract the driver from the traffic situation. This can also cause the driver to lose control of the vehicle.

- ▶ As a driver, only operate mobile communication devices when the vehicle is stationary.
- ▶ As a vehicle occupant, use mobile communication devices only in the designated area, e.g. in the rear passenger compartment.

You must observe the legal requirements for the country in which you are currently driving when operating the multimedia system and mobile communication equipment in the vehicle.

**⚠ WARNING** Risk of injury due to objects being stowed incorrectly

If objects in the vehicle interior are stowed incorrectly, they can slide or be thrown around

and hit vehicle occupants. In addition, cup holders, open stowage spaces and mobile phone receptacles cannot always retain all objects within.

There is a risk of injury, particularly in the event of sudden braking or a sudden change in direction.

- ▶ Always stow objects so that they cannot be thrown around in such situations.
- ▶ Always make sure that objects do not protrude from stowage spaces, parcel nets or stowage nets.
- ▶ Close the lockable stowage spaces before starting a journey.
- ▶ Always stow and secure heavy, hard, pointed, sharp-edged, fragile or bulky objects in the trunk/cargo compartment.

Observe the additional information on stowing mobile communications devices correctly:

- Loading the vehicle (→ page 107)

#### **Bluetooth® connection:**

The menu view and the available functions in the telephone menu are in part dependent on the Bluetooth® profile of the connected mobile phone. If the mobile phone supports all the following Bluetooth® profiles, the full range of features is available:

- PBAP (Phone Book Access Profile)
  - The contacts on the mobile phone are shown automatically on the multimedia system.
- MAP (Message Access Profile)
  - The mobile phone message functions can be used on the multimedia system.
- HFP (hands-free profile)
  - Wireless telephony is available on the multimedia system.
- SAP (SIM Access Profile)
  - The car telephone has access to the SIM card data and dials into the mobile phone network via the exterior antenna.

Irrespective of this, Bluetooth® audio functionality can be used with any mobile radio unit.

For information on the range of functions of the mobile radio unit to be connected, see the manufacturer's operating instructions.

#### **Network connection:**

The following cases can lead to the call being disconnected while the vehicle is in motion:

- You switch into a transmission/reception station, in which no communication channel is free.
- The SIM card used is not compatible with the network available
- A mobile phone with "Twincard" is logged into the network with the second SIM card at the same time

The multimedia system supports calls in HD Voice® for improved speech quality. A requirement for this is that the mobile phone and the mobile phone network provider of the person you are calling support HD Voice®.

Depending on the quality of the connection, the voice quality may fluctuate.

Further information can be obtained from an authorized Mercedes-Benz Center or at: <https://www.mercedes-benz.com/connect>.

### Telephone menu overview

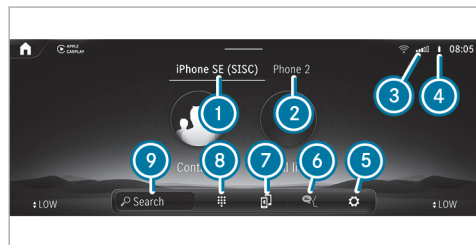

- 1 Bluetooth® device name of the currently connected mobile phone/of the mobile phone
- 2 Bluetooth® device name of the currently connected mobile phone/of the mobile phone (two phone mode)
- 3 Signal strength of the mobile phone network
- 4 Battery status of the connected mobile phone
- 5 Options
- 6 Messages

- 7 Calls up devices
- 8 Numerical pad
- 9 Starts contact search

### Telephony operating modes overview

Depending on your equipment, the following telephony operating modes are available:

- A mobile phone is connected to the multimedia system via Bluetooth®.
- Two mobile phones are connected with the multimedia system via Bluetooth® (two phone mode).
  - You can use all the functions of the multimedia system with both mobile phones.

### Connecting a mobile phone

#### Requirements

- Bluetooth® is activated on the mobile phone (see the manufacturer's Operator's Manual).
- Bluetooth® is activated on the multimedia system.

Multimedia system:



### Searching for a mobile phone

- ▶ Select **Connect New Device**.

### Connecting a mobile phone

- ▶ Select a mobile phone.  
A code is displayed in the multimedia system and on the mobile phone.
- ▶ If both codes match, confirm the code on the mobile phone.

### Functions in the telephony menu

In the telephony menu you have the following functions, for example:

- Making calls, e.g.:
  - Accepting a call
  - **End Call**
  - Answering a call with a message
  - **Conference**
  - Accepting or rejecting a waiting call



- Managing contacts, e.g.:
  - Downloading mobile phone contacts
  - Managing the format of a contact's name
  - Deleting favorites
- Receiving and sending messages, e.g.:
  - Using the read-aloud function
  - Dictating a new message

### Mercedes me Apps

#### Mercedes me calls

##### ■ Making a call via the overhead control panel

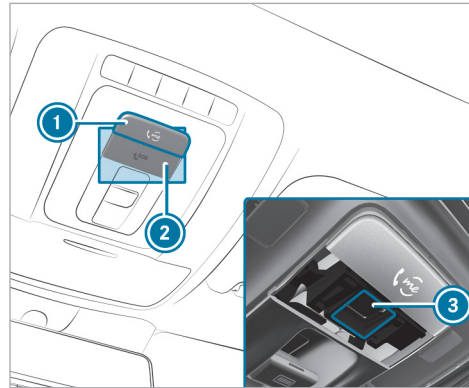

- ① me button for service or information calls
- ② SOS button cover
- ③ SOS button (emergency call system)

#### Making a Mercedes me call

- ▶ Press me button ①.

#### Making an emergency call

- ▶ To open the cover of SOS button ②, press it briefly.
- ▶ Press and hold SOS button ③ for at least one second.

If a Mercedes me call is active, an emergency call can still be triggered. This has priority over all other active calls.

#### ■ Information about the Mercedes me call using the me button

A call to the Mercedes-Benz Customer Center has been initiated via the me button in the overhead control panel or the multimedia system (→ page 255).

Using the voice dialog system you access the desired service:

- Accident and Breakdown Management
- Mercedes-Benz Customer Center for general information about the vehicle

You can find information on the following topics:

- Activation of Mercedes me connect
- Operating the vehicle
- Nearest authorized Mercedes-Benz Center
- Other products and services from Mercedes-Benz

Data is transferred during the connection to the Mercedes-Benz Customer Center (→ page 257).

### ■ Calling the Mercedes-Benz Customer Center using the multimedia system

#### Requirements

- Access to a GSM network is available.
- The contract partner's GSM network coverage is available in the respective region.
- The vehicle must be switched on so that vehicle data can be transferred automatically.

Multimedia system:



#### ▶ Call Mercedes me connect.

After confirmation, the multimedia system sends the required vehicle data. The data transfer is shown in the display.

Then you can select a service and be connected to a specialist at the Mercedes-Benz Customer Center.

### ■ Calling the Mercedes-Benz Customer Center after automatic accident or breakdown detection

#### Requirements:

- The vehicle has detected an accident or breakdown situation (→ page 165).
- The vehicle is stationary.
- The hazard warning lights are switched on.

 This function is not available in all countries.

The vehicle can detect accident or breakdown situations under certain circumstances.

Requirements for collision detection in the context of accident recovery:

- The vehicle is equipped with an anti-theft alarm system (ATA) (code 551).
- The vehicle is equipped with the interior protection (code 882).
- The vehicle is equipped with the Anti-Theft Protection Package (code P54).
- The collision detection service with theft notification has been activated on Mercedes me connect.

If a collision is detected when the tow-away protection is armed on a locked vehicle, you will receive a notification in the multimedia system when you switch the vehicle on.

The message informs you about the potentially affected area of the vehicle and the strength of the collision.

In the event an accident or breakdown is detected, the emergency guide shows safety notes in the multimedia system display. This may take a few seconds.

- ❗ The availability of collision detection depends on the vehicle.

After quitting the emergency guide display on the multimedia system, a prompt appears asking whether you would like to get support from the Mercedes-Benz Customer Center.

▶ Select **Call**.

- After your agreement, or if the Mercedes me connect service "Accident and Breakdown Management" is active, the vehicle data is transferred automatically (→ page 259).
- The Mercedes-Benz Customer Center takes your call and organizes the breakdown and accident assistance.

You may be charged for these services.

- ❗ Depending on the severity of the accident, an automatic emergency call can be initiated. This has priority over all other active calls (→ page 263).
- ❗ In addition, if the Mercedes me connect service "Telediagnosics" is active, a similar prompt can appear after a delay in the event

of a breakdown. If you are already in contact with the Mercedes-Benz Customer Center or have already received support, this prompt can be ignored or declined.

- ❗ If you answer the prompt for support from the Mercedes-Benz Customer Center with **Call Later**, the message will be hidden and appear again later. The prompt triggered by the Mercedes me connect service "Telediagnosics", can either be confirmed or declined. After being declined, this will not be shown again.

### ■ Arranging a service appointment via a Mercedes me call

If you have activated the maintenance management service, relevant vehicle data is transferred automatically to the Mercedes-Benz Customer Center. You will then receive individual recommendations regarding the maintenance of your vehicle.

Regardless of whether you have consented to the maintenance management service, the multimedia system reminds you after a certain amount of

time that a service is due. A prompt appears asking if you would like to make an appointment.

▶ **To arrange a service appointment:** select **Call**. After your consent, the vehicle data is transferred and the Mercedes-Benz Customer Center takes your preferred appointment date. The information is then sent to your desired service outlet.

This will contact you to confirm the appointment and if necessary consult about the details.

- ❗ If you select **Call Later** after the service message appears, the message is hidden and reappears at a later time.

### ■ Data transferred during a Mercedes me call

If you initiate a service call using Mercedes me, data is transferred to enable targeted advice and an efficient service.

The following requirements must be fulfilled for the transfer of the data:

- The vehicle is switched on.
- The required data transfer technology is supported by the mobile phone network provider.

- The quality of the mobile connection is sufficient.

Multi-stage transfer depends on the following factors:

- Reason for the initiation of the call
  - The available mobile phone transmission technology
  - The activated Mercedes me connect services
  - The service selected in the voice control system
- i** The scope of the data transmitted depends on the vehicle model and vehicle equipment. For technical reasons, not all data is available at all times.

#### Data transfer if Mercedes me connect services are not activated

If no Mercedes me connect services are activated, the following data is transferred:

- Vehicle identification number
- Time of the call
- Reason for the initiation of the call

- Confirmation of the data protection prompt
- Country indicator of the vehicle
- Set language for the multimedia system
- Telephone number of the communication platform installed in the vehicle

If a call is made for a service appointment via the service reminder, the following data is also transmitted:

- Current mileage and maintenance data

If a call is made after automatic accident or breakdown detection using the multimedia system, the following data is also transmitted:

- Current mileage and maintenance data
- Current vehicle location

If Accident and Breakdown Management is called via the voice control system, the following data can also be called up from the vehicle by the Mercedes-Benz Customer Center:

- Current vehicle location

#### Data processing

The data transmitted within the scope of the call is deleted from the processing system after the call is finished, in so far as this data is not being used for other activated Mercedes me connect services.

The incident-specific data is processed and stored in the Mercedes-Benz Customer Center and, if required to process the incident, forwarded to the service partner authorized by the Mercedes-Benz Customer Center. Take note of the data protection information on the Mercedes me Internet page <https://www.mercedes.me> or in the recorded message immediately after calling the Mercedes-Benz Customer Center.

- i** The recorded message is not available in every country.

#### Mercedes me connect

##### Information on Mercedes me connect

Mercedes me connect consists of multiple services.

You can use the following services via the multimedia system and the overhead control panel, for example:

- Accident and Breakdown Management (me button or situation-dependent display in the multimedia system)
- Mercedes-Benz Emergency Call System (automatic emergency call and SOS button)

The Mercedes me connect Accident and Breakdown Management and the Mercedes-Benz emergency call center are available to you around the clock.

The me button and the SOS button can be found on the vehicle's overhead control panel (→ page 255).

You can also call the Mercedes-Benz Customer Center using the multimedia system (→ page 256).

Please note that Mercedes me connect is a Mercedes-Benz service. In emergencies, first call the national emergency services using the standard national emergency service telephone numbers. In emergencies, you can also use the

Mercedes-Benz emergency call system (→ page 263).

Please note the Mercedes me connect terms of use and the data protection information for Mercedes me connect. You can find these in your Mercedes me user account.

Further information about Mercedes me connect services can be obtained in the Mercedes me Portal: <https://me.secure.mercedes-benz.com>

### ■ Information on Mercedes me connect Accident and Breakdown Management

 Accident and Breakdown Management is not available in every country. Contact an authorized Mercedes-Benz Center to find out whether this function is available in your country.

The Accident and Breakdown Management can include the following functions:

- Supplement to the Mercedes-Benz emergency call system (→ page 263)

If necessary, the contact person at the Mercedes-Benz emergency call center forwards the call to Mercedes me connect Acci-

dent and Breakdown Management. Forwarding the call is however not possible in all countries.

- Breakdown assistance by a technician on location and/or the towing away of the vehicle to the nearest authorized Mercedes-Benz Center

You may be charged for these services.

- Addition to the emergency guide after automatic accident or breakdown detection (→ page 256)

In the event of a breakdown or accident, further vehicle data is sent which enables optimal support by the Mercedes-Benz Customer Center and the authorized service partner or breakdown assistance.

- Addition to the Mercedes me connect service Telediagnosics

With the Telediagnosics function, specific wear and failure reports are recorded by the service provider, in so far as these can be clearly interpreted and are available through the monitoring of components that are subject to diagnostics.

If your vehicle detects a breakdown or threat of a breakdown, you may be prompted via the multimedia system to contact the Mercedes-Benz Customer Center for further help. This prompt in the multimedia system only appears when the vehicle is stationary.

- ⓘ These services are subject to technical restrictions such as the mobile phone coverage, mobile network quality and the ability of the processing systems to interpret the transferred data. In some circumstances, this can result in delays or the failure of the information to appear in the multimedia system.

Please note that the service and breakdown call is a Mercedes-Benz service. In emergencies, be sure to contact the usual national emergency number first or use the Mercedes-Benz emergency call system (→ page 262).

More information about Mercedes me connect services can be obtained in the Mercedes me Portal: <https://me.secure.mercedes-benz.com>

### ■ Data transferred during Mercedes me connect call services

The data transferred during a Mercedes me connect call depends on:

- The reason for initiation of the call
- The service that is selected in the voice control system
- The activated Mercedes me connect services

You can find out which data is transferred when using the services in the currently valid Mercedes me connect terms of use and the data protection information for Mercedes me connect. You can find these in your Mercedes me user account.

### Overview of the Mercedes me & Apps menu

When you log in with a user account to the Mercedes me Portal, then services and offers from Mercedes-Benz will be available to you.

For more information consult an authorized Mercedes-Benz Center or visit the Mercedes me Portal: <https://me.secure.mercedes-benz.com>

- ⓘ Make sure you always keep the Mercedes me Apps updated.

You can call up the menu using **Apps** in the multimedia system.

In the **Apps** menu, the following options can be available:

- Connecting the vehicle with the **Mercedes me** user account
- Deleting a connection between a user account **Mercedes me** and the vehicle
- Calling up the Mercedes me services
- Calling up apps such as In-Car Office or the web browser depending on availability

## Web browser overview



- ① Previous website
- ② Next website
- ③ Update
- ④ URL
- ⑤ Adds/removes bookmarks
- ⑥ Options
- ⑦ Settings

① Under **[...]** you have the following options:

- [Tabs](#)
- [Bookmarks & History](#)
- [Reading Mode](#)

- [Share Link](#)
- [Share Content](#)
- [Request Mobile Website](#)

① Websites cannot be shown while the vehicle is in motion.

## Overview of Smartphone Integration

With Smartphone Integration, you can use certain functions on your mobile phone via the multimedia system display.

Only one mobile phone at a time can be connected via Smartphone Integration to the multimedia system. Also for use with two phone mode with Smartphone Integration, only one additional mobile phone can be connected using Bluetooth® with the multimedia system.

The full range of functions for Smartphone Integration is only possible with an internet connection. The appropriate application must be downloaded on the mobile phone to use Smartphone Integration. The mobile phone must be switched on and connected to the multimedia system via the USB port using a suitable cable.

Apps for Smartphone Integration:

- Apple CarPlay® (wireless connection via Bluetooth® also possible)
- Android Auto (wireless connection via Bluetooth® also possible)

① For safety reasons, the first activation of Apple CarPlay® or Android Auto on the multimedia system must be carried out when the vehicle is stationary with the parking brake.

You can start Smartphone Integration using the [Devices](#) menu.

You can end Smartphone Integration via the [Devices](#) or by disconnecting the connecting cable between the mobile phone and multimedia system.

① Mercedes-Benz recommends disconnecting the connection via the device manager or the connecting cable only when the vehicle is stationary.

## Overview of transferred vehicle data

When using Smartphone Integration, certain vehicle data is transferred to the mobile phone. This

enables you to get the best out of selected mobile phone services. Vehicle data is not directly accessible.

The following system information is transmitted:

- Software release of the multimedia system
- System ID (anonymized)

The transfer of this data is used to optimize communication between the vehicle and the mobile phone.

To do this, and to assign several vehicles to the mobile phone, a vehicle identifier is randomly generated.

This has no connection to the vehicle identification number (VIN) and is deleted when the multimedia system is reset (→ page 240).

The following driving status data is transmitted:

- Transmission position engaged
- Distinction between parked, standstill, rolling and driving
- Day/night mode of the driver's display
- Drive type

The transfer of this data is used to alter how content is displayed to correspond to the driving situation.

The following position data is transmitted:

- Coordinates
- speed
- Compass direction
- Acceleration direction

The mobile phone uses this data to improve the accuracy of navigation, for example, when driving through a tunnel.

### Mercedes-Benz emergency call system

#### Information on the Mercedes-Benz emergency call system

Your vehicle is equipped with the Mercedes-Benz emergency call system ("eCall"). This feature can help save lives in the event of an accident. eCall in no way replaces assistance provided from dialing 911.

Mercedes-Benz eCall only functions in areas where mobile phone coverage is available from the wireless service providers. Insufficient network coverage from the wireless service providers may result in an emergency call not being transmitted.

eCall is a standard feature in your Mercedes-Benz vehicle. In order to function as intended, the system relies on the transmission of data detailed in the Transmitted Data section that follows.

To disable eCall, a customer must visit an authorized Mercedes-Benz Service department to deactivate the vehicle's communication module.

Deactivation of this module prevents the activation of any and all Mercedes me connect services. After the deactivation of eCall, automatic emergency call and manual emergency call will not be available.

The vehicle must be switched on before an automatic emergency call can be made.

 eCall is activated at the factory.



- ❗ eCall can be deactivated by an authorized Mercedes-Benz dealer. Please note that in the event ownership of the vehicle is transferred to another owner in its deactivated state, eCall will remain deactivated unless the new owner visits an authorized Mercedes-Benz dealership to reactivate the system.

### Overview of the Mercedes-Benz emergency call system

eCall can help to reduce the time between an accident and the arrival of emergency services at the site of the accident. It helps locate an accident site in places that are difficult to access. However, even if a vehicle is equipped with eCall, this does not mean the system is ON. As such, eCall does not replace dialing 911 in the event of an accident.

An emergency call can be made automatically or manually.

Only make emergency calls if you or others are in need of rescue. Do not make an emergency call in the event of a breakdown or a similar situation.

### Messages on the display

SOS NOT READY: the vehicle is not on or eCall not available.

During an active emergency call, <schar> appears in the display.

You can find more information on the regional availability of eCall at: <https://www.mercedes-benz-mobile.com/extra/ecall/>

- ❗ If there is a malfunction of the emergency call system, the loudspeakers, microphone, air bag or the SOS button, for example, are faulty.

You can recognize a malfunction in the emergency call system by the following displays:

- A corresponding message will also appear in the driver's display.
- The SOS button lights up red continuously.

### Triggering an automatic Mercedes-Benz emergency call

#### Requirements:

- The vehicle is switched on.

- The starter battery is sufficiently charged.

The Mercedes-Benz emergency call system triggers an emergency call automatically in the following cases:

- After activation of the restraint systems such as air bags or Emergency Tensioning Devices after an accident

The emergency call has been made:

- A voice connection is made to the Mercedes-Benz emergency call center.
- A message with accident data is transmitted to the Mercedes-Benz emergency call center.

The Mercedes-Benz emergency call center can transmit the vehicle position data to one of the emergency call centers.

The SOS button in the overhead control panel flashes until the emergency call is finished.

It is not possible to immediately end an automatic emergency call.

If no connection can be made to the emergency services either, a corresponding message appears in the media display.

- ▶ Dial the local emergency number on your mobile phone.

If an emergency call has been initiated:

- Remain in the vehicle if the road and traffic conditions permit you to do so until a voice connection is established with the emergency call center operator.
- Based on the call, the operator decides whether it is necessary to call rescue teams and/or the police to the accident site.
- If no vehicle occupant answers, an ambulance is sent to the vehicle immediately.

### Triggering a manual Mercedes-Benz emergency call

- ▶ **To use the SOS button in the overhead control panel:** press the SOS button at least one second long (→ page 255).

or

- ▶ **To use voice control:** use the voice commands of the MBUX Voice Assistant.

The emergency call has been made:

- A voice connection is made to the Mercedes-Benz emergency call center.
- A message with accident data is transmitted to the Mercedes-Benz emergency call center.

The Mercedes-Benz emergency call center can transmit the vehicle position data to one of the emergency call centers.

- Remain in the vehicle if the road and traffic conditions permit you to do so until a voice connection is established with the emergency call center operator.
- Based on the call, the operator decides whether it is necessary to call rescue teams and/or the police to the accident site.

If no connection can be made to the emergency services, a corresponding message appears in the central display.

- ▶ Dial the local emergency number on your mobile phone.

### Ending an unintentionally triggered manual Mercedes-Benz emergency call

- ▶ Select <schar> on the multifunction steering wheel. Depress button for several seconds.

### Data transfer of the Mercedes-Benz emergency call system

In the event of an automatic or manual emergency call the following data is transmitted, for example:

- Vehicle's GPS position data
- GPS position data on the route (a few hundred meters () before the incident)
- Direction of travel
- Vehicle identification number
- Vehicle drive type
- Number of people detected in the vehicle
- Whether Mercedes me connect is available or not
- Whether the emergency call was initiated manually or automatically
- Time of the accident

- Language setting on the multimedia system

Data transmitted is vehicle information. For any questions about the collection, use and sharing of the eCall system data, please contact MBUSA's Customer Assistance Center at 800-FOR-MERC.

For Canada, please contact MBC's Customer Assistance Center at 1-800-387-0100.









Customer requests for covered information should be submitted via the same channels.





For accident clarification purposes, the following measures can be taken up to an hour after the emergency call has been initiated:

- The current vehicle position can be determined.
- A voice connection to the vehicle occupants can be established.

## Radio &amp; media

## Overview of the symbols and functions in the media menu







Symbol	Designation	Function
	Play	Select to start or continue playback.
	Rest	Select to pause the playback.
	Repeat a track	Select to repeat the current track or the active playlist. <ul style="list-style-type: none"> <li>• Select once: the active playlist is repeated.</li> <li>• Select twice: the current track is repeated.</li> <li>• Select three times: the function is deactivated.</li> </ul>
	Random playback	Select to play back the tracks in random order.
	Skip forwards/back	Select to skip to the next or to the previous track.
	Additional options	Select to show additional options.
	Categories	Select to show and search through available categories such as playback lists, albums or artists.
	Search	Select to search in the active menu. You can search for artists, genres or moods, for example.

Symbol	Designation	Function
	Settings	Select to make settings.
	Home	Select to return to the home screen.
	Messaging	Select to call up messaging.
	Full screen	Select to switch to full screen mode.

The following functions and settings are available in the **Media** menu:





- Connecting external data storage media with the multimedia system (e.g. using USB or Bluetooth®)
- Playing back audio or video files

### Overview of the symbols and functions in the radio menu

Symbol	Designation	Function
	Home	Select to return to the home screen.
	Messaging	Select to call up messaging.
	Skip forwards/back	Select to skip to the next or to the previous station.
	Settings	Select to have further options shown. The setting options are country-dependent.
HD	HD radio™	Select to switch the HD Radio™ function on or off. This function is not available in all countries.
	Station list	Select to have the station list shown.
	Search	Select to search in the active menu. You can search for artists, genres or moods, for example.

#### Additional functions of TuneIn Radio

-  A relatively large volume of data can be transmitted when using TuneIn Radio.

Symbol	Designation	Function
	Settings	The following additional settings are available in the TuneIn Radio menu: <ul style="list-style-type: none"> <li>• Selecting stream</li> <li>• Logging on to or out of the TuneIn account</li> </ul>
	Favorites	Select during playback to save the station currently set as a favorite.
	Play/Pause	Select to start, stop or continue playback.
	Browse	Select to choose a category and then a radio station.



#### Additional functions of the satellite radio

SIRIUS XM<sup>®</sup> satellite radio offers more than 175 digital-quality radio channels providing commercial-free music, sports, news and entertainment, for example. SIRIUS XM<sup>®</sup> satellite radio employs a fleet of high-performance satellites to broadcast

around the clock throughout the USA and Canada. The satellite radio program is available for a monthly fee. Information about this can be obtained from a Sirius XM<sup>®</sup> Service Center and at <https://www.siriusxm.com> (USA).

 Sirius, XM and all related marks and logos are trademarks of Sirius XM Radio Inc. and its subsidiaries. All other marks, channel names

and logos are the property of their respective owners. All rights reserved.

Symbol	Designation	Function
	Settings	The following additional settings are available in the satellite radio menu: <ul style="list-style-type: none"> <li>• Activate child safety lock to lock channels with adult content</li> <li>• Set alarm program for music and sport alerts</li> <li>• Create TuneMix lists to listen to music seamlessly</li> </ul>
	Play	Select to start or continue playback.
	Rest	Select to pause the playback.

Depending on the frequency band selected, different functions are available to you.

Select the desired frequency band in the radio menu head runner.

### Calling up TuneIn Radio

#### Requirements:

- There is a user account at <https://www.mercedes.me>.

- The vehicle is linked to the Mercedes me user account.
- The TuneIn Radio service is activated in the Mercedes me portal.
- The data volume is available.

Depending on the country, data volume may need to be purchased.

- A fast Internet connection for data transmission free of interference.

 New data volume can be purchased **directly from a mobile phone network provider** via the Mercedes me Portal.

 The functions and services are country-dependent. For more information, consult an authorized Mercedes-Benz Center.



Multimedia system:

→  ▶▶ Radio

- ▶ Select **TuneIn Radio**.  
The TuneIn menu appears. The last station set starts playing.
- ⓘ The connection quality depends on the local mobile phone reception.

### Setting up satellite radio

#### Requirements:

- Satellite radio equipment is available.
- Registration with a satellite radio provider has been completed.
- If registration is not included when purchasing the system, your credit card details will be required to activate your account.

Multimedia system:

→  ▶▶  Radio ▶▶ SiriusXM

▶▶ 

- ▶ Select **Service Information**.  
The service information screen appears showing the radio ID and the current subscription status.
- ▶ Establish a telephone connection.
- ▶ Follow the service staff's instructions.  
The activation process may take up to ten minutes.
- ⓘ You can also have the satellite service activated online. To do so, please visit <https://www.siriusxm.com> (USA) or <https://www.siriusxm.ca> (Canada).

### Music and sport alerts

Multimedia system:

→  ▶▶  Radio ▶▶ SiriusXM

▶▶  ▶▶ Alerts

#### Setting music and sport alerts

This function enables you to program an alert for your favorite artists, tracks or sporting events. Music alerts can be saved whilst a track is being played and sport alerts can be saved during a live game. You can also specify sport alerts via the menu option. The system then continuously searches through all the channels.

- ▶ Set a music or sports alert, to be informed of matches in the live program.

#### Activating messages for a category

- ▶ Select a category and activate .

#### Adding messages for a category

- ▶ Select a category and add a message .

- ▶ Select **Artist Alerts** or **Song Alerts** in the dialog window.  
The message is set for the activated  track and artist. If a match is found, a prompt appears asking whether you wish to change to the station.

#### Deleting messages in a category

- ▶ Select a category, mark the desired messages and delete .

or

- ▶ Do not mark any messages and delete all entries .

## Sound settings

### Overview of functions in the sound menu

---

The setting options and functions available depend on the sound system installed. You can find out which sound system is installed in your vehicle in the Digital Operator's Manual.

#### Standard sound system

The following functions are available:

- Equalizer
  - Treble, mid-range and bass
- Balance and fader
- Volume
  - Automatic adjustment

## ASSYST PLUS service interval display

### Function of the ASSYST PLUS service interval display

The ASSYST PLUS service interval display on the driver's display provides information on the remaining time or distance before the next service due date.

You can hide this service display using the  back button on the steering wheel.

Depending on how the vehicle is used, the ASSYST PLUS service interval display may shorten the service interval, e.g. in the following cases:

- Mainly short-distance driving
- When the engine is often left idling for long periods
- In the event of frequent cold start phases

Mercedes-Benz recommends avoiding such operating conditions.

You can obtain information concerning the servicing of your vehicle from a qualified specialist workshop, e.g. an authorized Mercedes-Benz Center.

### Displaying the service due date

Driver's display:



The next service due date is displayed.

▶ **To exit the display:** press the  back button on the steering wheel.

Bear in mind the following related topic:

- Operating the driver's display (→ page 220).

### Information on regular maintenance work

**!** **NOTE** Premature wear through failure to observe service due dates

Maintenance work which is not carried out at the right time or incompletely can lead to increased wear and damage to the vehicle.

- ▶ Adhere to the prescribed service intervals.
- ▶ Always have the prescribed maintenance work carried out at a qualified specialist workshop.

### Notes on special service requirements

The prescribed service interval is based on normal operation of the vehicle. Have the maintenance work carried out more often than prescribed if operating conditions are difficult or the vehicle is subject to increased stress.

The ASSYST PLUS service interval display is only an aid. It is the responsibility of the driver of the vehicle to have maintenance work carried out more often than prescribed due to actual operating conditions and/or stresses.

Examples of arduous operating conditions:

- Regular city driving with frequent intermediate stops
- Mainly short-distance driving
- Frequent operation in mountainous terrain or on poor road surfaces
- When the engine is often left idling for long periods
- Operation in particularly dusty conditions and/or if air-recirculation mode is frequently used

In these or similar operating conditions, have the interior air filter, air filter, engine oil and oil filter, for example, changed more frequently. If subject to increased stress, check the tires more. Further information can be obtained at a qualified specialist workshop.

### Battery disconnection periods

The ASSYST PLUS service interval display can calculate the service due date only when the battery is connected.

- ▶ Display and note down the service due date on the driver display before disconnecting the battery (→ page 273).

## Maintenance Management

### Notes about Maintenance Management

If the Maintenance Management service is activated, relevant data is automatically transferred to the Mercedes-Benz customer center.

The customer center transmits the data to the service partner that you have entered on the

Mercedes me website at: <http://www.mercedes.me>. You will then receive individual recommendations regarding the maintenance of your vehicle.

- ① The calculation of the optimal transmission time of the maintenance request to the service partner is subject to technical limitations that may cause the maintenance recommendation to be perceived as too early or too late or not to be made at all. In this case, you can conveniently arrange a maintenance appointment with the customer center via the maintenance reminder in the multimedia system.
- ① Maintenance Management and the maintenance reminder in the multimedia system are not available in every country. Contact an authorized Mercedes-Benz Center to find out whether this function is available in your country.

### Data transferred when using Maintenance Management

When the service is activated, relevant data is automatically transferred to determine the required scope of maintenance as well as malfunction detection and malfunction rectification.

Details on data transfer can be found in the data protection information for the Mercedes me connect services. These can be found at: <https://www.mercedes.me> under "My Mercedes me account", "Terms of use".

- ① Maintenance Management and the maintenance reminder in the multimedia system are not available in every country.



## Telediagnosis

### Notes about Telediagnosis

- ① This service is not available in all countries. The vehicle can detect if certain wear parts need to be replaced or if malfunctions have occurred in vehicle systems. If the Telediagnosis service is activated, relevant data is automatically transmit-

ted to the manufacturer. If fault conditions are detected by the vehicle system self-diagnosis, the system transmits recommendations for action to the Mercedes-Benz customer center depending on the fault detected. The customer center transmits the data to the service partner that you have entered on the Mercedes me website at: <http://www.mercedes.me>.

For selected faults, the notification that a malfunction has been detected may appear in the multimedia system with a request to contact the Mercedes-Benz customer center. From this message, a call can be made directly to the customer center for assistance.

-  The transmission of a notification to the multimedia system depends on the country, vehicle model and equipment and requires a fast data connection, over which the service provider has no influence.
-  Reliable fault detection is subject to technical limitations. Therefore, only a limited selection of faults can be detected and recommendations for action transmitted to the customer center and the service partners. Mercedes-Benz AG is continuously working on the

expansion of this service. The fault detection depends on the country, vehicle model and equipment.

#### Data transferred when using Telediagnosics

When the service is activated, relevant data is automatically transferred to determine the required scope of maintenance as well as malfunction detection and malfunction rectification.

Details on data transfer can be found in the data protection information for the Mercedes me connect services. These can be found at: <https://www.mercedes.me> under "My Mercedes me account", "Terms of use".



-  The scope of the transmitted data depends on the vehicle model and its equipment. For technical reasons, not all data is available at all times.

### Engine compartment

#### Opening and closing the hood

 **WARNING** Risk of accident due to driving with the hood unlocked

The hood may open and block your view.

-  Never release the hood when driving.
-  Before every trip, ensure that the hood is locked.

 **WARNING** Risk of accident and injury when opening and closing the hood

The hood may suddenly drop into the end position.

There is a risk of injury for anyone in the hood's range of movement.

-  Do not open or close the hood if there is a person in the hood's range of movement.

**⚠ WARNING** Risk of burns when opening the hood

If you open the hood in the event of an overheated engine or fire in the engine compartment, the following situations may occur:

- You may come into contact with hot gases.
  - You may come into contact with other escaping hot operating fluids.
- ▶ Before opening the hood, allow the engine to cool down.
  - ▶ In the event of a fire in the engine compartment, keep the hood closed and call the fire service.

**⚠ WARNING** Risk of injury due to moving parts

Components in the engine compartment may continue to run or start unexpectedly even when the drive system is switched off.

Observe the following if you must open the hood:

- ▶ Switch off the vehicle.
- ▶ Never touch the danger zones surrounding moving components, e.g. the rotation area of the fan.
- ▶ Remove jewellery and watches.
- ▶ Keep items of clothing and hair away from moving parts.

**⚠ WARNING** Risk of injury from touching live components

The ignition system and the fuel injection system operate with a high voltage. You could receive an electric shock.

- ▶ Never touch components of the ignition system or fuel injection system when the vehicle is switched on.

The live components include the following, for example:

- Ignition coils
- Fuel injectors

- Electric lines to the ignition coils and the fuel injectors

**⚠ WARNING** Risk of burns from hot component parts in the engine compartment

Certain component parts in the engine compartment can be very hot, e.g. the engine, the cooler and parts of the exhaust system.

- ▶ Allow the engine to cool down and only touch component parts described in the following.

**⚠ WARNING** Risk of injury from using the windshield wipers when the hood is open

If the windshield wipers start moving when the hood is open, you could be trapped by the wiper linkage.

- ▶ Always switch off the windshield wipers and the vehicle first if you need to open the hood.

### Opening the hood

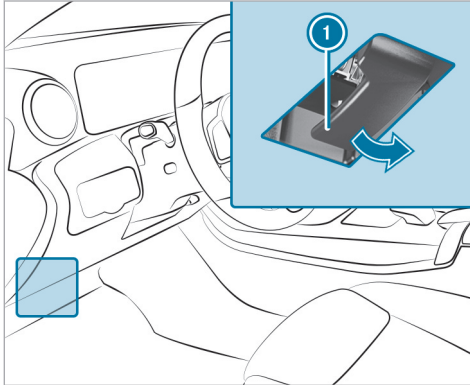

- ▶ To release the hood, pull on handle ①.

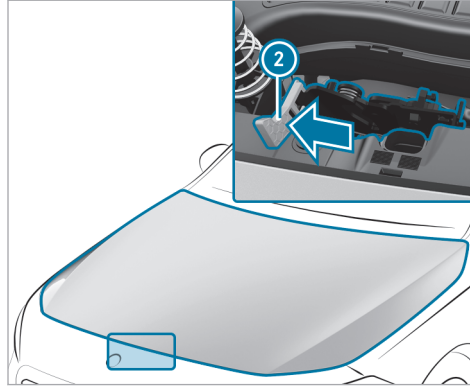

- ▶ Push yellow handle ② on the hood catch to the left as far as it will go (palm downwards). Lift the hood until it is automatically raised by the pneumatic spring.

### Closing the hood

- ▶ Lower the bonnet and let it drop from a height of approximately 8 in (20 cm).

- ▶ If the hood can still be lifted slightly, open the hood again and close it with a little force until it engages correctly.

### Engine oil

#### ■ Checking the engine oil level using the driver's display

##### Requirements

- The engine has been warmed up.
- The vehicle is parked on a level surface.
- The engine is running at idle speed.
- The hood is closed.

Determining the engine oil level can take up to 30 minutes with a normal driving style and even longer with an active driving style.

Driver's display:

↪ [Service](#)

The engine oil level is shown.

One of the following messages will appear on the driver's display:

- **Engine Oil Level Measuring Now...**: the engine oil level cannot be determined yet.
- ▶ Repeat the request after a maximum of 30 minutes' driving.
- **Engine Oil Level OK** and the bar display for indicating the engine oil level on the driver's display is green and is between "min" and "max": the engine oil level is correct.
- **Engine Oil Level Refill 1,0 liq.gal.** and the bar display for indicating the engine oil level on the driver's display is yellow and is below "min":
- ▶ Add 1.1 US qt (1 l) of engine oil.
- **Engine Oil Level Reduce** and the bar display for indicating the engine oil level on the driver's display is yellow and is above "max":
- ▶ Drain off any excess engine oil that has been added. To do so, consult a qualified specialist workshop.
- **For Engine Oil Level Switch on Vehicle**

- ▶ Switch on the vehicle to check the engine oil level.
- **Engine Oil Level System Inoperative:** The oil level sensor is defective or not connected.
- ▶ Consult a qualified specialist workshop.
- **Engine Oil Level System Currently Unavailable**
- ▶ Close the hood.

### ■ Adding engine oil

**⚠ WARNING** Risk of burns from hot component parts in the engine compartment

Certain component parts in the engine compartment can be very hot, e.g. the engine, the cooler and parts of the exhaust system.

- ▶ Allow the engine to cool down and only touch component parts described in the following.

**⚠ WARNING** Risk of fire and injury from engine oil

If engine oil comes into contact with hot component parts in the engine compartment, it may ignite.

- ▶ Make sure that no engine oil is spilled next to the filler opening.
- ▶ Allow the engine to cool off and thoroughly clean the engine oil from component parts before starting the vehicle.

**! NOTE** Engine damage caused by an incorrect oil filter, incorrect oil or additives

- ▶ Do not use engine oils or oil filters which do not correspond to the specifications explicitly prescribed for the service intervals.
- ▶ Follow the instructions on the service interval display for changing the engine oil and observe the prescribed change intervals.
- ▶ Do not use additives.



**!** **NOTE** Damage caused by adding too much engine oil

Excessive engine oil can damage the engine or the catalytic converter.

- ▶ Have excess engine oil removed in a qualified specialist workshop.

**i** Depending on driving style, the vehicle consumes up to 0.9 US qt (0.8 liters) of oil per 600 miles (1,000 km). The oil consumption may also be higher than this when the vehicle is new or if you frequently drive at high engine speeds.

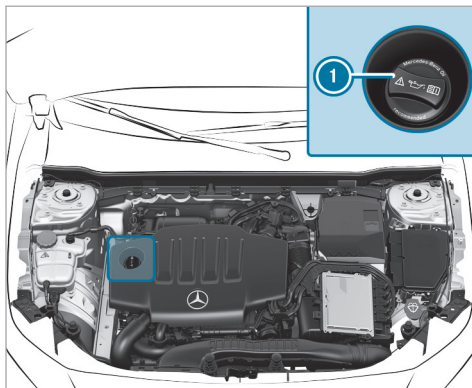

- ▶ Turn cap **1** counter-clockwise and remove it.
- ▶ Add engine oil.
- ▶ Replace cap **1** and turn it clockwise until it engages.
- ▶ Check the oil level again (→ page 277).

### Checking the coolant level

**!** **WARNING** Risk of scalding from hot coolant

If you open the cap, you could scald yourself.

- ▶ Allow the engine to cool down before opening the cap.
- ▶ When opening the cap, wear protective gloves and safety glasses.
- ▶ Open the cap slowly to release pressure.

**!** **WARNING** Risk of burns from hot component parts in the engine compartment

Certain component parts in the engine compartment can be very hot, e.g. the engine, the cooler and parts of the exhaust system.

- ▶ Allow the engine to cool down and only touch component parts described in the following.

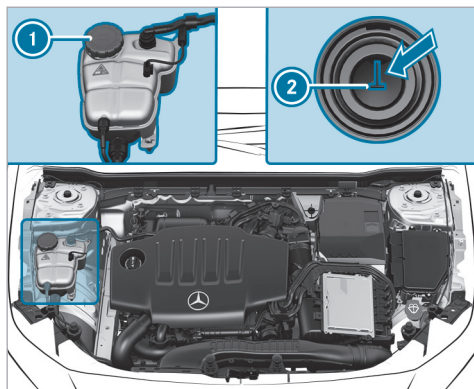

- ▶ Park the vehicle on a level surface.
- ▶ Check the coolant temperature reading in the driver display. The coolant temperature must be in the bottom quarter of the temperature display.
- ▶ Slowly turn the cap ① counter-clockwise to release overpressure.

- ▶ Continue turning the cap ① counter-clockwise and remove it.

The coolant level is correct in the following cases:

- if the engine is cold, the coolant is up to marker bar ②.
- if the engine is warm, the coolant is up to 0.6 in (1.5 cm) over the marker bar ②.
- ▶ If necessary, add coolant that has been approved for Mercedes-Benz.
- ① Further information on coolant (→ page 354).

### Refilling the windshield washer system

- ⚠ **WARNING** Risk of burns from hot component parts in the engine compartment

Certain component parts in the engine compartment can be very hot, e.g. the engine, the cooler and parts of the exhaust system.

- ▶ Allow the engine to cool down and only touch component parts described in the following.

- ⚠ **WARNING** - Risk of fire and injury from windshield washer concentrate

Windshield washer concentrate is highly flammable. It could ignite if it comes into contact with hot engine component parts or the exhaust system.

- ▶ Make sure that no windshield washer concentrate spills out next to the filler opening.

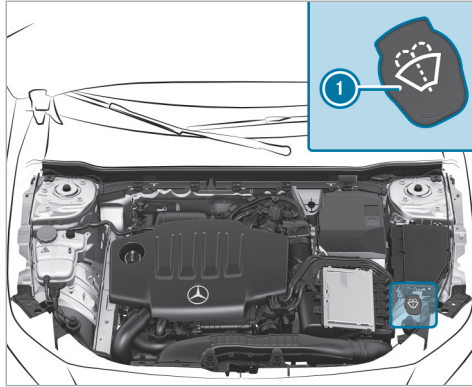

- ▶ Remove cap ① by the tab.
- ▶ Add washer fluid.
- ⓘ Further information about the windshield washer fluid (→ page 355).

### Keeping the air/water duct free

- ▶ Keep the area between the hood and the windshield free of deposits, e.g. ice, snow or leaves.

### Checking the brake lining thickness

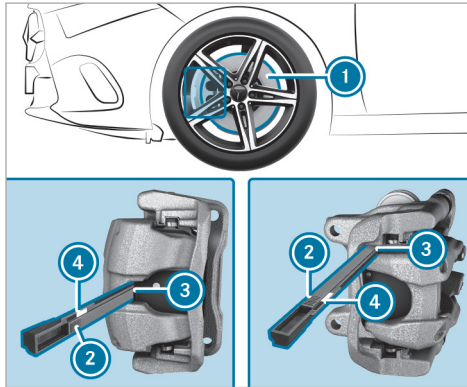

- ▶ Bring the vehicle and wheels into a suitable position so that you can position the gage.
  - ⓘ Measuring point ③ for the test gage depends on the equipment. The gage is positioned at point ③, which is located either in the center of the brake lining or at the upper end to the side, depending on the brake caliper.
  - ▶ Switch off the vehicle.
  - ▶ Secure the vehicle against rolling away.
  - ▶ Take the gage out of the vehicle document wallet in the glove compartment.
  - ▶ Place the test gage between the wheel spokes at measuring point ③ on the brake lining.
  - ▶ Hold the gage vertically to brake disc ① and slide measuring pin ② onto brake disc ①.
  - ▶ Check which color field ④ the arrow on measuring pin ② is pointing to.
- Green:** the brake lining thickness is sufficient.
- Red:** the brake lining thickness is not sufficient. Have the brake linings checked at a qualified specialist workshop.

- i** To avoid an inaccurate measurement:
- Make sure the wheels are suitably positioned.
  - In the case of perforated brake discs, do not put the measuring pin on one of the bores in the brake disc.

### Cleaning and care

#### Information on washing the vehicle in a car wash

**⚠ WARNING** Risk of accident due to reduced braking effect after washing the vehicle

The braking effect is reduced after washing the vehicle.

- ▶ After the vehicle has been washed, brake carefully while paying attention to the traffic conditions until the braking effect has been fully restored.

**! NOTE** Damage from automatic braking

If one of the following functions is activated, the vehicle will brake automatically in certain situations:

- Active Brake Assist
- Active Distance Assist DISTRONIC
- HOLD function
- Active Parking Assist

To avoid damage to the vehicle, switch off these systems, e.g. when towing or using a car wash.

**! NOTE** Damage due to unsuitable car wash

- ▶ Before driving into a car wash make sure that the car wash is suitable for the vehicle dimensions.
- ▶ Ensure there is sufficient ground clearance between the underbody and the guide rails of the car wash.

- ▶ Ensure that the clearance width of the car wash, in particular the width of the guide rails, is sufficient.

To avoid damage to your vehicle when using a car wash, ensure the following beforehand:

- Active Distance Assist DISTRONIC is deactivated.
- the HOLD function is switched off.
- the 360° Camera or the reversing camera is switched off.
- the side windows and sliding sunroof are completely closed.
- the blower for the ventilation and heating is switched off.
- the windshield wiper switch is in position **0**.
- the key is at a minimum distance of 10 ft (3 m) away from the vehicle. Otherwise the trunk lid could open unintentionally.
- for car washes with a conveyor system:
  - Neutral **N** is engaged.

- If you would like to leave the vehicle while it is being washed, make sure the key is located in the vehicle. The park position **P** is otherwise automatically engaged.

**i** If, after the car wash, you remove the wax from the windshield and wiper rubbers, this will prevent smearing and reduce wiper noise.

### Car wash mode

In car wash mode, the vehicle is prepared for driving into an automatic car wash. Car wash mode can be activated up to a speed of 12 mph (20 km/h) (→ page 283).

The following settings are made when car wash mode is activated:

- The outside mirrors are folded in.
- To prevent the windshield washer system from starting automatically, the rain sensor is deactivated.
- Air-recirculation mode is activated.
- Parking Assist PARKTRONIC is deactivated.

- **Vehicles with 360° camera:** The front image is activated after approximately eight seconds.

If one of the settings cannot be made, this is displayed by a **X** behind the respective setting.

Car wash mode is automatically deactivated above a speed of 12 mph (20 km/h).

The following settings are reversed when car wash mode is deactivated:

- The outside mirrors are folded out.
- The rain sensor is activated.
- Air-recirculation mode is deactivated.
- Parking Assist PARKTRONIC is restored to the previously selected setting.
- **Vehicles with 360° camera:** The front image is deactivated at speeds above 11 mph (18 km/h).

### Activating/deactivating car wash mode



#### Requirements

- The vehicle is stationary.
- The vehicle is switched on.

Multimedia system:

  **» Settings » Vehicle » Driving**

#### Activating automatic car wash mode

-  Select **Automatic Car Wash Mode**.
-  Select **Activate**.

If one of the settings cannot be selected, this is shown by a **X** next to the respective setting.

**i** For an overview of the settings made when activating automatic car wash mode (→ page 282).

#### Deactivating automatic car wash mode

-  Select **Switch Off**.  
The automatic car wash settings are reset.
- i** Car wash mode is automatically deactivated as soon as a speed of 12 mph (20 km/h) is exceeded.

### Information on using a power washer

#### **⚠ WARNING** Risk of an accident when using power washers with round-spray nozzles

The water jet can cause externally invisible damage.

Components damaged in this way may unexpectedly fail.

- ▶ Do not use a power washer with round-spray nozzles.
- ▶ Have damaged tires or chassis parts replaced immediately.

To avoid damage to your vehicle when using a power washer, ensure the following:

- the key is at a minimum distance of 10 ft (3 m) away from the vehicle. Otherwise the trunk lid could open unintentionally.
- Keep a minimum distance of 11.8 in (30 cm) from the vehicle.
- **Vehicles with decorative foil:** parts of your vehicle are covered with decorative foil. Maintain a minimum distance of 27.6 in (70 cm)

between the foiled parts of the vehicle and the power washer nozzle. Move the power washer nozzle around when cleaning your vehicle. The water temperature of the power washer must not exceed 140°F (60°C).

- Observe the information on the correct distance in the operating instructions of the equipment manufacturer.
- Do not direct the nozzle of the power washer directly at sensitive parts, e.g. tires, gaps, electrical component parts, batteries, illuminants or louvers.

### Washing the vehicle by hand

#### **!** NOTE Engine damage due to water ingress

- ▶ Take care not to point the water jet directly towards the air inlet grille below the hood.

Observe the relevant legal requirements (e.g. in some countries, washing by hand is permitted only in specially designated wash bays).

- ▶ Use a mild cleaning agent (e.g. car shampoo).
- ▶ Do not use an acidic cleaning agent.
- ▶ Wash the vehicle with lukewarm water using a soft car sponge. When doing so, do not expose the vehicle to direct sunlight.
- ▶ Carefully hose the vehicle off with water and dry using a chamois.
- ⓘ Observe the notes on the care of car parts (→ page 286).

### Notes on paintwork/matte finish paintwork care

To avoid damaging the paintwork and interfering with the driving assistance systems, please observe the following notes:

#### Paint

- Insect remains: soak with insect remover and rinse off the treated areas afterwards.
- Bird droppings: soak with water and rinse off afterwards.
- Tree resin, oils, fuels and greases: remove by rubbing gently with a cloth soaked in petroleum ether or lighter fluid.

- Coolant and brake fluid: remove with a damp cloth and clean water.
- Tar stains: use tar remover.
- Wax: use silicone remover.
- Do not attach stickers, films or similar materials. Only have film attached to the bumper at a qualified specialist workshop.
- Remove dirt immediately, where possible. Do not use acidic solutions and acidic cleaning agents.

#### Matte finish

- Only use care products approved for Mercedes-Benz.
- Do not attach stickers, films or similar materials. Only have film attached to the bumper at a qualified specialist workshop.
- Do not polish the vehicle or the light-alloy wheels.
- Only use car washes that correspond to the latest engineering standards.
- Do not use a car wash program with a final hot wax treatment.

- Do not use paint cleaners, buffing or polishing products, gloss preservers, e.g. wax.

In the event of paintwork damage:

- Always have paintwork repairs carried out at a qualified specialist workshop.
- Make sure the radar sensors function (→ page 167).

#### Notes on cleaning decorative films

Observe the "Notes on paintwork /matte finish paintwork care" (→ page 284). They also apply to matte decorative films.

Observe the notes on cleaning decorative films to avoid damage.

#### Cleaning

- For cleaning, use plenty of water and a mild cleaning agent without additives or abrasive substances (e.g. a car shampoo approved for Mercedes-Benz).
- Do not use an acidic cleaning agent.

- Remove dirt as soon as possible. Avoid rubbing too hard in order not to damage the decorative film irreparably.
- If there is dirt on the finish or if the decorative film is dull: use the paint cleaner recommended and approved for Mercedes-Benz.
- Insect remains: soak with insect remover and rinse off the treated areas afterwards.
- Bird droppings: soak with water and rinse off afterwards.
- To prevent water stains, dry a film-wrapped vehicle with a soft, absorbent cloth after every car wash.

#### Avoiding damage to the decorative film

- The service life and color of decorative films are impaired by:
  - Sunlight
  - Temperature (e.g. hot air blower)
  - Weather conditions
  - Stone chippings and dirt
  - Chemical cleaning agents
  - Oily products

- Do not use polish on matte decorative film. Polishing will have the effect of shining the film-wrapped surface.
- Do not treat matte or structured decorative films with wax. Permanent stains may occur.

Scratches, corrosive deposits, areas affected by corrosion and damage caused by incorrect care cannot always be completely repaired. In this case, contact a qualified specialist workshop.

You can obtain more information on care and cleaning agents from the manufacturer.

In the case of film-wrapped surfaces, visual differences may occur between the surfaces that were not protected by a decorative film after a decorative film has been removed.

- ① Have work or repairs to decorative films carried out at a qualified specialist workshop (e.g. at an authorized Mercedes-Benz Center).

### Notes on cleaning and care of vehicle parts

**⚠ WARNING** Risk of entrapment if the windshield wipers are switched on while the windshield is being cleaned

If the windshield wipers are set in motion while you are cleaning the windshield or wiper blades, you can be trapped by the wiper arm.

- ▶ Always switch off the windshield wipers and the vehicle before cleaning the windshield or wiper blades.

**! NOTE** Damage caused by acidic cleaning agents

- ▶ Do not use acidic cleaning agents. Otherwise, the surfaces could be damaged.

To avoid damage to the vehicle, observe the notes on cleaning and care of the following car parts:

#### Wheels and rims

- Use water and acid-free alloy wheel cleaners.

- Do not use acidic alloy wheel cleaners to remove brake dust. This could damage wheel bolts and brake components.
- To avoid corrosion of the brake discs and pads, drive the vehicle for a few minutes after cleaning before parking it. The brake discs and pads will warm up and dry out.

#### Windows

**! NOTE** Damage to electronic components due to excess fluids

When cleaning the windows from the inside, fluids such as cleaning agents or water may run down and get behind trim parts of the vehicle interior and cause damage to electronic components.

- ▶ Use cleaning agents as sparingly as possible.
- ▶ Immediately absorb any excess fluids.

- Clean the windows inside and outside with a damp cloth and with a cleaning agent recommended for Mercedes-Benz.



- Do not use dry cloths or abrasive or solvent-based cleaning agents to clean the insides of windows.
- ⓘ After changing the wiper blades or treating the vehicle with wax, clean the windshield thoroughly with cleaning agents recommended for Mercedes-Benz. Failure to observe the application instructions may result in damage, smear marks or glare spots.
- ⓘ Remove external fogging or dirt on the windshield in front of the multifunction camera. Otherwise, driving systems and driving safety systems may be impaired or not available (→ page 167).

#### Wiper blades

- Move the wiper arms into the replacement position (→ page 126).
- With the wiper arms folded out, clean the wiper blades with a damp cloth.
- ⓘ Make sure that the wiper blades are coated. The coating may leave residue on a cloth. Do not rub the wiper blades excessively or clean them too often.

#### Exterior lighting

- Clean the lenses with a wet sponge and mild cleaning agent (e.g. car shampoo).
- Use only cleaning agents or cleaning cloths that are suitable for plastic lenses.

#### Sensors

- Clean the sensors in the front and rear part of the vehicles with car shampoo, plenty of water and a soft cloth (→ page 167).
- When using a power washer, maintain a minimum distance of 11.8 in (30 cm).

#### Cameras

- Open the camera cover with the multimedia system (→ page 208).
- Use clean water and a soft cloth to clean the camera lenses.
- Do not use a power washer.
- ⓘ Remove external fogging or dirt on the windshield in front of the multifunction camera. Otherwise, driving systems and driving safety systems may be impaired or not available (→ page 167).

#### Notes on care of the interior

**⚠ WARNING** Risk of injury from plastic parts breaking off after the use of solvent-based care products

Care and cleaning products containing solvents can cause surfaces in the cockpit to become porous. When the airbags are deployed, plastic parts may break away.

- ▶ Do not use any care or cleaning products containing solvents to clean the cockpit.

**⚠ WARNING** Risk of injury or fatal injuries from bleached seat belts

Bleaching or dyeing seat belts can severely weaken them.

This can, for example, cause seat belts to tear or fail in an accident.

- ▶ Never bleach or dye seat belts.

**!** **NOTE** Property damage due to disinfectants

The interior includes a number of sensitive surfaces such as displays, plastics and leather.

Disinfectants can contain alcohol and other substances that penetrate and damage surfaces. Technology behind buttons and displays can also be damaged.

▶ Do not use disinfectant on interior surfaces.

To avoid damage to the vehicle, observe the following notes on cleaning and care:

#### Seat belts

- Clean with lukewarm and soapy water.
- Do not use chemical cleaning agents.
- Do not dry by heating them to over 176°F (80°C) or exposing them to direct sunlight.

#### Display

- Switch off the display and let it cool down.

- Clean the surface carefully with a microfiber cloth and a suitable display care product (TFT-LCD).
- Do not use any other agents.

#### Head-up display

- Clean with a soft, non-static, lint-free cloth.
- Do not use cleaning agents.

#### Plastic trim

- Clean with a damp microfiber cloth.
- For heavy soiling: Use a cleaner recommended for Mercedes-Benz.
- Do not attach stickers, films or similar materials.
- Do not allow cosmetics, insect repellent or sun cream to come in contact with the plastic trim.

#### Real wood and trim elements

- Clean with a microfiber cloth.
- Black piano-lacquer look: clean with a damp cloth and soapy water.

- For heavy soiling: Use a cleaner recommended for Mercedes-Benz.
- Do not use solvent-based cleaning agents, polishes or waxes.

#### Headliner

- Clean with a brush or dry shampoo.

#### Carpet

- Use a carpet and textile cleaning agent recommended for Mercedes-Benz.

#### Steering wheels made of imitation leather

- Use a damp cotton cloth and a 1% soap solution to clean the entire steering wheel. Do not spot clean.
- Use cleaning and care products recommended for Mercedes-Benz.
- Do not use a microfiber cloth.
- Do not use oil-based cleaning and care products.

## Steering wheel made of genuine leather or DINAMICA

### ! NOTE Damage caused by wrong cleaners

▶ Do not use solvent-based cleaning agents such as tar remover or wheel cleaner; neither should you use polishes or waxes. Otherwise you may damage the finish.

- Clean with a damp cloth and a 1% soapy water solution and then wipe with a dry cloth.
  - For heavy soiling: Use a cleaner recommended for Mercedes-Benz.
  - Leather care: Use a leather care agent that has been recommended for Mercedes-Benz.
  - Do not allow the leather to become too damp.
  - Do not use a microfiber cloth.
- ① Leather is a natural product. It has natural surface properties, such as differences in structure, marks caused by growth and injury or subtle color differences. These surface properties are characteristics of leather and

not material defects. Leather is also subject to a natural aging process during which the surface properties change.

### Genuine leather seat covers

- Vacuum up dirt such as crumbs or dust and then clean the seat covers with a damp cotton cloth and wipe down with a dry cloth. Regularly clean the seat covers.
- For heavy soiling: use a leather care agent recommended for Mercedes-Benz aftercare.
- Leather care: Use a leather care agent that has been recommended for Mercedes-Benz.
- Do not use a microfiber cloth.
- Do not allow the leather to become too damp.
- Do not use oil-based cleaning and care products.

① Leather is a natural product. It has natural surface properties, such as differences in structure, marks caused by growth and injury or subtle color differences. These surface properties are characteristics of leather and not material defects. Leather is also subject

to a natural aging process during which the surface properties change.

Waves or wrinkling in the seat cover may occur due to the stress on the seat; this is caused by the natural leather material. Regular cleaning and care of the leather reduces soiling, wear marks and aging damage and thus significantly extends its life span. Clothing that can leave stains (e.g. jeans) may discolor the leather.

### DINAMICA seat covers

- Vacuum up dirt such as crumbs or dust and then use a damp cloth to clean.
- Do not use a microfiber cloth.

### Imitation leather seat covers

- Vacuum up dirt such as crumbs or dust and then use a damp cotton cloth and a 1% soap solution to clean the entire seat cover. Do not spot clean.
- Use cleaning and care products recommended for Mercedes-Benz.
- Do not use a microfiber cloth.

## 290 Maintenance and care

---

- Do not use oil-based cleaning and care products.

### **Cloth seat covers**

- Vacuum up dirt such as crumbs or dust and then use a damp microfiber cloth and a 1% soap solution to clean the entire seat cover. Do not spot clean.
- Use cleaning and care products recommended for Mercedes-Benz.
- Do not use oil-based cleaning and care products.

## Emergency

## Removing the safety vest

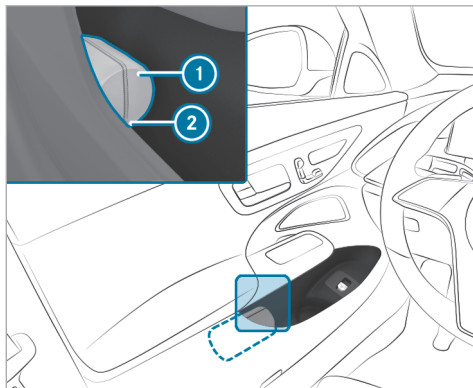

There is a safety vest compartment in the storage compartments of all doors for storing a safety vest.

- ▶ To remove: pull out safety vest bag ① by loop ②.

- ▶ Open safety vest bag ① and pull out the safety vest.
- ▶ To stow: fold the reflective safety jacket, roll it up and stow it in safety jacket bag ①.
- ▶ Slide safety jacket bag ① along the lower edge of the armrest into the safety jacket compartment. Meanwhile, ensure that loop ② hangs out well within reach.

- ① Remove a new reflective safety jacket from its packaging material before sliding it into the safety jacket compartment. The packaging material may otherwise cause it to slip out or make removing it difficult. Observe the legal requirements in each country.

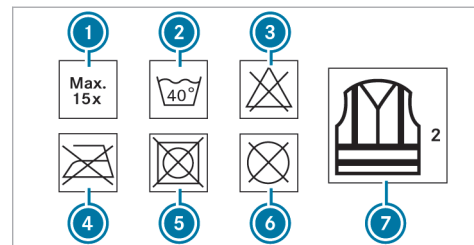

- ① Maximum number of washes
- ② Maximum wash temperature
- ③ Do not bleach
- ④ Do not iron
- ⑤ Do not tumble dry
- ⑥ Do not dry clean
- ⑦ Class 2 safety vest

The requirements defined by the legal standard are only fulfilled if the safety vest is the correct size and is fully closed.

Replace the safety vest in the following cases:

- The reflective strips are damaged or dirty

- The maximum permissible number of washes is exceeded
- The fluorescence has faded, e.g. due to continuous exposure to sunlight.

Dispose of the safety vest in an environmentally responsible manner:

- To do so, contact your local waste disposal company.

### Warning triangle

#### Removing the warning triangle

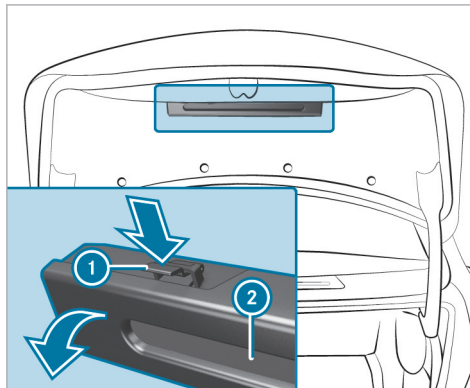

- ▶ Push both sides of warning triangle holder ① in the direction of the arrow and open it.
- ▶ Remove warning triangle ②.

#### Setting up the warning triangle

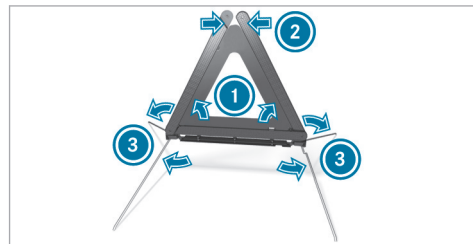

- ▶ Fold side reflectors ① upwards to form a triangle and attach at the top using upper press-stud ②.
- ▶ Fold legs ③ down and out to the side.

### First-aid kit (soft-sided) overview

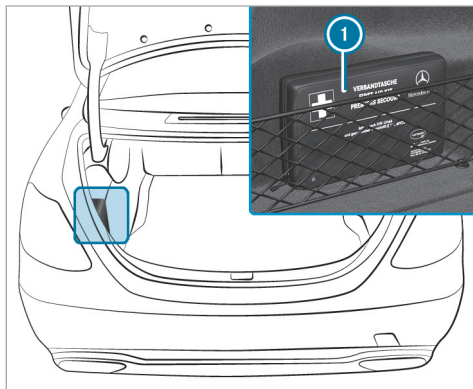

Depending on the vehicle version, first-aid kit (soft-sided) ① is located in the stowage net on the left-hand side of the trunk or under the trunk floor.

### Flat tire

#### Notes on flat tires

**⚠ WARNING** Risk of accident due to a flat tire

A flat tire severely affects the driving characteristics as well as steering and braking.

#### Tires without run-flat characteristics:

- ▶ Do not drive on with a flat tire.
- ▶ Change the flat tire immediately with an emergency spare wheel or spare wheel. Alternatively, consult a qualified specialist workshop.

#### Tires with run-flat characteristics:

- ▶ Observe the information and warning notes on MOExtended tires (run-flat tires).

In the event of a flat tire, you have the following options depending on your vehicle's equipment:

- **Vehicles with MOExtended tires:** it is possible to continue your journey for a short period of

time. Make sure you observe the notes on MOExtended tires (run-flat tires) (→ page 294).

- **Vehicles with a TIREFIT kit:** you can seal the tire so that it is possible to continue your journey for a short period of time. To do this, use the TIREFIT kit (→ page 295).
  - **Vehicles with Mercedes me connect:** you can make a call for breakdown assistance via the overhead control panel in the case of a breakdown (→ page 255).
  - **All vehicles:** change the wheel (→ page 338).
- ① The emergency spare wheel is available only in certain countries (→ page 343). Vehicles equipped with MOExtended tires are not equipped with a TIREFIT kit at the factory. It is therefore recommended that you additionally equip your vehicle with a TIREFIT kit if you mount tires on your vehicle that do not feature run-flat characteristics, e.g. winter tires. A TIREFIT kit may be obtained from a qualified specialist workshop.

**Vehicles with a Mercedes-Benz emergency call system that are not equipped with a TIREFIT kit:** in the event of a flat tire, contact the Customer Assistance Center for the Mercedes-Benz emergency call system .

### Notes on MOExtended tires (run-flat tires)

**⚠ WARNING** Risk of accident when driving in limp-home mode

When driving in emergency mode the handling characteristics are impaired.

- ▶ Do not exceed the specified maximum speed of the MOExtended tires.
- ▶ Avoid any abrupt steering and driving maneuvers as well as driving over obstacles (curbs, pot holes, off-road). This applies, in particular, to a loaded vehicle.
- ▶ Stop driving in the emergency mode if you notice:
  - Banging noise
  - Vehicle vibration

- Smoke which smells like rubber
- Continuous ESP® intervention
- Cracks in the tire side walls

- ▶ After driving in emergency mode, have the rims checked by a qualified specialist workshop with regard to their further use.
- ▶ The defective tire must be replaced in every case.

With MOExtended tires (run-flat tires), you can continue to drive your vehicle even if there is a total loss of pressure in one or more tires. However, the tire affected must not show any clearly visible damage.

You can recognize MOExtended tires by the MOExtended marking which appears on the side wall of the tire.

**Vehicles with tire pressure loss warning system:** MOExtended tires may only be used in conjunction with an activated tire pressure loss warning system.

**Vehicles with tire pressure monitoring system:** MOExtended tires may only be used in conjunction with an activated tire pressure monitoring system.

If a pressure loss warning message appears in the driver's display, proceed as follows:

- Check the tire for damage.
- If driving on, observe the following notes.

**Driving distance possible in emergency mode after the pressure loss warning:**

Load condition	Driving distance possible in emergency mode
Partially laden	50 miles (80 km)
Fully laden	19 miles (30 km)

The driving distance possible in emergency mode may vary depending on the driving style. Observe the maximum permissible speed of 50 mph (80 km/h).



If a tire has gone flat and cannot be replaced with an MOExtended tire, you can use a standard tire as a temporary measure.

### TIREFIT kit storage location

The TIREFIT kit is located under the trunk floor.

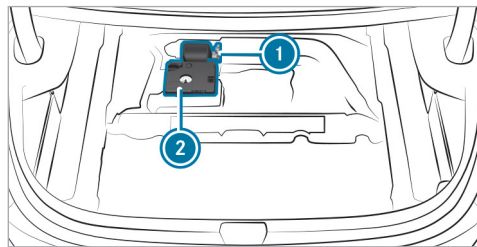

- ① Tire sealant bottle
- ② Tire inflation compressor

Depending on the vehicle version, the TIREFIT kit may also be located in other positions under the trunk floor.

### Using the TIREFIT kit

#### Requirements

- Tire sealant bottle and tire inflator compressor are ready for use (→ page 295).
- TIREFIT sticker is present.
- Gloves are present.

You can use TIREFIT tire sealant to seal perforation damage of up to 0.16 in (4 mm), particularly those in the tire tread. You can use TIREFIT in outside temperatures down to -4 °F (-20 °C).

#### ⚠ WARNING Risk of accident when using tire sealant

The tire sealant may be unable to seal the tire properly, especially in the following cases:

- There are large cuts or punctures in the tire (larger than damage previously mentioned)
- The wheel rims have been damaged
- After journeys with very low tire pressure or with flat tires

- ▶ Do not continue driving.
- ▶ Consult a qualified specialist workshop.

#### ⚠ WARNING Risk of injury and poisoning from tire sealant

The tire sealant is harmful and causes irritation. Do not allow it to come into contact with the skin, eyes or clothing, and do not swallow it. Do not inhale tire sealant fumes. Keep the tire sealant away from children.

If you come into contact with the tire sealant, observe the following:

- ▶ Rinse off the tire sealant from your skin immediately using water.
- ▶ If tire sealant gets into your eyes, thoroughly rinse out the eyes using clean water.
- ▶ If tire sealant has been swallowed, immediately rinse out the mouth thoroughly and drink plenty of water. Do not induce vomiting and seek medical attention immediately.

- ▶ Change out of any clothes contaminated with tire sealant immediately.
- ▶ If allergic reactions occur, seek medical attention immediately.

**!** **NOTE** Overheating due to the tire inflation compressor running too long

- ▶ Do not run the tire inflation compressor for longer than ten minutes without interruption.

Comply with the manufacturer's safety notes on the sticker on the tire inflation compressor.

Have the tire sealant bottle replaced in a qualified specialist workshop every five years.

- ▶ Do not remove any foreign objects that have entered the tire.

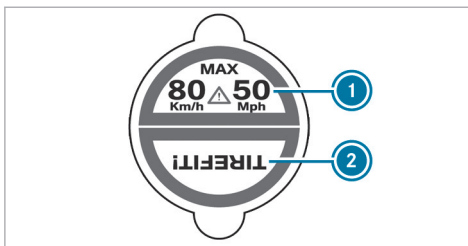

- ▶ Affix part ① of the TIREFIT sticker to the instrument cluster within the driver's field of vision.
- ▶ Affix part ② of the TIREFIT sticker near the valve on the wheel with the defective tire.

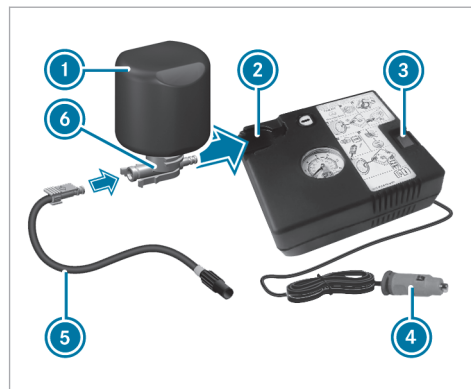

- ▶ Pull plug ④ with the cable and hose ⑤ out of the tire inflation compressor housing.
- ▶ Push the plug of hose ⑤ into flange ⑥ of tire sealant bottle ① until the plug engages.
- ▶ Place tire sealant bottle ① head downwards into recess ② of the tire inflation compressor.

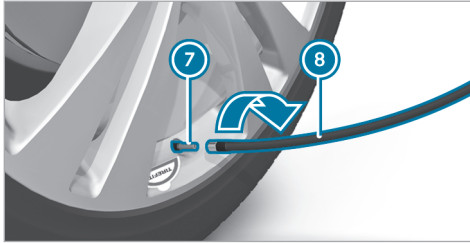

- ▶ Remove the valve cap from valve ⑦ on the faulty tire.
- ▶ Screw filling hose ⑧ onto valve ⑦.
- ▶ Insert plug ④ into a 12-V-socket in your vehicle.
- ▶ Switch on the vehicle.
- ▶ Switch on the tire inflation compressor using On/Off switch ③.  
The tire is inflated. First, tire sealant is pumped into the tire. The pressure may briefly rise to approximately 500 kPa (5.0 bar/73 psi).

**Do not switch off the tire inflation compressor during this phase!**

- ▶ Let the tire inflation compressor run for a maximum of ten minutes.  
The tire should then have attained a tire pressure of at least 200 kPa (2.0 bar/29 psi).

If tire sealant leaks out, make sure you clean the affected area as quickly as possible. It is preferable to use clean water.

If you get tire sealant on your clothing, have it cleaned as soon as possible with perchloroethylene.

**If, after ten minutes, a tire pressure of 200 kPa (2.0 bar/29 psi) has not been attained:**

- ▶ Switch off the tire inflation compressor.
- ▶ Unscrew the filling hose from the valve of the defective tire.

Please note that tire sealant may leak out when unscrewing the filling hose.

- ▶ Drive forwards or in reverse very slowly for approximately 33 ft (10 m).

- ▶ Pump up the tire again.  
After a maximum of ten minutes the tire pressure must be at least 200 kPa (2.0 bar/29 psi).

**⚠ WARNING** Risk of accident due to the specified tire pressure not being achieved

If the specified tire pressure is not achieved after the specified time, the tire is too badly damaged. The tire sealant cannot repair the tire in this instance.

The braking characteristics as well as the driving characteristics may be greatly impaired.

- ▶ Do not continue driving.
- ▶ Consult a qualified specialist workshop.

**If, after ten minutes, a tire pressure of 200 kPa (2.0 bar/29 psi) has been attained:**

- ▶ Switch off the tire inflation compressor.
- ▶ Unscrew the filling hose from the valve of the defective tire.

**⚠ WARNING** Risk of accident from driving with sealed tires

A tire temporarily sealed with tire sealant impairs the handling characteristics and is not suitable for higher speeds.

- ▶ Adapt your driving style accordingly and drive carefully.
- ▶ Do not exceed the maximum speed limit with a tire that has been repaired using tire sealant.

- ▶ Observe the maximum permissible speed of 50 mph (80 km/h) for a tire sealed with tire sealant.

**! NOTE** Staining caused by leaking tire sealant

After use, excess tire sealant may leak out from the filling hose.

- ▶ Therefore, place the filling hose in the plastic bag that contained the TIREFIT kit.

**🔥 ENVIRONMENTAL NOTE** Environmental pollution caused by environmentally irresponsible disposal

Tire sealant contains pollutants.

- ▶ Have the tire sealant bottle disposed of professionally, e.g. at an authorized Mercedes-Benz Center.

- ▶ Stow the tire sealant bottle and the tire inflation compressor.
- ▶ Pull away immediately.
- ▶ Stop driving after approximately ten minutes and check the tire pressure using the tire inflation compressor. The tire pressure must now be at least 130 kPa (1.3 bar/19 psi).

**⚠ WARNING** Risk of accident due to the specified tire pressure not being attained

If the specified tire pressure is not reached, the tire is too badly damaged. The tire sealant cannot repair the tire in this instance.

The braking and driving characteristics may be greatly impaired.

- ▶ Do not continue driving.
- ▶ Consult a qualified specialist workshop.

In cases such as the one mentioned above, contact an authorized Mercedes-Benz Center. Or call 1-800-FOR-MERCEdes (in the USA) or 1-800-387-0100 (in Canada).

- ▶ **To increase the tire pressure:** switch on the tire inflation compressor.

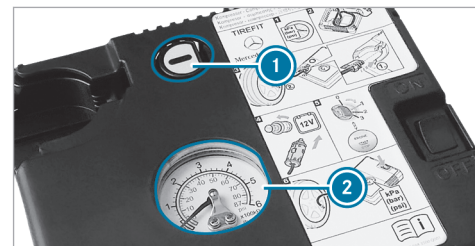

- ▶ **To reduce the tire pressure:** press pressure release button ① next to manometer ②.

- ▶ When the tire pressure is correct, unscrew the filling hose from the valve of the sealed tire.
- ▶ Screw the valve cap onto the valve of the sealed tire.
- ▶ Pull the tire sealant bottle out of the tire inflation compressor.  
The filling hose stays on the tire sealant bottle.
- ▶ Drive to the nearest qualified specialist workshop and have the tire, tire sealant bottle and filling hose replaced there.

### Battery (vehicle)

#### Notes on the 12 V battery

- ▲ **WARNING** Risk of an accident due to work carried out incorrectly on the battery

Work carried out incorrectly on the battery can, for example, lead to a short circuit. This can restrict functions relevant for safety systems and impair the operating safety of your vehicle.

You could lose control of the vehicle in the following situations in particular:

- When braking
- In the event of abrupt steering maneuvers and/or when the vehicle's speed is not adapted to the road conditions
- ▶ In the event of a short circuit or a similar incident, contact a qualified specialist workshop immediately.
- ▶ Do not drive on.
- ▶ Always have work on the battery carried out at a qualified specialist workshop.

- Further information on ABS (→ page 169)
- Further information on ESP® (→ page 170)

For safety reasons, Mercedes-Benz recommends that you only use batteries which have been approved for your vehicle by Mercedes-Benz.

#### All vehicles except vehicles with a lithium-ion battery

- ▲ **WARNING** Risk of explosion due to electrostatic charge

Electrostatic charge can ignite the highly explosive gas mixture in the battery.

- ▶ To discharge any electrostatic charge that may have built up, touch the metal vehicle body before handling the battery.

The highly flammable gas mixture is created while the battery is charging and during starting assistance.

- ▲ **WARNING** Danger of chemical burns from the battery acid

Battery acid is caustic.

- ▶ Avoid contact with the skin, eyes or clothing.
- ▶ Do not lean over the battery.
- ▶ Do not inhale battery gases.

- ▶ Keep children away from the battery.
- ▶ Immediately rinse battery acid off thoroughly with plenty of clean water and seek medical attention immediately.

### All vehicles

 **ENVIRONMENTAL NOTE** Environmental damage due to improper disposal of batteries



Batteries contain pollutants. It is illegal to dispose of them with the household rubbish.



▶ Dispose of batteries in an environmentally responsible manner. Take discharged batteries to a qualified specialist workshop or to a collection point for used batteries.

If you have to disconnect the 12 V battery, contact a qualified specialist workshop.

Comply with safety notes and take protective measures when handling batteries.



Risk of explosion if the 12 V battery is used improperly.



Fire, naked flames and smoking are prohibited when handling the battery. Avoid creating sparks.



Electrolyte or battery acid is corrosive. Avoid contact with the skin, eyes or clothing. Wear suitable protective clothing, in particular gloves, an apron and a face mask. Immediately rinse electrolyte or acid splashes off with clean water. Consult a doctor immediately.



Do not place heavy objects on the surface of the battery or use the battery to support a person in any way.



Wear safety glasses.



Keep children away.



Observe this Operator's Manual.

Observe the following if you do not intend to use the vehicle over an extended period of time:

- **If available:** activate standby mode (→ page 167, 166).
- Alternatively: connect the battery to a battery charger approved by Mercedes-Benz or consult a qualified specialist workshop to disconnect the battery.

### Notes on the 48 V battery



**WARNING** Risk of an accident due to work carried out incorrectly on the battery

Work carried out incorrectly on the battery can, for example, lead to a short circuit. This can restrict functions relevant for safety sys-

tems and impair the operating safety of your vehicle.

You could lose control of the vehicle in the following situations in particular:

- When braking
- In the event of abrupt steering maneuvers and/or when the vehicle's speed is not adapted to the road conditions
- ▶ In the event of a short circuit or a similar incident, contact a qualified specialist workshop immediately.
- ▶ Do not drive on.
- ▶ Always have work on the battery carried out at a qualified specialist workshop.

- Further information on ABS (→ page 169)
- Further information on ESP® (→ page 170)



**ENVIRONMENTAL NOTE** Environmental damage due to improper disposal of batteries



Batteries contain pollutants. It is illegal to dispose of them with the household trash.



**Li-ion** Dispose of batteries in an environmentally responsible manner. Take discharged batteries to a qualified specialist workshop or to a collection point for used batteries.

Have any work on the 48 V battery carried out exclusively at a qualified specialist workshop.

Comply with safety notes and take protective measures when handling batteries.



Risk of explosion if the 48 V battery is used improperly.



The surface of the 48 V battery may be hot.



Fire, naked flames and smoking are prohibited when handling the battery. Avoid creating sparks.



Electrolyte or battery acid is corrosive. Avoid contact with the skin, eyes or clothing. Wear suitable protective clothing, in particular gloves, an apron and a face mask. Immediately rinse off splashes of electrolyte or acid with plenty of clean water. Consult a doctor immediately.



Do not place heavy objects on the surface of the battery or use the battery to support a person in any way.



Do not perform any work on the battery. Always have any work on the battery carried out at a qualified specialist workshop. Do not disconnect the battery yourself. Do not remove the battery yourself. Do not attempt to open the battery.



Keep children away.



Wear safety glasses.



Observe this Operator's Manual.

Observe the following if you do not intend to use the vehicle over an extended period of time:

- **If available:** activate standby mode (→ page 167, 166).

### Notes on starting assistance and charging the 12 V battery

#### All vehicles

When charging the battery and during starting assistance, always use the jump-start connection point in the engine compartment.

**!** **NOTE** Damage to the battery due to over-voltage

When charging using a battery charger without a maximum charging voltage, the battery or the on-board electronics may be damaged.

- ▶ Only use battery chargers with a maximum charging voltage of 14.8 V.

**!** **WARNING** Risk of explosion due to igniting hydrogen gas

If you cause a short circuit or sparks occur, the hydrogen gas may ignite when a battery is charging.

- ▶ Ensure that the positive terminal of a connected battery does not come into contact with vehicle parts.
- ▶ Never place metal objects or tools on a battery.
- ▶ When connecting and disconnecting the battery, always observe the sequence of battery terminals described.
- ▶ When jump starting, take care to connect only battery terminals of identical polarity.
- ▶ When jump starting, always observe the sequence described for connecting and disconnecting the jumper cables.
- ▶ Do not connect or disconnect the battery terminals when the engine is running.

**!** **WARNING** Risk of explosion due to a mixture of explosive gases

A mixture of explosive gases can escape from the battery during charging and jump starting.

- ▶ Fire, open flames, smoking and creating sparks must be avoided.
- ▶ Make sure that there is sufficient ventilation.
- ▶ Do not stand over the battery.

**!** **WARNING** Risk of explosion from a frozen battery

A discharged battery may freeze at temperatures slightly above or below freezing point.

During starting assistance or battery charging, battery gas can be released.

- ▶ Always allow a battery to thaw before charging it or performing starting assistance.

If, at low temperatures, the indicator lamps/warning lamps in the instrument cluster do not light up, it is highly likely that the discharged battery



has frozen. In this case, you may neither charge the battery nor jump-start the vehicle.

The service life of a battery that has been thawed may be drastically reduced. The starting characteristics can be impaired, particularly at low temperatures.

We recommend having the thawed-out battery inspected at a qualified specialist workshop.

#### All vehicles

**!** **NOTE** Damage caused by numerous or extended attempts to start the engine

Numerous or extended attempts to start the engine may damage the catalytic converter due to non-combusted fuel.

▶ Avoid numerous and extended attempts to start the engine.

Observe the following points during starting assistance and when charging the battery:

- Use only undamaged jumper cables / charging cables with a sufficient cross-section and insulated terminal clamps.

- Non-insulated parts of the terminal clamps must not come into contact with other metal parts while the jumper cable / charging cable is connected to the battery / jump-start connection point.
- The jumper cables / charging cables must not come into contact with any parts that may move when the engine is running
- Always make sure that neither you nor the battery is electrostatically charged.
- Keep away from fire and open flames.
- Do not lean over a battery.

Also observe the following points when charging the battery:

- Use only chargers tested and approved for Mercedes-Benz.
- Read the operating instructions for the charger before charging the battery.

Also observe the following points during starting assistance:

- Starting assistance may only be provided using vehicles, batteries or other jump start devices with a nominal voltage of 12 V.
- The vehicles must not touch each other.
- **Vehicles with a gasoline engine:** only jump-start your vehicle when the engine and exhaust system are cold.

#### Starting assistance and charging the 12 V battery

##### Preparing for starting assistance / the charging process

- ▶ Secure the vehicle by applying the electric parking brake.
- ▶ Shift the transmission to position **P**.
- ▶ Switch off the vehicle and all electrical consumers.
- ▶ Open the hood.

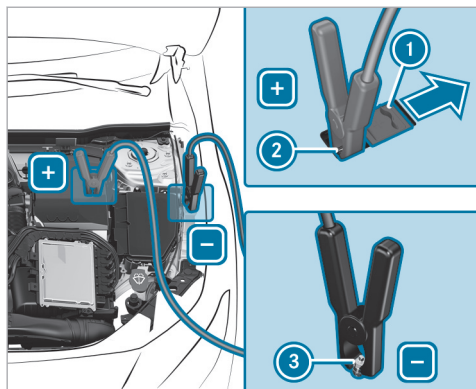

- ▶ Slide cover ① of positive contact ② on the jump-start connection point in the direction of the arrow.

### Starting assistance

- ▶ Connect the positive contact of your vehicle to the jumper cable.
- ▶ Connect the positive terminal of the donor battery to the jumper cable.

- ▶ Start the engine of the donor vehicle and run it at idling speed.
- ▶ Connect the negative terminal of the donor battery to the jumper cable.
- ▶ Connect ground point ③ of your vehicle to the jumper cable.
- ▶ Start the engine of your own vehicle.
- ▶ Let the engines run for several minutes.
- ▶ Before disconnecting the jumper cables, switch on an electrical consumer in your own vehicle (e.g. the rear window defroster or the lighting).

When the starting assistance procedure is complete:

- ▶ Disconnect the jumper cable from ground point ③ of your vehicle.
- ▶ Disconnect the jumper cable from the negative terminal of the donor battery.
- ▶ Disconnect the jumper cable from the positive contact of your vehicle.
- ▶ Disconnect the jumper cable from the positive terminal of the donor battery.

- ▶ Close cover ① of positive contact ② after removing the jumper cables.

Further information can be obtained at a qualified specialist workshop.

### Charging the 12 V battery

- ▶ Connect the positive contact of your vehicle to the charging cable.
- ▶ Connect the positive terminal of the charger to the charging cable.
- ▶ Connect the negative terminal of the charger to the charging cable.
- ▶ Connect ground point ③ of your vehicle to the charging cable.
- ▶ Start the charging process.

When the charging process is complete:

- ▶ Disconnect the charging cable from ground point ③ of your vehicle.
- ▶ Disconnect the charging cable from the negative terminal of the charger.
- ▶ Disconnect the charging cable from positive contact of your vehicle.

- ▶ Disconnect the charging cable from the positive terminal of the charger.
- ▶ After removing the charging cable, close cover ① of positive contact ②.

### Replacing the 12 V battery

- ▶ Observe the notes on the 12 V battery (→ page 299).

Mercedes-Benz recommends that you have the 12 V battery replaced at a qualified specialist workshop, e.g. at an authorized Mercedes-Benz Center.

Observe the following notes if you want to replace the battery yourself:

- Always replace a faulty battery with a battery that meets the specific vehicle requirements.

The vehicle is equipped with an AGM (Absorbent Glass Mat) technology battery or a lithium-ion battery. Full vehicle functionality is guaranteed only with an AGM or lithium-ion battery. For safety reasons, Mercedes-Benz recommends that you use only batteries that have

been tested and approved for your vehicle by Mercedes-Benz.

- Use detachable parts such as vent hoses, elbow fittings or terminal covers from the battery to be replaced.
- Make sure that the vent hose is always connected to the original opening on the side of the battery.  
Install any existing or supplied cell caps. Otherwise, gases or battery acid could escape.
- Make sure that detachable parts are reconnected in the same way.

### Tow starting or towing away

#### Overview of permitted towing methods (not plug-in hybrid)

#### ! NOTE Damage from automatic braking

If one of the following functions is activated, the vehicle will brake automatically in certain situations:

- Active Brake Assist
- Active Distance Assist DISTRONIC
- HOLD function
- Active Parking Assist

To avoid damage to the vehicle, switch off these systems, e.g. when towing or using a car wash.

Mercedes-Benz recommends transporting your vehicle in the case of a breakdown, rather than towing it away.

For towing with both axles on the ground, use a tow rope or tow rod. Do not use tow bar systems.

**⚠ WARNING** Risk of accident when towing with steering wheel locking



When the steering wheel locking is engaged, you can no longer steer the vehicle.

▶ Always switch on the vehicle when towing with a tow rope or tow bar.

**! NOTE** Damage to the vehicle due to towing away incorrectly

▶ Observe the instructions and notes on towing away.

### Permitted towing methods

Vehicle equipment/towing method	 Both axles on the ground	 Front axle raised	 Rear axle raised
Vehicles with automatic transmission	Yes, for a maximum of 31 miles (50 km) at 31 mph (50 km/h)	Yes, for a maximum of 31 miles (50 km) at 31 mph (50 km/h)	Yes, for a maximum of 31 miles (50 km) at 31 mph (50 km/h)
4MATIC vehicles	Yes, for a maximum of 31 miles (50 km) at 31 mph (50 km/h)	No	No

**Towing with a raised axle:** towing should be performed by a towing company.

#### Towing the vehicle with both axles on the ground

▶ Observe the notes on the permitted towing methods.

▶ Make sure that the battery is connected and charged.

Observe the following points when the battery is discharged:

- the vehicle cannot be started.
- the electric parking brake cannot be released or applied
- **Vehicles with automatic transmission:** the transmission cannot be shifted to position **N** or **P**.

**i** **Vehicles with automatic transmission:** if the transmission cannot be shifted to position **N** or if the display does not show anything, transport the vehicle (→ page 308). A towing vehicle with lifting equipment is required for vehicle transportation.

**!** **NOTE** Damage due to towing away at excessively high speeds or over long distances

The drivetrain could be damaged when towing at excessively high speeds or over long distances.

- ▶ A towing speed of 30 mph (50 km/h) must not be exceeded.
- ▶ A towing distance of 30 miles (50 km) must not be exceeded.

**!** **WARNING** Risk of accident when towing a vehicle which is too heavy

If the vehicle to be tow-started or towed away is heavier than the permissible gross mass of your vehicle, the following situations can occur:

- The towing eye may become detached.
  - The vehicle/trailer combination may swerve or rollover.
- ▶ Before tow-starting or towing away, check if the vehicle to be tow-started or towed away exceeds the permissible gross mass.

If a vehicle has to be tow-started or towed away, its permissible gross mass must not exceed the permissible gross mass of the towing vehicle.

- ▶ Information on the permissible gross mass of the vehicle can be found on the vehicle identification plate (→ page 348).
- ▶ **Vehicles with automatic transmission:** do not open the driver's door or front passenger door; the transmission otherwise automatically shifts to position **P**.
- ▶ Install the towing eye (→ page 309).
- ▶ Fasten the towing device.

**!** **NOTE** Damage due to incorrect connection of the tow bar

- ▶ Only connect the tow rope or tow bar to the towing eyes.

- ▶ Deactivate the automatic locking mechanism (→ page 76).
- ▶ Do not activate the HOLD function.
- ▶ Deactivate the tow-away alarm (→ page 90).
- ▶ Deactivate Active Brake Assist (→ page 192).
- ▶ **Vehicles with automatic transmission:** shift to position **N**.
- ▶ Release the electric parking brake.

**⚠ WARNING** Risk of accident due to limited safety-related functions during the towing process

Safety-related functions are limited or no longer available in the following situations:

- The vehicle is switched off.
- The brake system or power steering system is malfunctioning.
- The energy supply or the on-board electrical system is malfunctioning.

When your vehicle is towed away, significantly more effort may be required to steer and brake than is normally required.

- ▶ Use a tow bar.
- ▶ Make sure that the steering wheel can move freely before towing the vehicle away.

**! NOTE** Damage due to excessive tractive power

If you pull away sharply, the tractive power may be too high and the vehicles could be damaged.

- ▶ Pull away slowly and smoothly.

### Loading the vehicle for transport

- ▶ Observe the notes on towing away (→ page 306).
- ▶ Connect the towing device to the towing eye in order to load the vehicle.
- ▶ **Vehicles with automatic transmission:** shift the automatic transmission to position **N**.
- i** **Vehicles with automatic transmission:** the automatic transmission may be locked in position **P** in the event of damage to the electrical system. To shift to **N**, provide the on-board electrical system with power (→ page 303).
- ▶ Load the vehicle onto the transporter.

- ▶ **Vehicles with automatic transmission:** shift the automatic transmission to position **P**.
- ▶ Use the electric parking brake to secure the vehicle against rolling away.
- ▶ Only secure the vehicle by the wheels.

### Vehicles with adaptive damping adjustment

**⚠ WARNING** Risk of an accident when transporting vehicles with adaptive damping adjustment

When transporting vehicles with adaptive damping adjustment, the vehicle/trailer combination may begin to rock and start to skid.

- ▶ Load the vehicle correctly onto the transporter.
- ▶ Secure the vehicle on all four wheels with suitable tensioning straps.

**!** **NOTE** Damage to the vehicle from securing it incorrectly

- ▶ After loading, the vehicle must be secured on all four wheels. Otherwise, the vehicle could be damaged.
- ▶ A minimum distance of 8 in (20 cm) upwards and 4 in (10 cm) downwards must be kept to the transport platform.

- ▶ Secure the vehicle at all four wheels after loading.

#### 4MATIC vehicles/vehicles with automatic transmission

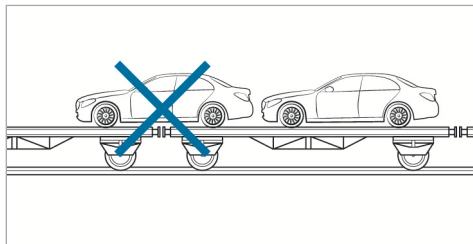

- ▶ Make sure that the front and rear axles come to rest on the same transportation vehicle.

**!** **NOTE** Damage to the drive train due to incorrect positioning of the vehicle

- ▶ Do not position the vehicle above the connection point of the transport vehicle.

#### Towing eye storage location

The towing eye is located under the trunk floor.

- ① Depending on the vehicle version, the towing eye may be located in a different position in the trunk.

#### Installing and removing the towing eye

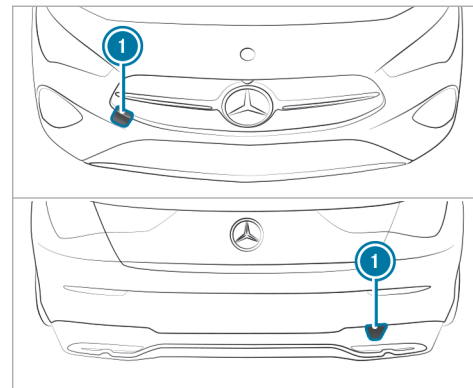

- ▶ Press the mark on cover ① inwards and remove.
- ▶ Screw in the towing eye clockwise as far as it will go and tighten.
- ▶ After removing the towing eye, engage cover ① in the bumper.

**!** **NOTE** Damage to the vehicle due to incorrect use of the towing eye or trailer hitch

When a towing eye or trailer hitch is used to recover a vehicle, the vehicle may be damaged in the process.

- ▶ Only use the towing eye or trailer hitch to tow away or tow start the vehicle.
- ▶ Do not use the towing eye or trailer hitch to tow the vehicle during recovery.

### Tow-starting the vehicle

#### Vehicles with automatic transmission

**!** **NOTE** Damage to the automatic transmission due to tow starting

The automatic transmission may be damaged in the process of tow starting vehicles with automatic transmission.

- ▶ Vehicles with automatic transmission must not be tow started.

- ▶ Vehicles with automatic transmissions must not be tow-started.

### Electrical fuses

#### Notes on electrical fuses

**!** **WARNING** Risk of accident and injury due to overloaded lines

If you manipulate or bridge a faulty fuse or if you replace it with a fuse with a higher amperage, the electric line could be overloaded.

This could result in a fire.

- ▶ Always replace faulty fuses with specified new fuses containing the correct amperage.

**!** **NOTE** Damage due to incorrect fuses

Using incorrect fuses can result in damage to electrical components or systems or their functions being considerably restricted.

- ▶ Use only fuses approved for Mercedes-Benz with the respective specified fuse rating.

Blown fuses must be replaced with fuses of the same rating, which you can recognize by the color and the label. The fuse ratings and further information to be observed can be found in the fuse assignment diagram.

**Fuse assignment diagram:** on the fuse box in the engine compartment (→ page 311).

**!** **NOTE** Damage or malfunctions caused by moisture

Moisture may cause damage to the electrical system or cause it to malfunction.

- ▶ When the fuse box is open, make sure that no moisture can enter the fuse box.
- ▶ When closing the fuse box, make sure that the seal of the lid is positioned correctly on the fuse box.



If the newly inserted fuse also blows, have the cause traced and rectified at a qualified specialist workshop.

Ensure the following before replacing a fuse:

- The vehicle is secured against rolling away.
- All electrical consumers are switched off.
- The vehicle is switched off.

The fuses are located in various fuse boxes:

- Fuse box in the engine compartment on the left-hand side of the vehicle, when viewed in the direction of travel (→ page 311)
- Fuse box in the front-passenger footwell (→ page 312)
- Fuse box in the center of the trunk (→ page 313)

### Opening and closing the fuse box in the engine compartment

#### Requirements:

- A dry cloth and a screwdriver are available.

Observe the notes on electrical fuses (→ page 310).

#### Opening

**⚠ WARNING** Risk of injury from using the windshield wipers when the hood is open

If the windshield wipers start moving when the hood is open, you could be trapped by the wiper linkage.

- ▶ Always switch off the windshield wipers and vehicle before opening the hood.

- ▶ Open the hood.

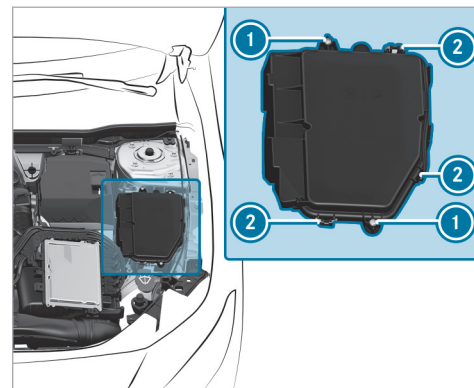

- ▶ Remove any existing moisture from the fuse box using a dry cloth.
- ▶ Loosen screws ①.
- ▶ Press clips ② and lift the fuse box lid up and out.

The fuse assignment diagram is in a recess on the side of the fuse box.

### Closing

- ▶ Check whether the seal is positioned correctly in the lid.
- ▶ Place the lid on the fuse box.
- ▶ Make sure that clips ② engage.
- ▶ Tighten screws ①.
- ▶ Close the hood.

### Opening and closing the fuse box in the front passenger footwell

#### Requirements

Observe the notes on electrical fuses  
(→ page 310).

### Opening

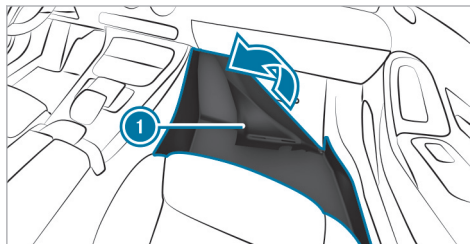

- ▶ Lift carpet ① in the direction of the arrow.

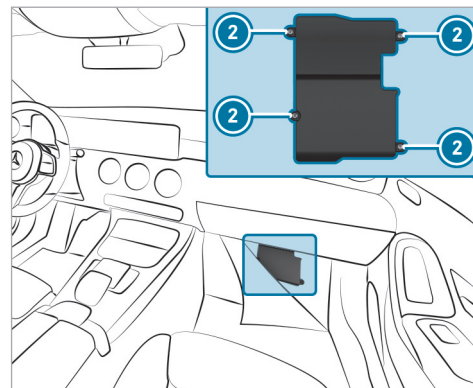

- ▶ Loosen screws ② and remove fuse box lid from the top.

### Closing

- ▶ Place the lid on the fuse box.
- ▶ Tighten screws ②.
- ▶ Fold back the carpet.

### Opening and closing the fuse box in the trunk

#### Requirements

Observe the notes on electrical fuses  
(→ page 310).

- ▶ Open the trunk floor .

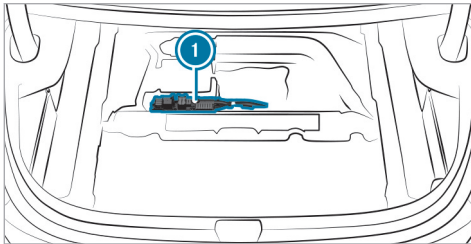

Fuse box ① is located in the center underneath the trunk floor.

### Notes on noise or unusual handling characteristics

Make sure there are no vibrations, noises or unusual handling characteristics when the vehicle is in motion. This may indicate that the wheels or tires are damaged. Hidden tire damage could also be causing the unusual handling characteristics.

If you suspect that a tire is defective, reduce your speed immediately and have the tires and wheels checked at a qualified specialist workshop.

### Notes on regularly inspecting wheels and tires

#### **⚠ WARNING** Risk of injury through damaged tires

Damaged tires can cause tire pressure loss.

- ▶ Check the tires regularly for signs of damage and replace any damaged tires immediately.

#### **⚠ WARNING** Risk of hydroplaning due to insufficient tire tread

Insufficient tire tread will result in reduced tire grip.

In heavy rain or slush the risk of hydroplaning is increased, in particular where speed is not adapted to suit the conditions.

- ▶ Thus, you should regularly check the tread depth and the condition of the tread across the entire width of all tires.

Minimum tread depth for:

- Summer tires:  $\frac{1}{8}$  in (3 mm)
- M+S tires:  $\frac{1}{6}$  in (4 mm)

- ▶ For safety reasons, replace the tires before the legally-prescribed limit for the minimum tread depth is reached.

Carry out the following checks on all wheels regularly, at least once a month or as required, for example, prior to a long journey or driving off-road:

- Check the tire pressure (→ page 315).

- Visually inspect wheels and tires for damage.
- Check the valve caps.
- Visually inspect the tire tread depth and the tire contact surface across the entire width.  
The minimum tread depth for summer tires is  $\frac{1}{8}$  in (3 mm) and for winter tires  $\frac{1}{6}$  in (4 mm).

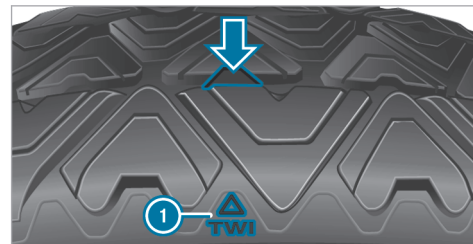

Six marks ① show where the bar indicators (arrow) are integrated into the tire tread. They are visible once a tire tread depth of approximately  $\frac{1}{16}$  in (1.6 mm) has been reached.

### Notes on snow chains

**⚠ WARNING** Risk of accident due to incorrectly installed snow chains

If you have installed snow chains to the rear wheels, they may drag against the vehicle body or chassis components.

- ▶ Never install snow chains on the rear wheels.
- ▶ Only install snow chains on the front wheels in pairs.

**! NOTE** Damage to vehicle body or suspension components caused by installed snow chains

On 4MATIC vehicles, if you install snow chains on the rear wheels, you can damage vehicle body or suspension components.

- ▶ On 4MATIC vehicles, only install snow chains on the front wheels.

Observe the following notes when using snow chains:

- Snow chains are only permissible for certain wheel/tyre combinations. You can obtain information about this from a Mercedes-Benz Service Centre.
  - For safety reasons, only use snow chains that have been specifically approved for your vehicle by Mercedes-Benz, or snow chains with the same quality standard.
  - If snow chains are fitted, the maximum permissible speed is 30 mph (50 km/h).
  - **Vehicles with Active Parking Assist:** do not use Active Parking Assist when snow chains are fitted.
- i** You can deactivate ESP® to start off (→ page 171). This allows the wheels to spin, achieving an increased driving force.

### Tire pressure

#### Notes on tire pressure

**⚠ WARNING** Risk of accident due to insufficient or excessive tire pressure

Underinflated or overinflated tires pose in particular the following risks:

- The tires can burst.
  - The tires can wear excessively and/or unevenly.
  - The driving characteristics as well as the steering and braking characteristics may be greatly impaired.
- ▶ Comply with the recommended tire pressures and check the tire pressure of all tires, including the spare wheel, regularly:
- Monthly
  - When the load changes
  - Before embarking on a longer journey

- If operating conditions change, e.g. off-road driving
- ▶ Adjust the tire pressure, if necessary.

Tire pressure which is too high or too low can:

- Shorten the service life of the tires.
- Cause increased tire damage.
- Adversely affect driving characteristics and thus driving safety, e.g. due to hydroplaning.

**⚠ WARNING** Risk of accident due to too low a tire pressure

Tires with pressure that is too low can overheat and burst as a consequence.

In addition, they also suffer from irregular wear, which can significantly impair the braking properties and the handling characteristics.

- ▶ Avoid excessively low tire pressure.

Tire pressure which is too low can cause:

- Tire defects as a result of overheating

- Impaired handling characteristics
- Irregular wear
- Increased fuel consumption

**⚠ WARNING** Risk of accident due to too high a tire pressure

Tires with excessively high pressure can burst. In addition, they also suffer from irregular wear, which can significantly impair the braking properties and the handling characteristics.

- ▶ Avoid excessively high tire pressures.

Tire pressure which is too high can cause:

- Increased braking distance
- Impaired handling characteristics
- Irregular wear
- Impaired driving comfort
- Susceptibility to damage

**⚠ WARNING** Risk of accident due to repeated pressure drop in the tires

The wheels, valves or tires could be damaged. Too low a tire pressure can lead to the tires bursting.

- ▶ Examine the tires for foreign objects.
- ▶ Check whether the tire has a puncture or the valve has a leak.
- ▶ If you are unable to rectify the damage, contact a qualified specialist workshop.

You can find information on the recommended tire pressures for the vehicle's factory-installed tires on the following labels:

- Tire and Loading Information placard on the B-pillar of your vehicle (→ page 322).
- Tire pressure table on the inside of the fuel filler flap (→ page 317).

Observe the maximum tire pressure (→ page 329).

Use a suitable pressure gauge to check the tire pressure. The outer appearance of a tire does not

permit any reliable conclusion about the tire pressure.

Only correct tire pressure when the tires are cold. Conditions for cold tires:

- The vehicle has been parked with the tires out of direct sunlight for at least three hours.
- The vehicle has traveled less than 1 mile (1.6 km).

The vehicle's tires heat up when driving. As the temperature of the tires increases, so too does the tire pressure.

**Vehicles with a tire pressure monitoring system:** you can also see the tire pressure in the driver's display (→ page 319).

The tire pressure recommended for increased load/speed in the tire pressure table can affect the ride comfort.

**⚠ WARNING** Risk of accident due to unsuitable accessories on tire valves

If you mount unsuitable accessories onto tire valves, the tire valves may be overloaded and

malfunction, which can cause tire pressure loss.

- ▶ Only screw standard valve caps or valve caps specifically approved by Mercedes-Benz for your vehicle onto the tire valve.

### Tire pressure table

The tire pressure table is on the inside of the fuel filler flap.

- ⓘ The data shown in the images is example data.

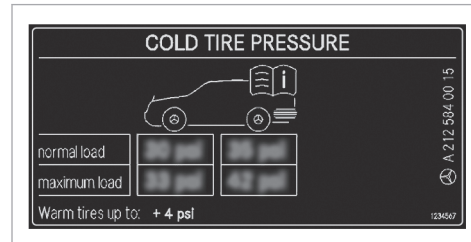

The tire pressure table shows the recommended tire pressure for all tires approved for this vehicle. The recommended tire pressure apply for cold tires under various operating conditions, i.e. loading and/or speed of the vehicle.

If one or more tire sizes precede a tire pressure, the following tire pressure information is only valid for those tire sizes and their respective load condition.

The load conditions "partially laden" and "fully laden" are defined in the table for different numbers of passengers and amounts of luggage. The actual number of seats may differ from this.

		kPa	psi	kPa	psi
R18	[Tread icon]	[Grid]	[Grid]	[Grid]	[Grid]
R19	[Tread icon]	[Grid]	[Grid]	[Grid]	[Grid]
M+S	[Tread icon]	[Grid]	[Grid]	[Grid]	[Grid]

Some tire pressure tables only show the rim diameter instead of the complete tire size, e.g. **R18**. The rim diameter is part of the tire size and can be found on the tire side wall (→ page 329).

- Tire and Loading Information placard (→ page 322)
- Maximum tire pressures (→ page 329)

### Checking the tire pressure manually

- ▶ Read the tire pressure recommended for the current operating conditions from the tire and loading information placard or the tire pressure table. Observe the notes on tire pressure.
- ▶ Remove the valve cap of the tire to be checked.
- ▶ Press the tire pressure gauge securely onto the valve.
- ▶ Read the tire pressure.
- ▶ If the tire pressure is lower than the recommended value, increase the tire pressure to the recommended value.
- ▶ If the tire pressure is higher than the recommended value, release air. To do so, press down the metal pin in the valve, e.g. using the tip of a pen. Then check the tire pressure again using the tire pressure gauge.
- ▶ Screw the valve cap onto the valve.

Further related subjects:

- Notes on tire pressure (→ page 315)
- Tire pressure table (→ page 317)

- Tire and loading information placard (→ page 322)

### Tire pressure monitoring system

#### Function of the tire pressure monitor

**⚠ DANGER** Risk of accident due to incorrect tire pressure

Each tire, including the spare (if provided), should be checked monthly when cold and inflated to the inflation pressure recommended by the vehicle manufacturer on the vehicle placard or tire inflation pressure label. (If your vehicle has tires of a different size than the size indicated on the vehicle placard or tire inflation pressure label, you should determine the proper tire inflation pressure for those tires.)

As an added safety feature, your vehicle has been equipped with a tire pressure monitoring system (TPMS) that illuminates a low tire pressure telltale when one or more of your tires is significantly under-inflated. Accordingly, when



the low tire pressure telltale illuminates, you should stop and check your tires as soon as possible, and inflate them to the proper pressure. Driving on a significantly under-inflated tire causes the tire to overheat and can lead to tire failure. Under-inflation also reduces fuel efficiency and tire tread life, and may affect the vehicle's handling and stopping ability. Please note that the TPMS is not a substitute for proper tire maintenance, and it is the driver's responsibility to maintain correct tire pressure, even if under-inflation has not reached the level to trigger illumination of the TPMS low tire pressure telltale.

Your vehicle has also been equipped with a TPMS malfunction indicator to indicate when the system is not operating properly. The TPMS malfunction indicator is combined with the low tire pressure telltale. When the system detects a malfunction, the telltale will flash for approximately one minute and then remain continuously illuminated. This sequence will continue upon subsequent vehicle start-ups as long as the malfunction exists.

When the malfunction indicator is illuminated, the system may not be able to detect or signal low tire pressure as intended. TPMS malfunctions may occur for a variety of reasons, including the installation of replacement or alternate tires or wheels on the vehicle that prevent the TPMS from functioning properly.

The system uses a tire pressure sensor to check the pressure and temperature of the tires fitted on the vehicle.

The tire pressure and tire temperature appear on the driver's display.

If there is a substantial pressure loss or if the tire temperature is excessive, you will be warned with display messages (→ page 403) or the  warning lamp on the driver's display (→ page 427).

The tire pressure monitor is only an aid. It is the driver's responsibility to set the tire pressure to the recommended cold tire pressure suitable for the operating situation.

In most cases, the tire pressure monitor will automatically update the new reference values after you have changed the tire pressure. You can, however, also update the reference values by restarting the tire pressure monitor manually (→ page 320).

### System limits

The system may be impaired or may not function particularly in the following situations:

- incorrect reference values were taught in
- sudden pressure loss caused by a foreign object penetrating the tire, for example
- there is a malfunction caused by another radio signal source

### ■ Checking the tire pressure with the tire pressure monitoring system

#### Requirements

- The vehicle is switched on.

Driver's display:

   Service

 Press  to confirm.

One of the following displays appears:

- Current tire pressure of each wheel:



- **Tire pressure displayed after driving for a few minutes.:** current values are not yet known to the system. The pressure/temperature values of each tire will be displayed as soon as they are known to the system.
  - **Tire Pressure Monitor Active:** the teach-in process of the system is not yet complete. The tire pressures are already being monitored.
- ▶ Compare the current tire pressure with the recommended tire pressure for the current

operating mode (→ page 317). Additionally, observe the notes on cold tires (→ page 315).

- ⓘ The values displayed on the driver's display may deviate from those of the tire pressure gauge as they refer to sea level. At high elevations, the tire pressure values indicated by a tire pressure gauge will be higher than those shown on the driver's display.

Bear in mind the following related topic:

- Notes on tire pressure (→ page 315)

### Restarting the tire pressure monitoring system

#### Requirements

- The recommended tire pressure is correctly set for the respective operating condition on each of the four wheels (→ page 315).

Restart the tire pressure monitoring system in the following situations:

- The tire pressure has changed.
- The wheels or tires have been changed or newly installed.

Driver's display:



- ▶ Select **Tire Pressure** and press **OK** to confirm.
- ▶ Swipe downwards on Touch Control on the steering wheel.  
The **Use current pressures as new reference values?** message is shown on the driver's display.
- ▶ Select **Yes** and confirm the restart with **OK**.  
The **Tire Pressure Monitor Restarted** message is shown on the driver's display.  
Current warning messages are deleted and the  yellow warning lamp goes out.  
After driving for a few minutes, the system checks whether the current tire pressures are within the specified range. The current tire pressures are then accepted as reference values and monitored.  
If the tire pressure levels are not within the specified range, the **Please Correct Tire Pressure** message appears.

Bear in mind the following related topic:

- Notes on tire pressure (→ page 315)

### Tire pressure loss warning system

#### ■ Function of the tire pressure loss warning system

The tire pressure loss warning system warns the driver by means of display messages when there is a severe tire pressure loss.

#### System limits

The system may be impaired or may not function particularly in the following situations:

- incorrect reference values were taught in
- sudden pressure loss caused by a foreign object penetrating the tire, for example
- an even pressure loss on more than one tire occurs

The system has a restricted or delayed function particularly in the following situations:

- poor ground conditions, e.g. snow or gravel

- driving with snow chains
- when adopting a very sporty driving style with high cornering speeds or sudden acceleration
- driving with a high load

The tire pressure loss warning system is only an aid. It is the driver's responsibility to set the tire pressure to the recommended cold tire pressure suitable for the operating situation and to check it.

Be sure to also observe the following further related subjects:

- Notes on tire pressure (→ page 315)
- Display messages about the tires (→ page 403)

#### ■ Restarting the tire pressure loss warning system

##### Requirements

- The recommended tire pressure is correctly set for the respective operating condition at each of the four wheels (→ page 315).

Restart the tire pressure loss warning system in the following situations:

- The tire pressure has changed.
- The wheels or tires have been changed or newly installed.

Driver's display:

→  » Service

- ▶ Select **Tire Pressure** and press  to confirm.  
The **Run Flat Indicator Active** message will be shown on the driver's display.
- ▶ To initiate a restart, press  on the steering wheel.  
The **Are the current pressure values OK?** message will be shown on the driver's display.
- ▶ Select **Yes**.
- ▶ To confirm the restart, press  on the steering wheel.  
The **Run Flat Indicator Restarted** message will be shown on the driver's display.

## 322 Wheels and tires

Be sure to also observe the following further related subjects:

- Notes on tire pressure (→ page 315)

### Loading the vehicle

#### Notes on the Tire and Loading Information placard

**⚠ WARNING** Risk of accident from overloaded tires

Overloaded tires may overheat and burst as a consequence. Overloaded tires can also impair the steering and handling characteristics and lead to brake failure.

- ▶ Observe the load rating of the tires.
- ▶ The load rating must be at least half the permissible axle load of the vehicle.
- ▶ Never overload the tires by exceeding the maximum load.

The Tire and Loading Information placard is on the B-pillar on the driver's side of the vehicle.

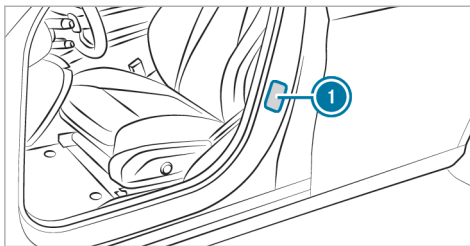

① Tire and Loading Information placard

TIRE AND LOADING INFORMATION			
RENSEIGNEMENTS SUR LES PNEUS ET LE CHARGEMENT			
SEATING CAPACITY NOMBRE DE PLACES	TOTAL 7 FRONT AVANT 2 MIDDLE 3 REAR ARRIERE 2		
The combined weight of occupants and cargo should never exceed XXX kg or XXX lbs. Le poids total des occupants et du chargement ne doit jamais dépasser XXX kg ou XXX lbs.			
TIRE PNEU	SIZE DIMENSIONS	COLD TIRE PRESSURE PRESSION DES PNEUS À FROID	SEE OWNER'S MANUAL FOR ADDITIONAL INFORMATION
FRONT AVANT	255/40 ZR18 99Y XL	200 KPA, 29 PSI	VOIR LE MANUEL DE L'USAGER POUR PLUS DE RENSEIGNEMENTS
REAR ARRIÈRE	285/35 ZR18 101Y XL	200 KPA, 29 PSI	
SPARE DE SECOURS	175/55-18 95P	420 KPA, 60 PSI	

ⓘ The data shown in the illustration is example data.

The Tire and Loading Information placard shows the following information:

- Maximum number of seats ② according to the maximum number of people permitted to travel in the vehicle.

- Maximum permissible load ③ comprises the gross weight of all vehicle occupants, load and luggage.
- Recommended tire pressures ① for cold tires. The recommended tire pressures are valid for the maximum permissible load and up to the maximum permissible vehicle speed.

Please also note:

- Information on permissible weights and loads on the vehicle identification plate (→ page 348).
- Information on tire pressure on the tire pressure table (→ page 317).

Further related subjects:

- Determining the maximum permissible load (→ page 323)
- Notes on tire pressure (→ page 315)

### Steps for determining the correct load limit

The following steps were developed according to the regulations of Title 49, Code of U.S. Federal

Regulations, Part 575, which are binding on all manufacturers, and the National Traffic and Motor Vehicle Safety Act of 1966.

- ▶ (1): Locate the statement "The combined weight of occupants and cargo should never exceed XXX kg or XXX lbs." on your vehicle's placard.
- ▶ (2): Determine the combined weight of the driver and passengers that will be riding in your vehicle.
- ▶ (3): Subtract the combined weight of the driver and passengers from XXX kg or XXX lbs.
- ▶ (4): The resulting figure equals the available amount of cargo and luggage load capacity. For example, if the "XXX" amount equals 1400 lbs. and there will be five 150 lb passengers in your vehicle, the amount of available cargo and luggage load capacity is 650 lbs. (1400 - 750 (5 x 150) = 650 lbs.)
- ▶ (5): Determine the combined weight of luggage and cargo being loaded on the vehicle. That weight may not safely exceed the available cargo and luggage load capacity calculated in Step 4.

- ▶ (6): If your vehicle will be towing a trailer, load from your trailer will be transferred to your vehicle. Consult this manual to determine how this reduces the available cargo and luggage load capacity of your vehicle.

- ▶ **i** Not all vehicles are permitted to tow a trailer. Towing a trailer is only permitted if a trailer-hitch is installed. Please consult an authorized Mercedes-Benz dealer if you have any questions about towing a trailer with your vehicle.

Even if you have calculated the total load carefully, you should still make sure that the maximum permissible gross weight and the maximum gross axle weight rating of your vehicle are not exceeded. Details can be found on the vehicle identification plate.

- ▶ Have your loaded vehicle – including driver, occupants and load – weighed on a vehicle weighbridge. The measured values may not exceed the maximum permissible values stated on the vehicle identification plate.

## 324 Wheels and tires

Further related subjects:

- Calculation example for determining the maximum load (→ page 324)
- Tire and loading information placard (→ page 322)
- Tire pressure table (→ page 317)
- Vehicle identification plate (→ page 348)

### Calculation example for determining the maximum load

The following table shows examples of how to calculate total and cargo load capacities with varying seating configurations and different numbers and weights of vehicle occupants. The following examples assume a maximum load of 1500 lbs

(680 kg). **This is for illustration purposes only.** Make sure you are using the actual load limit for your vehicle stated on your vehicle's tire and loading Information placard (→ page 322).

The greater the weight of all the vehicle occupants, the smaller the maximum luggage load.

### Step 1

	Example 1	Example 2
Combined maximum weight of vehicle occupants and load (data from the tire and loading information placard)	1500 lbs (680 kg)	1500 lbs (680 kg)

**Step 2**

	Example 1	Example 2
Number of persons in the vehicle (driver and passengers)	5	1
Occupant distribution	Front: 2 Rear: 3	Front: 1
Weight of vehicle occupants	Occupant 1: 150 lbs (68 kg) Occupant 2: 180 lbs (82 kg) Occupant 3: 160 lbs (73 kg) Occupant 4: 140 lbs (63 kg) Occupant 5: 120 lbs (54 kg)	Occupant 1: 200 lbs (91 kg)
Total weight of all vehicle occupants	750 lbs (340 kg)	200 lbs (91 kg)

**Step 3**

	Example 1	Example 2
Permissible load (maximum gross vehicle weight from the tire and loading information placard minus the total weight of all occupants)	1500 lbs (680 kg) - 750 lbs (340 kg) = 750 lbs (340 kg)	1500 lbs (680 kg) - 200 lbs (91 kg) = 1300 lbs (589 kg)

## Tire labeling

### Overview of tire labeling

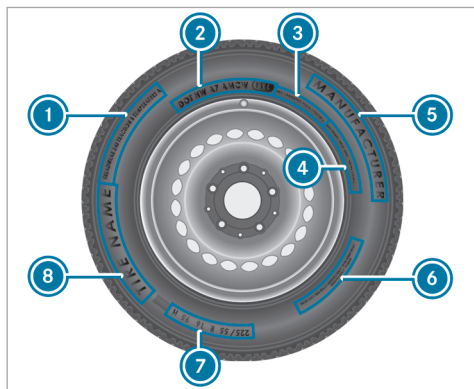

- ① Uniform Tire Quality Grading Standards
- ② DOT (Department of Transportation), (TIN) Tire Identification Number
- ③ Maximum tire load (→ page 328)
- ④ Maximum tire pressure (→ page 329)

- ⑤ Manufacturer
- ⑥ Tire characteristics (→ page 329)
- ⑦ Tire size designation, load-bearing capacity, speed rating and load index (→ page 329)
- ⑧ Tire name
- ⓘ The data shown in the illustration is example data.

### Tire quality grading

In accordance with the US Department of Transportation's "Uniform Tire Quality Grading Standards," tire manufacturers are required to grade their tires on the basis of the following three performance factors:

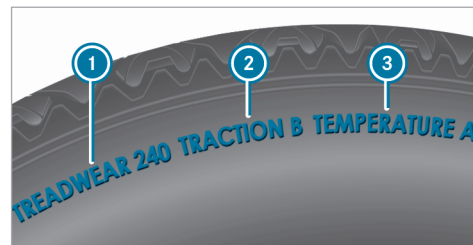

- ① Tread wear grade
- ② Traction grade
- ③ Temperature grade
- ⓘ The data shown in the illustration is example data.
- ⓘ The classification is not legally stipulated for Canada, but it is generally stated.

### Tread wear grade

The treadwear grade is a comparative rating based on the wear rate of the tire when tested under controlled conditions on a specified government test course. For example, a tire graded 150 would wear one and one-half (1 1/2) times as



well on the government course as a tire graded 100.

The relative performance of tires depends upon the actual conditions of their use, however, and may depart significantly from the norm due to variations in driving habits, service practices and differences in road characteristics and climate.

### Traction grade

**⚠ DANGER** Risk of accident due to inadequate traction

The traction grade assigned to this tire is based on straight-ahead braking traction tests.

- ▶ Always adapt your driving style and drive at a speed to suit the prevailing traffic and weather conditions.

**! NOTE** Damage to the drivetrain from wheelspin

- ▶ Avoid wheelspin.

The traction grades, from highest to lowest, are AA, A, B, and C. Those grades represent the tire's ability to stop on wet pavement as measured under controlled conditions on specified government test surfaces of asphalt and concrete. A tire marked C may have poor traction performance.

### Temperature grade

**⚠ WARNING** Risk of accident from tire overheating and tire failure

Excessive speed, underinflation, or excessive loading, either separately or in combination, can cause excessive heat build-up and possible tire failure.

- ▶ Observe the recommended tire pressure.
- ▶ Regularly check the pressure of all the tires.
- ▶ Adjust the tire pressure, if necessary.

The temperature grades are A (the highest), B, and C, representing the tire's resistance to the generation of heat and its ability to dissipate heat when tested under controlled conditions on a specified indoor laboratory test wheel. Sustained

high temperature can cause the material of the tire to degenerate and reduce tire life, and excessive temperature can lead to sudden tire failure. The grade C corresponds to a level of performance which all passenger car tires must meet under the Federal Motor Safety Standard No. 109. Grades B and A represent higher levels of performance on the laboratory test wheel than the minimum required by law.

### DOT, Tire Identification Number (TIN)

US tire regulations stipulate that every tire manufacturer or retreader must imprint a TIN in or on the side wall of each tire produced.

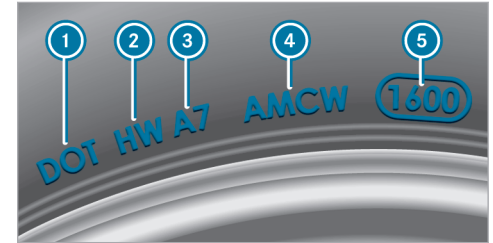

- i** The data shown in the illustration is example data.

The TIN is a unique identification number to identify tires and comprises the following:

- **DOT (Department of Transportation):** tire symbol marks **1** indicating that the tire complies with the requirements of the US Department of Transportation.
- **Manufacturer identification code:** manufacturer identification code **2** contains details of the tire manufacturer. New tires have a code with two symbols. Retreaded tires have a code with four symbols. Further information on retreaded tires (→ page 334).
- **Tire size:** identifier **3** describes the tire size.
- **Tire type code:** tire type code **4** can be used by the manufacturer as a code to describe specific characteristics of the tire.
- **Manufacturing date:** manufacturing date **5** provides information about the age of a tire. The 1st and 2nd positions represent the calendar week and the 3rd and 4th positions

state the year of manufacture (e.g. "3208" represents the 32nd week of 2008).

### Information on the maximum tire load

#### **⚠ WARNING** Risk of accident from overloaded tires

Overloaded tires may overheat and burst as a consequence. Overloaded tires can also impair the steering and handling characteristics and lead to brake failure.

- ▶ Observe the load rating of the tires.
- ▶ The load rating must be at least half the permissible axle load of the vehicle.
- ▶ Never overload the tires by exceeding the maximum load.



- i** The data shown in the illustration is example data.

Maximum tire load **1** is the maximum permissible weight for which the tire is approved.

Do not overload the tires by exceeding the specified load limit. The maximum permissible load can be found on the vehicle's Tire and Loading Information placard on the B-pillar on the driver's side (→ page 322).

### Specifications for maximum tire pressure

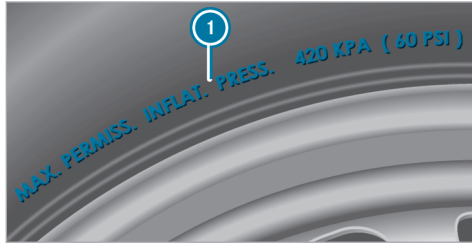

**i** The data shown in the illustration is example data.

Never exceed maximum tire pressure **1** specified for the tire. Always observe the recommended tire pressure for your vehicle when adjusting the tire pressure (→ page 317).

### Information on tire characteristics



**i** The data shown in the illustration is example data.

This information describes the type of tire cord and the number of layers in side wall **1** and under tire tread **2**.

### Tire size designation, load-bearing capacity, speed rating and load index

**⚠ WARNING** Risk of injury through exceeding the specified tire load-bearing capacity or the permissible speed rating

Exceeding the specified tire load rating or the permissible speed rating may lead to tire damage and to the tires bursting.

- ▶ Therefore, only use tire types and sizes approved for your vehicle model.
- ▶ Observe the tire load rating and speed rating required for your vehicle.

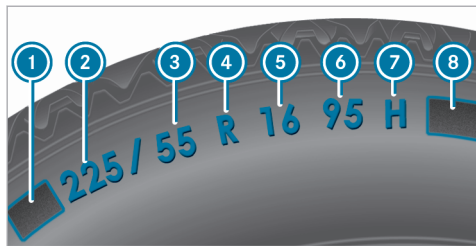

- ① Preceding letter
- ② Nominal tire width in millimeters
- ③ Aspect ratio in %
- ④ Tire code
- ⑤ Rim diameter
- ⑥ Load bearing index
- ⑦ Speed rating
- ⑧ Load index

**i** The data shown in the illustration is example data.

Information about reading tire data can be obtained from any qualified specialist workshop.

#### Preceding letter ①:

- None: passenger car tire according to European manufacturing standards.
- "P": passenger car tire according to US manufacturing standards.
- "LT": light truck tire according to US manufacturing standards.
- "T": compact emergency spare wheel with high tire pressure which is only designed for temporary use in an emergency.

#### Aspect ratio ③:

Ratio between tire height and tire width in percent (tire height divided by tire width).

#### Tire code ④ (tire type):

- "R": radial tire
- "D": bias ply tire
- "B": bias belted tire
- "ZR": radial tire with a maximum speed above 149 mph (240 km/h) (optional)

#### Rim diameter ⑤:

The diameter of the bead seat (not the diameter of the rim flange). The rim diameter is specified in inches (in).

#### Load bearing index ⑥:

Numerical code that specifies the maximum load-bearing capacity of a tire (e.g. "91" corresponds to 1356 lbs (615 kg)).

The load-bearing capacity of the tire must be at least half the gross axle weight rating of the vehicle. Do not overload the tires by exceeding the specified load limit.

See also:

- Maximum permissible load on the tire and loading information placard (→ page 322)
- Maximum tire load (→ page 328)
- Load index

#### Speed rating ⑦:

Specifies the approved maximum speed of the tire.

- i** An electronic speed limiter prevents your vehicle from exceeding a speed of 130 mph (210 km/h).

Make sure that your tires have the required speed rating. You can obtain information on the required speed rating from an authorized Mercedes-Benz service outlet.

#### Summer tires

Index	Speed rating
Q	up to 100 mph (160 km/h)
R	up to 106 mph (170 km/h)
S	up to 112 mph (180 km/h)
T	up to 118 mph (190 km/h)
H	up to 130 mph (210 km/h)
V	up to 149 mph (240 km/h)
W	up to 168 mph (270 km/h)

<sup>1</sup> "ZR" stated in the tire code.

<sup>2</sup> Or "M+S"  for winter tires.

Index	Speed rating
Y	up to 186 mph (300 km/h)
ZR...Y <sup>1</sup>	up to 186 mph (300 km/h)
ZR... (..Y) <sup>1</sup>	over 186 mph (300 km/h)
ZR <sup>1</sup>	over 149 mph (240 km/h)

- Specifying the speed rating as "ZR" in the tire code **4** is optional for tires up to 186 mph (300 km/h).
- If your tire code **4** includes "ZR" and there is no speed rating **7**, find out the maximum speed from the tire manufacturer.
- If the load-bearing index **6** and speed rating **7** are in brackets, the maximum speed rating of your tire is above 186 mph (300 km/h). Ask the tire manufacturer about the maximum speed.

#### All-weather tires and winter tires

Index	Speed rating
Q M+S <sup>2</sup>	up to 100 mph (160 km/h)
T M+S <sup>2</sup>	up to 118 mph (190 km/h)
H M+S <sup>2</sup>	up to 130 mph (210 km/h)
V M+S <sup>2</sup>	up to 149 mph (240 km/h)

Winter tires bear the  snowflake symbol and fulfill the requirements of the Rubber Manufacturers Association (RAM) and the Rubber Association of Canada (ARC) regarding the tire traction on snow.

#### Load index **8**:

- No specification given: standard load (LS) tire
- "XL" or "Extra Load": extra load tire or reinforced tire
- "Light Load": light load tire

- "C", "D", "E": load range depends on the maximum load that the tire can carry at a certain pressure

### Definition of terms for tires and loading

**Tire structure and characteristics:** describes the number of layers or the number of rubber-coated belts in the tire contact surface and the tire wall. These are made of steel, nylon, polyester and other materials.

**Bar:** metric unit for tire pressure. 14.5038 pounds per square inch (psi) and 100 kilopascal (kPa) is the equivalent of one bar.

**DOT (Department of Transportation):** DOT-marked tires fulfill the requirements of the US Department of Transportation.

**Average weight of the vehicle occupants:** the number of vehicle occupants for which the vehicle is designed, multiplied by 150 lb (68 kg).

**Uniform tire quality grading standards:** a uniform standard to grade the quality of tires with regard to tread quality, tire traction and temperature characteristics. The quality grading assessment is

made by the manufacturer following specifications from the U.S. government. The quality grade of a tire is imprinted on the side wall of the tire.

**Recommended tire pressure:** the recommended tire pressure is the tire pressure specified for the tires fitted to the vehicle at the factory.

The tire and load information table contains the recommended tire pressure for cold tires, the maximum permissible load and the maximum permissible vehicle speed.

The tire pressure table contains the recommended tire pressure for cold tires under various operating conditions, i.e. loading and/or speed of the vehicle.

**Increased vehicle weight due to optional equipment:** the combined weight of all standard and optional equipment available for the vehicle, regardless of whether it is actually installed on the vehicle or not.

**Rim:** the part of the wheel on which the tire is mounted.

**GAWR (Gross Axle Weight Rating):** the GAWR is the maximum gross axle weight rating. The actual load on an axle must never exceed the gross axle

weight rating. The gross axle weight rating can be found on the vehicle identification plate on the B-pillar on the driver's side.

**Speed rating:** the speed rating is part of the tire identification. It specifies the speed range for which a tire is approved.

**GVW (Gross Vehicle Weight):** the gross vehicle weight comprises the weight of the vehicle including fuel, tools, spare wheel, fitted accessories, occupants, luggage and the trailer tongue weight, if applicable. The gross vehicle weight must not exceed the gross vehicle weight rating GVWR as specified on the vehicle identification plate on the B-pillar on the driver's side.

**GVWR (Gross Vehicle Weight Rating):** the GVWR is the maximum permitted gross weight of the fully laden vehicle (weight of the vehicle including all accessories, occupants, fuel, luggage and the trailer tongue weight if applicable). The gross vehicle weight rating is specified on the vehicle identification plate on the B-pillar on the driver's side.

**Maximum weight of the laden vehicle:** the maximum weight is the sum of the unladen weight of the vehicle, the weight of the accessories, the

maximum load and the weight of optional equipment installed at the factory.

**Kilopascal (kPa):** metric unit for tire pressure. 6.9 kPa corresponds to 1 psi. Another unit for tire pressure is bar. 100 kilopascal (kPa) equals 1 bar.

**Load index:** in addition to the load-bearing index, the load index may also be imprinted on the side wall of the tire. This specifies the load-bearing capacity of the tire more precisely.

**Unladen weight:** the weight of a vehicle with standard equipment including the maximum capacity of fuel, service fluids and coolant. It also includes the air conditioning system and optional equipment if these are installed in the vehicle, but does not include passengers or luggage.

**Maximum tire load:** the maximum tire load is the maximum permissible weight in kilograms or lbs for which a tire is approved.

**Maximum permissible tire pressure:** maximum permissible tire pressure for one tire.

**Maximum load on one tire:** maximum load per tire. This is calculated by dividing the maximum axle load of one axle by two.

**PSI (pounds per square inch):** standard unit of measurement for tire pressure.

**Aspect ratio:** ratio between tire height and tire width in percent.

**Tire pressure:** pressure inside the tire applying an outward force to every square inch of the tire. The tire pressure is specified in pounds per square inch (psi), in kilopascals (kPa) or in bar. The tire pressure should only be corrected when the tires are cold.

**Cold tire pressure:** the tires are cold when the vehicle has been parked for at least 3 hours without direct sunlight on the tires, or the vehicle has been driven for less than 1 mile (1.6 km).

**Tire contact surface:** the part of the tire that comes into contact with the road.

**Tire bead:** the purpose of the tire bead is to ensure that the tire sits securely on the wheel rim. There are several wire cores in the tire bead to prevent the tire from changing length on the wheel rim.

**Side wall:** the part of the tire between the tread and the tire bead.

**Weight of optional equipment:** the combined weight of the optional equipment weighing more than the replaced standard parts and more than 5 lbs (2.3 kg). This optional equipment, such as high-performance brakes, level control system, a roof luggage rack or high-performance batteries, is not included in the unladen weight and the weight of the accessories.

**TIN (Tire Identification Number):** a unique identification number which can be used by a tire manufacturer to identify tires, for example in a product recall, and thus identify the purchasers. The TIN is made up of the manufacturer's identity code, tire size, tire type code and the manufacturing date.

**Load-bearing index:** the load-bearing index is a code that contains the maximum load-bearing capacity of a tire.

**Traction:** traction is the grip resulting from friction between the tire and the road surface.

**Wear indicator:** narrow bars (tread wear bars) that are distributed over the tire contact surface. If the tire tread is level with the bars, the wear limit of 1/16 in (1.6 mm) has been reached.

**Distribution of vehicle occupants:** distribution of vehicle occupants over designated seat positions in a vehicle.

**Maximum permissible payload weight:** nominal load and luggage load plus 150 lb (68 kg) multiplied by the number of seats in the vehicle.

### Changing a wheel

#### Notes on selecting, installing and replacing tires

**!** **NOTE** Mercedes-AMG vehicles

▶ Observe the notes in the Supplement. You could otherwise fail to recognize dangers.

**!** **WARNING** Risk of accident due to incorrect wheel and tire dimensions

If wheels and tires of the wrong size are installed, the service brakes or components in the brake system and in the wheel suspension may be damaged.

▶ Always replace wheels and tires with ones that fulfill the specifications of the original part.

For wheels, pay attention to the following:

- Designation
- Type

For tires, pay attention to the following:

- Designation
- Manufacturer
- Type

**!** **WARNING** Risk of injury through exceeding the specified tire load-bearing capacity or the permissible speed rating

Exceeding the specified tire load rating or the permissible speed rating may lead to tire damage and to the tires bursting.

- ▶ Therefore, only use tire types and sizes approved for your vehicle model.
- ▶ Observe the tire load rating and speed rating required for your vehicle.

**!** **NOTE** Vehicle and tire damage caused by non-approved tire types and sizes

For safety reasons, only use tires, wheels and accessories which have been specially approved by Mercedes-Benz for your vehicle.

These tires are specially adapted to the active safety systems, such as ABS, ESP® and 4MATIC, and marked as follows:

- MO = Mercedes-Benz Original
- MOE = Mercedes-Benz Original Extended (tires with run-flat characteristics for certain wheels only)
- MO1 = Mercedes-Benz Original (only certain AMG tires)

Otherwise, certain properties, such as driving characteristics, vehicle noise emissions, consumption, etc. could be adversely affected. Furthermore, other tire sizes could result in the tires rubbing against the body and axle components when loaded. This could result in damage to the tire or the vehicle.



Only use tires, wheels and accessories that have been checked and recommended by Mercedes-Benz.

**!** **NOTE** Risk to driving safety from retreaded tires

Retreaded tires are neither tested nor recommended by Mercedes-Benz, since previous damage cannot always be detected on retreaded tires.

For this reason driving safety cannot be guaranteed.

- ▶ Do not use used tires if you have no information about their previous usage.

**!** **NOTE** Possible wheel and tire damage when driving over obstacles

Large wheels have a smaller section width. As the section width decreases, the risk of wheels and tires being damaged when driving over obstacles increases.

- ▶ Avoid obstacles or drive especially carefully.
- ▶ Reduce your speed when driving over curbs, speed bumps, manhole covers and potholes.
- ▶ Avoid particularly high curbs.

**!** **NOTE** Possible wheel and tire damage when parking on curbs or in potholes

Parking on curbs or in potholes can damage the wheels and tires.

- ▶ Only park on as level a surface as possible.
- ▶ Avoid curbs and potholes when parking.

**!** **NOTE** Damage to electronic components due to the use of mounting tools

**Vehicles with a tire pressure monitoring system:** there are electronic components in the wheel.

Using mounting tools in the area of the valve may damage the electronic components.

- ▶ Tire mounting tools should not be used in the area of the valve.
- ▶ Always have tires changed at a qualified specialist workshop.

**!** **NOTE** Damage to summer tires at low ambient temperatures

At low ambient temperatures, tears could form when driving with summer tires, causing permanent damage to the tires.

- ▶ At temperatures below 45 °F (7 °C) use  M+S tires.

Accessory parts which are not approved for your vehicle by Mercedes-Benz, or which are not used correctly, can impair the operating safety.

Before purchasing and using non-approved accessories, visit a qualified specialist workshop and enquirer about:

- Suitability
- Legal stipulations
- Factory recommendations

**⚠ WARNING** Risk of accidents with sports tires

The special tire tread in combination with the optimized tire compound means that the risk of skidding or hydroplaning on wet roads is increased.

In addition, the tire grip is greatly reduced at a low outside temperature and tire running temperature.

- ▶ Switch on ESP® and adapt your driving style accordingly.
- ▶ Use  M+S tires at outside temperatures of less than 45 °F (7 °C).
- ▶ Only use tires suitable for the intended use.

Observe the following when selecting, installing and replacing tires:

- Furthermore, the use of certain tire types in certain regions and areas of operation can be highly beneficial.

- Only use tires and wheels of the same type (summer tires, winter tires, MOExtended tires) and same make.
- Only install wheels of the same size on one axle (left and right).

The only permitted exception is installation of a different wheel size in the event of a flat tire, in order to drive to a specialist workshop.

- **Vehicles with a tire pressure monitoring system:** all installed wheels must be equipped with functioning sensors for the tire pressure monitoring system.
- At temperatures below 45 °F (7 °C), use winter tires or all-season tires marked  M+S for all wheels.

Winter tires provide the best possible grip in wintry road conditions.

- M+S tires: only use tires with the same tread.
- Observe the maximum permissible speed for the installed M+S tires.

If the tire's maximum speed is below that of the vehicle, this must be indicated by an appropriate label in the driver's field of vision.

- Break in new tires at moderate speeds for the first 60 miles (100 km).
- Replace the tires after six years at the latest, regardless of wear.
- **When replacing with tires that do not have run-flat characteristics:** Vehicles with MOExtended tires are not equipped with a TIREFIT kit at the factory. Equip the vehicle with a TIREFIT kit after replacing with tires that do not feature run-flat characteristics, e.g. winter tires.

For more information on wheels and tires, contact a qualified specialist workshop.

Be sure to also observe the following related aspects:

- Notes on tire pressure (→ page 315)
- Tire and loading information placard (→ page 322)
- Tire size designation, load-bearing capacity, speed rating and load index (→ page 329)
- Tire pressure table (→ page 317)

- Notes on the emergency spare wheel (→ page 343)

### Notes on rotating tires

**⚠ WARNING** Risk of injury through different wheel sizes

Rotating the front and rear wheels can severely impair the driving characteristics.

The wheel brakes or suspension components may also be damaged.

- ▶ Rotate front and rear wheels only if the wheels and tires are of the same dimensions.

Observe the instructions and safety notes on "Changing a wheel" (→ page 334).

The wear patterns on the front and rear tires differ:

- front tires wear more on the tire shoulder
- rear tires wear more in the center of the tire

Do not drive with tires that have too little tread depth. This significantly reduces traction on wet roads (hydroplaning).

On vehicles that have the same front and rear wheel size, rotate the tires according to the intervals in the tire manufacturer's warranty book in your vehicle documents. If this is not available, rotate the tires every 3,000 to 6,000 miles (5,000 to 10,000 km), depending on the wear. Ensure that the direction of rotation is maintained.

### Notes on storing wheels

When storing wheels, observe the following notes:

- After removing wheels, store them in a cool, dry and preferably dark place.
- Protect the tires from contact with oil, grease or fuel.

### Overview of the tire-change tool kit

**!** **NOTE** Mercedes-AMG vehicles

- ▶ Observe the notes in the Supplement. You could otherwise fail to recognize dangers.

Apart from some country-specific variants, vehicles are not equipped with a tire-change tool kit. Consult a qualified specialist workshop to find out which wheel change tools are necessary and approved for changing a wheel on your vehicle.

You require the following tools, for example, to change a wheel:

- Jack
- Chock
- Lug wrench
- Alignment bolt

The tire-change tool kit is located in tool bag **1** in the trunk.

- ① Depending on the vehicle equipment, the tool bag may be located at other positions in the trunk.
- ① When stowing the tool bag, make sure that it is adequately secured.

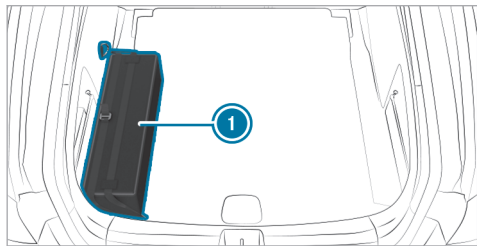

The tool bag contains:

- Jack
- Gloves
- Lug wrench
- Alignment bolt
- Folding chock
- Ratchet for jack

### Preparing the vehicle for a wheel change

#### Requirements

- The vehicle is not on a slope.
- The vehicle is on solid, non-slippery and level ground.
- The required wheel changing tools are on board.

- ① If your vehicle is not equipped with wheel changing tools, consult a qualified specialist workshop to find out about suitable tools.

- ▶ Apply the electric parking brake manually.
- ▶ Move the front wheels to the straight-ahead position.
- ▶ Shift the transmission to position **P**.
- ▶ Switch off the vehicle.
- ▶ Make sure that the vehicle cannot be started.
- ▶ Place chocks or other suitable items under the wheel that is diagonally opposite the wheel you wish to change.
- ▶ If necessary, remove the hub cap/hub cover (→ page 338).

- ▶ Raise the vehicle (→ page 339).

### Removing and installing the wheel trim/hub caps

#### Requirements

- The vehicle is prepared for a wheel change (→ page 338).

#### Plastic hub cap

##### To remove:

- ▶ Turn the center cover of the hub cap counter-clockwise and remove the hub cap.

##### To install:

- ▶ Make sure that the center cover of the hub cap is turned counter-clockwise.
- ▶ Position the hub cap and turn the center cover clockwise until the hub cap engages physically and audibly.

### Aluminum hub cap

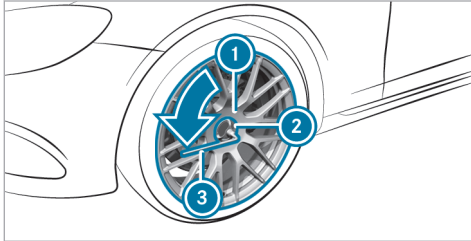

#### To remove:

- ▶ Position socket ② from the tire-change tool kit on hub cap ①.
- ▶ Position wheel wrench ③ on socket ②.
- ▶ Using wheel wrench ③, turn hub cap ① counter-clockwise and remove it.

#### To install:

- ▶ Follow the instructions above in reverse order.

**i** Specified tightening torque: 18 lb-ft (25 Nm).

### Raising the vehicle when changing a wheel

#### Requirements

- There are no persons in the vehicle.
- The vehicle has been prepared for a wheel change (→ page 338).

#### Important notes on using the jack:

- Use only a vehicle-specific jack that has been approved by Mercedes-Benz to raise the vehicle.
- The jack is only designed for raising and holding the vehicle for a short time while a wheel is being changed and not for maintenance work under the vehicle.
- The jack must be placed on a firm, flat and non-slip surface. If necessary, use a large, flat, load-bearing, non-slip underlay.
- The foot of the jack must be positioned vertically under the jack support point.

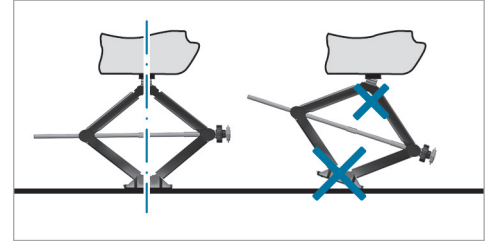

#### Rules of conduct when the vehicle is raised:

- Never place your hands or feet under the vehicle.
- Never lie under the vehicle.
- Do not start the vehicle and do not release the electric parking brake.
- Do not open or close any doors or the trunk lid.

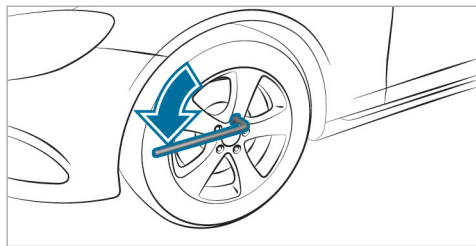

- ▶ Using the lug wrench, loosen the wheel bolts on the wheel you wish to change by about one full turn. Do not unscrew the screws completely.

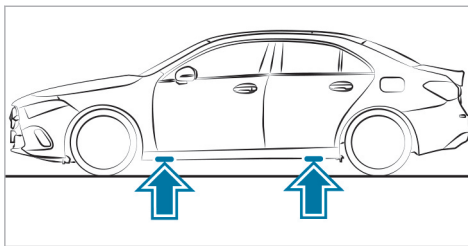

Position of the jack support points

**!** **NOTE** Mercedes-AMG vehicles

- ▶ Observe the notes in the Supplement. You could otherwise fail to recognize dangers.

**⚠** **WARNING** Risk of injury from incorrect positioning of the jack

If you do not position the jack correctly at the appropriate jacking point of the vehicle, the jack could tip with the vehicle raised.

- ▶ Only position the jack at the appropriate jacking point of the vehicle. The base of

the jack must be positioned vertically under the jacking point of the vehicle.

**!** **NOTE** Damage to the vehicle due to the jack

If you do not position the jack at the jack support points provided for this purpose, you could damage your vehicle.

- ▶ Only position the jack at the jack support points provided for this purpose.

- ▶ Take the ratchet out of the tire-change tool kit and place it on the hexagon nut of the jack so that the letters "AUF" are visible.

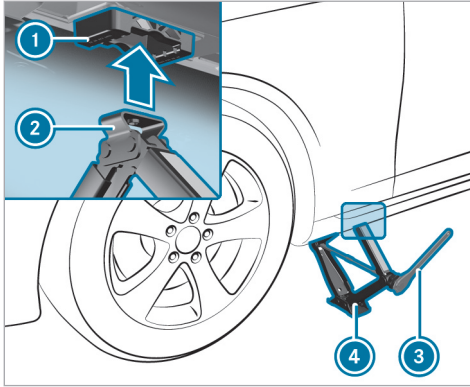

- ▶ Position support ② of jack ④ on jack support point ①.

**i** If there is a total loss of pressure in a tire, it may be possible that the jack cannot be positioned at jack support point ①. In this case, unload the vehicle.

- ▶ Turn ratchet ③ clockwise until support ② sits completely on jack support point ① and the base of the jack lies evenly on the ground.
- ▶ Turn ratchet ③ until the tire is raised a maximum of 1.2 in (3 cm) from the ground.
- ▶ Loosen and remove the wheel (→ page 341).

### Removing a wheel

#### Requirements

- The vehicle is raised (→ page 339).

**!** **NOTE** Mercedes-AMG vehicles

- ▶ Observe the notes in the Supplement. You could otherwise fail to recognize dangers.

When changing a wheel, avoid applying any force to the brake discs, since this could impair the level of comfort when braking.

**!** **NOTE** Damage to threading from dirt on wheel bolts

- ▶ Do not place wheel bolts in sand or on a dirty surface.

- ▶ Unscrew the uppermost wheel bolt completely.

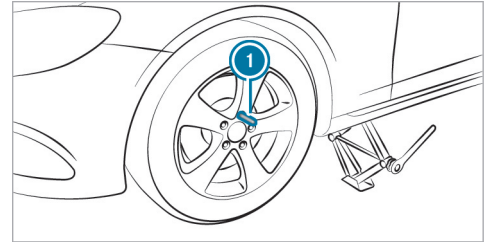

- ▶ Screw centering pin ① into the thread instead of the wheel bolt.
- ▶ Unscrew the remaining wheel bolts completely.
- ▶ Remove the wheel.

## Mounting a new wheel

### Requirements

- The wheel to be changed is removed and the centering pin is screwed in (→ page 341).

#### **!** NOTE Mercedes-AMG vehicles

- ▶ Observe the notes in the Supplement. You could otherwise fail to recognize dangers.

#### **!** WARNING Risk of accident from losing a wheel

Oiled, greased or damaged wheel bolt/wheel nut threads or wheel hub/wheel mounting bolt threads can cause the wheel bolts/wheel nuts to come loose.

- ▶ Never oil or grease the threads.
- ▶ In the event of damage to the threads, contact a qualified specialist workshop immediately.
- ▶ Have the damaged wheel bolts or damaged hub threads replaced.

- ▶ Do not continue driving.

- ▶ Observe the information on the choice of tires (→ page 334).

For tires with a specified direction of rotation, an arrow on the side wall of the tire indicates the correct direction of rotation. Observe the direction of rotation when mounting.

- ▶ Slide the wheel to be mounted onto the centering pin and push it on.

#### **!** WARNING Risk of injury from tightening wheel bolts and nuts

If you tighten the wheel bolts or wheel nuts when the vehicle is raised, the jack could tip.

- ▶ Only tighten wheel bolts or wheel nuts when the vehicle is on the ground.

- ▶ Be sure to observe the instructions and safety notes on "Changing a wheel" (→ page 334).

- ▶ For safety reasons, only use wheel bolts which have been approved by Mercedes-Benz and for the wheel in question.

#### **!** NOTE Damage to paintwork of the wheel rim when screwing in the first wheel bolt

If the wheel has too much play when screwing in the first wheel bolt, the wheel rim paint can be damaged.

- ▶ Press the wheel firmly against the wheel hub when screwing in the first wheel bolt.

- ▶ Tighten the wheel bolts evenly in a diagonal pattern in the order indicated until they are finger-tight.
- ▶ Unscrew and remove the centering pin.
- ▶ Tighten the last wheel bolt until it is finger-tight.
- ▶ Lower the vehicle (→ page 342).

## Lowering the vehicle after a wheel change

### Requirements

- The new wheel has been installed (→ page 342).



- ▶ **To lower the vehicle:** place the ratchet onto the hexagon nut of the jack so that the letters "AB" are visible and turn counter-clockwise.

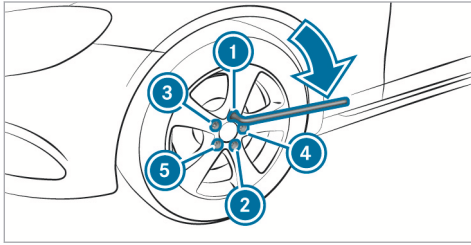

- ▶ Tighten the wheel bolts evenly in a diagonal pattern in the order indicated ① to ⑤ with an initial maximum force of 59 lb-ft (80 Nm).
- ▶ Tighten the wheel bolts evenly in a diagonal pattern in the order indicated ① to ⑤ with the specified tightening torque of 96 lb-ft (130 Nm).

- ⚠ **WARNING** Risk of accident due to incorrect tightening torque

The wheels could come loose if the wheel bolts or wheel nuts are not tightened to the prescribed torque.

- ▶ Ensure that the wheel bolts or wheel nuts are tightened to the prescribed tightening torque.
- ▶ If you are not sure, do not move the vehicle. Contact a qualified specialist workshop and have the tightening torque checked immediately.

- ▶ Check the tire pressure of the newly installed wheel and adjust it if necessary.
- ⓘ The following does not apply if the new wheel is an emergency spare wheel.
- ▶ **Vehicles with a tire pressure loss warning system:** restart the tire pressure loss warning system (→ page 321).
- ▶ **Vehicles with a tire pressure monitoring system:** restart the tire pressure monitoring system (→ page 320).

## Emergency spare wheel

### Notes on the emergency spare wheel

- ⚠ **WARNING** Risk of accident caused by incorrect wheel and tire dimensions

The wheel or tire sizes and the tire type of the emergency spare wheel or spare wheel and the wheel to be replaced may differ. The emergency spare wheel or spare wheel can significantly impair driving characteristics of the vehicle.

To prevent hazardous situations:

- ▶ Drive carefully.
- ▶ Never install more than one emergency spare wheel or spare wheel that differs in size.
- ▶ Only use an emergency spare wheel or spare wheel briefly.
- ▶ Do not deactivate ESP®.
- ▶ Have the emergency spare wheel or spare wheel of a different size replaced at the nearest qualified specialist work-

shop. The new wheel must have the correct dimensions.

- ① The emergency spare wheel is secured in the emergency spare wheel bag in the trunk.

Observe the following notes on installing an emergency spare wheel:

- The maximum permissible speed with an emergency spare wheel installed is 50 mph (80 km/h).
  - Do not install the emergency spare wheel with snow chains.
  - Replace the emergency spare wheel after six years at the latest, regardless of wear.
  - Use the wheel bolts that are included with the emergency spare wheel.
  - Check the tire pressure of the emergency spare wheel when it is installed. Correct the pressure as necessary.
- ① The specified tire pressure is stated on the label of the emergency spare wheel.

- ① **Vehicles with a tire pressure loss warning system:** if an emergency spare wheel is installed, the tire pressure loss warning system cannot function reliably. Only restart the system again when the emergency spare wheel has been replaced with a new wheel.

**Vehicles with a tire pressure monitoring system:** if an emergency spare wheel is installed, the tire pressure monitoring system cannot function reliably. For a few minutes after an emergency spare wheel is installed, the system may still display the tire pressure of the removed wheel. Only restart the system again when the emergency spare wheel has been replaced with a new wheel.

Be sure to also observe the following further related subjects:

- Notes on tire pressure (→ page 315)
- Tire and Loading Information placard (→ page 322)
- Tire pressure table (→ page 317)
- Notes on installing tires (→ page 334)
- Installing an emergency spare wheel (→ page 338)

### Inflating the emergency spare wheel

**!** **NOTE** Overheating due to the tire inflation compressor running too long

▶ Do not run the tire inflation compressor for longer than ten minutes without interruption.

#### Requirements:

Comply with the manufacturer's safety notes on the sticker of the emergency spare wheel and on the tire inflation compressor.

- ▶ Remove the sticker with the label 50 mph (80 km/h) from the tire inflation compressor housing and affix it to the instrument cluster within the driver's field of vision.
- ▶ Remove the tire inflation compressor from the storage well under the trunk floor (→ page 295).

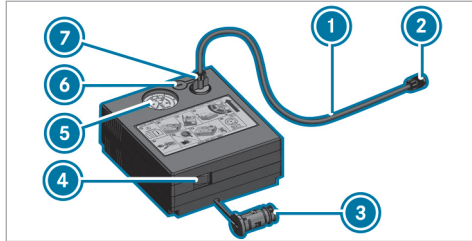

- ▶ Pull filler hose ① and plug ③ out of the tire inflation compressor housing.
- ▶ Insert plug ⑦ of filler hose ① in the socket on the tire inflation compressor and then turn it until plug ⑦ engages.
- ▶ Unscrew the cap from the valve on the emergency spare wheel.
- ▶ Screw union nut ② of filler hose ① onto valve.
- ▶ Make sure on and off switch ④ of the tire inflation compressor is set to 0.
- ▶ Insert plug ③ in a socket in your vehicle.
  - 12 V socket (→ page 115)

- Observe the notes on sockets (→ page 115).
- ▶ Press the start/stop button once to switch on the power supply (→ page 136).
- ▶ Press on and off switch ④ on the tire inflation compressor to 1.  
The tire inflation compressor is switched on. The tire is inflated. The tire pressure is shown on manometer ⑤.
- ▶ Pump the tire to the specified tire pressure.
  - ① The specified tire pressure is stated on the label of the emergency spare wheel.
- ▶ When the specified tire pressure has been reached, press on and off switch ④ on the tire inflation compressor to 0.  
The tire inflation compressor is switched off.
- ▶ Press the start/stop button to switch off the power supply.
- ▶ If the tire pressure is higher than the specified pressure, press pressure release valve button ⑥ until the correct tire pressure has been reached.

- ▶ Unscrew union nut ② of filler hose ① from the valve.
- ▶ Screw the valve cap of the emergency spare wheel onto the valve again.
- ▶ Store filler hose ① and plug ③ in the lower section of the tire inflation compressor housing.
- ▶ Store the tire inflation compressor in the vehicle.

### Notes on technical data

#### **!** NOTE Mercedes-AMG vehicles

- ▶ Observe the notes in the Supplement. You could otherwise fail to recognize dangers.

The data stated only applies to vehicles with standard equipment. You can obtain further information from an authorized Mercedes-Benz Center.

### Vehicle electronics

#### Two-way radios

#### Notes on installing two-way radios

#### **!** WARNING Risk of accident due to improper work on two-way radios

If two-way radios are manipulated or retrofitted incorrectly, the electromagnetic radiation from the two-way radios can interfere with the

vehicle electronics and jeopardize the operating safety of the vehicle.

- ▶ You should have all work on electrical and electronic components carried out at a qualified specialist workshop.

#### **!** WARNING Risk of accident due to improper operation of two-way radios

If you use two-way radios in the vehicle improperly, their electromagnetic radiation can disrupt the vehicle's electronics. This is the case in the following situations, in particular:

- The two-way radio is not connected to an exterior antenna.
- The exterior antenna is installed incorrectly or is not a low-reflection antenna.

This could jeopardize the operating safety of the vehicle.

- ▶ Have the low-reflection exterior antenna installed at a qualified specialist workshop.

- ▶ When operating two-way radios in the vehicle, always connect them to the low-reflection exterior antenna.

#### **!** NOTE Invalidation of the operating permit due to failure to comply with the instructions for installation and use

The operating permit may be invalidated if the instructions for installation and use of two-way radios are not observed.

- ▶ Only use approved frequency bands.
- ▶ Observe the maximum permissible output power in these frequency bands.
- ▶ Only use approved antenna positions.

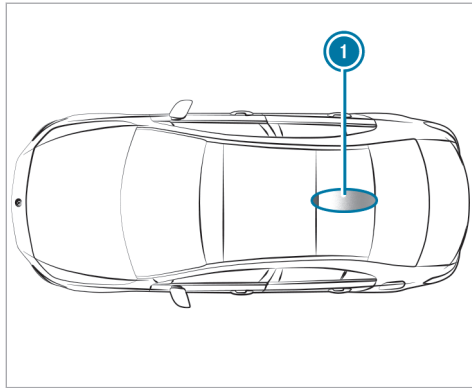

#### ① Rear roof area

On vehicles with a panorama roof with power tilt/sliding panel, installing an antenna is not permitted.

Use Technical Specification ISO/TS 21609 (Road Vehicles - "EMCs for installation of aftermarket radio frequency transmitting equipment") when retrofitting two-way radios. Comply with the legal requirements for detachable parts.

If your vehicle has a pre-installation for two-way radio equipment, use the power supply and antenna connectors provided in the pre-installation. Observe the manufacturer's supplements during installation.

#### ■ Two-way radio transmission output

The maximum transmission output (PEAK) at the base of the antenna must not exceed the values in the following table.

#### Frequency band and maximum transmission output

Frequency band	Maximum transmission output
2 m frequency band 144–174 MHz	50 W
Terrestrial Trunked Radio (TETRA) 380–460 MHz	10 W

Frequency band	Maximum transmission output
Two-way radio 2G	2 W
Two-way radio 3G/4G/5G	0.5 W

The following can be used in the vehicle without restrictions:

- two-way radios with a maximum transmission output of 100 mW
- two-way radios with transmitter frequencies in the 380–410 MHz frequency band and a maximum transmission output of 2 W (TETRA)
- mobile phones (2G/3G/4G/5G)

There are no restrictions regarding the position of the antenna on the outside of the vehicle for the following frequency bands:

- Terrestrial Trunked Radio (TETRA)
- 2G/3G/4G/5G

## Radio regulations

### Regulatory radio identification and specific notes

Manufacturer information about radio-based vehicle components can be found using the key phrase "Regulatory information" in the Digital Operator's Manual in the vehicle, on the Internet and in the app.

Further information and updates are available at the following web address:

[https://  
regulatoryradioinformation.corpinter.net/us](https://regulatoryradioinformation.corpinter.net/us)



### Information about the specific absorption rate (SAR)

Information on the specific absorption rate (SAR) can be found under the key word "Regulatory

information" in the vehicle's Digital Operator's Manual, on the Internet and in the app.

Further information and updates are available at the following web address:

[https://  
regulatoryradioinformation.corpinter.net/us](https://regulatoryradioinformation.corpinter.net/us)



## Vehicle identification plate, VIN and engine number overview

### Vehicle identification plate

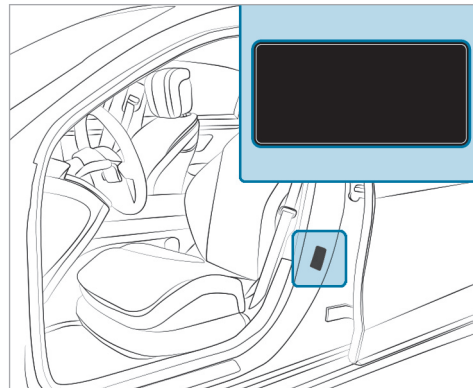

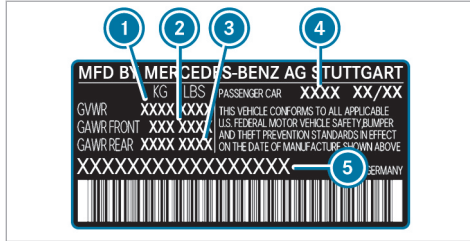

Vehicle identification plate (USA only)

- ① Gross vehicle weight rating
- ② Gross axle weight rating for front axle
- ③ Gross axle weight rating for rear axle
- ④ Paint code
- ⑤ VIN (vehicle identification number)

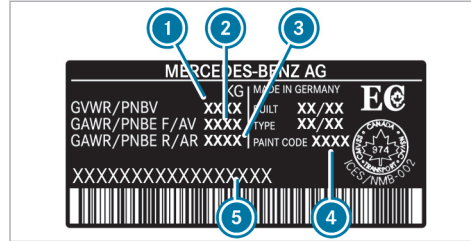

Vehicle identification plate (Canada only)

- ① Gross vehicle weight rating
- ② Gross axle weight rating for front axle
- ③ Gross axle weight rating for rear axle
- ④ Paint code
- ⑤ VIN (vehicle identification number)

The gross vehicle weight rating is made up of the vehicle weight, all vehicle occupants, the fuel and the load. The gross axle weight rating is the maximum weight that can be carried on one axle (front or rear axle).

Do not exceed the gross vehicle weight rating or the gross axle weight rating for the front or rear axle.

### VIN, engine number and other signs

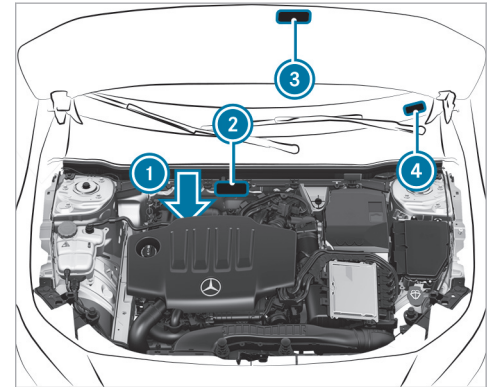

- ① Engine number stamped into the crankcase
- ② VIN (vehicle identification number) stamped onto the crossmember

- ③ Plate with information about emissions testing, including confirmation of emissions guidelines at the U.S. federal level as well as for California
- ④ VIN as a label at the lower edge of the windshield

## Operating fluids

### Notes on operating fluids

#### ! NOTE Mercedes-AMG vehicles

- ▶ Observe the notes in the Supplement. You could otherwise fail to recognize dangers.

#### ⚠ WARNING Risk of injury due to harmful operating fluids

Operating fluids can be toxic.

- ▶ When using, storing and disposing of operating fluids, observe the imprints on the respective original containers.

- ▶ Always keep operating fluids in the sealed original container.
- ▶ Always keep children away from operating fluids.



**ENVIRONMENTAL NOTE** Pollution of the environment due to irresponsible disposal of operating fluids

Incorrect disposal of operating fluids can cause considerable damage to the environment.

- ▶ Dispose of operating fluids in an environmentally responsible manner.

Operating fluids include the following:

- Fuels
- Lubricants
- Coolant
- Brake fluid
- Windshield washer fluid
- Climate control system refrigerant

Only use products approved by Mercedes-Benz. Damage caused by the use of products that have not been approved is not covered by the Mercedes-Benz warranty or goodwill gestures.

The operating fluids approved by Mercedes-Benz can be identified by the following inscriptions on the container:

- MB-Freigabe (e.g. MB-Freigabe 229.51)
- MB-Approval (e.g. MB-Approval 229.51)

Further information on approved operating fluids:

- in the Mercedes-Benz Specifications for Operating Fluids by entering the designation
  - At <https://operatingfluids.mercedes-benz.com>
- At a qualified specialist workshop

#### ⚠ WARNING Risk of fire or explosion from fuel

Fuels are highly flammable.

- ▶ Fire, open flames, smoking and creating sparks must be avoided.



- ▶ Before and during refueling, switch off the vehicle and, if installed, the stationary heater.

### **⚠ WARNING** Risk of injury from fuels

Fuels are poisonous and hazardous to your health.

- ▶ Do not swallow fuel or let it come into contact with skin, eyes or clothing.
- ▶ Do not inhale fuel vapor.
- ▶ Keep children away from fuel.
- ▶ Keep doors and windows closed during the refueling process.

If you or other people come into contact with fuel, observe the following:

- ▶ Immediately rinse fuel off your skin with soap and water.
- ▶ If fuel comes into contact with your eyes, immediately rinse them thoroughly with clean water. Seek medical attention immediately.

- ▶ If you swallow fuel, seek medical attention immediately. Do not induce vomiting.
- ▶ Change immediately out of clothing that has come into contact with fuel.

Flexible-fuel vehicles can be refueled with the following fuel types:

- premium-grade unleaded gasoline
- E85 fuel
- a mixture of E85 fuel and premium-grade unleaded gasoline

Flexible-fuel vehicles can be identified by the **Ethanol up to E85** sticker on the inside of the fuel filler flap.

Depending on the country, the fuels you can use in your vehicle may differ from the information in the Operator's Manual. The fuels that have been approved for your vehicle can be found on the instruction label on the inside of the fuel filler flap.

## Fuel

### **■ Information on fuel quality for vehicles with gasoline engine**

Observe the notes on operating fluids (→ page 350).

#### **! NOTE** Damage caused by incorrect fuel

Even small amounts of the wrong fuel could result in damage to the fuel system, the engine and the emission control system.

- ▶ Only refuel with low-sulfur gasoline.

This fuel may contain up to 10 % ethanol by volume. Your vehicle is suitable for use with E10-fuel.

Never refuel with one of the following fuels:

- diesel
- gasoline with more than 10 % ethanol by volume-, e. g. E15, E85, E100
- gasoline with more than 3 % methanol by volume, e.g. M15, M30, M85, M100

- gasoline with metallic additives

If you have accidentally refueled with the wrong fuel:

- ▶ Do not switch on the vehicle.
- ▶ Consult a qualified specialist workshop.

If the available fuel is not sufficiently low in sulfur, it may produce unpleasant odors.

Refuel only with fuel that has at least the octane number specified on the information label on the fuel filler flap. Otherwise, engine output may be reduced and fuel consumption increased.

**For maximum engine output:** refuel only with premium-grade unleaded gasoline with an octane number of at least 91 AKI/95 RON.

If the recommended fuel is not available, you may also temporarily use regular unleaded gasoline with an octane number of at least 87 AKI/91 RON. This may reduce engine output and increase fuel consumption.

Never refuel using gasoline with an even lower RON.

**!** **NOTE** Premature engine wear through unleaded regular gasoline

Impairment of the longevity and performance of the engine.

If unleaded premium grade gasoline is unavailable and you have to refuel using unleaded regular gasoline:

- ▶ Only fill the fuel tank to half full with unleaded regular gasoline and refill as soon as possible with unleaded premium grade gasoline.
- ▶ Do not drive at the maximum design speed.
- ▶ Avoid sudden acceleration and engine speeds over 3000 rpm.

Further information on fuel is available in the following locations:

- at a gas station
- at a qualified specialist workshop
- **USA only:** On the <https://www.mbusa.com>

### Information on additives in gasoline (vehicles with gasoline engine)

Observe the notes on operating fluids (→ page 350).

**!** **NOTE** Damage from use of unsuitable additives

Even small amounts of the wrong additive may lead to malfunctions occurring.

- ▶ Only add cleaning additives recommended by Mercedes-Benz to the fuel.

Mercedes-Benz recommends that you use brand-name fuels with additives.

In some countries, the fuel available may not have sufficient additives. Deposits could build up in the fuel injection system as a result. In this case, in consultation with a qualified specialist workshop (e.g. an authorized Mercedes-Benz Service Center), mix the fuel with the cleaning additive recommended by Mercedes-Benz. Observe the notes and mixing ratios indicated on the tank.

### Tank content and fuel reserve

#### Total fuel tank capacity

Model	
All models	13.5 gal (51.0 liters)

#### Fuel tank reserve

Model	
All models	1.3 gal (5.0 liters)

### Engine oil

#### Notes on engine oil

Observe the notes on operating fluids (→ page 350).



**!** **NOTE** Engine damage caused by an incorrect oil filter, incorrect oil or additives

- ▶ Do not use engine oils or oil filters other than those which meet the specifications necessary for the prescribed service intervals.
- ▶ Do not alter the engine oil or oil filter in order to achieve longer change intervals than prescribed.
- ▶ Do not use additives.
- ▶ Have the engine oil changed after the prescribed intervals.

Mercedes-Benz recommends having the oil changed at a qualified specialist workshop.

Only use engine oils approved for your vehicle by Mercedes-Benz.

### Engine oil quality and filling capacity

#### Engine oil specification

Model	MB-Freigabe or MB-Approval
All models	229.71, 229.72 <sup>1)</sup>

1) Recommended for the lowest possible fuel consumption (lowest SAE viscosity class in each case; observe possible restrictions of the approved SAE viscosity classes).

To achieve the lowest possible fuel consumption, it is recommended to use the engine oil specifications marked in the table with the lowest SAE viscosity class. Observe any possible restrictions of the approved SAE viscosity classes.

### Engine oil filling capacity

Model	Capacity
All models	5.3 US qt (5.0 liters)

The specified filling capacity refers to an oil change with the oil filter.

### Notes on brake fluid

Observe the notes on operating fluids (→ page 350).

**⚠ WARNING** Risk of an accident due to vapor pockets forming in the brake system

The brake fluid constantly absorbs moisture from the air. This lowers the boiling point of the brake fluid. If the boiling point is too low, vapor pockets may form in the brake system when the brakes are applied hard.

This causes the braking effect to be impaired.

- ▶ Have the brake fluid renewed at the specified intervals.

Have the brake fluid regularly replaced at a qualified specialist workshop.

Only use a brake fluid approved by Mercedes-Benz according to MB-Freigabe or MB-Approval 331.0.

### Coolant

#### Notes on coolant

Observe the notes on operating fluids (→ page 350).

**⚠ WARNING** - Risk of fire and injury from antifreeze

If antifreeze comes into contact with hot component parts in the engine compartment, it may ignite.

- ▶ Allow the engine to cool down before adding antifreeze.
- ▶ Make sure that no antifreeze spills out next to the filler opening.
- ▶ Thoroughly clean off any antifreeze from component parts before starting the vehicle.

**! NOTE** Damage caused by incorrect coolant

- ▶ Only use coolant that has been premixed with the required antifreeze protection.

Information on coolant is available at the following locations:

- In the Mercedes-Benz Specification for Operating Fluids 320.1
  - At <https://operatingfluids.mercedes-benz.com>
- At a qualified specialist workshop

**! NOTE** Overheating at high outside temperatures

If an inappropriate coolant is used, the cooling system is not sufficiently protected against overheating and corrosion at high outside temperatures.

- ▶ Only use coolant approved for Mercedes-Benz.

- ▶ Observe the instructions in the Mercedes-Benz Specifications for Operating Fluids 320.1.

Have the coolant regularly replaced at a qualified specialist workshop.

Proportion of antifreeze concentrate in the cooling system:

- A minimum of 50% (antifreeze protection down to about -35°F (-37°C))
- A maximum of 55% (antifreeze protection down to -49°F (-45°C))

### ■ Coolant filling capacity

#### Coolant (engine)

Model	Capacity
All models	13.6 US qt (12.9 liters)

### Notes on windshield washer fluid

Observe the notes on operating fluids (→ page 350).

**⚠ WARNING** - Risk of fire and injury from windshield washer concentrate

Windshield washer concentrate is highly flammable. It could ignite if it comes into contact with hot engine component parts or the exhaust system.

- ▶ Make sure that no windshield washer concentrate spills out next to the filler opening.

**! NOTE** Damage to the exterior lighting due to unsuitable windshield washer fluid

Unsuitable windshield washer fluid may damage the plastic surface of the exterior lighting.

- ▶ Only use windshield washer fluid which is also suitable for use on plastic surfaces, e.g. MB SummerFit or MB WinterFit.

**! NOTE** Blocked spray nozzles caused by mixing windshield washer fluids

- ▶ Do not mix MB SummerFit and MB WinterFit with other windshield washer fluids.

Do not use distilled or de-ionised water. Otherwise, the fill level sensor may be triggered erroneously.

Recommended windshield washer fluid:

- Above freezing point: e.g. MB SummerFit
- Below freezing point: e.g. MB WinterFit

For the correct mixing ratio, refer to the information on the antifreeze container.

Mix washing water with windshield washer fluid all year round.

### Refrigerant

#### ■ Notes on refrigerant

Observe the notes on operating fluids (→ page 350).

**!** NOTE Damage due to incorrect refrigerant

If a non-approved refrigerant is used, the climate control system may be damaged.

- ▶ Use only R-1234yf refrigerant.

**!** NOTE Damage to the climate control system due to incorrect refrigerant compressor oil

- ▶ Only use refrigerant compressor oil that has been approved by Mercedes-Benz.
- ▶ Do not mix the approved refrigerant compressor oil with a different refrigerant compressor oil.

Work on the climate control system may be carried out only at a qualified specialist workshop. All applicable regulations as well as SAE standard J639 must be adhered to.

The information label for the climate control system regarding the refrigerant type and the refrigerant compressor oil (PAG oil) is located on the inside of the hood.

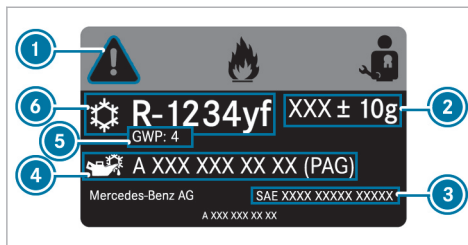

Information label

- ① Hazard and service warning symbols
- ② Refrigerant filling capacity
- ③ Applicable standards
- ④ PAG oil part number
- ⑤ GWP (global warming potential) of the refrigerant used
- ⑥ Refrigerant type

Symbols ① indicate the following:

- Possible dangers
- Have maintenance work carried out at a qualified specialist workshop

## Filling quantity for refrigerant and PAG oil

### Refrigerant filling quantity

Model	
All models	18.7 ± 0.4 oz (530 ± 10 g)

### Filling quantity for PAG oil

Model	
All models	2.8 ± 0.4 oz (80 ± 10 g)

## Vehicle data

### Vehicle dimensions

The heights specified may vary as a result of the following factors:

- Tires
- Load
- Condition of the suspension
- Optional equipment

## Vehicle dimensions

All models	
Vehicle length	184.6 in (4688 mm)
Vehicle width including exterior mirrors	78.7 in (1999 mm)
Vehicle height	57.0 in (1447 mm)
Wheelbase	107.4 in (2729 mm)
Turning radius	36.4 ft (11.1 m)

## Weights and loads

Bear in mind that items of optional equipment increase the curb weight and reduce the payload. Vehicle-specific weight information can be found on the vehicle identification plate.

## Display messages

### Introduction



#### Information about display messages



Display messages appear on the driver's display.

Display messages with graphical symbols are simplified in the Operator's Manual and may differ from the symbols on the driver's display. The driver's display shows high-priority display messages in red. Certain display messages are accompanied by a warning tone.

Please act in accordance with the display messages and follow the additional notes in the Operator's Manual.

For some display messages, symbols will also be shown:

-  Further information
-  Hide display message

With the left-hand Touch Control, you can select the respective symbol by swiping to the left or right. Pressing  displays further information on the central display. Press the  symbol to hide the display message.

Display messages to be acknowledged can be hidden by pressing the back button  or with the left-hand Touch Control. The display messages will then be stored in the message memory.

Rectify the cause of a display message as quickly as possible.

High-priority display messages cannot be hidden. The driver's display will show these display messages continuously until the cause of the display message has been rectified.

#### Calling up saved display messages

Driver's display:





The **Message Memory: XX**message appears on the driver's display.

- ▶ Scroll through the display messages by swiping upwards or downwards on the left-hand Touch Control.
- ▶ **To exit the display:** press the  back button.



## Occupant safety



Display messages	Possible causes/consequences and ► Solutions
 <p data-bbox="194 383 471 429">Restraint System Malfunction Service Required</p>	<p data-bbox="526 295 1053 315">* The restraint system is malfunctioning (→ page 39).</p> <div data-bbox="545 336 1690 450" style="border: 1px solid gray; padding: 5px;"> <p data-bbox="554 341 1265 367"><b>▲ WARNING</b> Risk of injury due to malfunctions in the restraint system</p> <p data-bbox="554 378 1635 409">Components in the restraint system may be activated unintentionally or not deploy as planned in an accident.</p> <p data-bbox="554 414 1524 445">► Have the restraint system checked and repaired immediately at a qualified specialist workshop.</p> </div>
 <p data-bbox="194 559 471 616">Front Left Malfunction Service Required (Example)</p>	<p data-bbox="526 471 1053 492">* The restraint system is malfunctioning (→ page 39).</p> <div data-bbox="545 512 1690 626" style="border: 1px solid gray; padding: 5px;"> <p data-bbox="554 518 1265 543"><b>▲ WARNING</b> Risk of injury due to malfunctions in the restraint system</p> <p data-bbox="554 554 1635 585">Components in the restraint system may be activated unintentionally or not deploy as planned in an accident.</p> <p data-bbox="554 590 1524 621">► Have the restraint system checked and repaired immediately at a qualified specialist workshop.</p> </div>
 <p data-bbox="194 735 471 813">Left Window Airbag Malfunction Service Required (Example)</p>	<p data-bbox="526 647 1053 668">* The restraint system is malfunctioning (→ page 39).</p> <div data-bbox="545 688 1690 823" style="border: 1px solid gray; padding: 5px;"> <p data-bbox="554 694 1469 720"><b>▲ WARNING</b> Risk of injury or fatal injury due to a malfunction in the window curtain airbag</p> <p data-bbox="554 730 1635 782">The window curtain airbag might be triggered unintentionally or might not be triggered at all in the event of an accident.</p> <p data-bbox="554 787 1580 818">► Have the window curtain airbag checked and repaired immediately at a qualified specialist workshop.</p> </div>



Display messages	Possible causes/consequences and ► Solutions
<p>Front Passenger Airbag Disabled See Operator's Manual</p>	<p>* The front passenger air bag and the front passenger knee air bag have been disabled even though an adult or a person of adult build is on the front passenger seat. If additional forces are applied to the seat, the weight the system detects may be too low.</p> <div data-bbox="495 344 1646 550" style="border: 1px solid gray; padding: 5px;"><p><b>▲ WARNING</b> Risk of injury or fatal injury due to a disabled front passenger airbag</p><p>If the front passenger airbag is disabled, the front passenger airbag will not be deployed in the event of an accident and cannot perform its intended protective function.</p><p>A person in the front passenger seat could then, for example, come into contact with the vehicle's interior, especially if the person is sitting too close to the cockpit.</p><p>► Make sure, both before and during the journey, that the status of the front passenger airbag is correct.</p></div> <ul style="list-style-type: none"><li>► Stop the vehicle immediately in accordance with the traffic conditions.</li><li>► Make sure that no objects are trapped under the front passenger seat.</li><li>► Check the status of the automatic front passenger air bag shutoff (→ page 41).</li><li>► If necessary, consult a qualified specialist workshop immediately.</li></ul>
<p>Front Passenger Airbag Enabled See Operator's Manual</p>	<p>* The front passenger air bag and the front passenger knee air bag will be enabled while the vehicle is in motion in the following situations:</p> <ul style="list-style-type: none"><li>• even when a child, a small adult or an object weighing less than the system weight threshold is located on the front passenger seat</li><li>• even when the front passenger seat is not occupied</li></ul>



Display messages	Possible causes/consequences and ► Solutions
	<p>The system may detect objects or forces that are adding to the weight applied to the seat.</p> <p><b>▲ WARNING</b> Risk of injury or death when using a child restraint system while the front passenger airbag is enabled</p> <p>If you secure a child in a child restraint system on the front passenger seat and the front passenger airbag is enabled, the front passenger airbag can deploy in the event of an accident. The child could be struck by the airbag.</p> <p>► Ensure, both before and during the journey, that the status of the front passenger airbag is correct.</p> <p>NEVER use a rearward facing child restraint on a seat protected by an ACTIVE AIRBAG in front of it, DEATH or SERIOUS INJURY to the CHILD can occur.</p> <p>► Stop the vehicle immediately in accordance with the traffic conditions.</p> <p>► Make sure that no objects are trapped under the front passenger seat.</p> <p>► Check the status of the automatic front passenger air bag shutoff (→ page 41).</p> <p>► If necessary, consult a qualified specialist workshop immediately.</p>
Occupant Presence Reminder Inoperative	<p>* The occupant presence reminder is malfunctioning</p> <p>► Consult a qualified specialist workshop.</p>

Display messages	Possible causes/consequences and ► Solutions
 <p data-bbox="144 339 386 389">Do Not Leave People or Animals in the Vehicle</p>	<p data-bbox="473 249 1618 298">* The occupant presence reminder suspects that there are persons or animals in the rear passenger compartment of the vehicle.</p> <ul data-bbox="495 308 1203 334" style="list-style-type: none"><li data-bbox="495 308 1203 334">► Do not leave any persons or animals behind when leaving the vehicle.</li></ul>



### SmartKey





Display messages	Possible causes/consequences and ► Solutions
 <p data-bbox="144 636 325 663">Obtain a New Key</p>	<p data-bbox="473 545 717 572">* Have the key replaced.</p> <ul data-bbox="495 583 916 609" style="list-style-type: none"><li data-bbox="495 583 916 609">► Consult a qualified specialist workshop.</li></ul>
 <p data-bbox="144 774 349 801">Replace Key Battery</p>	<p data-bbox="473 684 787 711">* The key battery is discharged.</p> <ul data-bbox="495 722 861 747" style="list-style-type: none"><li data-bbox="495 722 861 747">► Replace the battery (→ page 71).</li></ul>

Display messages	Possible causes/consequences and ► Solutions
 <p data-bbox="195 342 445 394">Key Not Detected (white display message)</p>	<p data-bbox="522 249 857 273">* The key is currently undetected.</p> <ul style="list-style-type: none"> <li data-bbox="543 283 1018 307">► Change the location of the key in the vehicle.</li> <li data-bbox="543 318 805 341">► Try to start the vehicle.</li> <li data-bbox="543 352 1434 376">► If the key is still not detected, place it in the slot for starting with the key (→ page 138).</li> <li data-bbox="543 386 746 410">► Start the vehicle.</li> </ul>
 <p data-bbox="195 522 463 573">Key Not Detected (red display message)</p>	<p data-bbox="522 428 1400 452">* The key can no longer be detected during a journey and may no longer be in the vehicle.</p> <p data-bbox="543 463 1190 486">If the key is no longer in the vehicle and you switch off the vehicle:</p> <ul style="list-style-type: none"> <li data-bbox="552 497 925 521">• You can no longer start the vehicle.</li> <li data-bbox="552 531 944 555">• You cannot centrally lock the vehicle.</li> </ul> <p data-bbox="543 576 931 599">► Ensure that the key is in the vehicle.</p> <p data-bbox="543 625 1031 649">If the key is in the vehicle and is still not detected:</p> <ul style="list-style-type: none"> <li data-bbox="543 659 1264 683">► Stop the vehicle immediately in accordance with the traffic conditions.</li> <li data-bbox="543 694 1308 717">► Place the key in the slot for starting the engine with the key (→ page 138).</li> </ul> <p data-bbox="543 743 918 767">The key battery is weak or discharged.</p> <ul style="list-style-type: none"> <li data-bbox="543 778 1134 801">► Check the battery using the indicator lamp (→ page 69).</li> <li data-bbox="543 812 1077 836">► Replace the key battery, if necessary (→ page 71).</li> </ul>

Display messages	Possible causes/consequences and ► Solutions
 <p>Initializing Key Please Wait</p>	<ul style="list-style-type: none"><li>* The vehicle is processing in order to teach in the new key.<ul style="list-style-type: none"><li>► Wait until processing is complete.</li></ul></li></ul>
 <p>Don't Forget Your Key</p>	<ul style="list-style-type: none"><li>* A warning tone will also sound. This message reminds you to take your key with you when you leave the vehicle.</li></ul>
<p>Place the Key in the Marked Space See Operator's Manual</p>	<ul style="list-style-type: none"><li>* Key detection is malfunctioning.<ul style="list-style-type: none"><li>► Change the location of the key in the vehicle.</li><li>► Place the key in the slot for starting the engine with the key (→ page 138).</li></ul></li></ul>

## Lights

Display messages	Possible causes/consequences and ► Solutions
 <p data-bbox="194 383 360 440">Check Left Low Beam (example)</p>	<ul style="list-style-type: none"> <li data-bbox="517 290 1025 315">* The corresponding light source is malfunctioning.               <ul style="list-style-type: none"> <li data-bbox="545 326 757 352">► Drive on carefully.</li> <li data-bbox="545 357 1081 383">► Consult a qualified specialist workshop immediately.</li> </ul> </li> <li data-bbox="545 388 1690 445">ⓘ LED light sources: the display message for the corresponding light appears only when all the light-emitting diodes in the light are faulty.</li> </ul>
 <p data-bbox="194 554 434 606">Malfunction See Operator's Manual</p>	<ul style="list-style-type: none"> <li data-bbox="517 461 914 486">* The exterior lighting is malfunctioning.               <ul style="list-style-type: none"> <li data-bbox="545 492 960 518">► Consult a qualified specialist workshop.</li> </ul> </li> </ul>
 <p data-bbox="194 720 443 771">Automatic Driving Lights Inoperative</p>	<ul style="list-style-type: none"> <li data-bbox="517 626 1136 652">* The light sensor for automatic driving lights is malfunctioning.               <ul style="list-style-type: none"> <li data-bbox="545 657 960 683">► Consult a qualified specialist workshop.</li> </ul> </li> </ul>

Display messages	Possible causes/consequences and ► Solutions
 <p data-bbox="144 342 417 389">Active Headlamps Inoperative</p>	<ul style="list-style-type: none"><li>* The active headlamps are malfunctioning.<ul style="list-style-type: none"><li>► Consult a qualified specialist workshop.</li></ul></li></ul>
 <p data-bbox="144 511 362 534">Switch On Headlights</p>	<ul style="list-style-type: none"><li>* You are driving without low-beam headlamps.<ul style="list-style-type: none"><li>► Turn the light switch to the  or <b>AUTO</b> position.</li></ul></li></ul>
 <p data-bbox="144 650 317 673">Switch Off Lights</p>	<ul style="list-style-type: none"><li>* You are leaving the vehicle and the lights are still switched on.<ul style="list-style-type: none"><li>► Turn the light switch to the <b>AUTO</b> position.</li></ul></li></ul>
 <p data-bbox="144 789 421 836">Dynamic Low Beam Inoperative</p>	<ul style="list-style-type: none"><li>* The Dynamic Low Beam is malfunctioning. The lighting system continues to function properly without the functions of the Dynamic Low Beam.<ul style="list-style-type: none"><li>► Consult a qualified specialist workshop.</li></ul></li></ul>



Display messages	Possible causes/consequences and ► Solutions
<p>Adaptive Highbeam Assist Currently Unavailable See Operator's Manual</p>	<p>* Adaptive Highbeam Assist is temporarily unavailable. The system limits have been reached (→ page 123). Once the cause of the problem is no longer present, the system will be available again. The <b>Adaptive Highbeam Assist Now Available</b> display message will appear.</p> <ul style="list-style-type: none"> <li>► Drive on.</li> <li>► Operate the high beam manually until Adaptive Highbeam Assist is available again.</li> </ul>
<p>Adaptive Highbeam Assist Inoperative</p>	<p>* Adaptive Highbeam Assist is malfunctioning.</p> <ul style="list-style-type: none"> <li>► Drive on</li> </ul> <p>or</p> <ul style="list-style-type: none"> <li>► Stop the vehicle in accordance with the traffic conditions and restart the vehicle.</li> <li>► If the display message does not disappear: consult a qualified specialist workshop.</li> <li>► Until then, operate the high beam manually.</li> </ul>
<p>Hazard Warning Light Mal- function</p>	<p>* The hazard warning lamp switch is malfunctioning.</p> <ul style="list-style-type: none"> <li>► Consult a qualified specialist workshop.</li> </ul>

### Drive system



Display messages	Possible causes/consequences and ► Solutions
<p>Reduced Drive System Performance See Operator's Manual</p>	<ul style="list-style-type: none"> <li>* The drive system switches to emergency operation mode due to a malfunction.                             <ul style="list-style-type: none"> <li>► Drive on carefully.</li> <li>► Consult a qualified specialist workshop.</li> </ul> </li> </ul>



### Vehicle



Display messages	Possible causes/consequences and ► Solutions
	<ul style="list-style-type: none"> <li>* The driver's display is inoperative due to a failed software update. The display message will be shown every time the engine is started.</li> </ul> <div style="border: 1px solid gray; padding: 5px; margin-top: 10px;"> <p><b>▲ WARNING</b> Risk of accident if the driver display fails</p> <p>If the driver display has failed or is malfunctioning, function restrictions in systems relevant to safety cannot be detected.</p> <p>The operating safety of your vehicle may be impaired.</p> <ul style="list-style-type: none"> <li>► Drive on carefully.</li> <li>► Have the vehicle checked immediately at a qualified specialist workshop.</li> </ul> </div> <p>If the operating safety of your vehicle is impaired, park the vehicle immediately and safely. Contact a qualified specialist workshop.</p>

Display messages	Possible causes/consequences and ► Solutions
	<p>If the driver's display fails, you may not recognize function restrictions affecting systems relevant to safety or the speed display, for example. The operating safety of the vehicle may be impaired (→ page 236).</p> <ul style="list-style-type: none"> <li>► Have the vehicle checked by a qualified specialist workshop immediately.</li> </ul>
<p>Cannot Start Vehicle See Operator's Manual</p>	<ul style="list-style-type: none"> <li>* The vehicle cannot be started. <ul style="list-style-type: none"> <li>► Switch the vehicle off and switch it back on.</li> <li>► If the display message still appears, consult a qualified specialist workshop.</li> </ul> </li> <li>* <b>Vehicles with 48 V on-board electrical system:</b> the state of charge of the 48 V battery is too low. You can no longer start the vehicle. <ul style="list-style-type: none"> <li>► Switch off electrical consumers that are not required.</li> <li>► Connect a suitable charger approved for Mercedes-Benz with sufficient charging power to the jump-start connection point of the 12 V battery (→ page 303). The 48 V battery is charged via the voltage converter in the vehicle.</li> </ul> </li> </ul>
<p>Vehicle Ready to Drive Shutdown Occurs When Locked or After a Few Minutes</p>	<ul style="list-style-type: none"> <li>* You are leaving the vehicle in a ready-to-drive state. <ul style="list-style-type: none"> <li>► Get out of the vehicle, secure it against rolling away and take the key with you.</li> <li>► If you do not leave the vehicle, switch off the electrical consumers, e.g. the seat heating. Otherwise, the 12-V battery may discharge and starting the engine may be possible only with the help of a second battery (starting assistance).</li> </ul> </li> </ul>

Display messages	Possible causes/consequences and ► Solutions
<p>Vehicle Ready to Drive Shutdown Occurs When Locked or Automatically in XX Mins</p>	<ul style="list-style-type: none"> <li>* You are about to leave the vehicle and the engine is running. The vehicle will switch off automatically in 20 minutes. ► To prevent the vehicle from switching off automatically, confirm the message in the central display of the multimedia system.</li> <li>* You are in the vehicle. Park position <b>P</b> is engaged and the engine is running. After a certain time of being at a standstill, this display message will appear in the driver's display. The vehicle will then be automatically switched off after a total parked time of 20 minutes. ► To prevent the vehicle from switching off automatically, confirm the message in the central display of the multimedia system.</li> </ul>
<p>Head-up Display Currently Unavailable See Operator's Manual</p>	<ul style="list-style-type: none"> <li>* The head-up display is temporarily unavailable. Possible causes are:               <ul style="list-style-type: none"> <li>• malfunctions in the power supply</li> <li>• signal interference</li> </ul> </li> <li>► Stop in accordance with the traffic conditions and switch the vehicle off and on again.</li> <li>► If the display message still appears, consult a qualified specialist workshop.</li> </ul>
<p>Head-up Display Inoperative</p>	<ul style="list-style-type: none"> <li>* The head-up display has an internal error. ► Consult a qualified specialist workshop.</li> </ul>

Display messages	Possible causes/consequences and ► Solutions
 <p>Steering Malfunction Increased Physical Effort See Operator's Manual</p>	<p>* The power steering assistance is malfunctioning.</p> <p><b>▲ WARNING</b> Risk of an accident due to altered steering characteristics</p> <p>If the power assistance of the steering fails partially or completely, you will need to use more force to steer.</p> <ul style="list-style-type: none"> <li>▶ If safe steering is possible, drive on carefully.</li> <li>▶ Visit or consult a qualified specialist workshop immediately.</li> </ul>
 <p>Steering Malfunction Stop Immediately See Operator's Manual</p>	<p>* The steering is malfunctioning. Steering capability is significantly impaired.</p> <p><b>▲ WARNING</b> Risk of accident if steering capability is impaired</p> <p>If the steering does not function as intended, the vehicle's operating safety is jeopardized.</p> <ul style="list-style-type: none"> <li>▶ Pull over and stop the vehicle safely as soon as possible, paying attention to road and traffic conditions. Do not continue driving under any circumstances.</li> <li>▶ Consult a qualified specialist workshop.</li> </ul>
 <p>Steering Malfunction See Operator's Manual</p>	<p>* The electric steering lock is malfunctioning. The steering may be locked by the electric steering lock.</p> <p><b>▲ WARNING</b> Risk of accident if steering capability is impaired</p> <p>If the steering does not function as intended, the vehicle's operating safety is jeopardized.</p>

Display messages	Possible causes/consequences and ► Solutions
	<ul style="list-style-type: none"> <li>► Pull over and stop the vehicle safely as soon as possible, paying attention to road and traffic conditions. Do not continue driving under any circumstances.</li> <li>► Consult a qualified specialist workshop.</li> </ul> <ul style="list-style-type: none"> <li>► Stop the vehicle immediately in accordance with the traffic conditions. Do not continue driving.</li> <li>► Consult a qualified specialist workshop.</li> </ul>
 <p data-bbox="144 539 423 588">Turn Steering Wheel Before Starting Vehicle</p>	<ul style="list-style-type: none"> <li>* The electric steering lock could not unlock the steering. <ul style="list-style-type: none"> <li>► Switch off the vehicle.</li> <li>► To unlock the steering, move the steering wheel slightly to the left and right.</li> <li>► Switch on the vehicle again.</li> </ul> </li> </ul>
	<ul style="list-style-type: none"> <li>* At least one door is open. <ul style="list-style-type: none"> <li>► Close all doors.</li> </ul> </li> </ul>
	<ul style="list-style-type: none"> <li>* The hood is open. <div style="border: 1px solid black; background-color: #e0e0e0; padding: 5px; margin-top: 10px;"> <p><b>▲ WARNING</b> Risk of accident due to driving with the hood unlocked</p> <p>The hood may open and block your view.</p> </div> </li> </ul>

Display messages	Possible causes/consequences and ► Solutions
	<ul style="list-style-type: none"> <li>▶ Never release the hood when driving.</li> <li>▶ Before every trip, ensure that the hood is locked.</li> </ul> <ul style="list-style-type: none"> <li>▶ Stop the vehicle immediately in accordance with the traffic conditions.</li> <li>▶ Close the hood.</li> </ul>
	<p>* The trunk lid is open.</p> <div style="background-color: #f0f0f0; padding: 5px; border: 1px solid #ccc;"> <p><b>⚠ DANGER</b> Risk of exhaust gas poisoning</p> <p>Combustion engines emit poisonous exhaust gases such as carbon monoxide. Exhaust gases can enter the vehicle interior if the trunk lid is open when the engine is running, especially if the vehicle is in motion.</p> <ul style="list-style-type: none"> <li>▶ Always switch off the engine before opening the trunk lid.</li> <li>▶ Never drive with the trunk lid open.</li> </ul> </div> <ul style="list-style-type: none"> <li>▶ Close the trunk lid.</li> </ul>
 <p>Add Washer Fluid</p>	<p>* The washer fluid level in the washer fluid reservoir has dropped below the minimum.</p> <ul style="list-style-type: none"> <li>▶ Add washer fluid (→ page 280).</li> </ul>



## 374 Display messages and warning/indicator lamps

Display messages	Possible causes/consequences and ► Solutions
Windshield Wiper Malfunction	<ul style="list-style-type: none"><li>* The windshield wiper is malfunctioning.<ul style="list-style-type: none"><li>► Restart the vehicle.</li></ul></li></ul> <p>If the display message still appears:</p> <ul style="list-style-type: none"><li>► Consult a qualified specialist workshop.</li></ul>

## Engine

Display messages	Possible causes/consequences and ► Solutions
To Switch Off Vehicle Press and Hold Start/Stop Button for at Least 3 Sec- onds or Press 3 Times	<ul style="list-style-type: none"><li>* You have pressed the start/stop button while the vehicle is in motion.<ul style="list-style-type: none"><li>► Information about switching off the vehicle while driving (→ page 137).</li></ul></li></ul>
 Check Coolant Level See Operator's Manual	<ul style="list-style-type: none"><li>* The coolant level is too low.<div data-bbox="500 707 1648 793" style="border: 1px solid black; padding: 5px;"><p><b>!</b> <b>NOTE</b> Engine damage due to insufficient coolant</p><ul style="list-style-type: none"><li>► Avoid long journeys with insufficient coolant.</li></ul></div><ul style="list-style-type: none"><li>► Add coolant (→ page 279).</li><li>► Have the engine cooling system checked at a qualified specialist workshop.</li></ul></li></ul>



Display messages	Possible causes/consequences and ► Solutions
 <p data-bbox="195 342 443 389">Coolant Stop Switch Off Vehicle</p>	<p data-bbox="524 249 765 270">* The coolant is too hot.</p> <ul style="list-style-type: none"> <li data-bbox="543 283 1406 304">► Stop immediately in accordance with the traffic conditions and switch off the vehicle.</li> </ul> <div data-bbox="543 332 1700 591" style="border: 1px solid gray; padding: 5px;"> <p data-bbox="559 342 1073 363"><b>⚠ WARNING</b> Risk of burns when opening the hood</p> <p data-bbox="559 384 1655 436">If you open the hood in the event of an overheated engine or fire in the engine compartment, the following situations may occur:</p> <ul style="list-style-type: none"> <li data-bbox="569 451 1014 472">• You may come into contact with hot gases.</li> <li data-bbox="569 482 1258 503">• You may come into contact with other escaping hot operating fluids.</li> </ul> <ul style="list-style-type: none"> <li data-bbox="559 524 1147 544">► Before opening the hood, allow the engine to cool down.</li> <li data-bbox="559 555 1522 576">► In the event of a fire in the engine compartment, keep the hood closed and call the fire service.</li> </ul> </div> <ul style="list-style-type: none"> <li data-bbox="543 612 957 632">► Wait until the engine has cooled down.</li> <li data-bbox="543 643 1184 664">► Make sure that the air supply to the radiator is not obstructed.</li> <li data-bbox="543 674 1674 726">► Avoiding high loads on the engine, drive to the nearest qualified specialist workshop. In doing so, ensure that the coolant temperature display remains below the red marking.</li> </ul>
 <p data-bbox="195 840 325 860">Fuel Reserve</p>	<p data-bbox="524 746 1045 767">* The fuel supply has dropped into the reserve range.</p> <ul style="list-style-type: none"> <li data-bbox="543 781 648 801">► Refuel.</li> </ul>

Display messages	Possible causes/consequences and ► Solutions
 <p>Fuel Filler Cap Open</p>	<p>* The fuel filler cap is not closed correctly or the fuel system is leaking.</p> <ul style="list-style-type: none"> <li>► Close the fuel filler cap.</li> <li>► <b>If the fuel filler cap was already properly closed:</b> consult a qualified specialist workshop.</li> </ul>



### Transmission

Display messages	Possible causes/consequences and ► Solutions
<p>Shift to P Only When Vehicle Is Stationary</p>	<p>* It is possible to select the park position <b>P</b> only if the vehicle is stationary.</p> <ul style="list-style-type: none"> <li>► Depress the brake pedal to stop.</li> <li>► Shift the transmission to park position <b>P</b> when the vehicle is stationary.</li> </ul>
<p>Depress Brake to Shift from P</p>	<p>* You have attempted to shift the transmission out of park position <b>P</b> and into another transmission position.</p> <ul style="list-style-type: none"> <li>► Depress the brake pedal.</li> <li>► Select transmission position <b>D</b>, <b>R</b> or neutral <b>N</b>.</li> </ul>
<p>To Deselect P or N Depress Brake and Start Vehicle</p>	<p>* You have attempted to shift the transmission out of park position <b>P</b> or neutral <b>N</b> and into another transmission position.</p> <ul style="list-style-type: none"> <li>► Depress the brake pedal.</li> <li>► Start the vehicle.</li> </ul>

Display messages	Possible causes/consequences and ► Solutions
	<ul style="list-style-type: none"> <li>► Change the transmission position.</li> </ul>
Depress Brake to Shift to D or R	<ul style="list-style-type: none"> <li>* You have attempted to select transmission position <b>D</b> or <b>R</b>.               <ul style="list-style-type: none"> <li>► Depress the brake pedal.</li> <li>► Select transmission position <b>D</b> or <b>R</b>.</li> </ul> </li> </ul>
Depress Brake to Shift to R	<ul style="list-style-type: none"> <li>* You have attempted to select transmission position <b>R</b>.               <ul style="list-style-type: none"> <li>► Depress the brake pedal.</li> <li>► Select transmission position <b>R</b>.</li> </ul> </li> </ul>
Service Required Apply Parking Brake to Park	<ul style="list-style-type: none"> <li>* A malfunction has occurred in the emergency power supply to park position <b>P</b>.               <ul style="list-style-type: none"> <li>► Consult a qualified specialist workshop.</li> <li>► Until then, always select park position <b>P</b> manually before you switch off the vehicle.</li> <li>► Before leaving the vehicle, apply the electric parking brake.</li> </ul> </li> </ul>
Risk of Vehicle Rolling Away Driver's Door Open Position P Not Selected	<ul style="list-style-type: none"> <li>* The driver's door is not fully closed and transmission position <b>D</b>, <b>R</b> or neutral <b>N</b> is selected. The vehicle may roll away.               <ul style="list-style-type: none"> <li>► Select park position <b>P</b> when switching off the vehicle.</li> </ul> </li> </ul>
Risk of Vehicle Rolling Away Apply Parking Brake When Parking	<ul style="list-style-type: none"> <li>* The transmission is malfunctioning. Park position <b>P</b> cannot be selected.               <ul style="list-style-type: none"> <li>► Park the vehicle safely.</li> <li>► Use the electric parking brake to secure the vehicle against rolling away.</li> </ul> </li> </ul>





### 378 Display messages and warning/indicator lamps









Display messages	Possible causes/consequences and ► Solutions
N Permanently Active Risk of Rolling Away	<ul style="list-style-type: none"><li>► On gradients, turn the front wheels so that the vehicle will roll towards the curb if it starts moving.</li></ul> <p>* Neutral <b>N</b> has been engaged while the vehicle is moving or while you are driving.</p> <ul style="list-style-type: none"><li>► Depress the brake pedal to stop.</li><li>► Shift the transmission to park position <b>P</b> when the vehicle is stationary.</li><li>► To continue driving, select transmission position <b>D</b> or <b>R</b>.</li></ul>
Reversing Not Possible Service Required	<p>* The transmission is malfunctioning. It is not possible to select transmission position <b>R</b>.</p> <ul style="list-style-type: none"><li>► Consult a qualified specialist workshop.</li></ul>
Transmission Malfunction Stop	<p>* The transmission is malfunctioning. The transmission shifts to neutral <b>N</b> automatically.</p> <ul style="list-style-type: none"><li>► Stop the vehicle immediately in accordance with the traffic conditions.</li><li>► Depress the brake pedal.</li><li>► Engage park position <b>P</b>.</li><li>► Consult a qualified specialist workshop.</li></ul>
Service Required Do Not Change Transmission Position	<p>* The transmission is malfunctioning. It is no longer possible to change the transmission position.</p> <ul style="list-style-type: none"><li>► If transmission position <b>D</b> is selected, consult a qualified specialist workshop and do not change the transmission position.</li><li>► For all other transmission positions, park the vehicle safely.</li><li>► Consult a qualified specialist workshop or breakdown service.</li></ul>

Display messages	Possible causes/consequences and ► Solutions
<p>Transmission Malfunction</p>	<ul style="list-style-type: none"> <li>* The transmission is malfunctioning. The cause could be an overheated clutch or blocked gears.               <ul style="list-style-type: none"> <li>► Let the transmission cool down.</li> <li>► If the display message still appears following a restart, consult a qualified specialist workshop.</li> </ul> </li> </ul>
<div style="text-align: center;">  </div> <p>Transmission Oil Overheated Drive with Caution</p>	<ul style="list-style-type: none"> <li>* The transmission is overheating. When the display message is active, start-up and driving characteristics may be temporarily impaired.               <ul style="list-style-type: none"> <li>► Drive at low engine speed.</li> <li>► Avoid sporty driving.</li> <li>► Before pulling away on uphill gradients, let the transmission cool down until the display message disappears.</li> </ul> </li> </ul>
<div style="text-align: center;">  </div> <p>Parking Lock Inoperative Apply Parking Brake</p>	<ul style="list-style-type: none"> <li>* The transmission is malfunctioning. Park position <b>P</b> cannot be selected.               <ul style="list-style-type: none"> <li>► Park the vehicle safely.</li> <li>► Use the electric parking brake to secure the vehicle against rolling away.</li> </ul> </li> </ul>
<p>Teaching in Transmission Operate Selector Lever Apply Brake for XX s Risk of Vehicle Rolling Away</p>	<ul style="list-style-type: none"> <li>* The transmission is being taught in. There is a risk of the vehicle rolling away.               <ul style="list-style-type: none"> <li>► Depress and hold the brake pedal until the teach-in process has been completed. The electric parking brake will be applied automatically during the teach-in procedure.</li> <li>► Switch on the vehicle.</li> <li>► Select park position <b>P</b>, transmission position <b>R</b> or neutral <b>N</b>.</li> </ul> </li> </ul>

Display messages	Possible causes/consequences and ► Solutions
Teaching in Transmission Complete	* The transmission's teach-in process is complete. All transmission positions can be selected again.
Transmission Malfunction Service Required	* The transmission is malfunctioning. Consult a qualified specialist workshop.
Auxiliary Battery Malfunction (white display message)	* There is a malfunction in the auxiliary battery. ► Consult a qualified specialist workshop. ► Until then, always select park position <b>P</b> manually before you switch off the vehicle. ► Before leaving the vehicle, apply the electric parking brake.
Auxiliary Battery Malfunction (red display message)	* There is a malfunction in the auxiliary battery. ► Consult a qualified specialist workshop. ► Until then, always select park position <b>P</b> manually before you switch off the vehicle. ► Before leaving the vehicle, apply the electric parking brake.









## Brakes



Display messages	Possible causes/consequences and ► Solutions
<div data-bbox="203 295 360 378" data-label="Image"> </div> <p data-bbox="203 383 304 409">(USA only)</p> <div data-bbox="203 419 360 502" data-label="Image"> </div> <p data-bbox="203 507 341 533">(Canada only)</p> <p data-bbox="194 543 462 595">Parking Brake See Operator's Manual</p>	<ul style="list-style-type: none"> <li data-bbox="526 290 1339 315">* The yellow  indicator lamp is lit. The electric parking brake is malfunctioning.               <ul style="list-style-type: none"> <li data-bbox="545 326 637 352"><b>To apply:</b></li> <li data-bbox="545 357 1007 383">► Switch the vehicle off and switch it back on.</li> <li data-bbox="545 388 1136 419">► Apply the electric parking brake manually (→ page 164).</li> </ul> <p data-bbox="545 445 1071 471">If it is not possible to apply the electric parking brake:</p> <ul style="list-style-type: none"> <li data-bbox="545 476 970 502">► Consult a qualified specialist workshop.</li> <li data-bbox="545 507 1256 538">► Where necessary, also secure the parked vehicle against rolling away.</li> </ul> </li> <li data-bbox="526 549 1690 600">* The yellow  indicator lamp and the red  (USA only) or  (Canada only) indicator lamp are lit. The electric parking brake is malfunctioning.               <ul style="list-style-type: none"> <li data-bbox="545 611 656 637"><b>To release:</b></li> <li data-bbox="545 642 1007 668">► Switch the vehicle off and switch it back on.</li> <li data-bbox="545 673 1155 704">► Release the electric parking brake manually (→ page 164).</li> </ul> <p data-bbox="545 714 572 740">or</p> <ul style="list-style-type: none"> <li data-bbox="545 745 1201 777">► Release the electric parking brake automatically (→ page 164).</li> </ul> <p data-bbox="545 777 1127 802">If it is still not possible to release the electric parking brake:</p> <ul style="list-style-type: none"> <li data-bbox="545 808 1210 839">► Do not continue driving. Consult a qualified specialist workshop.</li> </ul> </li> </ul>

Display messages	Possible causes/consequences and ► Solutions
	<p>* The yellow  indicator lamp is lit and the red  (USA only) or  (Canada only) indicator lamp is flashing. The electric parking brake is malfunctioning.</p> <p>The electric parking brake could not be applied or released.</p> <ul style="list-style-type: none"><li>► Switch the vehicle off and switch it back on.</li></ul> <p><b>To apply:</b></p> <ul style="list-style-type: none"><li>► Release and then apply the electric parking brake manually (→ page 164).</li></ul> <p><b>To release:</b></p> <ul style="list-style-type: none"><li>► Apply and then release the electric parking brake manually.</li></ul> <p>If the electric parking brake cannot be applied or the red  (USA only) or  (Canada only) indicator lamp continues to flash:</p> <ul style="list-style-type: none"><li>► Do not continue driving. Consult a qualified specialist workshop.</li><li>► Where necessary, also secure the parked vehicle against rolling away.</li></ul> <p>* The yellow  indicator lamp is lit and the red  (USA only) or  (Canada only) indicator lamp flashes for approximately ten seconds after the electric parking brake has been applied or released. It then remains lit or goes out. The electric parking brake is malfunctioning.</p> <p><b>If the state of charge is too low:</b></p> <ul style="list-style-type: none"><li>► Charge the 12 V battery.</li></ul>





Display messages	Possible causes/consequences and ► Solutions
	<p><b>To apply:</b></p> <ul style="list-style-type: none"><li>► Switch off the vehicle. The electric parking brake will be applied automatically.</li></ul> <p>If you do not want the electric parking brake to be applied, e.g. at an automatic car wash or when the vehicle is being towed, leave the vehicle switched on. This does not include having the vehicle towed with the rear axle raised.</p> <p>If the electric parking brake is not applied automatically:</p> <ul style="list-style-type: none"><li>► Switch the vehicle off and switch it back on.</li><li>► Release and then apply the electric parking brake manually (→ page 164).</li></ul> <p>If it is still not possible to apply the electric parking brake:</p> <ul style="list-style-type: none"><li>► Consult a qualified specialist workshop.</li><li>► Where necessary, also secure the parked vehicle against rolling away.</li></ul> <p><b>To release:</b></p> <ul style="list-style-type: none"><li>► If the conditions for automatic release are fulfilled and the electric parking brake is not released automatically, release the electric parking brake manually (→ page 164).</li></ul> <p>If it is still not possible to release the electric parking brake:</p> <ul style="list-style-type: none"><li>► Do not continue driving. Consult a qualified specialist workshop.</li></ul>

Display messages	Possible causes/consequences and ► Solutions
 <p>(USA only)</p>  <p>(Canada only)</p> <p>Release Parking Brake</p>	<p>* The red  indicator lamp (USA only) or  indicator lamp (Canada only) is flashing.</p> <p>The electric parking brake is applied while you are driving:</p> <ul style="list-style-type: none"><li>• A condition for automatic release of the electric parking brake has not been fulfilled (→ page 164).</li><li>• You are performing emergency braking using the electric parking brake (→ page 165).</li></ul> <p>► Check the conditions for automatic release of the electric parking brake.</p> <p>► Release the electric parking brake manually.</p>
 <p>(USA only)</p>  <p>(Canada only)</p> <p>Switch on Vehicle to Release the Parking Brake</p>	<p>* The red  (USA only) or  (Canada only) indicator lamp is lit.</p> <p>You have attempted to release the electric parking brake with the vehicle switched off.</p> <p>► Switch on the vehicle.</p>

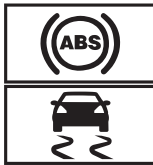

Display messages	Possible causes/consequences and ► Solutions
 <p>(USA only)</p>  <p>(Canada only)</p> <p><a href="#">Check Brake Fluid Level</a></p>	<p>* There is insufficient brake fluid in the brake fluid reservoir.</p> <div style="border: 1px solid gray; padding: 5px; margin: 5px 0;"> <p><b>▲ WARNING</b> Risk of an accident due to low brake fluid level</p> <p>If the brake fluid level is too low, the braking effect and the braking characteristics may be impaired.</p> <ul style="list-style-type: none"> <li>▶ Pull over and stop the vehicle safely as soon as possible, paying attention to road and traffic conditions. Do not continue driving under any circumstances.</li> <li>▶ Consult a qualified specialist workshop.</li> <li>▶ Do not add brake fluid.</li> </ul> </div>
<p><a href="#">Check Brake Pads See Operator's Manual</a></p>	<p>* The brakepads have reached the wear limit.</p> <ul style="list-style-type: none"> <li>▶ Consult a qualified specialist workshop.</li> </ul>

## Driving and driving safety systems

Display messages	Possible causes/consequences and ► Solutions
 <p data-bbox="144 467 408 519">Currently Unavailable See Operator's Manual</p>	<p data-bbox="476 294 912 319">* ABS and ESP® are temporarily unavailable.</p> <p data-bbox="495 329 1430 354">Other driving systems and driving safety systems (e.g. BAS) may also be temporarily unavailable.</p> <p data-bbox="495 364 1641 389">The brake system will continue to operate normally. Braking distance may increase in an emergency braking situation.</p> <div data-bbox="500 405 1646 446" style="background-color: #f0f0f0; padding: 5px;"> <p data-bbox="506 415 1166 440"><b>▲ WARNING</b> Risk of skidding if ABS and ESP® are malfunctioning</p> </div> <p data-bbox="513 456 1378 481">The wheels may lock during braking and ESP® does not perform any vehicle stabilization.</p> <p data-bbox="513 492 1600 543">The steerability and braking characteristics are heavily impaired and the braking distance may increase. In addition, other driving safety systems are switched off.</p> <ul data-bbox="513 554 1585 664" style="list-style-type: none"> <li data-bbox="513 554 1585 606">► Drive carefully on a suitable stretch of road, making slight steering movements at a speed above 19 mph (30 km/h).</li> <li data-bbox="513 616 1585 664">► If the display message does not disappear, consult a qualified specialist workshop immediately. Drive carefully.</li> </ul>

Display messages	Possible causes/consequences and ► Solutions
 <p data-bbox="194 424 471 476">Inoperative See Operator's Manual</p>	<p data-bbox="526 248 1690 347">* ABS and ESP® are malfunctioning. Other driving systems and driving safety systems (e.g. BAS) may also be malfunctioning. The brake system will continue to operate normally. Braking distance may increase in an emergency braking situation.</p> <div data-bbox="545 362 1690 580" style="border: 1px solid gray; padding: 5px;"> <p data-bbox="554 367 1681 404"><b>▲ WARNING</b> Risk of skidding if ABS and ESP® are malfunctioning</p> <p data-bbox="554 409 1681 502">The wheels may block during braking and ESP® does not perform any vehicle stabilization. The steerability and braking characteristics are heavily impaired and the braking distance may increase. In addition, other driving safety systems are switched off.</p> <ul data-bbox="554 507 1681 574" style="list-style-type: none"> <li data-bbox="554 507 1681 538">► Drive on carefully.</li> <li data-bbox="554 543 1681 574">► Have ABS and ESP® checked immediately at a qualified specialist workshop.</li> </ul> </div>
 <p data-bbox="194 688 471 740">Currently Unavailable See Operator's Manual</p>	<p data-bbox="526 595 1690 663">* ESP® is temporarily unavailable. Other driving systems and driving safety systems (e.g. BAS) may also be malfunctioning.</p> <div data-bbox="545 673 1690 839" style="border: 1px solid gray; padding: 5px;"> <p data-bbox="554 678 1681 714"><b>▲ WARNING</b> Risk of skidding if ESP is malfunctioning®</p> <p data-bbox="554 720 1681 782">If ESP® is malfunctioning, ESP® cannot carry out vehicle stabilization. In addition, other driving safety systems are switched off.</p> <ul data-bbox="554 787 1681 833" style="list-style-type: none"> <li data-bbox="554 787 1681 833">► Drive carefully on a suitable stretch of road, making slight steering movements at a speed above 19 mph (30 km/h).</li> </ul> </div>

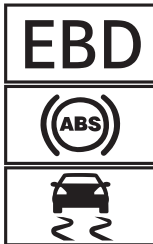
Display messages	Possible causes/consequences and ► Solutions
	<ul style="list-style-type: none"> <li>► If the display message does not disappear, consult a qualified specialist workshop immediately. Drive carefully.</li> </ul>
<div style="text-align: center;">  <p>Inoperative See Operator's Manual</p> </div>	<p>* ESP® is malfunctioning.            Other driving systems and driving safety systems (e.g. BAS) may also be malfunctioning.            The brake system will continue to operate normally. Braking distance may increase in an emergency braking situation.</p> <div style="background-color: #e0e0e0; padding: 5px;"> <p><b>▲ WARNING</b> Risk of skidding if ESP® is malfunctioning</p> </div> <p>If ESP® is malfunctioning, ESP® cannot carry out vehicle stabilization. In addition, other driving safety systems are switched off.</p> <ul style="list-style-type: none"> <li>► Drive on carefully.</li> <li>► Have ESP® checked at a qualified specialist workshop.</li> </ul>



Display messages	Possible causes/consequences and ► Solutions
 <p data-bbox="194 512 471 564">Inoperative See Operator's Manual</p>	<p data-bbox="526 248 1404 310">* EBD, ABS and ESP® are malfunctioning. Other driving systems and driving safety systems (e.g. BAS) may also be malfunctioning.</p> <div data-bbox="545 326 1690 543" style="border: 1px solid gray; padding: 5px;"> <p data-bbox="554 336 1275 367"><b>▲ WARNING</b> Risk of skidding if EBD, ABS and ESP® are malfunctioning</p> <p data-bbox="563 378 1450 409">The wheels may block during braking and ESP® does not perform any vehicle stabilization.</p> <p data-bbox="563 414 1653 466">The steerability and braking characteristics are heavily impaired and the braking distance may increase. In addition, other driving safety systems are switched off.</p> <ul data-bbox="563 471 1367 533" style="list-style-type: none"> <li data-bbox="563 471 776 502">► Drive on carefully.</li> <li data-bbox="563 507 1367 533">► Have the brake system checked immediately at a qualified specialist workshop.</li> </ul> </div>
 <p data-bbox="194 673 231 704">Off</p>	<p data-bbox="526 585 1598 616">* The HOLD function is deactivated because the vehicle is slipping or a condition for activation is not fulfilled.</p> <ul data-bbox="545 621 1635 647" style="list-style-type: none"> <li data-bbox="545 621 1635 647">► Reactivate the HOLD function later or check the activation conditions for the HOLD function (→ page 172).</li> </ul>
 <p data-bbox="194 818 471 870">ATTENTION ASSIST: Take a Break!</p>	<p data-bbox="526 725 1561 782">* ATTENTION ASSIST has detected fatigue or an increasing lack of concentration on the part of the driver (→ page 174).</p> <ul data-bbox="545 787 840 813" style="list-style-type: none"> <li data-bbox="545 787 840 813">► If necessary, take a break.</li> </ul>

Display messages	Possible causes/consequences and ► Solutions
 <p>--- mph</p>	<ul style="list-style-type: none"> <li>* Cruise control cannot be activated as not all activation conditions are fulfilled.                             <ul style="list-style-type: none"> <li>► Observe the activation conditions for cruise control (→ page 176).</li> </ul> </li> </ul>
<p>Cruise Control Inoperative</p>	<ul style="list-style-type: none"> <li>* Cruise control is malfunctioning.                             <ul style="list-style-type: none"> <li>► Consult a qualified specialist workshop.</li> </ul> </li> </ul>
<p>Cruise Control Off</p>	<ul style="list-style-type: none"> <li>* Cruise control has been deactivated.                             <p>If there is an additional warning tone, cruise control has been deactivated automatically (→ page 176).</p> </li> </ul>
<p>Traffic Sign Assist Currently Unavailable See Operator's Manual</p>	<ul style="list-style-type: none"> <li>* Traffic Sign Assist is temporarily unavailable.                             <p>Once the cause of the problem is no longer present, the system will be available again.</p> <ul style="list-style-type: none"> <li>► Continue driving in compliance with traffic regulations.</li> </ul> </li> </ul>
<p>Traffic Sign Assist Inoperative</p>	<ul style="list-style-type: none"> <li>* Traffic Sign Assist is malfunctioning.                             <ul style="list-style-type: none"> <li>► Continue driving in compliance with traffic regulations.</li> <li>or</li> <li>► Stop the vehicle in accordance with the traffic conditions and restart the vehicle.</li> <li>► If the display message does not disappear: consult a qualified specialist workshop.</li> </ul> </li> </ul>



Display messages	Possible causes/consequences and ► Solutions
 <p data-bbox="195 342 473 391">Malfunction Do Not Exceed 50 mph</p>	<ul style="list-style-type: none"> <li data-bbox="524 252 1493 275">* The adjustable damping is malfunctioning. The vehicle's handling characteristics may be affected.                             <ul style="list-style-type: none"> <li data-bbox="543 285 1119 308">► Do not drive at speeds greater than 50 mph (80 km/h).</li> <li data-bbox="543 319 962 341">► Consult a qualified specialist workshop.</li> </ul> </li> </ul>

### Driver assistance systems



Display messages	Possible causes/consequences and ► Solutions
 <p data-bbox="195 638 282 660">--- mph</p>	<ul style="list-style-type: none"> <li data-bbox="524 548 1498 570">* Active Distance Assist DISTRONIC cannot be activated as not all activation conditions are fulfilled.                             <ul style="list-style-type: none"> <li data-bbox="543 581 1461 603">► Comply with the activation conditions of Active Distance Assist DISTRONIC (→ page 180).</li> </ul> </li> </ul>
 <p data-bbox="195 780 310 802">Suspended</p>	<ul style="list-style-type: none"> <li data-bbox="524 689 1696 738">* If you depress the accelerator pedal beyond the setting of Active Distance Assist DISTRONIC, the system will switch to passive mode (→ page 178).</li> </ul>

Display messages	Possible causes/consequences and ► Solutions
 <p>Off</p>	<p>* Active Distance Assist DISTRONIC was deactivated. If a warning tone also sounds, Active Distance Assist DISTRONIC has deactivated automatically (→ page 180).</p>
<p>Active Distance Assist Currently Unavailable See Operator's Manual</p>	<p>* Active Distance Assist DISTRONIC is temporarily unavailable. The ambient conditions are outside the system limits (→ page 178). As soon as the ambient conditions are within the system limits, the system will become available again.</p> <ul style="list-style-type: none"> <li>► Drive on carefully.</li> <li>or</li> <li>► If the display message does not disappear, stop the vehicle in accordance with the traffic conditions and restart the vehicle.</li> </ul>
<p>Active Distance Assist Inoperative</p>	<p>* Active Distance Assist DISTRONIC and Active Emergency Stop Assist are malfunctioning. Other driving systems and driving safety systems may also be malfunctioning.</p> <ul style="list-style-type: none"> <li>► Drive on carefully.</li> <li>or</li> <li>► Stop the vehicle in accordance with the traffic conditions and restart the vehicle.</li> <li>► If the display message does not disappear: consult a qualified specialist workshop.</li> </ul>

Display messages	Possible causes/consequences and ► Solutions
Active Distance Assist Now Available	<ul style="list-style-type: none"> <li>* Active Distance Assist DISTRONIC is operational again.               <ul style="list-style-type: none"> <li>► Switch on Active Distance Assist DISTRONIC (→ page 180).</li> </ul> </li> </ul>
Active Brake Assist Functions Currently Limited See Operator's Manual	<ul style="list-style-type: none"> <li>* For vehicles with the Driving Assistance Package, the following functions may be temporarily unavailable or only partially available:               <ul style="list-style-type: none"> <li>• Active Brake Assist with turning maneuver function</li> <li>• Active Evasive Steering Assist</li> </ul> <p>The ambient conditions are outside the system limits (→ page 188).</p> <p><b>Vehicles without the Driving Assistance Package:</b> Active Brake Assist is temporarily unavailable.</p> <ul style="list-style-type: none"> <li>► Drive on carefully. As soon as the ambient conditions are within the system limits, the system will become available again.</li> </ul> <p>or</p> <ul style="list-style-type: none"> <li>► If the display message does not disappear, stop the vehicle in accordance with the traffic conditions and restart the vehicle.</li> </ul> </li> </ul>
Active Brake Assist Functions Limited See Operator's Manual	<ul style="list-style-type: none"> <li>* For vehicles with the Driving Assistance Package, the following functions may be temporarily unavailable or only partially available:               <ul style="list-style-type: none"> <li>• Active Brake Assist with turning maneuver function</li> <li>• Active Evasive Steering Assist</li> </ul> </li> </ul>



### 394 Display messages and warning/indicator lamps

Display messages	Possible causes/consequences and ► Solutions
	<p><b>Vehicles without the Driving Assistance Package:</b> Active Brake Assist is temporarily unavailable or only partially available.</p> <ul style="list-style-type: none"><li>► Drive on carefully.</li></ul> <p>or</p> <ul style="list-style-type: none"><li>► Stop the vehicle in accordance with the traffic conditions and restart the vehicle.</li><li>► If the display message does not disappear: consult a qualified specialist workshop.</li></ul>
<p>Active Steering Assist Currently Unavailable See Operator's Manual</p>	<p>* Active Steering Assist is temporarily unavailable. The ambient conditions are outside the system limits (→ page 185). As soon as the ambient conditions are within the system limits, the system will become available again.</p> <ul style="list-style-type: none"><li>► Drive on</li><li>► Check the tire pressure if necessary.</li></ul>
<p>Active Steering Assist Inoperative</p>	<p>* Active Steering Assist and Active Emergency Stop Assist are malfunctioning. Active Distance Assist DISTRONIC remains available.</p> <ul style="list-style-type: none"><li>► Drive on</li></ul> <p>or</p> <ul style="list-style-type: none"><li>► Stop the vehicle in accordance with the traffic conditions and restart the vehicle.</li><li>► If the display message does not disappear: consult a qualified specialist workshop.</li></ul>

Display messages	Possible causes/consequences and ► Solutions
	<ul style="list-style-type: none"> <li>* Active Steering Assist has reached the system limits (→ page 185). You have not steered independently for a considerable period of time.               <ul style="list-style-type: none"> <li>► Take over the steering and drive on in accordance with the traffic conditions.</li> </ul> </li> </ul>
<p>Active Steering Assist Currently Unavailable Due to Multiple Emergency Stops</p>	<ul style="list-style-type: none"> <li>* Active Steering Assist is temporarily unavailable due to several emergency stops having been performed.               <ul style="list-style-type: none"> <li>► Take over the steering and stop in accordance with the traffic conditions.</li> <li>► Switch the vehicle off and switch it back on Active Steering Assist is available once more.</li> </ul> </li> </ul>
 <p>Initiating Emergency Stop</p>	<ul style="list-style-type: none"> <li>* Your hands are not on the steering wheel. An emergency stop will be initiated (→ page 185).               <ul style="list-style-type: none"> <li>► Make a deliberate steering movement.</li> <li>► Accelerate or brake.</li> </ul> </li> </ul> <p>Information on canceling an emergency stop (→ page 187).</p>
<p>Blind Spot Assist Currently Unavailable See Operator's Manual</p>	<ul style="list-style-type: none"> <li>* Blind Spot Assist is temporarily unavailable. The system limits have been reached (→ page 197). Once the cause of the problem is no longer present, the system will be available again.               <ul style="list-style-type: none"> <li>► Drive on.</li> <li>or</li> <li>► If the display message does not disappear, stop the vehicle in accordance with the traffic conditions and restart the vehicle.</li> </ul> </li> </ul>

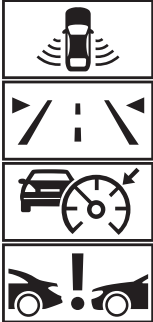
Display messages	Possible causes/consequences and ► Solutions
Blind Spot Assist Inoperative	<p>* Blind Spot Assist or the exit warning is malfunctioning.</p> <ul style="list-style-type: none"> <li>► Drive on.</li> <li>or</li> <li>► Stop the vehicle in accordance with the traffic conditions and restart the vehicle.</li> <li>► If the display message does not disappear: consult a qualified specialist workshop.</li> </ul>
Active Lane Keeping Assist Currently Unavailable See Operator's Manual	<p>* Active Lane Keeping Assist is temporarily unavailable.</p> <p>The ambient conditions are outside the system limits (→ page 198).</p> <p>As soon as the ambient conditions are within the system limits, the system will become available again.</p> <ul style="list-style-type: none"> <li>► Drive on</li> </ul>
Active Lane Keeping Assist Inoperative	<p>* Active Lane Keeping Assist and Active Emergency Stop Assist are malfunctioning.</p> <ul style="list-style-type: none"> <li>► Drive on</li> <li>or</li> <li>► Stop the vehicle in accordance with the traffic conditions and restart the vehicle.</li> <li>► If the display message does not disappear: consult a qualified specialist workshop.</li> </ul>
Active Lane Keeping Assist Limited Range of Functions See Operator's Manual	<p>* Active Lane Keeping Assist is available but restricted.</p> <ul style="list-style-type: none"> <li>► Drive on</li> <li>or</li> <li>► Stop the vehicle in accordance with the traffic conditions and restart the vehicle.</li> </ul>

Display messages	Possible causes/consequences and ► Solutions
 <p data-bbox="195 638 439 686">Temporarily Unavailable Sensors Dirty</p>	<p data-bbox="543 249 1382 275">► If the display message does not disappear: consult a qualified specialist workshop.</p> <p data-bbox="524 291 1452 317">* Front and corner radar sensors (hereafter "sensors") are malfunctioning. Possible causes are:</p> <ul data-bbox="550 329 1201 420" style="list-style-type: none"> <li data-bbox="550 329 787 355">• The sensors are dirty</li> <li data-bbox="550 363 768 389">• Heavy rain or snow</li> <li data-bbox="550 397 1201 423">• Extended country driving without other traffic, e.g. in the desert</li> </ul> <p data-bbox="543 439 1696 487">Driving systems and driving safety systems may be malfunctioning or temporarily unavailable. The brake system, steering and drive system will continue to function normally.</p> <p data-bbox="543 498 759 524">► Drive on carefully.</p> <p data-bbox="543 550 1696 598">Once the causes of the problem are no longer present, the driving systems and driving safety systems will be available again and the corresponding symbols will be switched off.</p> <p data-bbox="543 612 962 638">If the display message does not disappear:</p> <ul data-bbox="543 646 1142 737" style="list-style-type: none"> <li data-bbox="543 646 1142 672">► Stop the vehicle in accordance with the traffic conditions.</li> <li data-bbox="543 680 1088 706">► Clean all sensor covers from outside (→ page 167).</li> <li data-bbox="543 714 772 740">► Restart the vehicle.</li> </ul>

Display messages	Possible causes/consequences and ► Solutions
 <p data-bbox="144 764 421 816">Camera View Reduced See Operator's Manual</p>	<p data-bbox="476 249 1188 272">* The view of the multifunction camera is restricted. Possible causes are:</p> <ul data-bbox="500 285 1618 405" style="list-style-type: none"> <li data-bbox="500 285 1215 308">• Dirt on the windshield in the field of vision of the multifunction camera</li> <li data-bbox="500 319 759 341">• Heavy rain, snow or fog</li> <li data-bbox="500 352 1618 405">• Fogging up of the windshield from inside or outside: in certain weather conditions, fog can form on the inside or outside of the windshield during cold times of year in particular.</li> </ul> <p data-bbox="495 420 1618 472">  This fog on the windshield will be removed automatically within a short time with the aid of a heater. The restriction is temporary. </p> <p data-bbox="495 482 1646 534">Driving systems and driving safety systems may be malfunctioning or temporarily unavailable. The brake system, steering and drive system will continue to function normally.</p> <ul data-bbox="495 544 1507 638" style="list-style-type: none"> <li data-bbox="495 544 704 567">► Drive on carefully.</li> <li data-bbox="495 578 1507 600">► In order to remove the fog from the outside, carry out a single wipe of the windshield (→ page 126).</li> <li data-bbox="495 611 1212 634">► In order to remove the fog from the inside, press  (→ page 134).</li> </ul> <p data-bbox="495 664 1646 715">Once the causes of the problem are no longer present, the driving systems and driving safety systems will be available again and the corresponding symbols will be switched off.</p> <p data-bbox="495 726 1313 749">If the display message does not disappear after a longer drive of around 15 minutes:</p> <ul data-bbox="495 759 1415 852" style="list-style-type: none"> <li data-bbox="495 759 1092 782">► Stop the vehicle in accordance with the traffic conditions.</li> <li data-bbox="495 792 1415 815">► Clean the windshield, especially in the position of the multifunction camera (→ page 167).</li> <li data-bbox="495 825 717 848">► Restart the vehicle.</li> </ul>



Display messages	Possible causes/consequences and ► Solutions
PRE-SAFE Inoperative See Operator's Manual	<ul style="list-style-type: none"> <li>* The PRE-SAFE® functions are malfunctioning.               <ul style="list-style-type: none"> <li>► Consult a qualified specialist workshop.</li> </ul> </li> </ul>

### Parking assistance systems

Display messages	Possible causes/consequences and ► Solutions
PARKTRONIC Inoperative See Operator's Manual	<ul style="list-style-type: none"> <li>* Parking Assist PARKTRONIC is malfunctioning. Once the cause of the problem is no longer present, the system will be available again.               <ul style="list-style-type: none"> <li>► Continue driving while paying attention to the vehicle's surroundings.</li> <li>or</li> <li>► Stop the vehicle in accordance with the traffic conditions and restart the vehicle.</li> <li>► If the display message still appears, consult a qualified specialist workshop.</li> </ul> </li> </ul>
Active Parking Assist and PARKTRONIC Inoperative See Operator's Manual	<ul style="list-style-type: none"> <li>* Active Parking Assist and Parking Assist PARKTRONIC are malfunctioning. Once the cause of the problem is no longer present, the system will be available again.               <ul style="list-style-type: none"> <li>► Continue driving while paying attention to the vehicle's surroundings.</li> <li>or</li> <li>► Stop the vehicle in accordance with the traffic conditions and restart the vehicle.</li> <li>► If the display message still appears, consult a qualified specialist workshop.</li> </ul> </li> </ul>



### Mercedes-Benz emergency call system

Display messages	Possible causes/consequences and ► Solutions
 <p>Inoperative</p>	<p>* The Mercedes-Benz emergency call system is malfunctioning. The Mercedes me connect system is also malfunctioning.</p> <ul style="list-style-type: none"><li>► Consult a qualified specialist workshop.</li></ul>

### Battery

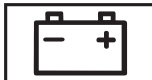
Display messages	Possible causes/consequences and ► Solutions
 <p>12 V On-board Electrical System Service Required</p>	<p>* The 12 V on-board electrical system is malfunctioning.</p> <ul style="list-style-type: none"><li>► Consult a qualified specialist workshop immediately.</li></ul>



Display messages	Possible causes/consequences and ► Solutions
 <p data-bbox="194 341 443 388">Stop Vehicle See Operator's Manual</p>	<p data-bbox="526 248 1349 274">* The 12 V battery is no longer being charged and the condition of charge is too low.</p> <div data-bbox="545 290 1690 409" style="border: 1px solid black; padding: 5px;"> <p data-bbox="554 300 1127 326"><b>!</b> <b>NOTE</b> Possible engine damage if you continue driving</p> <ul style="list-style-type: none"> <li data-bbox="563 341 1081 367">► Do not continue driving under any circumstances.</li> <li data-bbox="563 372 988 398">► Consult a qualified specialist workshop.</li> </ul> </div> <ul style="list-style-type: none"> <li data-bbox="545 429 1681 476">► Stop the vehicle immediately in accordance with the traffic conditions. Do not continue driving under any circumstances.</li> <li data-bbox="545 486 803 512">► Switch off the vehicle.</li> <li data-bbox="545 523 970 549">► Consult a qualified specialist workshop.</li> </ul>
 <p data-bbox="194 657 443 704">Switch on vehicle to charge the 12 V battery</p>	<p data-bbox="526 564 1284 590">* The vehicle is off and the condition of charge of the 12 V battery is too low.</p> <ul style="list-style-type: none"> <li data-bbox="545 595 1099 621">► Switch off electrical consumers that are not required.</li> <li data-bbox="545 626 803 652">► Drive for 30–60 mins.</li> </ul> <p data-bbox="545 663 572 683">or</p> <ul style="list-style-type: none"> <li data-bbox="545 688 1136 714">► Charge the 12 V battery when stationary (→ page 303).</li> </ul>

Display messages	Possible causes/consequences and ► Solutions
 <p data-bbox="144 339 421 418">Stop Vehicle To Charge the 12 V Battery Do Not Switch Off Vehicle</p>	<ul style="list-style-type: none"> <li data-bbox="473 249 975 273">* The state of charge of the 12 V battery is too low.</li> <li data-bbox="495 283 1452 307">► Stop the vehicle immediately in accordance with the traffic conditions. Do not continue driving.</li> <li data-bbox="495 318 778 341">► Leave the vehicle running</li> <li data-bbox="495 352 953 376">► If the display message disappears: drive on.</li> <li data-bbox="495 386 1332 410">► If the display message does not disappear: consult a qualified specialist workshop.</li> </ul>
 <p data-bbox="144 533 402 612">Battery Overheated Stop! Everyone Get Out! Outdoors if Possible</p>	<ul style="list-style-type: none"> <li data-bbox="473 443 1014 467">* The 48 V battery is overheating. There is a risk of fire.</li> <li data-bbox="495 477 1212 501">► Stop the vehicle immediately in accordance with the traffic conditions.</li> <li data-bbox="495 511 1387 535">► If possible, stop the vehicle in the open air and ensure that all vehicle occupants get out.</li> <li data-bbox="495 545 1600 569">◉ Supporting vehicle functions may activate automatically, e.g. air-recirculation mode as part of climate control.</li> <li data-bbox="495 580 765 603">► Do not continue driving.</li> <li data-bbox="495 614 1300 638">► If smoke is present, leave the danger zone and call the fire service immediately.</li> <li data-bbox="495 648 1332 672">► Consult a qualified specialist workshop even if there are no external signs of a fire.</li> </ul>
 <p data-bbox="144 785 389 840">48 V Battery See Operator's Manual</p>	<ul style="list-style-type: none"> <li data-bbox="473 695 1092 718">* The 48 V on-board electrical system has function restrictions.</li> <li data-bbox="495 729 1208 753">Comfort functions, such as the climate control system, may be restricted.</li> <li data-bbox="495 763 809 787">It is possible to continue driving.</li> <li data-bbox="495 797 1535 821">► If the display message remains active continuously, consult a qualified specialist workshop immediately.</li> </ul>



Display messages	Possible causes/consequences and ► Solutions
 <p data-bbox="195 339 463 391">Please Wait Charging 48 V Battery...</p>	<p data-bbox="524 249 1652 301">* The 48 V battery is discharged. You have switched on the vehicle while the 12 V battery was being charged with a suitable charger or while another vehicle was providing starting assistance.</p> <p data-bbox="543 308 1689 360">The discharged 48 V battery is charged automatically via the voltage converter. After a few minutes, the <b>Starting Possible Again</b> display message will be shown on the driver's display.</p> <ul style="list-style-type: none"> <li data-bbox="543 367 746 398">► Start the vehicle.</li> <li data-bbox="543 406 1683 457">► Drive the vehicle for a while to charge the 12 V battery and the 48 V battery after disconnecting the charger from the vehicle.</li> </ul> <p data-bbox="543 481 1361 512">If the <b>Starting Possible Again</b> display message does not appear after a few minutes:</p> <ul style="list-style-type: none"> <li data-bbox="543 520 805 551">► Try to start the vehicle.</li> <li data-bbox="543 558 1240 589">► If the vehicle does not start, consult a qualified specialist workshop.</li> </ul>
<p data-bbox="195 591 430 617"><b>Starting Possible Again</b></p>	<p data-bbox="524 591 1273 622">* The 48 V battery has been charged automatically via the voltage converter.</p> <ul style="list-style-type: none"> <li data-bbox="543 629 1417 660">► Start the vehicle and drive for a while to charge the 12 V battery and the 48 V battery.</li> </ul>

### Tire pressure monitor

Display messages	Possible causes/consequences and ► Solutions
<p data-bbox="195 797 463 849"><b>Tire Pressure Monitor Currently Unavailable</b></p>	<p data-bbox="524 797 1652 849">* There is interference from a powerful radio signal source. As a result, no signals from the tire pressure sensor are being received. The tire pressure monitoring system is temporarily unavailable.</p> <p data-bbox="543 856 1535 887">The tire pressure monitoring system will restart automatically as soon as the cause has been rectified.</p>

Display messages	Possible causes/consequences and ► Solutions
<p>Tire Pressure Monitor Inoperative</p>	<p>► Drive on.</p> <p>* The tire pressure monitoring system is malfunctioning.</p> <div data-bbox="495 332 1648 484" style="border: 1px solid gray; padding: 5px;"> <p><b>⚠ WARNING</b> There is a risk of an accident if the tire pressure monitoring system is malfunctioning</p> <p>The tire pressure monitoring system cannot issue a warning if there is pressure loss in one or more of the tires. Tires with insufficient tire pressure may impair the driving characteristics as well as steering and braking.</p> <p>► Have the tire pressure monitoring system checked at a qualified specialist workshop.</p> </div>
<p>Tire Pressure Monitor Inoperative Tire Pressure Sensors Missing</p>	<p>* The wheels installed do not have suitable tire pressure sensors. The tire pressure monitoring system is deactivated.</p> <p>► Install wheels with suitable tire pressure sensors.</p>
<div data-bbox="155 601 312 684" style="border: 1px solid black; text-align: center; width: 85px; height: 80px; margin-bottom: 5px;">  </div> <p>Wheel Sensor(s) Missing</p>	<p>* There is no signal from the tire pressure sensor in at least one wheel. No pressure value is displayed for the affected tire.</p> <p>► Have the faulty tire pressure sensor replaced at a qualified specialist workshop.</p>
<div data-bbox="155 743 312 826" style="border: 1px solid black; text-align: center; width: 85px; height: 80px; margin-bottom: 5px;">  </div> <p>Check Tires</p>	<p>* The tire pressure in one or more tires has dropped significantly. The wheel position is displayed. A warning tone will also sound.</p>

Display messages	Possible causes/consequences and ► Solutions
	<p><b>▲ WARNING</b> Risk of an accident due to insufficient tire pressure</p> <ul style="list-style-type: none"> <li>• The tires can burst.</li> <li>• The tires can wear excessively and/or unevenly.</li> <li>• The driving characteristics as well as the steering and braking may be greatly impaired.</li> </ul> <p>You could then lose control of the vehicle.</p> <ul style="list-style-type: none"> <li>► Observe the recommended tire pressures.</li> <li>► Adjust the tire pressure if necessary.</li> </ul> <p>► Stop the vehicle in accordance with the traffic conditions.</p> <p>► Check the tire pressure (→ page 315) and the tires.</p>
 <p>Please Correct Tire Pressure</p>	<p>* The tire pressure is too low in at least one of the tires, or the difference in tire pressure between the individual wheels is too great.</p> <ul style="list-style-type: none"> <li>► Check the tire pressure and add air, if necessary.</li> <li>► When the tire pressure is correct, restart the tire pressure monitor (→ page 320).</li> </ul>

Display messages	Possible causes/consequences and ► Solutions
 <p data-bbox="144 339 399 365">Warning Tire Malfunction</p>	<p data-bbox="476 249 1356 275">* The pressure in one or more tires has dropped suddenly. The wheel position is displayed.</p> <div data-bbox="500 291 1644 332"><p data-bbox="506 298 1108 324">▲ <b>WARNING</b> Risk of an accident from driving with a flat tire</p></div> <ul data-bbox="513 339 1541 399" style="list-style-type: none"><li data-bbox="513 339 938 365">• The tires can overheat and be damaged.</li><li data-bbox="513 370 1541 399">• The driving characteristics as well as the steering and braking characteristics may be greatly impaired.</li></ul> <p data-bbox="513 415 920 441">You could then lose control of the vehicle.</p> <ul data-bbox="513 451 1600 570" style="list-style-type: none"><li data-bbox="513 451 814 477">► Do not drive with a flat tire.</li><li data-bbox="513 482 1600 534">► Do not exceed the maximum permissible driving distance in emergency mode and the maximum permissible speed with a flat MOExtended tire.</li><li data-bbox="513 539 851 570">► Observe the notes on flat tires.</li></ul> <p data-bbox="495 596 820 622">Notes on flat tires (→ page 293).</p> <ul data-bbox="495 632 1092 689" style="list-style-type: none"><li data-bbox="495 632 1092 658">► Stop the vehicle in accordance with the traffic conditions.</li><li data-bbox="495 664 685 689">► Check the tires.</li></ul>
 <p data-bbox="144 798 316 824">Tires Overheated</p>	<p data-bbox="476 708 1609 760">* At least one tire is overheating. The affected tires are displayed in red. At temperatures close to the limit value, the tires are displayed in yellow.</p> <div data-bbox="500 775 1644 817"><p data-bbox="506 783 1179 809">▲ <b>WARNING</b> Risk of an accident from driving with overheated tires</p></div> <p data-bbox="513 824 778 850">Overheated tires can burst.</p>





Display messages	Possible causes/consequences and ► Solutions
 <p data-bbox="195 399 343 422">Reduce Speed</p>	<p data-bbox="561 256 1696 288">► Reduce speed so that the tires cool down.</p> <p data-bbox="528 308 1659 360">* At least one tire is overheating. The affected tires are displayed in red. At temperatures close to the limit value, the tires are displayed in yellow.</p> <p data-bbox="556 381 1696 412"><b>▲ WARNING</b> Risk of an accident from driving with overheated tires</p> <p data-bbox="565 425 827 446">Overheated tires can burst.</p> <p data-bbox="561 459 1696 491">► Reduce speed so that the tires cool down.</p>



### Tire pressure loss warning system

Display messages	Possible causes/consequences and ► Solutions
<p data-bbox="195 640 449 684">Check Tire and Tire Pressure</p>	<p data-bbox="528 640 1332 695">* Canada only: The tire pressure loss warning system has detected a significant loss of pressure.</p> <p data-bbox="556 715 1696 746"><b>▲ WARNING</b> Risk of an accident due to insufficient tire pressure</p> <ul data-bbox="569 764 1443 850" style="list-style-type: none"> <li>• The tires can burst.</li> <li>• The tires can wear excessively and/or unevenly.</li> <li>• The driving characteristics as well as the steering and braking may be greatly impaired.</li> </ul>

Display messages	Possible causes/consequences and ► Solutions
	<p>You could then lose control of the vehicle.</p> <ul style="list-style-type: none"> <li>► Observe the recommended tire pressures.</li> <li>► Adjust the tire pressure if necessary.</li> </ul> <ul style="list-style-type: none"> <li>► Stop the vehicle in accordance with the traffic conditions.</li> <li>► Check the tire pressure (→ page 315) and the tires.</li> <li>► When the tire pressure is correct, restart the tire pressure loss warning system (→ page 321).</li> </ul>
<p>Check Tire Pressure Then Restart Run Flat Indicator</p>	<p>* Canada only: The tire pressure loss warning system generated a display message and has not been restarted since.</p> <ul style="list-style-type: none"> <li>► When the tire pressure is correct, restart the tire pressure loss warning system (→ page 321).</li> </ul>
<p>Run Flat Indicator Inoperative</p>	<p>* Canada only: The tire pressure loss warning system is malfunctioning.</p> <ul style="list-style-type: none"> <li>► Consult a qualified specialist workshop.</li> </ul>

## Engine oil

Display messages	Possible causes/consequences and ► Solutions
 <p data-bbox="195 384 458 459">Check Engine Oil Level At Next Refueling (Add 1 Quart)</p>	<p data-bbox="526 291 1073 314">* The engine oil level has dropped to the minimum level.</p> <div data-bbox="550 335 1696 418" style="border: 1px solid gray; padding: 5px;"> <p data-bbox="559 342 1251 366">! <b>NOTE</b> Engine damage caused by driving with insufficient engine oil</p> <p data-bbox="559 384 1055 408">► Avoid long journeys with insufficient engine oil.</p> </div> <p data-bbox="541 436 1243 459">► When next refueling, add 1.1 US qt (1 l) of engine oil (→ page 278).</p> <p data-bbox="541 477 888 501">Notes on engine oil (→ page 353).</p>
 <p data-bbox="195 612 469 664">Engine Oil Level Reduce Oil Level</p>	<p data-bbox="526 519 844 542">* The engine oil level is too high.</p> <div data-bbox="550 563 1696 646" style="border: 1px solid gray; padding: 5px;"> <p data-bbox="559 570 1210 594">! <b>NOTE</b> Engine damage caused by driving with excess engine oil</p> <p data-bbox="559 612 1014 636">► Avoid long journeys with excess engine oil.</p> </div> <p data-bbox="541 664 1456 687">► Consult a qualified specialist workshop immediately and have the engine oil level reduced.</p>
 <p data-bbox="195 798 412 850">Engine Oil Level Stop Switch Off Vehicle</p>	<p data-bbox="526 705 837 729">* The engine oil level is too low.</p> <div data-bbox="550 750 1696 832" style="border: 1px solid gray; padding: 5px;"> <p data-bbox="559 757 1251 781">! <b>NOTE</b> Engine damage caused by driving with insufficient engine oil</p> <p data-bbox="559 798 1055 822">► Avoid long journeys with insufficient engine oil.</p> </div> <p data-bbox="541 850 1506 874">► Stop the vehicle immediately in accordance with the traffic conditions. Do not continue driving.</p>

Display messages	Possible causes/consequences and ► Solutions
	<ul style="list-style-type: none"> <li>► Switch off the vehicle.</li> <li>► Add 1.1 US qt (1 l) of engine oil (→ page 278).</li> <li>► Check the engine oil level.</li> </ul> <p>Notes on engine oil (→ page 353).</p>
 <p>Engine Oil Pressure Stop Switch Off Vehicle</p>	<p>* The oil pressure is too low.</p> <div style="border: 1px solid gray; padding: 5px; margin: 5px 0;"> <p><b>!</b> <b>NOTE</b> Engine damage caused by driving with insufficient oil pressure</p> <p>► Avoid driving with insufficient oil pressure.</p> </div> <ul style="list-style-type: none"> <li>► Stop the vehicle immediately in accordance with the traffic conditions. Do not continue driving.</li> <li>► Switch off the vehicle.</li> <li>► Consult a qualified specialist workshop.</li> </ul>
 <p>Engine Oil Level Cannot Be Measured</p>	<p>* The electrical connection to the oil level sensor has been interrupted or the oil level sensor is faulty.</p> <ul style="list-style-type: none"> <li>► Consult a qualified specialist workshop.</li> </ul>

## Warning and indicator lamps

### Overview of indicator and warning lamps

Some systems will perform a self-test when the vehicle is switched on. Some indicator and warning lamps may briefly light up or flash. This behaviour is non-critical. These indicator and warning lamps indicate a malfunction only if they light up or flash after the vehicle has been started or during a journey.

### Standard driver's display





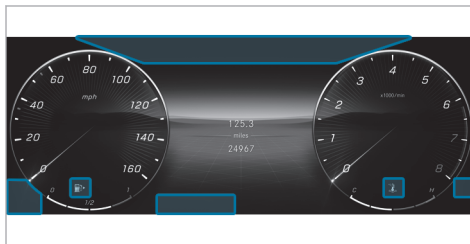

### Widescreen cockpit driver's display



### Indicator and warning lamps



#### Occupant safety

-  Restraint system (→ page 413)
-  Seat belt (→ page 413)
-  Occupant presence reminder (white) (→ page 413)
-  Occupant presence reminder (yellow) (→ page 413)





#### Drive system

-  Reduced power (→ page 415)



#### Vehicle

-  Power steering (yellow) (→ page 415)
-  Power steering (red) (→ page 415)

#### Engine

-  Vehicles with a widescreen cockpit: coolant temperature (→ page 416)
-  Engine diagnostics (→ page 416)
-  Vehicles with a gasoline engine: engine operating temperature (→ page 416)
-  Electrical malfunction (→ page 416)
-  Reserve fuel with fuel filler flap location indicator (→ page 416)

#### Braking

-  Electric parking brake (yellow) (→ page 420)
-  USA: electric parking brake (red) (→ page 420)
-  Canada: electric parking brake (red) (→ page 420)

## 412 Display messages and warning/indicator lamps

---

 USA: Recuperative Brake System  
(→ page 420)

 Canada: brakes (yellow)(→ page 420)

 USA: brakes (red) (→ page 420)

 Canada: brakes (red) (→ page 420)

### Driving and driving safety systems

 ABS (→ page 423)

 ESP® (→ page 423)

 ESP® OFF (→ page 423)

 ATTENTION ASSIST (→ page 423)

 Traffic Sign Assist (→ page 423)

 Distance warning (→ page 423)

 Active Brake Assist (→ page 423)

 Active Brake Assist (→ page 423)

### Mercedes-Benz emergency call system

 Mercedes-Benz emergency call system  
(→ page 426)

### Tire pressure monitoring system

 Tire pressure monitoring system  
(→ page 427)

### Exterior lighting

 Side lights (→ page 120)

 Low beam (→ page 120)

 High-beam headlamps (→ page 121)

 Turn signal lights (→ page 121)

 Rear fog light (→ page 120)



### Symbols on the central display

 Drive Away Assist (→ page 217)



 Cross Traffic Alert (→ page 218)

 Maneuvering brake function (→ page 218)

## Occupant safety

Warning/indicator lamp	Possible causes/consequences and ► Solutions
 <p data-bbox="195 388 443 435">Restraint system warning lamp</p>	<p data-bbox="513 295 1173 341">* The restraint system red warning lamp is lit while the vehicle is on. The restraint system is malfunctioning (→ page 39).</p> <div data-bbox="532 357 1690 476" style="border: 1px solid gray; padding: 5px;"> <p data-bbox="541 367 1247 398"><b>▲ WARNING</b> Risk of injury due to malfunctions in the restraint system</p> <p data-bbox="547 409 1617 435">Components in the restraint system may be activated unintentionally or not deploy as planned in an accident.</p> <p data-bbox="547 440 1506 471">► Have the restraint system checked and repaired immediately at a qualified specialist workshop.</p> </div> <ul data-bbox="526 492 1071 590" style="list-style-type: none"> <li data-bbox="526 492 739 523">► Drive on carefully.</li> <li data-bbox="526 528 979 559">► Note the messages on the driver's display.</li> <li data-bbox="526 564 1071 590">► Consult a qualified specialist workshop immediately.</li> </ul>
 <p data-bbox="195 699 425 745">Seat belt warning lamp flashes</p>	<p data-bbox="513 606 1441 657">* The red seat belt warning lamp flashes and an intermittent warning tone sounds. The driver or front passenger has not fastened his/her seat belt while the vehicle is in motion.</p> <ul data-bbox="526 663 1062 751" style="list-style-type: none"> <li data-bbox="526 663 914 694">► Fasten your seat belt (→ page 39).</li> <li data-bbox="526 694 979 720">There are objects on the front passenger seat.</li> <li data-bbox="526 725 1062 751">► Remove the objects from the front passenger seat.</li> </ul>

#### 414 Display messages and warning/indicator lamps



Warning/indicator lamp	Possible causes/consequences and ► Solutions
 <p data-bbox="144 342 371 394">Seat belt warning lamp lights up</p>	<p data-bbox="463 249 1308 272">* The red seat belt warning lamp lights up for six seconds once the vehicle has started.</p> <p data-bbox="476 283 986 306">In addition, an intermittent warning tone may sound.</p> <p data-bbox="476 311 1411 334">The red seat belt warning lamp reminds the driver and front passenger to fasten their seat belts.</p> <p data-bbox="476 344 857 367">► Fasten your seat belt (→ page 39).</p> <p data-bbox="476 386 1463 409">If you have placed objects on the front passenger seat, the red seat belt warning lamp may remain lit.</p>
 <p data-bbox="144 521 371 596">Occupant presence reminder warning lamp (white)</p>	<p data-bbox="463 430 1045 453">* The white occupant presence reminder warning lamp is lit.</p> <p data-bbox="476 458 946 481">The occupant presence reminder is deactivated.</p> <p data-bbox="476 492 1116 514">► Switch on the occupant presence reminder, see (→ page 68).</p>
 <p data-bbox="144 707 417 783">Occupant presence reminder warning lamp (yellow)</p>	<p data-bbox="463 615 1055 638">* The yellow occupant presence reminder warning lamp is lit.</p> <p data-bbox="476 643 972 666">The occupant presence reminder is malfunctioning</p> <p data-bbox="476 676 925 699">► Note the messages on the driver's display.</p>



## Drive system

Warning/indicator lamp	Possible causes/consequences and ► Solutions
 <p data-bbox="194 383 425 429">Reduced warning lamp power</p>	<p data-bbox="508 290 979 341">* The yellow reduced-power warning lamp is on. Drive system power output is reduced.</p> <p data-bbox="526 352 979 378">► Note the messages on the driver's display.</p>

## Vehicle



Warning/indicator lamp	Possible causes/consequences and ► Solutions
 <p data-bbox="194 673 425 725">Power steering warning lamp (yellow)</p>	<p data-bbox="508 580 1238 631">* The yellow power steering warning lamp is lit while the vehicle is running. The power assistance or the steering itself is malfunctioning.</p> <p data-bbox="526 642 979 668">► Note the messages on the driver's display.</p>
 <p data-bbox="194 833 425 880">Power steering warning lamp (red)</p>	<p data-bbox="508 740 1210 792">* The red power steering warning lamp is lit while the vehicle is running. The power assistance or the steering itself is malfunctioning.</p>



Warning/indicator lamp	Possible causes/consequences and ► Solutions
	<p data-bbox="482 249 1652 288"><b>▲ WARNING</b> Risk of accident if steering capability is impaired</p> <p data-bbox="482 291 1652 329">If the steering does not function as intended, the vehicle's operating safety is jeopardized.</p> <ul data-bbox="482 332 1652 422" style="list-style-type: none"><li data-bbox="482 332 1652 381">► Pull over and stop the vehicle safely as soon as possible, paying attention to road and traffic conditions. Do not continue driving under any circumstances.</li><li data-bbox="482 384 1652 422">► Consult a qualified specialist workshop.</li></ul> <p data-bbox="482 436 1652 473">► Note the messages on the driver's display.</p>

## Engine



Warning/indicator lamp	Possible causes/consequences and ► Solutions
 <p data-bbox="144 705 413 733">Coolant warning lamp (red)</p>	<p data-bbox="458 615 1086 643">* The red coolant warning lamp is lit while the engine is running.</p> <p data-bbox="458 646 680 674">Possible causes are:</p> <ul data-bbox="482 677 931 848" style="list-style-type: none"><li data-bbox="482 677 931 705">• The temperature sensor is malfunctioning</li><li data-bbox="482 708 931 736">• The coolant level is too low</li><li data-bbox="482 739 931 767">• The air supply to the radiator is obstructed</li><li data-bbox="482 770 931 798">• The radiator fan is faulty</li><li data-bbox="482 801 931 848">• The engine coolant pump is faulty</li></ul>





Warning/indicator lamp	Possible causes/consequences and ► Solutions
	<p>If there is an additional warning tone, the coolant temperature has exceeded the maximum permissible temperature.</p> <p><b>▲ WARNING</b> Risk of burns when opening the hood</p> <p>If you open the hood in the event of an overheated engine or fire in the engine compartment, the following situations may occur:</p> <ul style="list-style-type: none"> <li>• You may come into contact with hot gases.</li> <li>• You may come into contact with other escaping hot operating fluids.</li> </ul> <ul style="list-style-type: none"> <li>► Before opening the hood, allow the engine to cool down.</li> <li>► In the event of a fire in the engine compartment, keep the hood closed and call the fire service.</li> </ul> <ul style="list-style-type: none"> <li>► Stop immediately in accordance with the traffic conditions and switch off the vehicle. Do not continue driving.</li> <li>► Note the messages on the driver's display.</li> </ul> <p><b>If the coolant temperature display is at the lower end of the temperature scale:</b></p> <ul style="list-style-type: none"> <li>► Consult a qualified specialist workshop.</li> </ul> <p><b>If the coolant temperature display is at the upper end of the temperature scale:</b></p> <ul style="list-style-type: none"> <li>► Exit the vehicle and keep a safe distance from it until the engine has cooled down.</li> <li>► Check the coolant level (→ page 279).</li> <li>► Make sure that the air supply to the radiator is not obstructed.</li> </ul>

Warning/indicator lamp	Possible causes/consequences and ► Solutions
 <p data-bbox="144 410 408 459">Coolant warning lamp (yellow)</p>	<p data-bbox="476 249 1609 301">► Avoiding high loads on the engine, drive to the nearest qualified specialist workshop. In doing so, ensure that the coolant temperature display remains below the red area.</p> <p data-bbox="463 317 1110 342">* The yellow coolant warning lamp is lit while the engine is running.</p> <p data-bbox="476 353 676 373">Possible causes are:</p> <ul data-bbox="486 389 1073 477" style="list-style-type: none"> <li data-bbox="486 389 916 410">• The temperature sensor is malfunctioning</li> <li data-bbox="486 420 1073 441">• The charge air, transmission oil or battery cooling is faulty</li> <li data-bbox="486 451 953 472">• The radiator shutters are blocked or defective</li> </ul> <p data-bbox="476 498 1332 519">► Avoiding high loads on the engine, drive to the nearest qualified specialist workshop.</p>
 <p data-bbox="144 632 417 653">Check Engine warning lamp</p>	<p data-bbox="463 539 1175 560">* The yellow Check Engine warning lamp is lit while the engine is running.</p> <p data-bbox="476 565 1267 586">A malfunction has occurred in the engine, the exhaust system or the fuel system.</p> <p data-bbox="476 596 1581 617">The emissions limit value may have been exceeded and the engine may be running in emergency operation mode.</p> <p data-bbox="476 627 1628 679">In some states, legal requirements stipulate that you must immediately consult a qualified specialist workshop as soon as the yellow Check Engine warning lamp lights up.</p> <p data-bbox="476 695 1286 715">► Have the vehicle checked as soon as possible at a qualified specialist workshop.</p>
 <p data-bbox="144 829 417 871">Electrical malfunction warning lamp</p>	<p data-bbox="463 733 953 785">* The red electrical malfunction warning lamp is lit. There is a malfunction in the electrics.</p> <p data-bbox="476 798 925 819">► Note the messages on the driver's display.</p>

Warning/indicator lamp	Possible causes/consequences and ► Solutions
 <p data-bbox="194 341 462 393">Engine operating temperature warning lamp</p>	<p data-bbox="508 248 1589 300">* <b>Vehicles with a gasoline engine:</b> after a cold start, the blue engine operating temperature warning lamp is on. Engine output and engine torque are reduced.</p> <ul style="list-style-type: none"> <li data-bbox="526 305 1034 336">► Take this into consideration in your driving style.</li> </ul>
 <p data-bbox="194 502 462 554">Fuel reserve warning lamp flashes</p>	<p data-bbox="508 409 1681 461">* The yellow fuel reserve warning lamp lights up while you are driving. There has been pressure loss in the fuel system. The fuel filler cap is not closed correctly or the fuel system is leaking.</p> <ul style="list-style-type: none"> <li data-bbox="526 466 794 497">► Close the fuel filler cap.</li> </ul> <p data-bbox="526 518 1053 549">If the fuel filler cap has already been closed correctly:</p> <ul style="list-style-type: none"> <li data-bbox="526 554 951 585">► Consult a qualified specialist workshop.</li> </ul>
 <p data-bbox="194 688 462 740">Fuel reserve warning lamp lights up</p>	<p data-bbox="508 595 1256 647">* The yellow fuel reserve warning lamp lights up while the engine is running. The fuel supply has dropped into the reserve range.</p> <ul style="list-style-type: none"> <li data-bbox="526 652 637 683">► Refuel.</li> </ul>

## Brakes



Warning/indicator lamp	Possible causes/consequences and ► Solutions
<p data-bbox="155 294 310 377"></p> <p data-bbox="144 384 413 436">Electric parking brake indicator lamp (red) (USA only)</p> <p data-bbox="155 441 310 524"></p> <p data-bbox="144 531 413 609">Electric parking brake indicator lamp (red) (Canada only)</p> <p data-bbox="155 614 310 697"></p> <p data-bbox="144 704 413 752">Electric parking brake indicator lamp (yellow)</p>	<p data-bbox="463 294 1068 317">* The red electric parking brake indicator lamp flashes or is lit.</p> <p data-bbox="476 327 1326 350">The yellow electric parking brake indicator lamp is also lit in the event of a malfunction.</p> <p data-bbox="476 355 925 378">► Note the messages on the driver's display.</p>



Warning/indicator lamp	Possible causes/consequences and ► Solutions
 <p>RBS warning lamp (USA only)</p>  <p>Brakes warning lamp (yellow) (Canada only)</p>	<p>*The yellow  warning lamp (USA only) or the yellow  brake warning lamp (Canada only) is lit while the vehicle is running.</p> <p><b>▲ WARNING</b> Risk of an accident due to a brake system malfunction</p> <p>If the brake system is malfunctioning, braking characteristics may be impaired.</p> <ul style="list-style-type: none"><li>▶ Drive on carefully.</li><li>▶ Have the brake system checked immediately at a qualified specialist workshop.</li></ul> <p>► Adjust your speed and drive on carefully, leaving a suitable distance to the vehicle in front.</p> <p>► If the driver's display shows a display message, observe it.</p> <p>► Consult a qualified specialist workshop.</p>



Warning/indicator lamp	Possible causes/consequences and ► Solutions
<div data-bbox="155 252 310 332" data-label="Image"> </div> <p data-bbox="144 342 408 391">Brakes warning lamp (USA only)</p> <div data-bbox="155 397 310 477" data-label="Image"> </div> <p data-bbox="144 487 408 536">Brakes warning lamp (Canada only)</p>	<p data-bbox="458 249 1068 273">* The red brake warning lamp is lit while the vehicle is running.</p> <p data-bbox="476 283 680 307">Possible causes are:</p> <ul data-bbox="482 318 1406 377" style="list-style-type: none"> <li data-bbox="482 318 1406 341">• The brake force boosting is malfunctioning and the braking characteristics may be affected.</li> <li data-bbox="482 352 1073 377">• There is insufficient brake fluid in the brake fluid reservoir.</li> </ul> <p data-bbox="476 394 925 418">► Note the messages on the driver's display.</p> <div data-bbox="482 439 1644 477" data-label="Section-Header"> <p><b>▲ WARNING</b> Risk of accident and injury if brake force boosting is malfunctioning</p> </div> <p data-bbox="495 487 1591 536">If brake force boosting is malfunctioning, increased brake pedal force may be necessary for braking. The braking characteristics may be impaired. The braking distance can increase in emergency braking situations.</p> <ul data-bbox="495 547 1116 606" style="list-style-type: none"> <li data-bbox="495 547 1116 570">► Stop in a safe location immediately. Do not continue driving.</li> <li data-bbox="495 581 916 606">► Consult a qualified specialist workshop.</li> </ul> <div data-bbox="482 636 1644 674" data-label="Section-Header"> <p><b>▲ WARNING</b> Risk of an accident due to low brake fluid level</p> </div> <p data-bbox="495 684 1467 708">If the brake fluid level is too low, the braking effect and the braking characteristics may be impaired.</p> <ul data-bbox="495 718 1609 836" style="list-style-type: none"> <li data-bbox="495 718 1609 767">► Pull over and stop the vehicle safely as soon as possible, paying attention to road and traffic conditions. Do not continue driving under any circumstances.</li> <li data-bbox="495 778 916 801">► Consult a qualified specialist workshop.</li> <li data-bbox="495 812 753 836">► Do not add brake fluid.</li> </ul>





## Driving and driving safety systems

Warning/indicator lamp	Possible causes/consequences and ► Solutions
 <p data-bbox="194 383 378 409">ABS warning lamp</p>	<p data-bbox="508 290 1136 341">* The yellow ABS warning lamp is lit while the vehicle is running. ABS is malfunctioning.</p> <p data-bbox="526 352 1118 378">If an additional warning tone sounds, EBD is malfunctioning.</p> <p data-bbox="526 388 1284 414">Other driving systems and driving safety systems may also be malfunctioning.</p> <ul style="list-style-type: none"> <li data-bbox="526 419 979 445">► Note the messages on the driver's display.</li> </ul> <div style="border: 1px solid gray; padding: 5px; margin-top: 10px;"> <p data-bbox="535 471 1256 497"><b>⚠ WARNING</b> There is a risk of skidding if EBD or ABS is malfunctioning</p> <p data-bbox="545 512 905 538">The wheels may lock during braking.</p> <p data-bbox="545 549 1672 595">The steerability and braking characteristics are heavily impaired and the braking distance may increase. In addition, other driving safety systems are switched off.</p> <ul style="list-style-type: none"> <li data-bbox="545 606 757 631">► Drive on carefully.</li> <li data-bbox="545 642 1349 668">► Have the brake system checked immediately at a qualified specialist workshop.</li> </ul> </div>
 <p data-bbox="194 782 462 808">ESP® warning lamp flashes</p>	<p data-bbox="508 694 1191 745">* The yellow ESP® warning lamp flashes while the vehicle is in motion. One or more wheels have reached their grip limit (→ page 170).</p> <ul style="list-style-type: none"> <li data-bbox="526 756 1191 782">► Adapt your driving style to suit the road and weather conditions.</li> </ul>

Warning/indicator lamp	Possible causes/consequences and ► Solutions
 <p>ESP® warning lamp lights up</p>	<p>* The yellow ESP® warning lamp is lit while the vehicle is running. ESP® is malfunctioning. Other driving systems and driving safety systems (e.g. BAS) may also be malfunctioning.</p> <p>► Note the messages on the driver's display.</p> <p><b>▲ WARNING</b> Risk of skidding if ESP® is malfunctioning</p> <p>If ESP® is malfunctioning, ESP® cannot carry out vehicle stabilization. In addition, other driving safety systems are switched off.</p> <ul style="list-style-type: none"> <li>► Drive on carefully.</li> <li>► Have ESP® checked at a qualified specialist workshop.</li> </ul>
 <p>ESP® OFF warning lamp</p>	<p>* The yellow ESP® OFF warning lamp is lit while the vehicle is running. ESP® is deactivated. Other driving systems and driving safety systems may also be inoperative.</p> <p><b>▲ WARNING</b> Risk of skidding when driving with ESP® deactivated</p> <p>ESP® does not act to stabilize the vehicle. The availability of further driving safety systems is also limited.</p> <ul style="list-style-type: none"> <li>► Drive on carefully.</li> <li>► Deactivate ESP® only for as long as the situation requires.</li> </ul>



Warning/indicator lamp	Possible causes/consequences and ► Solutions
	<p>If ESP® cannot be activated, ESP® is malfunctioning.</p> <ul style="list-style-type: none"> <li>► Have ESP® checked immediately at a qualified specialist workshop.</li> </ul> <p>► Observe the notes on deactivating ESP® (→ page 170).</p>
 <p>ATTENTION ASSIST warning lamp</p>	<p>* The ATTENTION ASSIST warning lamp is lit. ATTENTION ASSIST is malfunctioning.</p> <ul style="list-style-type: none"> <li>► Consult a qualified specialist workshop.</li> </ul>
 <p>Traffic Sign Assist warning lamp</p>	<p>* The Traffic Sign Assist warning lamp is lit. Traffic Sign Assist is malfunctioning.</p> <ul style="list-style-type: none"> <li>► Note the messages on the driver's display.</li> </ul>
 <p>Distance warning lamp</p>	<p>* The red distance warning lamp lights up while the vehicle is in motion. The distance to the vehicle in front is too small for the speed selected.</p> <p>If there is an additional warning tone, you are approaching an obstacle at too high a speed.</p> <ul style="list-style-type: none"> <li>► Be prepared to brake immediately.</li> <li>► Increase the distance.</li> </ul>

Warning/indicator lamp	Possible causes/consequences and ► Solutions
 <p data-bbox="144 384 417 433">Active Brake Assist warning lamp</p>	<p data-bbox="476 249 931 275">Function of Active Brake Assist (→ page 188).</p> <p data-bbox="463 291 1480 339">* The Active Brake Assist warning lamp is on. Due to dirty sensors or a malfunction, the system is not available or the range of functions is restricted.</p> <ul style="list-style-type: none"> <li data-bbox="476 353 925 379">► Note the messages on the driver's display.</li> </ul>
 <p data-bbox="144 544 417 593">Active Brake Assist warning lamp</p>	<p data-bbox="463 451 1313 534">* The Active Brake Assist warning lamp is on. The system is switched off or the range of functions has been automatically restricted. This may be the case if another driving system has been activated.</p> <ul style="list-style-type: none"> <li data-bbox="476 544 1064 570">► Observe the notes on Active Brake Assist (→ page 188).</li> </ul>

### Mercedes-Benz emergency call system

Warning/indicator lamp	Possible causes/consequences and ► Solutions
 <p data-bbox="144 835 417 883">Mercedes-Benz emergency call system warning lamp</p>	<p data-bbox="463 741 1641 767">*The Mercedes-Benz emergency call system is malfunctioning. The Mercedes me connect system is also malfunctioning.</p> <ul style="list-style-type: none"> <li data-bbox="476 767 898 793">► Consult a qualified specialist workshop.</li> </ul>

## Tire pressure monitor

Warning/indicator lamp	Possible causes/consequences and ► Solutions
 <p data-bbox="195 410 482 459">Tire pressure monitoring system warning lamp flashes</p>	<p data-bbox="519 314 1665 394">*The yellow tire pressure monitor warning lamp (pressure loss/malfunction) flashes for approximately one minute and then remains lit. The tire pressure monitoring system is malfunctioning.</p> <div data-bbox="532 412 1696 562" style="border: 1px solid gray; padding: 5px;"> <p data-bbox="541 418 1517 446"><b>▲ WARNING</b> There is a risk of an accident if the tire pressure monitoring system is malfunctioning</p> <p data-bbox="547 458 1624 519">The tire pressure monitoring system cannot issue a warning if there is pressure loss in one or more of the tires. Tires with insufficient tire pressure may impair the driving characteristics as well as steering and braking.</p> <p data-bbox="547 526 1406 554">► Have the tire pressure monitoring system checked at a qualified specialist workshop.</p> </div>
 <p data-bbox="195 673 463 749">Tire pressure monitoring system warning lamp lights up</p>	<p data-bbox="519 578 1446 627">*The yellow tire pressure monitoring system warning lamp (pressure loss/malfunction) is lit. The tire pressure monitoring system has detected tire pressure loss in at least one of the tires.</p> <div data-bbox="532 645 1696 870" style="border: 1px solid gray; padding: 5px;"> <p data-bbox="541 655 1190 683"><b>▲ WARNING</b> Risk of an accident due to insufficient tire pressure</p> <ul data-bbox="550 695 1424 790" style="list-style-type: none"> <li data-bbox="550 695 772 723">• The tires can burst.</li> <li data-bbox="550 729 1049 757">• The tires can wear excessively and/or unevenly.</li> <li data-bbox="550 763 1424 790">• The driving characteristics as well as the steering and braking may be greatly impaired.</li> </ul> <p data-bbox="547 806 957 833">You could then lose control of the vehicle.</p> <p data-bbox="547 840 994 868">► Observe the recommended tire pressures.</p> </div>

## 428 Display messages and warning/indicator lamps

---

Warning/indicator lamp	Possible causes/consequences and ► Solutions
	<ul style="list-style-type: none"><li data-bbox="482 253 1659 291">▶ Adjust the tire pressure if necessary.</li><li data-bbox="482 308 1659 335">▶ Stop the vehicle in accordance with the traffic conditions.</li><li data-bbox="482 342 1659 369">▶ Check the tire pressure and the tires.</li></ul>

## 1, 2, 3 ...

(SmartKey) battery.....	71
4MATIC.....	156
<b>48 V on-board electrical system</b>	
Displays in the driver's display.....	224
Operating safety.....	23

## A

<b>A/C function</b>	
Activating/deactivating (MBUX).....	133
Activating/deactivating (operating unit).....	133
<b>ABS</b> .....	169
<b>Acceleration</b>	
Kickdown.....	155
<b>Accident, emergency call</b> .....	263
<b>Activating/deactivating the acoustic locking verification signal</b> .....	70
<b>Active Brake Assist</b>	
Function.....	188
Setting.....	192

<b>Active Distance Assist DISTRONIC</b>	
Activating/deactivating.....	180
Active Emergency Stop Assist.....	187
Active Speed Limit Assist.....	182
Calling up a speed.....	180
Function.....	178
Increasing/decreasing the speed.....	180
Route-based speed adaptation.....	183
Storing a speed.....	180
<b>Active Emergency Stop Assist</b> .....	187
<b>Active headlamps</b> .....	123
<b>Active Lane Keeping Assist</b>	
Activating/deactivating.....	200
Function.....	198
Setting the sensitivity.....	201
<b>Active light function</b> .....	123
<b>Active Parking Assist</b>	
Automatic braking function.....	217
Exiting a parking space.....	215
Function.....	212
Maneuvering brake function.....	218
Parking.....	214
Pausing.....	216
<b>Active Service System PLUS</b> .....	273

<b>Active Speed Limit Assist</b> .....	182
<b>Active Steering Assist</b>	
Activating/deactivating.....	186
Active Emergency Stop Assist.....	187
Function.....	185
<b>Adaptive cruise control</b> .....	183
<b>Adaptive damping system</b>	
Suspension.....	201
<b>Adaptive Highbeam Assist</b>	
Activating/deactivating.....	124
<b>Additives</b>	
Engine oil.....	353
Fuel.....	352
<b>After-sales service</b> .....	273
<b>Air bag</b>	
Front air bag.....	52
Inflating.....	46
Overview.....	52
PASSENGER AIR BAG indicator lamp.....	41
Warning lamp.....	39
<b>Air conditioning menu</b>	
Air distribution.....	133
Climate control.....	133

- Air distribution**  
 Adjusting..... 133  
 Setting..... 132
- Air inlet**..... 281
- Air pressure**..... 315
- Air vents**  
 Adjusting..... 135
- Air/water duct**..... 281
- Airflow**  
 Setting..... 132
- Alarm system**..... 89
- All-wheel drive**..... 156
- Alternative route**..... 245
- Ambient lighting**..... 125
- Animals**..... 48
- Anti-lock braking system**..... 169
- Anti-theft alarm system**..... 89
- Anti-theft protection**  
 Immobilizer..... 89
- Apps, Mercedes me**  
 Mercedes me calls..... 255
- Mercedes me connect..... 258
- Assistance system**..... 168
- ASSYST PLUS**  
 Battery disconnection periods..... 274  
 Service interval display..... 273  
 Service requirements..... 273
- ATA**  
 Deactivating the alarm..... 90  
 Function..... 89  
 Interior protection..... 91  
 Interior protection function..... 90  
 Tow-away alarm function..... 90  
 Tow-away protection..... 90
- ATTENTION ASSIST**  
 Function..... 174  
 Setting..... 176
- Attention assistant**..... 174
- Authorized Mercedes-Benz Service Center**..... 27
- Authorized workshop**..... 27
- Automatic car wash**..... 282
- Automatic car wash mode**..... 283
- Automatic climate control**..... 133
- Automatic distance control**..... 178
- Automatic driving lights**..... 121
- Automatic emergency call**..... 263
- Automatic engine start/stop**..... 144
- Automatic front passenger air bag shutoff**  
 Function..... 43  
 Information (child restraint system on the front passenger seat)..... 57  
 PASSENGER AIR BAG indicator lamp..... 41
- Automatic measures after an accident**..... 45
- Automatic mirror folding function**..... 131
- Automatic seat adjustment**..... 100
- Automatic transmission**  
 DIRECT SELECT lever..... 150  
 Drive programs..... 148  
 DYNAMIC SELECT button..... 148  
 Engages neutral..... 152  
 Engaging drive position..... 153  
 Engaging reverse gear..... 151  
 Faulty gear shift..... 153  
 Kickdown..... 155  
 Manual gear shifting..... 153  
 Oil temperature (driver's display)..... 222





































































- Selecting park position..... 152
  - Steering wheel paddle shifters..... 153
  - Switching gears..... 150
  - Transmission position display..... 150
  - Transmission positions..... 150
  - Autonomous braking**..... 188
- B**
- BAS**..... 169
  - Basic information**..... 36
  - Battery (12 V battery)**
    - Charging..... 303
    - Notes..... 299
    - Notes (starting assistance and charging)..... 302
    - Replacing..... 305
    - Starting assistance..... 303
  - Battery (48 V)**
    - Notes..... 300
  - Battery (starter battery)**
    - charging, Remote Online..... 139
  - Belt**
    - Fastening..... 39
    - Notes on wearing correctly..... 38
  - Releasing..... 52
  - Blind Spot Assist**
    - Activating/deactivating..... 198
    - Function..... 197
  - Bluetooth®**
    - Connecting a mobile phone..... 254
  - Boost pressure, current (driver's display)**..... 222
  - Brake Assist**
    - Active Brake Assist..... 188
    - Brake Assist System..... 169
  - Brake Assist System**..... 169
  - Brake disks**..... 140
  - Brake fluid**..... 354
  - Brake force distribution**..... 171
  - Brake pads**..... 140
  - Brakepad gauge**..... 281
  - Brakes**
    - ABS (Anti-lock Braking System)..... 169
    - Active Brake Assist..... 188
    - BAS (Brake Assist System)..... 169
    - Checking the brakepad thickness..... 281
    - Driving tips..... 140
  - EBD (Electronic Brakeforce Distribution)..... 171
  - Electric parking brake..... 163
  - Handbrake..... 163
  - HOLD function..... 172
  - Limited braking effect (salt-treated roads)..... 140
  - New/replaced brake pads/brake discs.. 140
  - Notes on breaking in a new vehicle..... 140
  - Parking brake..... 163
  - Post-collision brake..... 45, 46
  - Braking assistance**
    - Active Brake Assist..... 188
    - Brake Assist System..... 169
  - Breakdown**
    - Assistance overview..... 16
    - Changing a wheel..... 338
    - Flat tire..... 293
    - Tow-starting..... 310
    - Towing methods..... 306
    - Transporting the vehicle..... 308
  - Breakdown (Roadside Assistance)**..... 22

- C**
- Calling the customer center for Mercedes-Benz**..... 256
- Calls**
- Mercedes me..... 255
  - Telephone menu..... 254
  - Using overhead control panel..... 255
- Camera**
- 360° camera..... 204
  - Button..... 208
  - Care..... 286
  - Cleaning..... 286
  - Function..... 204
  - Information..... 167
  - Opening the camera cover (rear view camera)..... 208
  - Rear view camera..... 201
  - Select view..... 208
- Car key**..... 69
- Car wash**
- Automatic car wash..... 282
  - Automatic car wash mode..... 283
  - Power washer..... 284
  - Washing by hand..... 284
- Car-to-X-Communication**
- Display on map..... 247
- Care**
- Air/water duct..... 281
  - Automatic car wash..... 282
  - Automatic car wash mode..... 283
  - Camera..... 286
  - Decorative foil..... 285
  - Display..... 287
  - Exterior lighting..... 286
  - Genuine wood/trim elements..... 287
  - Head-up display..... 287
  - Headliner..... 287
  - Paint..... 284
  - Plastic trim..... 287
  - Power washer..... 284
  - Seat belts..... 287
  - Steering wheel..... 287
  - Vehicle interior..... 287
  - Vehicle parts..... 286
  - Washing by hand..... 284
  - Wheels/rims..... 286
- Caring for plastic trim**..... 287
- Caring for rims**..... 286
- Central display**
- Operating..... 228
- Central locking system**
- Button..... 73
  - SmartKey..... 70
- Change of address**..... 23
- Change of ownership**..... 23
- Changing a wheel**
- Preparation..... 338
  - Raising the vehicle..... 339
- Charging**
- 12 V battery..... 303
  - USB port..... 110, 116
- Checking the brakepad thickness**..... 281
- Checking the coolant level**..... 279
- Child safety lock**
- Rear door..... 66
  - Side windows (rear passenger compartment)..... 67
- Child seat**
- Adjusting the vehicle seat..... 59
  - Basic instructions..... 53
  - Front passenger seat..... 57

- Installing ISOFIX..... 62
- Rearward-facing..... 59
- Risks/dangers..... 55
- Securing on the rear seat with the seat belt..... 65
- Securing to the front passenger seat with the seat belt..... 65
- The most important information in brief... 53
- Top Tether..... 63
- Children**
- Avoiding dangers in the vehicle..... 55
- Basic instructions..... 53
- Special seat belt retractor..... 61
- Chock**..... 337
- Clean varnish**..... 284
- Cleaning**
- Air/water duct..... 281
- Automatic car wash..... 282
- Automatic car wash mode..... 283
- Camera..... 286
- Decorative foil..... 285
- Genuine wood/trim elements..... 287
- Paint..... 284
- Power washer..... 284
- Sensors..... 286
- Vehicle interior..... 287
- Vehicle parts..... 286
- Washing by hand..... 284
- Cleaning carpets**..... 287
- Cleaning seat covers**..... 287
- Climate control, Air-conditioning system, Blower, Cooling**
- Activating/deactivating..... 132
- Activating/deactivating the A/C function (control panel)..... 133
- Activating/deactivating the A/C function (MBUX)..... 133
- Activating/deactivating the synchronization function (control panel)..... 134
- Air vents (front)..... 135
- Air vents (rear passenger compartment)..... 135
- Automatic control..... 133
- Control panel for 3-zone automatic climate control..... 132
- Control panel for dual-zone automatic climate control..... 132
- Defrosting the windshield..... 132
- Defrosting windows..... 134
- Filling capacity for refrigerant and PAG oil..... 356
- Notes..... 132
- Refrigerant..... 355
- Residual heat..... 134
- Setting the air distribution..... 132
- Setting the airflow..... 132
- Setting the vehicle interior temperature..... 132
- Switching air-recirculation mode on/off..... 134
- Switching the rear window heater on/off..... 132
- Synchronization function..... 134
- Ventilation with comfort opening..... 83
- COC papers, CERTIFICATE OF CONFORMITY**..... 346
- Cockpit**
- Instrument panel..... 6
- Coffee cup symbol**..... 174
- Collision detection (parked vehicle)**
- Setting..... 165, 166
- Combination switch**
- Lights..... 121

- Windshield wipers..... 126
- Commuter route**..... 245
- Components relevant to radio regulation**
- Declaration of conformity..... 25
- Control elements**..... 21
- Convenience closing feature**..... 84
- Convenience opening**..... 83
- Coolant**
- Capacity..... 355
- Notes..... 354
- Copyright**
- License..... 34
- Copyrights**
- Trademarks..... 34
- Cornering light function**..... 122
- Correct use**..... 27
- Cover**..... 85
- Cross traffic (warning)**..... 218
- Cross Traffic Alert, Cross traffic warning**..... 218
- Crosswind Assist**..... 171
- Cruise control**
- Activating/deactivating..... 176
- Calling up a speed..... 176
- Function..... 176
- Requirements..... 176
- Setting a speed..... 176
- Storing a speed..... 176
- Customer Assistance Center (CAC)**..... 28
- Customer Relations Department**..... 28
- D**
- Damage**
- Limited protection..... 48
- Dashcam**
- Notes..... 249
- Selecting a USB device..... 250
- Starting/stopping an individual recording..... 251
- Starting/stopping loop recording..... 250
- Data processing in the vehicle**..... 30
- Data protection rights**..... 33
- Data storage**
- Data protection rights..... 33
- Electronic control units..... 30
- Event Data Recorder..... 33
- MBUX multimedia system/Mercedes me connect..... 33
- Online services..... 32
- Deactivating the alarm**..... 90
- Dealership**..... 27
- Declaration of conformity**
- Components relevant to radio regulation.. 25
- Decorative foil**..... 285
- Definitions**
- Tires and loading..... 332
- Deployed components**
- Limited protection..... 48
- Deployment situations**..... 46
- Destination entry**..... 244
- Detecting inattentiveness**..... 174
- Diagnostics connection**..... 26
- Digital Operator's Manual**..... 18
- Dinghy towing**
- Pulling/towing..... 219
- DIRECT SELECT lever**
- Automatic transmission..... 150

- Engages neutral..... 152  
Engaging drive position..... 153  
Engaging park position automatically..... 152  
Engaging reverse gear..... 151  
Function..... 150  
Gearshift recommendation..... 154  
Manual gearshifting..... 153  
Selecting park position..... 152
- Display**  
Care..... 287
- Display (driver's display)**  
Overview of displays..... 224
- Display message**  
Calling up on driver display..... 358  
Notes..... 358
- Display messages**
-  --- mph..... 391
  -  --- mph..... 390
  -  12 V On-board Electrical System Service Required..... 400
  -  48 V Battery See Operator's Manual..... 402
  -  Active Headlamps Inoperative..... 366
  -  Add Washer Fluid..... 373
  -  ATTENTION ASSIST: Take a Break!..... 389
  -  Automatic Driving Lights Inoperative..... 365
  -  Battery Overheated Stop! Everyone Get Out! Outdoors if Possible.. 402
  -  Camera View Reduced See Operator's Manual..... 398
  -  Check Brake Fluid Level..... 385
  -  Check Coolant Level See Operator's Manual..... 374
  -  Check Engine Oil Level At Next Refueling (Add 1 Quart)..... 409
  -  Check Left Low Beam (example).. 365
  -  Check Tires..... 404
  -  Coolant Stop Switch Off Vehicle... 375
  -  Currently Unavailable See Operator's Manual..... 386
  -  Currently Unavailable See Operator's Manual..... 387
  -  Do Not Leave People or Animals in the Vehicle..... 362
  -  Don't Forget Your Key..... 364
  -  Dynamic Low Beam Inoperative... 366
  -  Engine Oil Level Cannot Be Measured..... 410
  -  Engine Oil Level Reduce Oil Level..... 409
  -  Engine Oil Level Stop Switch Off Vehicle..... 409
  -  Engine Oil Pressure Stop Switch Off Vehicle..... 410
  -  Front Left Malfunction Service Required (Example)..... 359
  -  Fuel Filler Cap Open..... 376
  -  Fuel Reserve..... 375
  -  Initializing Key Please Wait..... 364
  -  Initiating Emergency Stop..... 395

 Inoperative See Operator's Manual..... 387	 Parking Brake See Operator's Manual..... 381	 Stop Vehicle To Charge the 12 V Battery Do Not Switch Off Vehicle..... 402
 Inoperative See Operator's Manual..... 388	 Parking Lock Inoperative Apply Parking Brake..... 379	 Suspended..... 391
 Inoperative See Operator's Manual..... 389	 Please Correct Tire Pressure..... 405	 Switch Off Lights..... 366
 Inoperative..... 400	 Please Wait Charging 48 V Battery..... 403	 Switch On Headlights..... 366
 Key Not Detected (red display message)..... 363	 Reduce Speed..... 407	 Switch on vehicle to charge the 12 V battery..... 401
 Key Not Detected (white display message)..... 363	 Release Parking Brake..... 384	 Switch on Vehicle to Release the Parking Brake..... 384
 Left Window Airbag Malfunction Service Required (Example)..... 359	 Replace Key Battery..... 362	 Temporarily Unavailable Sensors Dirty..... 397
 Malfunction Do Not Exceed 50 mph..... 391	 Restraint System Malfunction Service Required..... 359	 Tires Overheated..... 406
 Malfunction See Operator's Manual..... 365	 Steering Malfunction Increased Physical Effort See Operator's Manual.... 371	 Transmission Oil Overheated Drive with Caution..... 379
 Obtain a New Key..... 362	 Steering Malfunction See Operator's Manual..... 371	 Turn Steering Wheel Before Starting Vehicle..... 372
 Off..... 392	 Steering Malfunction Stop Immediately See Operator's Manual..... 371	 Warning Tire Malfunction..... 406
 Off..... 389	 Stop Vehicle See Operator's Manual..... 401	 Wheel Sensor(s) Missing..... 404
		Active Brake Assist Functions Currently Limited See Operator's Manual.... 393

- Active Brake Assist Functions Limited  
See Operator's Manual..... 393
- Active Distance Assist Currently  
Unavailable See Operator's Manual..... 392
- Active Distance Assist Inoperative..... 392
- Active Distance Assist Now Available..... 393
- Active Lane Keeping Assist Currently  
Unavailable See Operator's Manual..... 396
- Active Lane Keeping Assist Inoperative... 396
- Active Lane Keeping Assist Limited  
Range of Functions See Operator's  
Manual..... 396
- Active Parking Assist and  
PARKTRONIC Inoperative See Opera-  
tor's Manual..... 399
- Active Steering Assist Currently  
Unavailable Due to Multiple Emer-  
gency Stops..... 395
- Active Steering Assist Currently  
Unavailable See Operator's Manual..... 394
- Active Steering Assist Inoperative..... 394
- Adaptive Highbeam Assist Currently  
Unavailable See Operator's Manual..... 367
- Adaptive Highbeam Assist Inoperative.... 367
- Auxiliary Battery Malfunction (red dis-  
play message)..... 380
- Auxiliary Battery Malfunction (white  
display message)..... 380
- Blind Spot Assist Currently Unavaila-  
ble See Operator's Manual..... 395
- Blind Spot Assist Inoperative..... 396
- Cannot Start Vehicle See Operator's  
Manual..... 369
- Check Brake Pads See Operator's  
Manual..... 385
- Check Tire and Tire Pressure..... 407
- Check Tire Pressure Then Restart Run  
Flat Indicator..... 408
- Cruise Control Inoperative..... 390
- Cruise Control Off..... 390
- Depress Brake to Shift from P..... 376
- Depress Brake to Shift to D or R..... 377
- Depress Brake to Shift to R..... 377
- Front Passenger Airbag Disabled See  
Operator's Manual..... 360
- Front Passenger Airbag Enabled See  
Operator's Manual..... 360
- Hazard Warning Light Malfunction..... 367
- Head-up Display Currently Unavaila-  
ble See Operator's Manual..... 370
- Head-up Display Inoperative..... 370
- N Permanently Active Risk of Rolling  
Away..... 378
- Occupant Presence Reminder Inoper-  
ative..... 361
- PARKTRONIC Inoperative See Opera-  
tor's Manual..... 399
- Place the Key in the Marked Space  
See Operator's Manual..... 364

- PRE-SAFE Inoperative See Operator's Manual..... 399
- Reduced Drive System Performance See Operator's Manual..... 368
- Reversing Not Possible Service Required..... 378
- Risk of Vehicle Rolling Away Apply Parking Brake When Parking..... 377
- Risk of Vehicle Rolling Away Driver's Door Open Position P Not Selected..... 377
- Run Flat Indicator Inoperative..... 408
- Service Required Apply Parking Brake to Park..... 377
- Service Required Do Not Change Transmission Position..... 378
- Shift to P Only When Vehicle Is Stationary..... 376
- Starting Possible Again..... 403
- Teaching in Transmission Complete..... 380
- Teaching in Transmission Operate Selector Lever Apply Brake for XX s Risk of Vehicle Rolling Away..... 379
- Tire Pressure Monitor Currently Unavailable..... 403
- Tire Pressure Monitor Inoperative..... 404
- Tire Pressure Monitor Inoperative Tire Pressure Sensors Missing..... 404
- To Deselect P or N Depress Brake and Start Vehicle..... 376
- To Switch Off Vehicle Press and Hold Start/Stop Button for at Least 3 Seconds or Press 3 Times..... 374
- Traffic Sign Assist Currently Unavailable See Operator's Manual..... 390
- Traffic Sign Assist Inoperative..... 390
- Transmission Malfunction..... 379
- Transmission Malfunction Service Required..... 380
- Transmission Malfunction Stop..... 378
- Vehicle Ready to Drive Shutdown Occurs When Locked or After a Few Minutes..... 369
- Vehicle Ready to Drive Shutdown Occurs When Locked or Automatically in XX Mins..... 370
- Windshield Wiper Malfunction..... 374
- Displaying road names/house numbers..... 245**
- Distance control..... 178**
- Distance warning..... 188**
- DISTRONIC..... 178**
- Door**
- Child safety lock (rear door)..... 66
- Emergency key..... 76
- Opening (from the inside)..... 73
- Unlocking (inside)..... 73
- Door operating unit**
- Function seat..... 14
- DOT, Tire Identification Number (TIN)..... 327**
- Drinking and driving..... 140**
- Drive Away Assist..... 217**



- Drive position**..... 153  
**Drive program display**..... 149  
**Drive programs**  
   Selecting..... 149  
**Driver's display**, Instrument cluster  
   48 V on-board electrical system..... 224  
   Head-up display..... 222  
   Instrument cluster..... 8  
   Menus..... 221  
   Notes..... 220  
   Operating..... 220  
   Service due date..... 273  
   Status displays..... 224  
   Warning/indicator lamps..... 411  
**Driver's seat**  
   Adjusting (Seat Comfort)..... 95  
   Adjusting (without seat comfort)..... 93  
   Adjusting electrically..... 98  
   Easy entry and exit feature..... 104  
   Seat heating..... 101  
**Driving safety system**  
   ABS (Anti-lock Braking System)..... 169  
   Active Brake Assist..... 188  
   Active Steering Assist..... 185  
   ATTENTION ASSIST..... 174  
   BAS (Brake Assist System)..... 169  
   Blind Spot Assist..... 197  
   Cameras..... 167  
   Cruise control..... 176  
   EBD (Electronic Brakeforce Distribution)..... 171  
   ESP® (Electronic Stability Program)..... 170  
   Hill Start Assist..... 173  
   HOLD function..... 172  
   Overview..... 168  
   Radar and ultrasonic sensors..... 167  
   STEER CONTROL..... 172  
   Traffic Sign Assist..... 193  
   Your responsibility..... 167  
**Driving system**..... 168  
**Driving tips**  
   Drinking and driving..... 140  
   General driving tips..... 140  
   Notes on breaking in a new vehicle..... 140  
**Drowsiness detection**..... 174  
**Duplicate key**..... 72  
**Dynamic handling control system**..... 170  
**DYNAMIC SELECT**  
   Calling up the fuel consumption indicator..... 150  
   Configuring drive program I..... 149  
   Displaying engine data..... 150  
   Displaying vehicle data..... 150  
   Drive program display..... 149  
   Drive programs..... 148  
   Function..... 148  
   Selecting the drive program..... 149
- E**
- E10**..... 351  
**Easy entry feature**  
   Adjusting..... 105  
   Function..... 104  
**Easy exit feature**  
   Adjusting..... 105  
   Function..... 104  
**EBD**, Electronic Brakeforce Distribution..... 171  
**ECO Assist**  
   48 V on-board electrical system..... 146  
**ECO display**..... 145

- ECO start/stop button**  
Automatic engine start/stop..... 145
- ECO start/stop function**  
Automatic engine start..... 144  
Automatic engine stop..... 144  
Function..... 144  
Switching off/on..... 145
- Electric parking brake**  
Applying automatically..... 163  
Emergency braking..... 165  
Manually applying/releasing..... 164  
Releasing automatically..... 164
- Electrical fuses**..... 310
- Electronic Stability Program**..... 170
- Emergency**  
Assistance overview..... 16  
First-aid kit (soft sided)..... 293  
Reflective safety vest..... 291  
Warning triangle..... 292
- Emergency braking**  
Active Brake Assist..... 188  
Brake Assist System..... 169  
Carrying out..... 165  
Electric parking brake/handbrake..... 163
- Emergency key**  
Door..... 76
- Emergency operation mode**  
Starting the vehicle..... 138
- Emergency release**  
Trunk lid (from inside)..... 81
- Emergency spare wheel**  
Inflating..... 344
- Emergency stop assistant**..... 187
- Emergency Tensioning Devices**  
Inflating..... 46
- Engine**  
Emergency operation mode..... 138  
Emergency start..... 310  
Engine number..... 348  
Jump-starting..... 302  
Parking (start/stop button)..... 158
- Engine data**  
Displaying..... 150  
DYNAMIC SELECT..... 150
- Engine number**..... 348
- Engine oil, Oil**  
Additives..... 353  
Capacity..... 353  
Checking the oil level using the driver display..... 277  
MB-Freigabe or MB-Approval..... 353  
Quality..... 353  
Refilling..... 278  
Temperature (driver's display)..... 222
- Engine oil temperature (driver's display)**..... 222
- Engine output, current (driver's display)**..... 222
- Environmentally friendly driving**..... 19
- ESC, Electronic Stability Control**..... 170
- ESP®**  
Activating/deactivating..... 171  
Crosswind Assist..... 171  
Function..... 170
- Event Data Recorder**..... 33
- Exit warning**  
Blind Spot Assist..... 197
- Exiting a parking space**  
Active Parking Assist..... 212  
Drive Away Assist..... 217  
PARKTRONIC..... 208

- Exterior lighting**  
 Care..... 286
- Exterior mirrors**  
 Parking position..... 130
- F**
- Factory settings**  
 MBUX reset function..... 240
- Favorites**..... 234
- Film coverings**  
 On camera/sensors..... 167
- First aid**  
 First-aid kit (soft sided)..... 293
- First-aid kit (soft sided)**..... 293
- Fitting accessories**  
 Limited protection..... 48
- Flat tire**  
 Changing a wheel..... 338  
 MOExtended..... 294  
 Notes..... 293  
 TIREFIT kit..... 295
- Flat towing**  
 Pulling/towing..... 219
- Floor mats**..... 118
- Fog lamp**..... 121
- Foil covering**  
 Radar and ultrasonic sensors..... 167
- Free software**..... 34
- Frequencies**  
 Mobile phone..... 347  
 Two-way radio..... 347
- Front air bag**  
 Inflating..... 46
- Front headlamps**..... 120
- Front passenger air bag**  
 Disabling/enabling..... 42
- Front passenger air bag shutoff,**  
 PASSENGER AIR BAG OFF  
 Information (child restraint system on  
 the front passenger seat)..... 57
- Front passenger seat**  
 Adjusting (Seat Comfort)..... 95  
 Adjusting (without seat comfort)..... 93  
 Adjusting electrically..... 98
- Fuel**  
 Additives..... 352
- E10..... 351  
 Gasoline..... 351  
 Quality (gasoline)..... 351  
 Refilling..... 156  
 Reserve..... 353  
 Sulfur content..... 351  
 Tank capacity..... 353
- Fuel consumption indicator**..... 150
- Fuel reserve**..... 353
- Function in the event of an accident**..... 46
- Function seat**..... 14
- Fuses**  
 Engine compartment..... 311  
 Fuse assignment diagram..... 310  
 Notes..... 310  
 Passenger footwell..... 312  
 Trunk..... 313
- G**
- G-meter, Accelerometer**..... 222
- Garage door opener**  
 Clearing the memory..... 163  
 Opening/closing a door..... 162  
 Problem..... 162

- Garage door openers**  
 Programming buttons..... 160  
 Synchronizing the rolling code..... 162
- Gasoline**..... 351
- Gearshift**  
 DIRECT SELECT lever..... 150  
 Manual..... 153
- General driving tips**..... 140
- Genuine parts**..... 19
- Glide mode**..... 155
- Glove box**  
 Locking/unlocking..... 110
- Grab handles**..... 93
- H**
- Handbrake**..... 163
- Handling characteristics**  
 Unusual..... 314
- HANDS-FREE ACCESS**..... 79
- Hazard warning lights**..... 122
- Hazard warnings**  
 Car-to-X-Communication..... 247
- Head restraint**  
 Adjusting (rear passenger compartment)..... 100  
 Adjusting manually (front)..... 99  
 Removing/installing (rear passenger compartment)..... 100
- Head-up display**  
 Care..... 287  
 Function..... 222  
 Memory function..... 106  
 Operating..... 223  
 Switching on/off..... 224
- Headlamp flashing**..... 121
- Headlamps**..... 120
- Heating**  
 Activating/deactivating..... 132  
 Seat..... 101
- Help call**  
 Mercedes-Benz emergency call system.. 263
- High beam**..... 121
- Hill Start Assist**..... 173
- HOLD function**  
 Function..... 172
- Switching on/off..... 172
- Home screen**  
 Central display..... 227
- Hood**  
 Opening/closing..... 275
- I**
- Identification plate**  
 Engine..... 348  
 Refrigerant..... 355  
 Vehicle..... 348
- Immobilizer**..... 89
- Incorrect behavior by vehicle occupants**  
 Limited protection..... 48
- Indicator/warning lamps**  
 Driver's display..... 411  
 PASSENGER AIR BAG..... 41
- Individual drive program**  
 Configuring..... 149
- Inside rearview mirror**..... 129
- Installing**  
 Snow chains..... 315  
 Tires/wheels..... 342

- Instrument panel**  
 Cockpit..... 6
- Interior lighting**  
 Adjusting..... 125  
 Ambient lighting..... 125  
 MBUX reading light..... 232  
 Switch-off delay time..... 126
- Interior protection**..... 91
- Internet**  
 Mercedes me connect..... 258  
 Setting up a Wi-Fi hotspot..... 238  
 Web browser..... 261
- ISOFIX child seat anchor**  
 Installing..... 62
- J**
- Jack**  
 Storage location..... 337
- Jump-start connection**..... 303
- K**
- Key**  
 Problem..... 72  
 Replacement key..... 72
- KEYLESS-GO**  
 Deactivating..... 70  
 Locking/unlocking the vehicle..... 74  
 Problem..... 75  
 Unlocking setting..... 70
- Kickdown**..... 155
- Knee bag**..... 52
- L**
- Lane Keeping Assist**..... 198
- Lane recognition**  
 Active Lane Keeping Assist..... 198
- Language**  
 Notes..... 240  
 Setting..... 240
- License plate (front)**..... 25
- License plate assembly (front)**..... 25
- Light switch**..... 120
- Lighting**  
 Interior lighting..... 125
- Lights**  
 Active headlamps..... 123  
 Adaptive Highbeam Assist..... 123
- Automatic driving lights..... 121  
 Combination switch..... 121  
 Cornering light function..... 122  
 Hazard warning lights..... 122  
 High beam..... 121  
 Interior lighting..... 125  
 Locator lighting..... 124  
 Reading lamp..... 125  
 Reading light..... 232  
 Rear fog light..... 121  
 Responsibility for lighting systems..... 120  
 Switch-off delay time..... 124  
 Turn signals..... 121
- Limited Warranty**..... 29
- Live Traffic Information**..... 247
- Load index**  
 Tires..... 329
- Load-bearing capacity**  
 Tires..... 329
- Loading**  
 Definitions..... 332  
 Notes..... 107  
 Roof luggage rack..... 113  
 Tie-down eyes..... 113

- Loading guidelines**..... 107  
**Loading information table**..... 322  
**Loads**..... 107  
**Locator lighting**..... 124  
**Locking/unlocking**  
     Automatic locking (MMS)..... 75, 76  
     Doors (from the inside)..... 73  
     Emergency key..... 76  
     KEYLESS-GO..... 74  
**Loud sound**  
     PRE-SAFE® Sound..... 44  
**Low-beam headlamps**  
     Activating/deactivating..... 120  
**Lubricants**..... 350  
**Luggage**..... 107  
**Luggage rack**..... 107  
**Lumbar support**..... 98
- M**
- Maintaining safe distance**  
     Active Distance Assist DISTRONIC..... 180  
**Maintaining the headliner**..... 287  
**Maintaining the steering wheel**..... 287  
**Maintenance**  
     Vehicle..... 22  
**Maintenance Management**  
     Notes..... 274  
     Transferred data..... 274  
**Malfunction**  
     Restraint system..... 39  
**Malfunction message**  
     Driver's display..... 358  
**Maneuvering**  
     Maneuvering brake function..... 218  
**Maneuvering assistant**  
     Activating/deactivating..... 219  
     Drive Away Assist..... 217  
     Maneuvering brake function..... 218  
**Maneuvering brake function**..... 218  
**Manual gearshifting**  
     Activating/deactivating..... 154  
**Map**  
     Displaying online map contents..... 247  
     Displaying weather information..... 247  
     Moving..... 247  
     Selecting the map orientation..... 247  
     Setting the map scale..... 247  
**Map functions**..... 247  
**Massage programs**..... 101  
**Maximum full-stop braking**..... 169  
**Maximum load rating**..... 328  
**Maximum permissible load**  
     Calculation example..... 324  
     Determining..... 323  
**Maximum tire pressure**..... 329  
**MBUX**  
     Dashcam..... 249  
**MBUX Interior Assistant**  
     Overview..... 230  
     Reading light..... 232  
     Search light..... 232  
**MBUX multimedia system**  
     Activating/deactivating standby mode... 167  
     Drive programs..... 149  
     Factory setting..... 240  
     Home screen..... 227  
     Language settings..... 229  
     MBUX Interior Assistant..... 230

- Media..... 266
  - Mercedes me & Apps..... 260
  - Notes..... 226
  - Overview..... 226
  - Set collision detection..... 165, 166
  - Setting route-based speed adaptation.... 184
  - Standby mode function..... 166
  - Telephone..... 252
  - Touchscreen..... 228
  - MBUX reading light**..... 232
  - MBUX search light**..... 232
  - MBUX Voice Assistant**
    - Function..... 229
    - Voice prompting..... 230
  - Mechanical key**
    - Inserting/removing..... 71
  - Media**
    - Overview of functions/symbols..... 266
  - Medical aids**..... 28
  - Memory function**
    - Head-up display..... 106
    - Outside mirrors..... 106
    - Seat..... 106
  - Menus (driver's display)**
    - Notes..... 221
    - Sport..... 222
  - Mercedes me App**
    - Activating on-demand features..... 22
  - Mercedes me Apps**..... 260
  - Mercedes me calls**
    - Arranging a service appointment..... 257
    - Calling the Mercedes-Benz customer center after automatic accident/breakdown detection..... 256
    - Calls via the overhead control panel..... 255
    - Information..... 255
    - Mercedes-Benz customer center..... 256
    - Transferred data..... 257
  - Mercedes me connect**
    - Accident/Breakdown Management..... 259
    - Information..... 258
    - Transferred data..... 260
  - Mercedes-AMG vehicles, Notes**..... 136
  - Mercedes-Benz emergency call system,**
    - Emergency call
      - Automatic emergency call..... 263
      - Data transfer..... 264
    - Information..... 262
    - Manual emergency call..... 264
    - Overview..... 263
  - Mercedes-Benz GenuineParts**..... 19
  - Message memory**..... 358
  - Mirrors**
    - Mirror folding function..... 131
    - Outside mirrors..... 128
    - Rearview mirror..... 129
  - Mobile phone**
    - Frequencies..... 347
    - Maximum transmission output..... 347
    - Notes on wireless charging..... 116
  - Model type**..... 348
  - Modification**
    - Limited protection..... 48
  - MOExtended tires, Run-flat tires**..... 294
  - Multimedia system**..... 226
- N**
- Navigation**
    - Activating..... 241
    - Destination entry..... 244

- Notes..... 241
- Overview..... 241
- Neutral**..... 152
- Non-operational time**
  - Activating/deactivating standby mode... 167
- Notes on breaking in a new vehicle**..... 140
- O**
- Objects in the vehicle interior**
  - Limited protection..... 48
- Occupant presence reminder**
  - Activating/deactivating..... 68
  - Function..... 67
- Occupant safety**
  - Air bag..... 52
  - Basic information..... 36
  - Child seat..... 53
  - Information on the child restraint system..... 43
  - Information on the correct seat position... 37
  - Occupant presence reminder..... 67
  - Pets in the vehicle..... 48
  - PRE-SAFE®..... 44
- On-board diagnostics interface**..... 26
- On-board electronics**
  - Two-way radios..... 346
- On-demand feature**..... 21, 22
- Online services**..... 32
- Open Source Software**..... 34
- Opening the trunk lid using your foot**
  - HANDS-FREE ACCESS..... 79
- Opening/closing a door**..... 162
- Opening/closing a garage door**..... 162
- Operating fluids**
  - Additives..... 352
  - Brake fluid..... 354
  - coolant..... 354
  - Engine oil..... 353
  - Fuel (gasoline)..... 351
  - Notes..... 350
  - Refrigerant (air conditioning system)..... 355
  - Windshield washer fluid..... 355
- Operating safety**
  - 48 V on-board electrical system..... 23
- Operator's manual**..... 20
- Operator's Manual digital**..... 18
- Outside mirrors**
  - Automatic anti-glare mode..... 129
  - Automatic mirror folding function..... 131
  - Blind Spot Assist..... 197
  - Folding in/out..... 128
  - Memory function..... 106
  - Setting..... 128
  - Warning lamp..... 197
- Overhead control panel**..... 12
- P**
- Paddle shifters**
  - Steering wheel paddle shifters..... 153
- Paint code**..... 348
- Panic alarm, Alarm**
  - Activating/deactivating..... 70
- Park position**
  - DIRECT SELECT lever..... 150
- Parking**
  - Active Parking Assist..... 212
  - PARKTRONIC..... 208



<b>Parking Assist</b>		<b>PASSENGER AIR BAG</b>		<b>Protection</b>	
Active Parking Assist.....	212	Status display, front passenger air bag.....	41	Limited.....	48
PARKTRONIC.....	208	<b>Payload</b>		<b>Protection against collision</b>	
<b>Parking Assist PARKTRONIC</b>		Calculation example.....	324	Maneuvering brake function.....	218
Activating/deactivating.....	211	Determining the maximum.....	323	<b>Protection of the environment</b>	
Adjusting warning tones.....	212	<b>Permitted towing methods</b>		Driving style.....	19
Function.....	208	Overview.....	305	<b>Pulling away</b>	
<b>Parking assistance systems</b>		<b>Personalization</b> .....	233	Hill Start Assist.....	173
Active Parking Assist.....	212	<b>Pets in the vehicle</b> .....	48	Start-off assist.....	174
Drive Away Assist.....	217	<b>Post-collision brake</b> .....	46		
Maneuvering brake function.....	218	<b>Power supply</b>		<b>Q</b>	
PARKTRONIC.....	208	Start/stop button.....	136	QR code rescue card.....	29
<b>Parking brake</b> .....	163	Switching on (start/stop button).....	136	<b>Qualified specialist workshop</b> .....	27
<b>Parking for an extended period</b> .....	166	<b>Power washer</b> .....	284		
<b>Parking lamps</b> .....	120	<b>PRE-SAFE®</b> , Anticipatory occupant protection		<b>R</b>	
<b>Parking lights</b> .....	120	Function.....	44	Radar and ultrasonic sensors.....	167
<b>Parking position</b>		PRE-SAFE® Sound.....	44	<b>Radio</b> .....	268
Exterior mirrors.....	130	Reverting measures.....	45	<b>Radio regulations</b>	
Storing the position of the front-passenger outside mirror using reverse gear.....	131	<b>Preventative occupant protection system</b> .....	44	Regulatory radio identification.....	348
<b>PARKTRONIC</b> .....	208	<b>Profile</b> .....	233	<b>Rain closing function</b>	
		<b>Programs</b> .....	148	Sliding sunroof.....	88
				<b>Rain sensor</b>	
				Sliding sunroof.....	88

- Windshield wipers..... 126
- Reading lamp**  
Interior lighting..... 125
- Rear door (child safety lock)**  
Securing..... 66
- Rear fog light**..... 121
- Rear passenger compartment seat belt**  
Status display..... 40
- Rear view camera**  
360° Camera..... 201  
Function..... 201  
Opening the camera cover..... 208
- Rear window heater**..... 132
- Rearview mirror**  
Automatic anti-glare mode..... 129
- Rearward-facing child seat**  
Information..... 59
- Reflective safety vest**..... 291
- Refrigerant**..... 355
- Refueling**  
Fuel..... 156  
Refueling the vehicle..... 156
- Regulatory radio information**  
Specific absorption rate..... 348
- Remote Online**  
Charging the starter battery..... 139  
Cooling/heating the vehicle interior..... 139  
Starting the vehicle..... 139
- Replacement key**..... 72
- Reporting safety defects**..... 29
- Reserve**  
Fuel..... 353
- Resetting**  
MBUX reset function..... 240
- Residual heat**..... 134
- Responsibility**  
Driving safety systems..... 167
- Restraint system**  
Basic information..... 36  
Basic instructions for children..... 53  
Deployment situations..... 46  
Functionality..... 39  
Information on function..... 46  
Information on the correct seat position... 37  
Limited protection..... 48  
Malfunction..... 39  
Protection..... 37  
Self-test..... 39  
Warning lamp..... 39
- Reverse gear**  
DIRECT SELECT lever..... 150
- Roadside Assistance (breakdown)**..... 22
- Roll away protection**..... 172
- Roller sunblind**  
Sliding sunroof..... 85
- Roof luggage rack**  
Loading..... 113  
Securing..... 113
- Route**  
Alternative route..... 245  
Calculating..... 245  
Commuter route..... 245  
Navigation..... 241  
Selecting a type..... 245
- Route guidance with augmented reality**  
Activating..... 245  
Activating/deactivating the traffic  
light view..... 196

- Displaying road names/house numbers..... 245
- Switching video on or off..... 245
- Route-based speed adaptation**
  - Function..... 183
  - Setting..... 184
- Run-flat characteristics**..... 294
- S**
- Safety system**..... 168
- Satellite radio**
  - Logging in..... 271
  - Setting music and sport alerts..... 271
- Seat, Through-loading feature**
  - Adjusting (Seat Comfort)..... 95
  - Adjusting (without seat comfort)..... 93
  - Adjusting electrically..... 98
  - Automatic adjustment..... 100
  - Correct driver's seat position..... 92
  - Folding back the backrest (rear passenger compartment)..... 112
  - Folding backrest forward (rear)..... 110
  - Locking the backrest (rear passenger compartment)..... 112
- Lumbar support..... 98
- Memory function..... 106
- Resetting settings (massage programs).. 101
- Settings..... 14
- Side impact air bag..... 52
- Seat belt**
  - Automatic tightening..... 45
  - Rear passenger compartment seat belt status display..... 40
  - Warning lamp..... 40
- Seat belt adjustment**
  - Activating/deactivating..... 45
  - Function..... 45
- Seat belt warning**..... 40
- Seat belts**
  - Activating/deactivating seat belt adjustment..... 45
  - Care..... 287
  - Fastening..... 39
  - Notes on wearing correctly..... 38
  - Releasing..... 52
- Seat heating**
  - Activating/deactivating..... 101
- Seat ventilation**
  - Activating/deactivating..... 102
- Selecting a gear**..... 153
- Selector lever**..... 150
- Self-test**
  - Automatic front passenger air bag shut off..... 41
  - Restraint system..... 39
- Sensors**
  - Cleaning..... 286
  - Information..... 167
- Service**..... 273
- Service center**..... 27
- Service due date**..... 273
- Service interval display**..... 273
- Shifting**
  - Automatic transmission..... 153
  - Gearshift recommendation..... 154
  - Manual..... 153
  - Steering wheel paddle shifters..... 153
- Shortening the braking distance**
  - Brake Assist System..... 169

- Shunting support**..... 218
- Side impact air bag**..... 52
- Side windows**
- Child safety lock (rear passenger compartment)..... 67
  - Closing with SmartKey..... 84
  - Convenience closing feature..... 84
  - Convenience opening..... 83
  - Opening with the SmartKey..... 83
  - Opening/closing..... 81
  - Problem..... 84
- Size designation**
- Tires..... 329
- Skid chains**..... 315
- Sliding sunroof, Panorama roof with power tilt/sliding panel**
- Automatic functions..... 88
  - Closing with SmartKey..... 84
  - Opening with the SmartKey..... 83
  - Opening/closing..... 85
  - Problem..... 88
  - Rain closing function..... 88
- SmartKey**
- Acoustic locking verification signal..... 70
  - Battery..... 71
  - Deactivating a function..... 70
  - Function..... 69
  - Key ring attachment..... 71
  - Mechanical key..... 71
  - Panic alarm..... 70
  - Power consumption..... 70
  - Unlocking setting..... 70
- Smartphone Integration, iPhone®**
- Android Auto..... 261
  - Apple CarPlay®..... 261
- Snow chains**..... 315
- Socket**
- 12 V (front center console)..... 115
  - 12 V (trunk/cargo compartment)..... 115
  - 115 V (rear passenger compartment)..... 115
- Software update**..... 236
- SOS button**..... 255
- Sound**
- Menu..... 272
  - PRE-SAFE® Sound..... 44
  - Wheels/tires..... 314
- Sound settings**..... 272
- Spare parts**..... 19
- Spare wheel**..... 343
- Special seat belt retractor**..... 61
- Specialist workshop**..... 27
- Specific absorption rate (SAR)**..... 348
- Speed**
- Save, cruise control..... 180
  - Save, DISTRONIC..... 180
- Speed adaptation, Route-based**..... 183
- Speed control**
- Active Distance Assist DISTRONIC..... 178
  - Cruise control..... 176
- Speed rating**
- Tires..... 329
- Start-off assist**
- Activating..... 174
  - Function..... 174
  - Hill Start Assist..... 173
- Start/stop button**
- Parking the vehicle..... 158
  - Starting the vehicle..... 137
  - Switching on the power supply / vehicle..... 136

- Start/stop function**..... 144
- Starter battery**  
charging, Remote Online..... 139
- Starting**  
Remote Online..... 139  
Start/stop button..... 137
- Starting assistance**..... 303
- Starting the engine**  
Emergency operation mode..... 138  
Remote Online..... 139  
Start/stop button..... 137
- Starting-off aid**  
Drive Away Assist..... 217  
Hill Start Assist..... 173  
Start-off assist..... 174
- Status display**  
Front passenger air bag..... 41  
Rear passenger compartment seat belt... 40
- Steer Assist**  
Active Steering Assist..... 185  
STEER CONTROL..... 172
- STEER CONTROL**..... 172
- Steering wheel**  
Driver's air bag..... 52  
Manually adjusting..... 103  
Steering wheel heater..... 104
- Steering wheel heater**..... 104
- Steering wheel paddle shifters**..... 153
- Stop and go**  
ECO start/stop function..... 145
- Stopping**  
Parking the vehicle..... 158
- Stowage areas**..... 110
- Stowage spaces**  
Armrest (front)..... 110  
Center console (front)..... 110  
Door..... 110  
Glove box..... 110
- Substances hazardous to health**..... 23
- Sulfur content**..... 351
- Suspension**  
Adaptive damping system..... 201
- Switch-off delay time**  
Exterior..... 124  
Interior..... 126
- Switching air-recirculation mode on/off**..... 134
- Synchronization function**  
Activating/deactivating (control panel)... 134
- System settings**  
MBUX reset function..... 240  
Overview..... 236
- T**
- Tank capacity**  
Fuel..... 353  
Reserve..... 353
- Tank filler cap / flap**..... 156
- Technical data**  
Information..... 346  
Radio frequencies..... 347  
Radio regulations..... 348  
Specific absorption rate (SAR)..... 348  
Vehicle dimensions..... 356
- Telediagnosis**  
Diagnostic data..... 274
- Telediagnosics**  
Transferred data..... 275

- Telephone, Smartphone**
- Bluetooth®..... 254
  - Charging wirelessly (mobile phone)..... 118
  - Connecting a mobile phone..... 254
  - Menu..... 254
  - Notes..... 252
  - Notes on wireless charging (mobile phone)..... 116
  - Operating modes..... 254
  - Secure Simple Pairing..... 254
  - Telephone menu overview..... 254
- Telephony operating modes**
- Bluetooth® telephony..... 254
- Temperature**
- Setting the vehicle interior temperature..... 132
- Temperature grade**..... 326
- Tie-down eyes**..... 113
- TIN (Tire Identification Number)**..... 327
- Tire and Loading Information placard**..... 322
- Tire characteristics**..... 329
- Tire information table**..... 322
- Tire labeling**
- Characteristics..... 329
  - DOT, Tire Identification Number (TIN)..... 327
  - Load index..... 329
  - Load-bearing capacity..... 329
  - Maximum tire load..... 328
  - Maximum tire pressure..... 329
  - Size designation..... 329
  - Speed rating..... 329
  - Temperature grade..... 326
  - Tire Quality Grading..... 326
  - Traction grade..... 326
  - Tread wear grade..... 326
- Tire pressure**
- Checking..... 319
  - Checking manually..... 318
  - Maximum..... 329
  - Notes..... 315
  - Restarting the tire pressure loss warning system..... 321
  - Tire pressure loss warning system, function..... 321
  - Tire pressure table..... 317
  - TIREFIT kit..... 295
- Tire pressure loss warning system**
- Function..... 321
  - Restarting..... 321
- Tire pressure monitor**
- Function..... 318
- Tire pressure monitoring system**
- Restarting..... 320
- Tire pressure table**..... 317
- Tire Quality Grading**..... 326
- Tire sealant**..... 295
- Tire tread**..... 314
- Tire-change tool**..... 337
- Tire-change tool kit**..... 337
- TIREFIT kit, Tire inflation compressor**
- Storage location..... 295
- Tires**
- Breakdown..... 293
  - Characteristics..... 329
  - Checking..... 314
  - Checking the tire pressure manually..... 318
  - Definitions..... 332
  - DOT, Tire Identification Number (TIN)..... 327
  - Installing..... 342

- Labeling..... 326
- Load index..... 329
- Load-bearing capacity..... 329
- Maximum pressure..... 329
- Maximum tire load..... 328
- MOExtended..... 294
- Noise..... 314
- Notes on installing..... 334
- Removing..... 341
- Removing/installing hub cap..... 338
- Removing/installing wheel trim..... 338
- Replacing..... 334, 338
- Restarting the tire pressure loss warning system..... 321
- Rotating..... 337
- Selecting..... 334
- Size designation..... 329
- Snow chains..... 315
- Speed rating..... 329
- Storing..... 337
- Temperature grade..... 326
- Tire and Loading Information placard..... 322
- Tire pressure loss warning system, function..... 321
- Tire pressure table..... 317
- Tire Quality Grading..... 326
- TIREFIT kit..... 295
- Traction grade..... 326
- Tread wear grade..... 326
- Unusual handling characteristics..... 314
- Toll system**
- Debiting toll fees..... 241
- Top Tether**..... 63
- Torque (driver's display)**..... 222
- Touch Control**
- Driver's display..... 220
- MBUX..... 228
- Touch-sensitive controls**..... 21
- Touchscreen**..... 228
- Tow bar system**
- Towing away..... 219
- Tow-away protection**..... 90
- Tow-starting**..... 310
- Towing**
- Towing methods..... 305
- Towing eye**
- Storage location..... 309
- Towing methods**
- Both axles on the ground..... 306
- Overview..... 305
- Traction grade**..... 326
- Traffic information**..... 247
- Traffic light view**
- Activating/deactivating..... 196
- Information..... 196
- Traffic light warning/display**..... 193
- Traffic Sign Assist**
- Function..... 193
- Setting..... 196
- Trailer drawbar, Pulling/towing**..... 219
- Transmission position display**..... 150
- Transmission positions**
- DIRECT SELECT lever..... 150
- Transporting**
- Vehicle..... 308
- Tread wear grade**..... 326
- Trunk lid**
- Closing..... 78
- Emergency release (from inside)..... 81

HANDS-FREE ACCESS.....	79
Limiter.....	81
Opening.....	77
<b>TuneIn Internet Radio.....</b>	<b>270</b>
<b>Turn signal indicator.....</b>	<b>121</b>
<b>Turn signals.....</b>	<b>121</b>
<b>Two-way radios</b>	
Frequencies.....	347
Installation.....	346
Transmission output.....	347
<b>U</b>	
<b>Unfastening.....</b>	<b>52</b>
<b>Unlocking setting.....</b>	<b>70</b>
<b>Updates.....</b>	<b>236</b>
<b>USB port</b>	
Rear passenger compartment.....	116
Storage compartments (front).....	110
<b>User profiles</b>	
Adding a user.....	234
Note.....	233
Selecting options.....	234

**V****Vehicle, Switching on the ignition**

48 V on-board electrical system.....	23
Activating, Remote Online.....	139
Activating/deactivating standby mode... ..	167
Correct use.....	27
Data storage.....	30
Diagnostics connection.....	26
Emergency key.....	76
Equipment.....	20
KEYLESS-GO.....	74
Limited Warranty.....	29
lock automatically (MMS).....	75, 76
Locking/unlocking (emergency key).....	76
Locking/unlocking (from inside).....	73
Lowering.....	342
Maintenance.....	22
Medical aids.....	28
Parking.....	158
Parking for an extended period.....	166
Problem notification.....	28
Pulling.....	219
QR code rescue card.....	29
Raising.....	339
Set collision detection.....	165, 166

Standby mode function.....	166
Starting (start/stop button).....	137
starting, emergency operation mode.....	138
Stopping.....	158
Switching off (start/stop button).....	158
Switching on (start/stop button).....	136
Towing away.....	305
Transporting.....	308
Ventilating / comfort opening.....	83





















**Vehicle cameras..... 167****Vehicle data**













Display, MBUX.....	150
Displaying, DYNAMIC SELECT.....	150
Turning circle.....	356
Vehicle height.....	356
Vehicle length.....	356
Vehicle width.....	356
Weights.....	357
Wheelbase.....	356

**Vehicle dimensions..... 356****Vehicle emergency start..... 310****Vehicle equipment..... 20****Vehicle identification plate**

Model type.....	348
-----------------	-----



- Paint code..... 348  
VIN..... 348
- Vehicle interior**  
Cooling/heating (Remote Online)..... 139
- Vehicle key**..... 69
- Vehicle operation outside the USA or Canada**..... 22
- Vehicle sensors**..... 167
- Vehicle start**  
Emergency operation mode..... 138  
Remote Online..... 139  
Start/stop button..... 137
- Vehicle tool kit**  
TIREFIT kit..... 295  
Towing eye..... 309
- Ventilating**..... 83
- Ventilation**..... 135
- Vents**  
Air vents..... 135
- VIN, Vehicle identification number**  
Engine compartment..... 348  
Identification plate..... 348  
Windshield..... 348
- Vision**  
Defrosting windows..... 134
- Voice assistant**  
Voice prompting..... 230
- W**
- Warning system**..... 89
- Warning triangle**..... 292
- Warning/indicator lamp**  
 ABS warning lamp..... 423  
 Active Brake Assist warning lamp..... 426  
 ATTENTION ASSIST warning lamp..... 425  
 Brakes warning lamp (Canada only)..... 422  
 Brakes warning lamp (USA only)... 422  
 Brakes warning lamp (yellow) (Canada only)..... 421  
 Check Engine warning lamp..... 418  
 Coolant warning lamp (red)..... 418
-  Coolant warning lamp (yellow)..... 418  
 Distance warning lamp..... 425  
 Electric parking brake indicator lamp (red) (Canada only)..... 420  
 Electric parking brake indicator lamp (red) (USA only)..... 420  
 Electric parking brake indicator lamp (yellow)..... 420  
 Electrical malfunction warning lamp..... 418  
 Engine operating temperature warning lamp..... 419  
 ESP® OFF warning lamp..... 424  
 ESP® warning lamp flashes..... 423  
 ESP® warning lamp lights up..... 424  
 Fuel reserve warning lamp flashes..... 419  
 Fuel reserve warning lamp lights up..... 419

-  Mercedes-Benz emergency call system warning lamp..... 426
-  Occupant presence reminder warning lamp (white)..... 414
-  Occupant presence reminder warning lamp (yellow)..... 414
-  Power steering warning lamp (red)..... 415
-  Power steering warning lamp (yellow)..... 415
-  RBS warning lamp (USA only)..... 421
-  Reduced warning lamp power..... 415
-  Restraint system warning lamp.... 413
-  Seat belt warning lamp flashes.... 413
-  Seat belt warning lamp lights up... 414
-  Tire pressure monitoring system warning lamp flashes..... 427
-  Tire pressure monitoring system warning lamp lights up..... 427
-  Traffic Sign Assist warning lamp... 425
- Warning/indicator lamps**  
 Driver's display..... 411  
 PASSENGER AIR BAG..... 41
- Washer fluid**  
 Topping up..... 280  
 Windshield washer fluid..... 355
- Washing by hand**..... 284
- Water tank**..... 281
- Wear**  
 Limited protection..... 48
- Weather information**..... 247
- Web browser**..... 261
- Weight information**..... 348
- Wheel change**  
 Installing a new wheel..... 342  
 Lowering the vehicle..... 342  
 Removing a wheel..... 341  
 Removing/installing hub caps..... 338  
 Removing/installing wheel trim..... 338
- Wheel rotation**..... 337
- Wheels**  
 Breakdown..... 293  
 Care..... 286
- Checking..... 314  
 Checking the tire pressure manually..... 318  
 Definitions..... 332  
 DOT, Tire Identification Number (TIN).... 327  
 Installing..... 342  
 Load index..... 329  
 Load-bearing capacity..... 329  
 Maximum tire load..... 328  
 Maximum tire pressure..... 329  
 MOExtended..... 294  
 Noise..... 314  
 Notes on installing..... 334  
 Removing..... 341  
 Removing/installing hub cap..... 338  
 Removing/installing wheel trim..... 338  
 Replacing..... 334, 338  
 Rotating..... 337  
 Selecting..... 334  
 Size designation..... 329  
 Snow chains..... 315  
 Speed rating..... 329  
 Storing..... 337  
 Temperature grade..... 326  
 Tire and Loading Information placard.... 322  
 Tire characteristics..... 329  
 Tire labeling..... 326

- Tire pressure..... 315
- Tire pressure monitor..... 318
- Tire Quality Grading..... 326
- TIREFIT kit..... 295
- Traction grade..... 326
- Tread wear grade..... 326
- Unusual handling characteristics..... 314
- Wi-Fi**
  - Setting up a hotspot..... 238
- Widescreen cockpit driver's display**
  - Instrument cluster..... 10
- Window curtain air bag**..... 52
- Windows**
  - Care..... 286
  - Convenience opening..... 83
  - Opening with the SmartKey..... 83
  - Opening/closing..... 81
  - Removing mist..... 134
- Windshield**
  - Defrosting..... 132
- Windshield washer fluid**..... 355
- Windshield washer system**..... 280
- Windshield wipers**
  - Activating/deactivating..... 126
  - Replacing the wiper blades..... 126
  - Replacing the wiper blades (windshield)..... 126
- Winter operation**
  - Snow chains..... 315
- Wiper blades**
  - Care..... 286
  - Replacing (windshield)..... 126
- Wipers**..... 126
- Wireless charging**
  - Mobile phone..... 118
  - Notes..... 116
- Workshop**..... 27

