



#### Digital – in the vehicle

Familiarize yourself with the contents of the Operator's Manual directly via the vehicle's multimedia system (menu item "Vehicle"). Start with the quick guide, discover your vehicle's highlights or broaden your knowledge with useful tips.



#### Vehicle document wallet

Here you can find comprehensive information about operating your vehicle and about services and warranties in printed form.



#### Digital – on the Internet

You can find the Operator's Manual on the Mercedes-Benz homepage.



#### Digital – as an App

The Mercedes-Benz Guides App is available free-of-charge in familiar App stores.

E-Class convertible



2385844702

Order no. P238 0205 13 Part no. 238 584 47 02  
Edition B-2018



Apple® iOS



Android™

Mercedes-Benz



## E-Class convertible

Operator's Manual

Mercedes-Benz



## Symbols

In this Operator's Manual, you will find the following symbols:

**⚠ DANGER** Danger due to not observing the warning notices

Warning notices draw your attention to hazards that may endanger your health or life, or the health or life of others.

▶ Please observe the warning notices in this manual.

**🌿 ENVIRONMENTAL NOTE** Environmental damage due to failure to observe environmental notes

Environmental notes include information on environmentally responsible behavior or environmentally responsible disposal.

▶ Observe environmental notes.

**! NOTE** Damage to property due to failure to observe notes on material damage

Notes on material damage inform you of risks which may lead to your vehicle being damaged.

▶ Observe notes on material damage.

**i** Useful instructions or further information that could be helpful to you.

▶ Instruction

( → page) Further information on a topic

**Display** Information in the multifunction display/multimedia display

↪ Highest menu level, which is to be selected in the multimedia system

▶▶ Corresponding submenus, which are to be selected in the multimedia system

\* Indicates a cause

## Publication details

### Internet

Further information about Mercedes-Benz vehicles and about Daimler AG can be found on the following websites:

<http://www.mbusa.com> (USA only)

<http://www.mercedes-benz.ca> (Canada only)

### Editorial office

©Daimler AG: Not to be reprinted, translated or otherwise reproduced, in whole or in part, without written permission from Daimler AG.

### Vehicle manufacturer

Daimler AG

Mercedesstrasse 137

70327 Stuttgart

Germany

## Welcome to the world of Mercedes-Benz

Before you first drive off, read this Operator's Manual carefully and familiarize yourself with your vehicle. For your own safety and a longer vehicle life, follow the instructions and warning notices in this Operator's Manual. Disregarding them may lead to damage to the vehicle or personal injury.

Vehicle damage resulting from the disregard of the instructions is not covered by the Mercedes-Benz Limited Warranty.

The equipment or model designation of your vehicle may vary according to:

- Model
- Order
- National version
- Availability

Mercedes-Benz reserves the right to introduce changes in the following areas:

- Design
- Equipment
- Technical features

The equipment in your vehicle may therefore differ from that shown in the descriptions and illustrations.

The following are integral parts of the vehicle:

- Digital Operator's Manual
- Printed Operator's Manual
- Maintenance Booklet
- Equipment-dependent supplements

Keep these documents in the vehicle at all times. If you sell the vehicle, always pass all of the documents on to the new owner.

Mercedes-Benz USA, LLC

Mercedes-Benz Canada, Inc.

A Daimler Company

2385844702



---

<b>At a glance</b> .....	6	QR codes for the rescue card .....	26	Seats .....	86
Cockpit .....	6	Vehicle data storage .....	26	Steering wheel .....	95
Warning and indicator lamps .....	8	Copyright .....	29	Using the memory function .....	98
Overhead control panel .....	12			Stowage areas .....	99
Door control panel and seat adjustment .....	14			Cup holder .....	105
Emergencies and breakdowns .....	16			Ashtray and cigarette lighter .....	106
				Sockets .....	107
				Wireless charging of the mobile phone and connection with the exterior antenna ..	108
				Installing or removing the floor mats .....	110
<b>Digital Operator's Manual</b> .....	18				
Calling up the Digital Operator's Manual .....	18				
<b>General notes</b> .....	19	<b>Occupant safety</b> .....	31	<b>Light and visibility</b> .....	111
Protecting the environment .....	19	Restraint system .....	31	Exterior lighting .....	111
Mercedes-Benz GenuineParts .....	19	Seat belts .....	33	Interior lighting .....	115
Operator's Manual .....	20	Airbags .....	38	Windshield wiper and windshield washer system .....	117
Service and vehicle operation .....	21	Roll bar .....	45	Mirrors .....	120
Operating safety .....	22	PRE-SAFE® system .....	46	Operating the sun visors .....	123
Declaration of conformity for wireless vehicle components .....	23	Children in the vehicle .....	47		
Diagnostics connection .....	24	Notes on pets in the vehicle .....	56		
Qualified specialist workshop .....	25				
Correct use of the vehicle .....	25				
Problems with your vehicle .....	25	<b>Opening and closing</b> .....	57	<b>Climate control</b> .....	124
Reporting safety defects .....	25	SmartKey .....	57	Overview of climate control systems .....	124
Limited Warranty .....	26	Doors .....	62	Operating the climate control system .....	125
		Trunk .....	65		
		Side windows .....	71		
		Soft top .....	76		
		Anti-theft protection .....	83		
		<b>Seats and stowing</b> .....	85		
		Notes on the correct driver's seat position ...	85		

---

<b>Driving and parking</b> .....	<b>131</b>
Driving .....	131
DYNAMIC SELECT switch .....	138
Automatic transmission .....	139
Refueling .....	143
Parking .....	145
Driving and driving safety systems .....	153
<hr/>	
<b>Instrument Display and on-board computer</b> .....	<b>199</b>
Instrument Display overview .....	199
Overview of the buttons on the steering wheel .....	200
Operating the on-board computer .....	200
Setting the additional value range .....	202
Overview of displays on the multifunction display .....	202
Adjusting the instrument lighting .....	203
Menus and submenus .....	203
Head-up Display .....	210
<hr/>	
<b>Voice Control System</b> .....	<b>212</b>
Notes on operating safety .....	212
Operation .....	212

Using the Voice Control System effectively .....	214
Essential voice commands .....	214

<b>Multimedia system</b> .....	<b>223</b>
Overview and operation .....	223
System settings .....	231
ENERGIZING comfort .....	243
Navigation .....	245
Telephone .....	269
Online and Internet functions .....	285
Media .....	292
Radio .....	304
Sound .....	311

<b>Maintenance and care</b> .....	<b>314</b>
ASSYST PLUS service interval display .....	314
Engine compartment .....	315
Cleaning and care .....	321

<b>Breakdown assistance</b> .....	<b>332</b>
Emergency .....	332
Flat tire .....	332

Battery (vehicle) .....	338
Tow starting or towing away .....	343
Electrical fuses .....	348

<b>Wheels and tires</b> .....	<b>352</b>
Notes on noise or unusual handling characteristics .....	352
Regular checking of wheels and tires .....	352
Notes on snow chains .....	353
Tire pressure .....	354
Loading the vehicle .....	360
Tire labeling .....	365
Definition of terms for tires and loading .....	370
Changing a wheel .....	373

<b>Technical data</b> .....	<b>383</b>
Notes on technical data .....	383
Vehicle electronics .....	383
Vehicle identification plate, VIN and engine number .....	385
Operating fluids .....	387
Vehicle data .....	393

## 4 Contents

---

<b>Display messages and warning/indicator lamps</b> .....	<b>395</b>
Display messages .....	395
Warning and indicator lamps .....	443
<hr/>	
<b>Index</b> .....	<b>461</b>

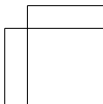
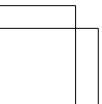
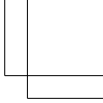
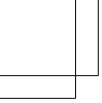

6 At a glance – Cockpit

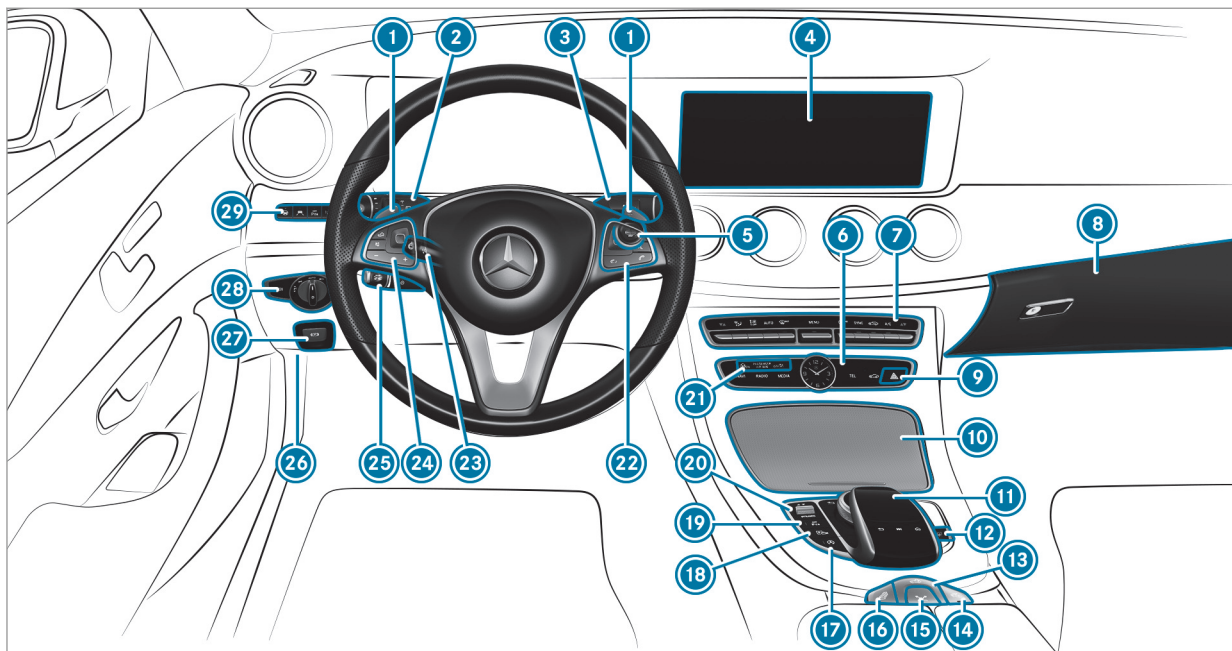





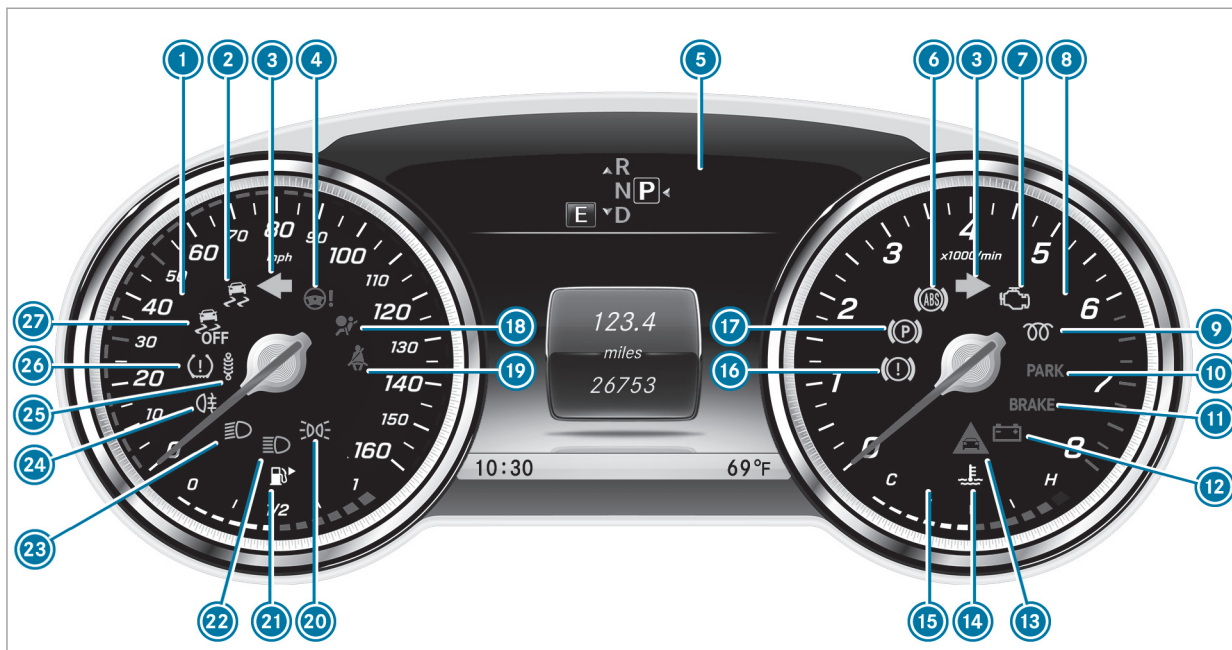























①	Steering wheel gearshift paddle	→	141	⑱	Active Parking Assist	→	185
②	Combination switch	→	112	⑲	Sets the vehicle level	→	173
③	DIRECT SELECT lever	→	139	⑳	DYNAMIC SELECT switch	→	138
④	Display (multimedia system)	→	223	㉑	PASSENGER AIRBAG indicator lamps	→	43,
⑤	Start/Stop button	→	132	㉒	Control panel for the multimedia system	→	200
⑥	Control panel for the multimedia system	→	223	㉓	Adjusts the steering wheel	→	96
⑦	Climate control systems	→	124	㉔	Control panel for the on-board computer	→	200
⑧	Glove box	→	101	㉕	Cruise control lever	→	160
⑨	Hazard warning lights	→	113	㉖	Unlocks the hood	→	315
⑩	Stowage compartment	→	100	㉗	Electric parking brake	→	150
⑪	Control elements for the multimedia system	→	223	㉘	Light switch	→	111
⑫	Extends/retracts the seat belt extender	→	36	㉙	Control panel for:		
⑬	Opens and closes the soft top	→	76		Active Steering Assist	→	168
⑭	Activates and deactivates AIRCAP	→	79		Active Lane Keeping Assist	→	197
⑮	Stowage compartment	→	100		Parking Assist PARKTRONIC	→	177
⑯	Opens and closes the side windows	→	71		Head-up Display	→	211
⑰	ECO start/stop function	→	137				









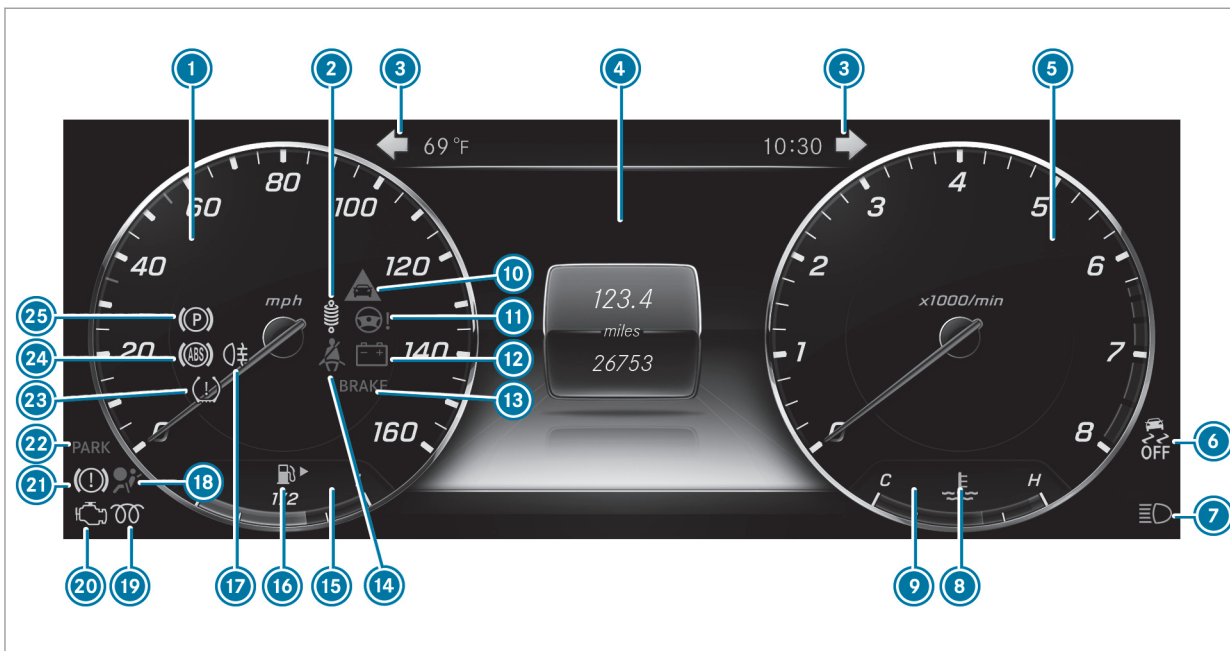



Instrument Display (standard)

①	Speedometer	→	199	⑬	 Distance warning	→	453
②	 ESP®	→	446	⑭	 Coolant too hot/cold	→	455
③	  Turn signal light	→	112	⑮	Coolant temperature display	→	199
④	 Power assisted steering malfunction	→	454	⑯	 Brakes (yellow)	→	446
⑤	Multifunction display	→	202	⑰	 Electric parking brake (yellow)	→	446
⑥	 ABS malfunction	→	446	⑱	 Restraint system		
⑦	 Check Engine	→	455	⑲	 Seat belt not fastened	→	453
⑧	Tachometer	→	199	⑳	 Parking lights	→	111
⑨	 This indicator lamp has no function			㉑	Fuel level indicator		
⑩	 Electric parking brake applied (red)	→	446		 Fuel reserve with fuel filler flap location indicator	→	455
	 USA only			㉒	 High beam	→	112
	 Canada only			㉓	 Low beam	→	111
⑪	 Brakes (red)	→	446	㉔	 Rear fog light	→	112
	 USA only			㉕	AIR BODY CONTROL malfunctioning	→	453
	 Canada only			㉖	 Tire pressure monitoring system	→	459
⑫	 Electrical fault	→	455	㉗	 ESP® OFF	→	446

10 At a glance - Warning and indicator lamps















Instrument Display in the Widescreen Cockpit

①	Speedometer	→	199
②	AIR BODY CONTROL malfunctioning	→	453
③	 Turn signal light	→	112
④	Multifunction display	→	202
⑤	Tachometer	→	199
⑥	 ESP® OFF	→	446
	 ESP®	→	446
⑦	 High beam	→	112
	 Low beam	→	111
	 Parking lights	→	111
⑧	 Coolant too hot/cold	→	455
⑨	Coolant temperature display	→	199
⑩	 Distance warning	→	453
⑪	 Power assisted steering malfunction	→	454
⑫	 Electrical fault	→	455
⑬	Brakes (red)	→	446





 USA only

 Canada only

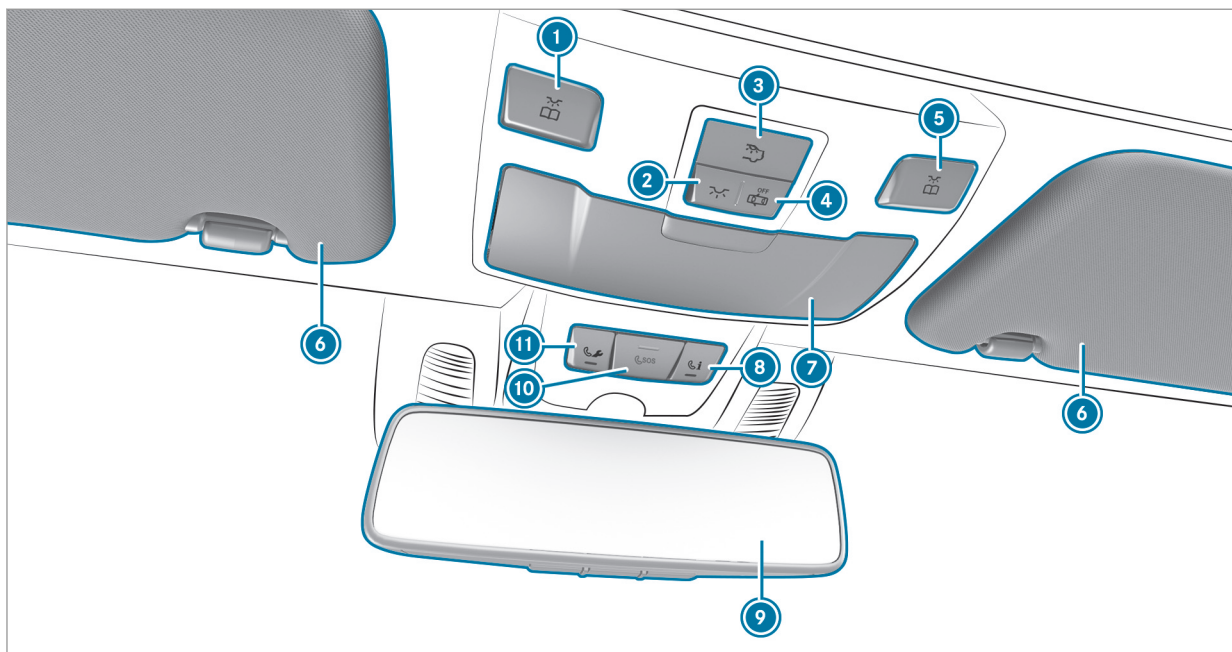
⑭	 Seat belt not fastened	→	453
⑮	Fuel level indicator		
⑯	 Fuel reserve with fuel filler flap location indicator	→	455
⑰	 Rear fog light	→	112
⑱	 Restraint system		
⑲	 Indicator lamp has no function		
⑳	 Check Engine	→	455
㉑	 Brakes (yellow)	→	446
㉒	Electric parking brake applied (red)	→	446
	 USA only		
	 Canada only		
㉓	 Tire pressure monitoring system	→	459
㉔	 ABS malfunction	→	446
㉕	 Electric parking brake (yellow)	→	446

## 12 At a glance - Overhead control panel







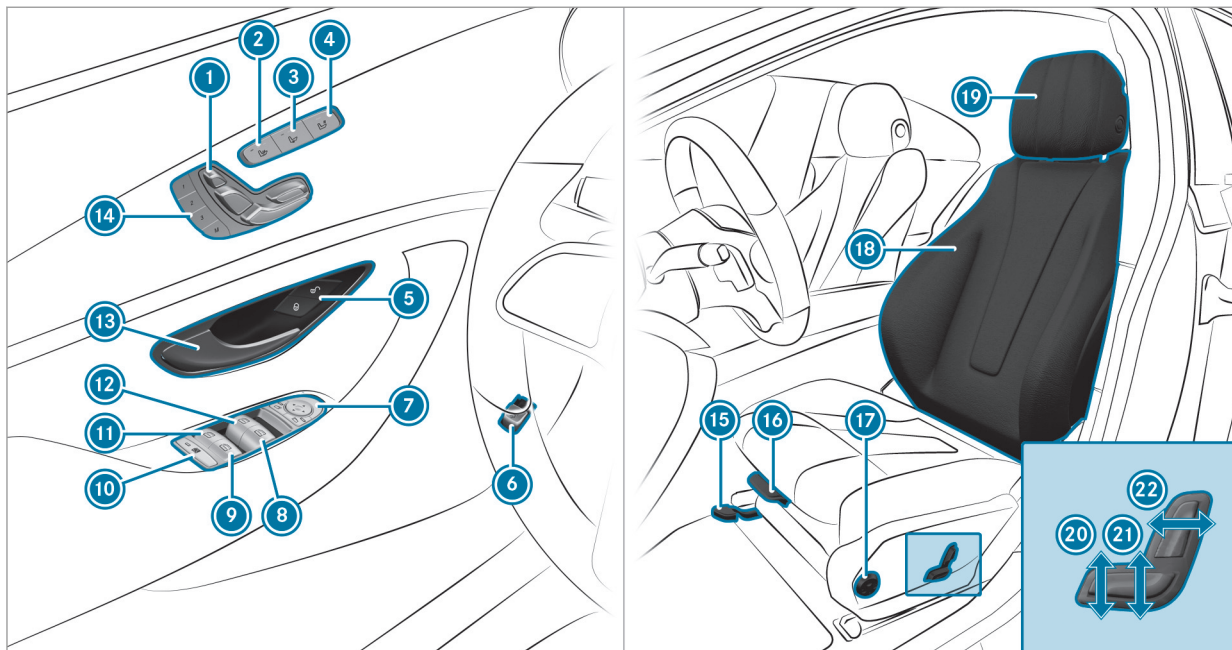

①		Switches the left-hand reading lamp on/off	→	115
②		Switches the front interior lighting on/off	→	115
③		Switches the rear interior lighting on/off	→	115
④		Switches automatic lighting control on/off	→	115
⑤		Switches the right-hand reading lamp on/off	→	115

⑥	Sun visors	→	123
⑦	Eyeglasses compartment	→	101
⑧	MB Info call button (mbrace®)	→	284
⑨	Inside rearview mirror	→	121
⑩	SOS button (mbrace®)	→	283
⑪	Roadside assistance call button (mbrace®)	→	284

14 At a glance - Door control panel and seat adjustment





①	Adjusts the seats electrically	→	88	⑫	 Opens/closes the left side window	→	71
②	Switches the seat heating on/off	→	92	⑬	Opens the door	→	62
③	Switches the seat ventilation on/off	→	94	⑭	Sets the memory function	→	98
④	Switches AIRSCARF on/off	→	94	⑮	Sets the seat fore-and-aft position	→	86
⑤	  Locks/unlocks the vehicle	→	62	⑯	Adjusts the seat cushion length	→	86
⑥	Opens/closes the trunk lid	→	65	⑰	Adjusts the 4-way lumbar support	→	89
⑦	Adjusts and folds the outside mirrors out/in electrically	→	120	⑱	Seat adjustment using the multimedia system	→	91
⑧	 Opens/closes the right side window	→	71	⑲	Adjusts the head restraints	→	89
⑨	 Opens/closes the rear right side window	→	71	⑳	Adjusts the seat cushion inclination	→	86
⑩	Child safety lock for the rear side windows	→	55	㉑	Adjusts the seat height	→	86
⑪	 Opens/closes the rear left side window	→	71	㉒	Sets the seat backrest inclination	→	86

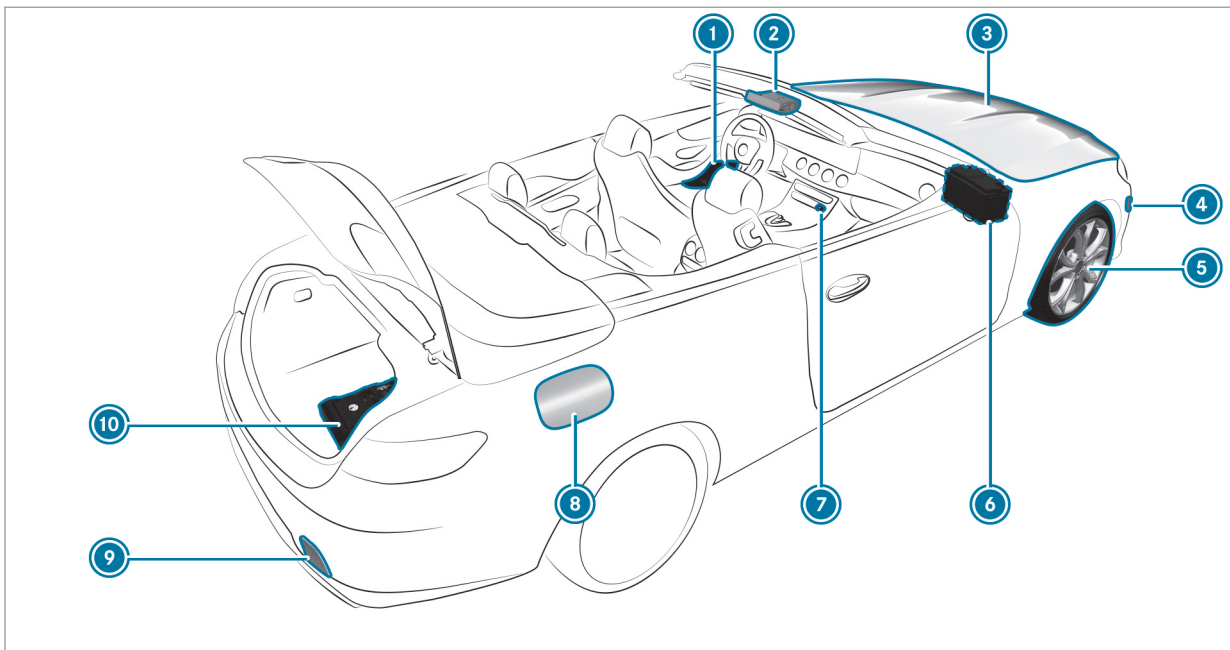

What to do in the event of an accident			
①	Safety vests	→	332
②	Buttons for the SOS emergency call system and breakdown assistance	→	282
③	Checking and topping up operating fluids	→	387
④	Tow-starting and towing away	→	344
⑤	Flat tire	→	332
⑥	Starting assistance	→	340
⑦	Hazard warning lights	→	113
⑧	Fuel filler flap with instruction labels for tire pressure, fuel type and QR code for accessing the rescue card	→	143
⑨	Tow-starting and towing away	→	344
⑩	TIREFIT kit	→	334

## Calling up the Digital Operator's Manual

Multimedia system:

→ Vehicle → ⓘ Operator's Manual



▶ Select a menu item.

In addition, you can also call up the Operator's Manual within a main function (e.g. via [Info on Phone](#)).

The Digital Operator's Manual describes the function and operation of:

- The vehicle
- The multimedia system

For safety reasons, the Digital Operator's Manual is deactivated while driving.

The Digital Operator's Manual contains the following menu items:

- **Search:** allows you to search precisely for keywords.
- **Quick start:** provides you with important information so that you can start using your vehicle immediately.
- **Tips:** provides tips on how to use your vehicle in certain situations.
- **Bookmarks:** provides you with a list of all the bookmarks you have stored yourself.

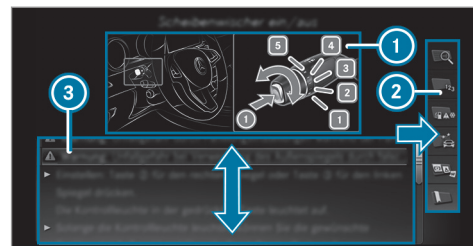

- ① Picture
- ② Menu
- ③ Navigation window

Some sections of the Digital Operator's Manual, e.g. warnings, can be made visible by highlighting and pressing them.

- ⓘ The Operator's Manual can also be found in the Mercedes-Benz Guides app in all common app stores.

## Protecting the environment

 **ENVIRONMENTAL NOTE** Environmental damage due to operating conditions and personal driving style

The pollutant emission of your vehicle is directly related to the way you operate your vehicle.

You can help to protect the environment by operating your vehicle in an environmentally responsible manner. Please observe the following recommendations on operating conditions and personal driving style.

### Operating conditions:

- ▶ Make sure that the tire pressure is correct.
- ▶ Do not carry any unnecessary weight (e.g. roof luggage racks once you no longer need them).
- ▶ Adhere to the service intervals. A regularly serviced vehicle will contribute to environmental protection.

- ▶ Always have service work carried out at a qualified specialist workshop.

### Personal driving style:

- ▶ Do not depress the accelerator pedal when starting the engine.
- ▶ Do not warm up the engine while the vehicle is stationary.
- ▶ Drive carefully and maintain a suitable distance from the vehicle in front.
- ▶ Avoid frequent, sudden acceleration and braking.
- ▶ Change gear in good time and use each gear only up to  $\frac{2}{3}$  of its maximum engine speed.
- ▶ Switch off the engine in stationary traffic, e.g. by using the ECO start/stop function.
- ▶ Drive in a fuel-efficient manner.

### Environmental issues and recommendations:

It is recommended that you re-use or recycle materials instead of just disposing of them.

The relevant environmental guidelines and regulations serve to protect the environment and must be strictly observed.

## Mercedes-Benz GenuineParts

 **ENVIRONMENTAL NOTE** Environmental damage caused by not using recycled/reconditioned components

Daimler AG offers recycled/reconditioned components and parts with the same quality as new parts. The same entitlement from the Limited Warranty is valid as for new parts.

- ▶ Use recycled/reconditioned components and parts from Daimler AG.

**!** **NOTE** Impairment of the operating efficiency of the restraint systems from installing accessories or from repairs or welding

Airbags, Emergency Tensioning Devices, as well as control units and sensors for the restraint systems, may be installed in the following areas of your vehicle:

- Doors
- Door pillars
- Door sills
- Seats
- Cockpit
- Instrument cluster
- Center console

- ▶ Do not install accessories such as audio systems in these areas.
- ▶ Do not carry out repairs or welding.
- ▶ Have accessories retrofitted at a qualified specialist workshop.

You could jeopardize the operating safety of your vehicle if you use parts, tires and wheels as well as accessories relevant to safety which have not been approved by Mercedes-Benz. Safety-relevant systems, e.g. the brake system, may malfunction. Only use Mercedes-Benz GenuineParts or parts of equal quality. Only use tires, wheels and accessory parts that have been specifically approved for your vehicle model.

Mercedes-Benz GenuineParts are subject to strict quality control. Each part has been specially developed, manufactured or selected for Mercedes-Benz vehicles and fine-tuned for them. Therefore, only Mercedes-Benz GenuineParts should be used.

More than 300,000 different Mercedes-Benz GenuineParts are available for Mercedes-Benz models.

All authorized Mercedes-Benz Centers maintain a supply of Mercedes-Benz GenuineParts for necessary service and repair work. In addition, strategically located parts-delivery centers provide for quick and reliable parts service.

Always specify the vehicle identification number (VIN) (→ page 385) when ordering Mercedes-Benz GenuineParts.

### Operator's Manual

This Operator's Manual describes all models and all standard and optional equipment available for your vehicle at the time of this Operator's Manual going to press. Country-specific differences are possible. Note that your vehicle may not be equipped with all features described. This also applies to safety-relevant systems and functions. Therefore, the equipment on your vehicle may differ from that in the descriptions and illustrations.

The original purchase contract documentation for your vehicle contains a list of all of the systems in your vehicle.

Should you have any questions concerning equipment and operation, please consult an authorized Mercedes-Benz Center.

The Operator's Manual and Maintenance Booklet are important documents and should be kept in the vehicle.

## Service and vehicle operation

### Vehicle operation outside the USA or Canada

When you are abroad with your vehicle, observe the following points:

- Service points or replacement parts may not be available immediately.
- Unleaded fuel may not be available for vehicles with a catalytic converter. Leaded fuel may cause damage to the catalytic converter.
- The fuel may have an extremely low octane number. Unsuitable fuel can cause engine damage.

Some Mercedes-Benz models are available in Europe through our European Delivery Program. For more information, please consult an authorized Mercedes-Benz service center, or write to one of the following address:

#### **In the USA:**

Mercedes-Benz USA, LLC  
European Delivery Department  
One Mercedes Drive  
Montvale, NJ 07645-0350

#### **In Canada:**

Mercedes-Benz Canada, Inc.  
European Delivery Department  
98 Vanderhoof Avenue  
Toronto, Ontario M4G 4C9

### Maintenance

Your customer advisor confirms the service in the service report.

### Roadside Assistance

The Mercedes-Benz Roadside Assistance Program offers technical help in the case of a breakdown. Your calls to the toll-free Roadside Assistance Hotline are answered by our agents 24 hours a day, 365 days a year.

1-800-FOR-MERCEdes (1-800-367-6372) (USA)  
1-800-387-0100 (Canada)

You can find further information in the Mercedes-Benz Roadside Assistance Program brochure (USA) or the "Roadside Assistance"

section in the maintenance and warranty information booklet (Canada). You will find both in the vehicle document wallet.

### Change of address or change of ownership

In the event of a change of address, please send us the "Notification of address change" in the Service and Guarantee booklet or simply call the Mercedes-Benz Customer Assistance Center (USA) on the hotline number 1-800-FOR-MERCEdes (1-800-367-6372) or Customer Service (Canada) on 1-800-387-0100. We can then reach you in a timely fashion, if necessary.

If you sell your Mercedes, please leave all literature in the vehicle so that it is available to the next owner. If you have purchased a used vehicle, please send us the "Notice of Purchase of Used Car" in the Service and Guarantee booklet or simply call the Mercedes-Benz Customer Assistance Center (USA) at the hotline number 1-800-FOR-MERCEdes (1-800-367-6372) or Customer Service (Canada) at 1-800-387-0100.

### **Important notice for California retail buyers and lessees of Mercedes-Benz automobiles**

Under California law you may be entitled to a replacement of your vehicle or a refund of the purchase price or lease price, if after a reasonable number of repair attempts Mercedes-Benz USA, LLC and/or its authorized repair or service facilities fail to fix one or more substantial defects or malfunctions in the vehicle that are covered by its express warranty.

During a period of 18 months from original delivery of the vehicle or a kilometer/mileage reading of 18,000 miles (29,000 km), whichever occurs first, vehicle repair is presumed for a retail buyer or lessee if one or more of the following occurs:

- (1) the serious defect or damage can result in deadly or serious injury to the vehicle occupants while driving AND this defect has already been repaired at least twice AND Mercedes-Benz, LLC has been informed in writing of the necessity of a repair.
- (2) the defect or damage, though less serious than (1) above, has already been repaired at

least four times AND Mercedes-Benz has been informed in writing of the necessity of a repair.

- (3) the vehicle cannot be used for longer than 30 calendar days because of repair work resulting from this or other serious defects or damage.

Please send your written notice to:

Mercedes-Benz USA, LLC  
Customer Assistance Center  
3 Mercedes Drive  
Montvale, NJ 07645-0350

### **Operating safety**

**⚠ WARNING** Risk of accident due to malfunctions or system failures

If you do not have the prescribed service/maintenance work or any required repairs carried out, this could result in malfunctions or system failures.

- ▶ Always have the prescribed service/maintenance work as well any required repairs carried out at a qualified specialist workshop.

**⚠ WARNING** Risk of accident or injury due to incorrect modification of electronic components and parts

Modification to electronic components, their software or wiring could impair their function and/or the function of other networked component parts. In particular, systems relevant to safety could also be affected.

As a result, these may no longer function properly and/or jeopardize the operating safety of the vehicle.

- ▶ Never tamper with the vehicle's wiring, electronic components or software.
- ▶ You should have all work on electrical and electronic components carried out at a qualified specialist workshop.



**⚠ WARNING** Risk of fire due to flammable materials on hot parts of the exhaust system

Flammable material such as leaves, grass or twigs may ignite if they come into contact with hot parts of the exhaust system.

- ▶ When driving on unpaved roads or off-road, regularly check the vehicle underside.
- ▶ Remove trapped plants or other flammable material.
- ▶ If there is damage, consult a qualified specialist workshop immediately.

**! NOTE** Damage to the vehicle

Damage to the vehicle may occur in the following cases:

- the vehicle becomes grounded, e.g. on a high curb or an unpaved road.

- the vehicle is driven too fast over an obstacle, e.g. a curb, speed bump or pothole.
- a heavy object strikes the underbody or chassis components.

In situations such as this, the body, the underbody, chassis components, wheels or tires could be damaged without the damage being visible. Components damaged in this way can unexpectedly fail or, in the case of an accident, no longer withstand the strain they are designed to.

If the underbody paneling is damaged, flammable materials such as leaves, grass or twigs can gather between the underbody and the underbody paneling. These materials may ignite if they come into contact with hot parts on the exhaust system.

- ▶ Have the vehicle checked and repaired immediately at a qualified specialist workshop.

or

- ▶ If driving safety is impaired while continuing your journey, pull over and stop the vehicle immediately, paying attention to road and traffic conditions, and contact a qualified specialist workshop.

**Declaration of conformity for wireless vehicle components**

**USA:** "The wireless devices of this vehicle comply with Part 15 of the FCC Rules. Operation is subject to the following two conditions: 1) These devices may not cause harmful interference, and 2) These devices must accept any interference received, including interference that may cause undesired operation. Changes or modifications not expressly approved by the party responsible for compliance could void the user's authority to operate the equipment."

**Canada:** "The wireless devices of this vehicle comply with Industry Canada license-exempt RSS standard(s). Operation is subject to the following two conditions: (1) These devices may not cause interference, and (2) These devices

must accept any interference, including interference that may cause undesired operation of the device."

**USA:** "Wireless charging system for mobile devices (Model: D-WMI2015A): this device complies with Part 18 of the FCC Rules."

The name and address of the responsible party is:

Continental Automotive Systems US Inc.  
2400 Executive Hills Drive  
Auburn Hills, MI 48326-2980  
United States of America

### Diagnostics connection

The diagnostics connection is only intended for the connection of diagnostic devices at a qualified specialist workshop.

**⚠ WARNING** Risk of accident due to connecting devices to the diagnostics connection

If you connect equipment to a diagnostics connection in the vehicle, it may affect the operation of vehicle systems.

As a result, the operating safety of the vehicle could be affected.

- ▶ Only connect equipment to a diagnostics connection in the vehicle which is approved for your vehicle by Mercedes-Benz.

**⚠ WARNING** Risk of accident due to objects in the driver's footwell

Objects in the driver's footwell may impede pedal travel or block a depressed pedal.

This jeopardizes the operating and road safety of the vehicle.

- ▶ Stow all objects in the vehicle securely so that they cannot get into the driver's footwell.

- ▶ Always install the floor mats securely and as prescribed in order to ensure that there is always sufficient room for the pedals.
- ▶ Do not use loose floor mats and do not place floor mats on top of one another.

**! NOTE** Battery discharging from using devices connected to the diagnostics connection

Using devices at the diagnostics connection drains the battery.

- ▶ Check the charge level of the battery.
- ▶ If the charge level is low, charge the battery, e.g. by driving a considerable distance.

Connecting equipment to the diagnostics connection can lead to emissions monitoring information being reset, for example. This may lead to the vehicle failing to meet the requirements of the next emissions inspection during the main inspection.

### Qualified specialist workshop

An authorized Mercedes-Benz Center is a qualified specialist workshop. It has the necessary specialist knowledge, tools and qualifications to correctly carry out the work required on your vehicle. This particularly applies to work relevant to safety.

Always have the following work carried out on your vehicle at a qualified specialist workshop:

- work relevant to safety
- service and maintenance work
- repair work
- modifications as well as installations and conversions
- work on electronic component parts

Mercedes-Benz recommends an authorized Mercedes-Benz Center.

### Correct use of the vehicle

If you remove any warning stickers, you or others could fail to recognize certain dangers. Leave warning stickers in position.

When using the vehicle, observe the following information:

- the safety notes in this manual
- technical data for the vehicle
- traffic rules and regulations
- laws and safety standards pertaining to motor vehicles

### Problems with your vehicle

If you should experience a problem with your vehicle, particularly one that you believe may affect its safe operation, we urge you to contact an authorized Mercedes-Benz service center immediately to have the problem diagnosed and rectified. If the problem is not resolved to your satisfaction, please discuss the problem again with the authorized Mercedes-Benz service center or, if necessary, contact us at one of the following addresses.

#### In the USA:

Customer Assistance Center  
Mercedes-Benz USA, LLC

3 Mercedes Drive  
Montvale, NJ 07645-0350

#### In Canada:

Customer Relations Department  
Mercedes-Benz Canada, Inc.  
98 Vanderhoof Avenue  
Toronto, Ontario M4G 4C9

### Reporting safety defects

#### USA only:

The following text is published as required of manufacturers under Title 49, Code of U.S. Federal Regulations, Part 575 pursuant to the "National Traffic and Motor Vehicle Safety Act of 1966".

If you believe that your vehicle has a defect which could cause a crash or could cause injury or death, you should immediately inform the National Highway Traffic Safety Administration (NHTSA) in addition to notifying Mercedes-Benz USA, LLC.

If NHTSA receives similar complaints, it may open an investigation, and if it finds that a safety defect exists in a group of vehicles, it may order a recall and remedy campaign. However, NHTSA cannot become involved in individual problems between you, your dealer, or Mercedes-Benz USA, LLC.

To contact NHTSA, you may call the Vehicle Safety Hotline toll-free at 1-888-327-4236 (TTY: 1-800-424-9153) (inside the USA); go to <http://www.safercar.gov>; or write to: Administrator, NHTSA, 400 Seventh Street, SW., Washington, DC 20590, USA.

Further information on vehicle safety can be found at: <http://www.safercar.gov>

### Limited Warranty

**!** **NOTE** Damage to the vehicle arising from violation of these operating instructions.

Damage to the vehicle can arise from violation of these operating instructions.

This damage is not covered either by the Mercedes-Benz implied warranty or by the New- or Used-Vehicle Warranty.

▶ Follow the instructions in these operating instructions on proper operation of your vehicle as well as on possible vehicle damage.

### QR codes for the rescue card

The QR code is secured in the fuel filler flap and on the opposite side on the B-pillar. In the event of an accident, rescue services can use the QR code to quickly find the appropriate rescue card for your vehicle. The current rescue card contains the most important information about your vehicle in a compact form, e.g. the routing of the electric lines.

Further information can be obtained at <http://www.mercedes-benz.de/qrcode>.

### Vehicle data storage

#### Information from electronic control units

Your vehicle is equipped with electronic control units. Some of these are necessary for the safe operation of your vehicle, while some assist you when driving (driver assistance systems). In addition, your vehicle provides convenience and entertainment functions, which are also made possible by electronic control units.

Electronic control units contain data memories which can temporarily or permanently store technical information about the vehicle's operating status, component loads, maintenance requirements and technical events or malfunctions.

In general, this information documents the state of a component part, a module, a system or the surroundings, for example:

- operating statuses of system components (e.g. fluid levels, battery status, tire pressure)
- status messages concerning the vehicle and its individual components (e.g. number of wheel revolutions/speed, deceleration, lat-

eral acceleration, display of the fastened seat belts)

- malfunctions or defects in important system components (e.g. lights, brakes)
- information on vehicle damage events
- system reactions in special driving situations (e.g. air bag deployment, intervention of stability control systems)
- ambient conditions (e.g. temperature, rain sensor)

In addition to providing the actual control unit function, this data assists the manufacturer in detecting and rectifying malfunctions and optimizing vehicle functions. The majority of this data is temporary and is only processed in the vehicle itself. Only a small portion of the data is stored in the event or malfunction memory.

When your vehicle is serviced, technical data from the vehicle can be read out by service network employees or third parties. Services include repair services, maintenance processes, warranty events and quality assurance measures, for example. The read out is performed via the legally prescribed port for OBD ("on-board

diagnostics") in the vehicle. The respective service network locations or third parties collect, process and use the data. They document technical statuses of the vehicle, assist in finding malfunctions and improving quality and are transmitted to the manufacturer, if necessary. Furthermore, the manufacturer is subject to product liability. For this, the manufacturer requires technical data from vehicles.

Malfunction memories in the vehicle can be reset by a service outlet as part of repair or maintenance work.

They can enter data into the vehicle's convenience and infotainment functions themselves as part of the selected equipment.

This includes, for example:

- multimedia data such as music, films or photos for playback in an integrated multimedia system
- address book data for use in connection with an integrated hands-free system or an integrated navigation system
- entered navigation destinations
- data about the use of Internet services

This data can be stored locally in the vehicle or is located on a device which you have connected to the vehicle. If this data is stored in the vehicle, you can delete it at any time. This data can only be transmitted to third parties upon your request with particular regard to the scope of use of online services according to your selected settings.

You can store or change convenience settings/individualization in the vehicle at any time.

Depending on the equipment, this includes, for example:

- seat and steering wheel position settings
- suspension and climate control settings
- individualization such as interior lighting

If your vehicle is accordingly equipped, you can connect your smartphone or another mobile end device to the vehicle. You can control them via the control elements integrated in your vehicle. Images and audio from the smartphone can be output via the multimedia system. Certain information is simultaneously transmitted to your smartphone.

Depending on the respective integration type, this includes, for example:

- general vehicle information
- position data

This enables the use of selected smartphone Apps, e.g. navigation or music playback. There is no further interaction between the smartphone and the vehicle; in particular, vehicle data is not directly accessible. The type of further data processing is determined by the provider of the App used. The respective App and your smartphone's operating system determine whether changes can be made to the settings and which settings can be changed.

### **Service providers**

---

#### **Wireless network connection**

If your vehicle has a wireless network connection, it enables data to be exchanged between your vehicle and additional systems. The wireless network connection is enabled via the vehicle's transmission and reception unit or via connected mobile end devices (e.g. smartphones).

Online functions can be used via the wireless network connection. This includes online services and applications/Apps provided by the manufacturer or other providers.

#### **Manufacturer's services**

The manufacturer describes the respective functions and corresponding legal data protection information when suitable for the manufacturer's online services. Personal data may be used for the provision of online services. Data is exchanged via a secure connection, e.g. to the manufacturer's designated IT systems. Personal data is collected, processed and used via the provision of services exclusively on the basis of legal permissions or with prior consent.

The services and functions (sometimes subject to a fee) can usually be activated or deactivated. In some cases, this also applies to the entire vehicle's data connection. This excludes, in particular, legally prescribed functions and services.

#### **Third party services**

If it is possible to use online services from other providers, these services are subject to the data protection and terms of use of the responsible

provider. The manufacturer has no influence on the content exchanged.

Please enquire, therefore, about the type, scope and purpose of the collection and use of personal data as part of third party services from their respective provider.

### **COMAND/mbrace**

---

If the vehicle is equipped with COMAND or mbrace, additional data about the vehicle's operation, the use of the vehicle in certain situations, and the location of the vehicle may be compiled through COMAND or the mbrace system.

For additional information please refer to the chapter Multimedia system and/or the mbrace Terms and Conditions.

### **Event Data Recorders**

---

This vehicle is equipped with an event data recorder (EDR). The main purpose of an EDR is to record, in certain crash or near crash-like situations, such as an air bag deployment or hitting a road obstacle, data that will assist in under-

standing how a vehicle's systems performed. The EDR is designed to record data related to vehicle dynamics and safety systems for a short period of time, typically 30 seconds or less. The EDR in this vehicle is designed to record such data as:

- How various systems in your vehicle were operating
- Whether or not the driver and front passenger seat belts were buckled/fastened
- How far (if at all) the driver was depressing the accelerator and/or brake pedal and
- How fast the vehicle was traveling.

This data can help provide a better understanding of the circumstances in which accidents and injuries occur. NOTE: EDR data is recorded by your vehicle only if a non-trivial crash situation occurs; no data is recorded by the EDR under normal driving conditions and no personal data (e.g. name, gender, age and crash location) is recorded. However, other parties, such as law enforcement, could combine the EDR data with the type of personally identifying data routinely acquired during a crash investigation.

Access to the vehicle and/or the EDR is needed to read data that is recorded by an EDR, and special equipment is required. In addition to the vehicle manufacturer, other parties that have the special equipment, such as law enforcement, can read the information by accessing the vehicle or the EDR.

EDR data may be used in civil and criminal matters as a tool in accident reconstruction, accident claims and vehicle safety. Since the Crash Data Retrieval (CDR) tool that is used to extract data from the EDR is commercially available, Mercedes-Benz USA, LLC ("MBUSA") expressly disclaims any and all liability arising from the extraction of this information by unauthorized Mercedes-Benz personnel.

MBUSA will not share EDR data with others without the consent of the vehicle owner or, if the vehicle is leased, without the consent of the lessee. Exceptions to this representation include responses to subpoenas by law enforcement; by federal, state or local government; in connection with or arising out of litigation involving MBUSA or its subsidiaries and affiliates; or, as required by law.

Warning: the EDR is a component of the Restraint System Module. Tampering with, altering, modifying or removing the EDR component may result in a malfunction of the Restraint System Module and other systems.

State laws or regulations regarding EDRs that conflict with federal regulation are pre-empted. This means that in the event of such conflict, the federal regulation governs. As of February 2013, 13 states have enacted laws relating to EDRs.

### Copyright

#### Free and open source software

Information on free and open source software licenses for your vehicle's software can be found on the data storage medium in your vehicle document wallet and on the Internet together with updates:

<http://www.mercedes-benz.com/opensource>

### Registered trademarks

- Bluetooth® is a registered trademark of Bluetooth SIG Inc.
- DTS™ is a registered trademark of DTS, Inc.
- Dolby® and MLP™ are registered trademarks of DOLBY Laboratories.
- BabySmart™, ESP® and PRE-SAFE® are registered trademarks of Daimler AG.
- HomeLink® is a registered trademark of Johnson Controls.
- iPod® and iTunes® are registered trademarks of Apple Inc.
- Burmester® is a registered trademark of Burmester Audiosysteme GmbH.
- Microsoft® and Windows Media® are registered trademarks of Microsoft Corporation.
- SIRIUS® is a registered trademark of Sirius XM Radio Inc.
- HD Radio™ is a registered trademark of iBiquity Digital Corporation.
- Gracenote® is a registered trademark of Gracenote, Inc.
- ZAGATSurvey® and related brands are registered trademarks of ZagatSurvey, LLC.



## Restraint system

### Protection by the restraint system

The restraint system includes the following:

- Seat belt system
- Air bags
- Child restraint system
- Child seat securing system

The restraint system can reduce the risk of vehicle occupants coming into contact with parts of the vehicle interior in the event of an accident. In the event of an accident, the restraint system can also reduce the forces to which the vehicle occupants are subjected.

A seat belt can only provide the best level of protection if it is worn correctly. Depending on the detected accident situation, Emergency Tensioning Devices and/or air bags supplement the protection offered by a correctly worn seat belt. Emergency Tensioning Devices and/or air bags are not deployed in every accident.

In order for the restraint system to provide the intended level of protection, each vehicle occupant must observe the following information:

- Fasten seat belts correctly.
- Sit in an almost upright seat position with their back against the seat backrest.
- Sit with their feet resting on the floor, if possible.
- Always secure persons under 5 ft (1.50 m) tall in an additional restraint system suitable for Mercedes-Benz vehicles.

However, no system available today can completely eliminate injuries and fatalities in every accident situation. In particular, the seat belt and air bag generally do not protect against objects penetrating the vehicle from the outside. It is also not possible to completely rule out the risk of injury caused by the air bag deploying.

### Reduced restraint system protection

**▲ WARNING** Risk of injury or death from modifications to the restraint system

The restraint system can no longer function correctly after alterations have been made.

The restraint system may then not protect the vehicle occupants as intended by failing in an accident or triggering unexpectedly, for example

- ▶ Never alter the parts of the restraint system.
- ▶ Never tamper with the wiring or any electronic component parts or their software.



- If it is necessary to modify the vehicle to accommodate a person with disabilities, contact an authorized Mercedes-Benz Center for details.
- USA only: for details, contact our Customer Assistance Center on 1-800-FOR-MERCEDES (1-800-367-6372).

### Restraint system functionality

When the ignition is switched on, a system self-test is performed, during which the  restraint system warning lamp lights up. It goes out no later than a few seconds after the vehicle is started. The components of the restraint system are then functional.

### Malfunctioning restraint system

A malfunction has occurred in the restraint system if:

- The  restraint system warning lamp does not light up when the ignition is switched on.
- The  restraint system warning lamp lights up continuously or repeatedly during a journey.

**⚠ WARNING** Risk of injury or fatal injury due to a malfunction in the restraint system

If the restraint system is malfunctioning, restraint system components may be triggered unintentionally or might not be triggered at all in the event of an accident. This may affect the Emergency Tensioning Device or airbag, for example.

- ▶ Have the restraint system checked and repaired immediately at a qualified specialist workshop.

### Function of the restraint system in an accident

How the restraint system works is determined by the severity of the impact detected and the type of accident anticipated:

- Frontal impact
- Rear impact
- Side impact
- Rollover

The activation thresholds for the components of the restraint system are determined based on the evaluation of the sensor values measured at various points in the vehicle. This process is pre-emptive in nature. The triggering/deployment of the components of the restraint system should take place in good time at the start of the collision.

Factors which can only be seen and measured after a collision has occurred cannot play a decisive role in air bag deployment, nor do they provide an indication of air bag deployment.

The vehicle may be deformed significantly without an air bag being deployed. This is the case if only parts which are relatively easily deformed are affected and the rate of vehicle deceleration is not high. Conversely, an air bag may be deployed even though the vehicle suffers only minor deformation. If very rigid vehicle parts such as longitudinal members are hit, for example, the vehicle deceleration may be high enough for this to happen.

The components of the restraint system can be activated or deployed independently of each other:

Component	Detected deployment situation
Emergency Tensioning Devices	Frontal impact, rear impact, side impact, rollover
Driver's air bag, front passenger air bag	Frontal impact
Knee air bag	Frontal impact
Side air bag	Side impact
Head air bag	Side impact, rollover, frontal impact

The front-passenger air bag can be deployed in an accident only if the PASSENGER AIR BAG OFF indicator lamp is off. If the front passenger seat is occupied, make sure, both before and during the journey, that the status of the front passenger air bag is correct (→ page 43).

**⚠ WARNING** Risk of burns from hot air bag components

The air bag parts are hot after an air bag has been deployed.

- ▶ Do not touch the air bag parts.
- ▶ Have a deployed air bag replaced at a qualified specialist workshop as soon as possible.

Mercedes-Benz recommends that you have the vehicle towed to a qualified specialist workshop after an accident. Take this into account, particularly if an Emergency Tensioning Device is triggered or an air bag is deployed.

If the Emergency Tensioning Devices are triggered or an air bag is deployed, you will hear a bang, and powder may also be released:

- The bang will not generally affect your hearing.
- In general, the powder released is not hazardous to health but may cause short-term breathing difficulties to persons suffering from asthma or other pulmonary conditions.

Provided it is safe to do so, leave the vehicle immediately or open the window in order to prevent breathing difficulties.

Air bags and pyrotechnic Emergency Tensioning Devices contain perchlorate material, which may require special handling or environmental protection measures. National guidelines must be observed during disposal. In California, see <http://www.dtsc.ca.gov/HazardousWaste/Perchlorate/index.cfm>.

## Seat belts

### Protection provided by the seat belt

Always fasten your seat belt correctly before starting a journey. A seat belt can only provide the best level of protection if it is worn correctly.

**⚠ WARNING** Risk of injury or death due to incorrectly fastened seat belt

If the seat belt is not worn correctly, it cannot perform its intended protective function.

In addition, an incorrectly fastened seat belt can also cause injuries, for example, in the event of an accident or when braking or changing direction suddenly.

- ▶ Always ensure that all vehicle occupants have their seat belts fastened correctly and are sitting properly.

In order for the correctly worn seat belt to provide the intended level of protection, each vehicle occupant must observe the following information:

- The seat belt must not be twisted and must fit tightly and snugly across the body.
- The seat belt must be routed across the center of the shoulder and as low down across the hips as possible.
- The shoulder section of the seat belt should not touch your neck nor be routed under your arm or behind your back.
- Avoid wearing bulky clothing, e.g. a winter coat.
- Push the lap belt down as far as possible across your hips and pull tight with the shoulder

section of the belt. Never route the lap belt across your abdomen.

- Never route the seat belt across sharp, pointed, abrasive or fragile objects.
- Only one person should use each seat belt at any one time. Never allow babies and children to travel sitting on the lap of another vehicle occupant.
- Never secure objects with a seat belt if the seat belt is also being used by one of the vehicle's occupants. Always observe the instructions for loading the vehicle when securing objects, luggage or loads (→ page 99).

Also ensure that no objects, e.g. a cushion, are ever placed between a person and the seat.

The seat belts on the following seats are equipped with a child seat safety feature:

- Front passenger seat
- Rear seats

Activate or deactivate the child seat safety feature of the seat belt (→ page 50).

If children are traveling in the vehicle, be sure to observe the instructions and safety notes on "Children in the vehicle" (→ page 47).

### Reduced seat belt protection

**⚠ WARNING** Risk of injury or death due to incorrect seat position

The seat belt does not offer the intended level of protection if you have not moved the seat backrest to an almost vertical position.

When braking or in the event of an accident, you could slide underneath the seat belt and sustain abdominal or neck injuries, for example.

- ▶ Adjust the seat properly before beginning your journey.
- ▶ Always ensure that the seat backrest is in an almost vertical position and that the shoulder section of your seat belt is routed across the center of your shoulder.

**▲ WARNING** Risk of injury or death due to an extended seat belt extender while the vehicle is in motion

If the seat belt extender is extended while the vehicle is in motion, the seat belt will not fit correctly to the body.

The seat belt may not then provide the proper protection.

- ▶ Always ensure that the seat belt extender is retracted while the vehicle is in motion.

If the seat belt extender does not retract automatically, it can be retracted manually. To do so, press the seat belt extender back as far as it will go before starting the vehicle. Pressing the seat belt extender back into place requires force.

**▲ WARNING** Risk of injury or death when additional restraint systems are not used for persons with a smaller build

Persons under 5 ft (1.50 m) tall cannot wear the seat belt correctly without a suitable additional restraint system.

If the seat belt is not worn correctly, it cannot perform its intended protective function. In addition, an incorrectly fastened seat belt can also cause injuries, for example, in the event of an accident or when braking or changing direction suddenly.

- ▶ Always secure persons under 5 ft (1.50 m) tall in a suitable restraint system.

**▲ WARNING** Danger of injury or death from blocked seat belt buckles

If seat belt buckles are blocked and cannot be moved downwards, the function of the Emergency Tensioning Devices is impaired.

The Emergency Tensioning Devices can no longer function as intended and the seat belts can no longer provide the intended protection.

- ▶ Always ensure that the seat belt buckles are not blocked.

**▲ WARNING** Risk of injury or death due to damaged or modified seat belts

Seat belts cannot provide protection in the following situations:

- If the seat belts are damaged, modified, extremely dirty, bleached or dyed
- If the seat belt buckle is damaged or extremely dirty
- If the Emergency Tensioning Devices, seat belt anchorages or seat belt retractors have been modified

Seat belts may be damaged in an accident, although the damage may not be visible, e.g. due to splinters of glass.

Modified or damaged seat belts may tear or fail, e.g. in an accident.

Modified Emergency Tensioning Devices can accidentally trigger or fail to function as intended.

- ▶ Never modify the seat belts, Emergency Tensioning Devices, seat belt anchorages or seat belt retractors.

- ▶ Make sure that the seat belts are undamaged, not worn and clean.
- ▶ Always have the seat belts checked immediately after an accident at a qualified specialist workshop.

Only use seat belts that have been approved for your vehicle by Mercedes-Benz.

**⚠ WARNING** Risk of injury or death from deployed pyrotechnic Emergency Tensioning Devices

Pyrotechnic Emergency Tensioning Devices that have been deployed are no longer operational and are unable to perform their intended protective function.

- ▶ Therefore, have deployed pyrotechnic Emergency Tensioning Devices immediately replaced at a qualified specialist workshop.

Mercedes-Benz recommends that you have the vehicle towed to a qualified specialist workshop after an accident.

**!** **NOTE** Damage caused by trapping the seat belt

If an unused seat belt is not fully retracted, it may become trapped in the door or in the seat mechanism.

- ▶ Always ensure that an unused seat belt is fully retracted.

### Extending/retracting the seat belt extender

The seat belt extender for the front seat helps you fasten your seat belt. When the door is closed, the seat belt extender extends.

You can also extend the seat belt extender using the seat belt extender button.

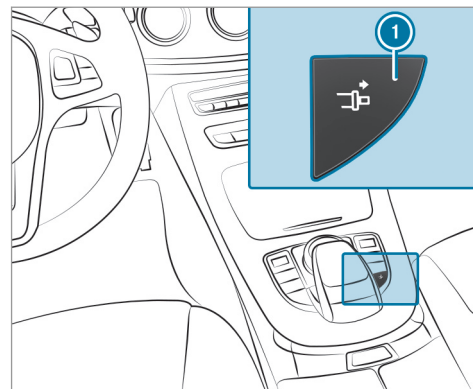

- ▶ Switch on the ignition.
- ▶ Press seat belt extender button ①. The seat belt extender extends.

The seat belt extender is retracted again if:

- the seat belt tongue is engaged in the seat belt buckle
- the seat belt tongue is not engaged in the seat belt buckle within 60 seconds

In this case, press seat-belt extender button ① again. The seat belt extender extends again.

- the respective door is opened
  - you fold the seat backrest forwards
  - nobody is sitting in the front passenger seat
- If you press seat belt extender button ① after this, the seat-belt extender will no longer extend.

The seat belt extender must always be retracted while the vehicle is in motion.

### Fastening seat belts

If the seat belt is pulled quickly or sharply, the seat belt retractor locks. The seat belt strap cannot be pulled out any further.

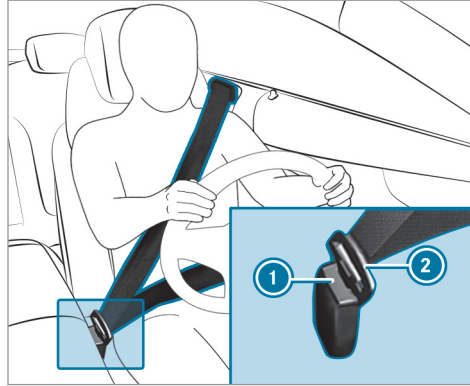

- ▶ Always engage seat belt tongue ② of the seat belt into seat belt buckle ① of the corresponding seat.

**Vehicles with PRE-SAFE®:** If the front seat belt is not pulled tight across your body, the seat belt adjustment may automatically apply a certain tightening force. Do not hold the seat belt tightly while it is adjusting. You can activate and deacti-

vate the seat belt adjustment function using the multimedia system.

### Vehicles with automatic front passenger front air bag shutoff:

- ! **NOTE** Deployment of the Emergency Tensioning Device and side air bag when the front passenger seat is unoccupied

If the seat belt tongue is engaged in the seat belt buckle of the unoccupied front passenger seat, the Emergency Tensioning Device and the side air bag may also deploy in the event of an accident along with other systems.

- ▶ Only one person should use each seat belt at any one time.

### Vehicles without automatic front passenger front air bag shutoff:

**NOTE** Deployment of the Emergency Tensioning Device when the front passenger seat is unoccupied

If the seat belt tongue is engaged in the seat belt buckle of the unoccupied front passenger seat, the Emergency Tensioning Device may also deploy in the event of an accident along with other systems.

▶ Only one person should use each seat belt at any one time.

### Releasing seat belts

▶ Press the release button in the seat belt buckle and guide the seat belt back with the seat belt tongue.

### Activating or deactivating seat belt adjustment via the multimedia system

Multimedia system:

➔ Vehicle ▶  Vehicle Settings ▶ Belt Adjustment

▶ Activate  or deactivate  the function.

### Seat belt warning function for the driver and front passenger

The  seat belt warning lamp in the Instrument Display is a reminder that all vehicle occupants must wear their seat belts correctly.

The  seat belt warning lamp lights up for six seconds after every engine start.

In addition, an acoustic warning tone may sound.

When the driver's and front passenger doors are closed and the driver and front passenger have fastened their seat belts, the seat belt warning goes out.

During a journey, the seat belt warning lights up if:

- The vehicle speed exceeds 15 mph (25 km/h) and the driver's or front passenger seat belt is not fastened.
- The driver or front passenger unfastens their seat belt while the vehicle is in motion.

### Airbags

#### Overview of air bags

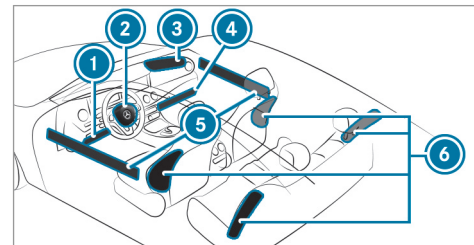

- ① Driver's knee bag
- ② Driver's air bag



- ③ Front passenger front air bag
- ④ Front passenger knee air bag
- ⑤ Head air bag
- ⑥ Side impact air bag

The installation location of an air bag is identified by the AIRBAG symbol.

**When activated, an air bag can provide additional protection for the respective vehicle occupant.**

AIRBAG	Potential protection for ...
Knee air bag	Thigh, knee and lower leg
Driver's airbag, front passenger front air bag	Head and ribcage
Head air bag	Head
Side impact air bag	Ribcage, also pelvis for front seat occupants

The front passenger front air bag can only be deployed in an accident if the PASSENGER AIR

BAG OFF indicator lamp is off. If the front passenger seat is occupied, make sure, both before and during the journey, that the status of the front passenger front air bag is correct (→ page 43).

**!** **NOTE** Important points to remember if the front passenger seat is unoccupied

In an accident, the components of the restraint system may deploy unnecessarily on the front passenger side if:

- There are heavy objects on the front passenger seat.
  - The seat belt tongue is engaged in the seat belt buckle of the front passenger seat and the front passenger seat is unoccupied.
- ▶ Stow objects in a suitable place.  
▶ Only one person should use each seat belt at any one time.

### Protection by the air bags

Depending on the accident situation, an air bag may supplement the protection offered by a correctly fastened seat belt.

**!** **WARNING** Risk of injury or death due to incorrect seat position

If you deviate from the correct seat position, the air bag cannot perform its intended protective function and deployment may even cause further injuries.

To avoid hazardous situations, always make sure that all vehicle occupants:

- Have their seat belt fastened correctly, including pregnant women.
  - Are seated properly and that distance to the air bags is as large as possible.
  - Observe the following information.
- ▶ Always make sure that there are no objects between the air bag and the vehicle occupant.

To avoid the risks resulting from the deployment of an air bag, each vehicle occupant must observe the following information:

- Before starting your journey, adjust your seat correctly; the driver's seat and front passenger seat should be moved as far back as possible.

When doing so, always observe the information on the correct driver's seat position (→ page 85).

- Only hold the steering wheel by the steering wheel rim. This allows the air bag to be fully deployed.
- Always lean against the seat backrest when the vehicle is in motion. Do not lean forwards or against the door or side window. You may otherwise be in the deployment area of the air bags.
- Always keep your feet on the floor. Do not put your feet on the cockpit, for example. Your feet may otherwise be in the deployment area of the air bag.
- If children are traveling in the vehicle, observe the additional notes (→ page 47).

- Always stow and secure objects correctly.

Objects in the vehicle interior may prevent an air bag from functioning correctly. Each vehicle occupant must always make sure of the following:

- There are no people, animals or objects between the vehicle occupants and an air bag.
- There are no objects between the seat, door and door pillar (B-pillar).
- There are no hard objects, e.g. coat hangers, hanging on the grab handles or coat hooks.
- There are no accessory parts, such as cup holders, attached to the vehicle within the deployment area of an air bag, e.g. on doors, side windows or side trim.
- There are no heavy, sharp-edged or fragile objects in the pockets of your clothing. Store such objects in a suitable place.

### Reduced air bag protection

**⚠ WARNING** Risk of injury from modifications to the airbag cover

If you modify an airbag cover or affix objects such as stickers to it, the airbag can no longer function correctly.

- ▶ Never modify an airbag cover and do not affix objects to it.

The installation location of an air bag is identified by the AIRBAG symbol (→ page 38).

**⚠ WARNING** Risk of injury or death due to the use of unsuitable seat covers

Unsuitable seat covers can obstruct or prevent the deployment of air bags integrated into the seats.

Consequently, the air bags cannot protect vehicle occupants as they are designed to do. In addition, operation of the automatic front passenger air bag shutoff may be restricted.

- ▶ You should only use seat covers that have been approved for the corresponding seats by Mercedes-Benz.

**⚠ WARNING** Risk of injury due to malfunctions of the sensors in the door paneling

Sensors to control the airbags are located in the doors. Modifications or work not performed correctly to the doors or door paneling, as well as damaged doors, can lead to the function of the sensors being impaired. The airbags might therefore not function properly any more.

Consequently, the airbags cannot protect vehicle occupants as they are designed to do.

- ▶ Never modify the doors or parts of the doors.
- ▶ Always have work on the doors or door paneling carried out at a qualified specialist workshop.

**⚠ WARNING** Risk of injury due to deployed airbag

A deployed airbag no longer has a protective function and cannot protect as intended in the event of an accident.

- ▶ Have the vehicle towed to a qualified specialist workshop in order to have the deployed airbag replaced.

Have deployed air bags replaced immediately.

### Status of the front passenger airbag

#### Function of the front passenger front air bag shutoff

The automatic front passenger front air bag shutoff is able to detect whether the front passenger seat is occupied by a person or a child restraint system. The front passenger air bag and front passenger knee air bag are then correspondingly either enabled or deactivated.

When installing a child restraint system to the front passenger seat, always make sure of the following:

- Ensure that the child restraint system is positioned correctly (→ page 47).
- Always observe the child restraint system manufacturer's installation instructions.
- Never place objects, e.g. cushions, under or behind the child restraint system.
- Fully retract the seat cushion length adjustment.
- The entire base of the child restraint system must always rest on the sitting surface of the front passenger seat.
- The backrest of the forward-facing child restraint system must, as far as possible, be resting on the seat backrest of the front passenger seat.
- The child restraint system must not touch the roof or be put under strain by the head restraints. Adjust the seat backrest inclination and the head restraint setting accordingly.

**▲ WARNING** Risk of injury or death due to objects between the sitting surface and the child restraint system

Objects between the sitting surface and the child restraint system could affect the function of the automatic front passenger airbag shutoff.

This could result in the front passenger airbag not functioning as intended during an accident.

- ▶ Do not place any objects between the sitting surface and the child restraint system.
- ▶ The entire base of the child restraint system must always rest on the sitting surface of the front passenger seat.
- ▶ The backrest of the forward-facing child restraint system must lie as flat as possible against the backrest of the front passenger seat.
- ▶ Always comply with the child restraint system manufacturer's installation instructions.

A person on the front passenger seat must observe the following information:

- Fasten seat belts correctly.
- Sit in an almost upright seat position with their back against the seat backrest.
- Sit with their feet resting on the floor, if possible.

Otherwise, the front passenger air bag may be deactivated by mistake, for example in the following situations:

- The front passenger transfers their weight by supporting themselves on a vehicle armrest.
- The front passenger sits in such a way that their weight is raised from the sitting surface.

**▲ WARNING** Risk of injury or death due to deactivated front passenger airbag

If the PASSENGER AIR BAG OFF indicator lamp is lit, the front passenger airbag is disabled. It will not be deployed in the event of an accident and cannot perform its intended protective function.

A person in the front passenger seat could then, for example, come into contact with the vehicle interior, especially if the person is sitting too close to the cockpit.

If the front passenger seat is occupied, always ensure that:

- The classification of the person in the front passenger seat is correct and the front passenger airbag is enabled or disabled in accordance with the person in the front passenger seat.
  - The front passenger seat has been moved as far back as possible.
  - The person is seated correctly.
- ▶ Ensure, both before and during the journey, that the status of the front passenger airbag is correct.

### Function of the PASSENGER AIR BAG indicator lamps

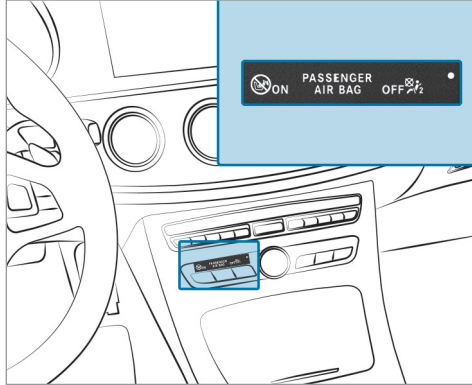

#### System self-test

When the ignition is switched on, a system self-test is performed during which the two PASSENGER AIR BAG ON and OFF indicator lamps light up simultaneously.

The status of the front passenger air bag is displayed after the system self-test:

- PASSENGER AIR BAG ON lights up for 60 seconds, subsequently both PASSENGER AIR BAG ON and OFF indicator lamps are off: the front passenger air bag is able to deploy in the event of an accident.
- PASSENGER AIR BAG OFF lights up continuously: the front passenger air bag is deactivated. It will then not be deployed in the event of an accident.

If the PASSENGER AIR BAG ON indicator lamp is off, only the PASSENGER AIR BAG OFF indicator lamp shows the status of the front passenger air bag. The PASSENGER AIR BAG OFF indicator lamp may be lit continuously or be off.

If the PASSENGER AIR BAG OFF indicator lamp and the  restraint system warning lamp light up simultaneously, the front passenger seat may not be used. Also in this case, do not install a child restraint system on the front passenger seat. Have the automatic front passenger air bag shutoff checked and repaired immediately at a qualified specialist workshop.

#### Status display

If the front passenger seat is occupied, ensure, both before and during the journey, that the status of the front passenger air bag is correct for the prevailing situation.

**After installing a rearward-facing child restraint system to the front passenger seat:** PASSENGER AIR BAG OFF must be lit continuously.

**⚠ WARNING** Risk of injury or death from using a rearward-facing child restraint system when the front passenger air bag is enabled

If you secure a child in a rearward-facing child restraint system on the front passenger seat and the PASSENGER AIR BAG OFF indicator lamp is off, the front passenger air bag can deploy in the event of an accident.

The child could be struck by the air bag.

Always ensure that the front passenger air bag is disabled. The PASSENGER AIR BAG OFF indicator lamp must be lit.

NEVER use a rearward facing child restraint on a seat protected by an ACTIVE FRONT AIR BAG in front of it; DEATH or SERIOUS INJURY to the child can occur.

When installing a child restraint system to the front passenger seat, observe the vehicle-specific information .

Depending on the child restraint system and the stature of the child, the PASSENGER AIR BAG OFF indicator lamp may be off. In this case, do not fit the rearward-facing child restraint system to the front passenger seat.

Instead, fit the rearward-facing child restraint system to a suitable rear seat.

**After installing a forward-facing child restraint system to the front passenger**

**seat:** depending on the child restraint system and the stature of the child, PASSENGER AIR BAG OFF may be lit continuously or be off. Always observe the following information.

**▲ WARNING** Risk of injury or death due to incorrect positioning of the forward-facing child restraint system

If you secure a child in a forward-facing child restraint system on the front passenger seat and you position the front passenger seat too close to the cockpit, in the event of an accident, the child could:

- Come into contact with the vehicle interior if the PASSENGER AIR BAG OFF indicator lamp is lit, for example.
- Be struck by the air bag if the PASSENGER AIR BAG OFF indicator lamp is off.

▶ Always move the front passenger seat as far back as possible and fully retract the seat cushion length adjustment. Always make sure that the shoulder belt strap is correctly routed from the seat belt outlet on the vehicle to the shoulder belt guide on the child restraint system. The shoulder belt strap must be routed forwards and downwards from the vehicle belt outlet. If necessary,

adjust the seat belt outlet and the front passenger seat accordingly.

- ▶ Always observe the child restraint system manufacturer's installation instructions.

When installing a child restraint system to the front passenger seat, observe the vehicle-specific information .

**If a person is sitting in the front passenger seat:** PASSENGER AIR BAG OFF may be lit continuously or be off, depending on the person's stature.

A person on the front passenger seat must always observe the following information:

- If the front passenger seat is occupied with an adult or a person with a stature corresponding to that of an adult, the PASSENGER AIR BAG OFF indicator lamp must be off. This indicates that the front passenger air bag is enabled.

If the PASSENGER AIR BAG OFF indicator lamp is lit continuously, an adult or person with a build corresponding to that of an adult

should not use the front passenger seat. Instead, they should use a rear seat.

- If the front passenger seat is occupied by a person of smaller stature (e.g. a teenager or small adult), the PASSENGER AIR BAG OFF indicator lamp either lights up continuously or remains off, depending on the result of the classification.
  - PASSENGER AIRBAG OFF is off: move the front passenger seat as far back as possible or a person of smaller stature should use a rear seat.
  - If the PASSENGER AIRBAG OFF indicator lamp is lit continuously: a person of smaller stature should not use the front passenger seat.

**⚠ WARNING** Risk of injury or death when the PASSENGER AIR BAG OFF indicator lamp is lit

If the PASSENGER AIR BAG OFF indicator lamp remains lit after the system self-test, the front passenger air bag is deactivated. It will not be deployed in the event of an acci-

dent. In this case, the front passenger air bag cannot perform its intended protective function, e.g. when a person is seated in the front passenger seat.

That person could, for example, come into contact with the vehicle interior, especially if the person is sitting too close to the cockpit.

If the front passenger seat is occupied, always ensure that:

- The classification of the person in the front passenger seat is correct and the front passenger air bag is enabled or deactivated in accordance with the person in the front passenger seat.
- The person is seated properly with a correctly fastened seat belt.
- The front passenger seat has been moved as far back as possible.

#### Further related subjects:

- Child restraint system on the front passenger seat (→ page 54).

## Roll bar

**⚠ DANGER** Risk of injury or death caused by a malfunction of the roll bars

If the function of the roll bars is defective, they may not extend in an accident for example.

Consequently, the roll bars cannot protect vehicle occupants as they are designed to do.

- ▶ Have the roll bars checked immediately at a qualified specialist workshop.

**⚠ WARNING** Risk of injury when the roll bars are triggered

If the roll bars are triggered, there is a risk of injury.

Always make sure that there is nothing in the sweep of the roll bars.

**⚠ WARNING** Danger of injury or death from obstructed roll bars

If you leave objects or items of clothing on the covers of the roll bars, this may restrict the roll bars as they extend.

Consequently, the roll bars cannot protect as they are designed to do. Furthermore, the objects may endanger vehicle occupants when the roll bars extend.

- ▶ Always make sure that there is nothing in the sweep of the roll bars.
- ▶ Always stow and secure objects in the vehicle correctly.

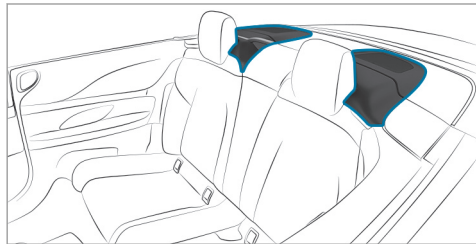

The roll bars are under the covers behind the rear head restraints. The roll bars are triggered when danger of the vehicle rolling over is detected.

Once the roll bars have been triggered, you can no longer close a soft top that is open. In this case, consult the next qualified specialist workshop.

### PRE-SAFE® system

#### PRE-SAFE® (Pre-Crash Safety-System)

PRE-SAFE® is able to detect certain critical driving situations and implement pre-emptive measures to protect the vehicle occupants.

PRE-SAFE® can implement the following measures independently of each other:

- Tightening the seat belts on the driver's seat and front passenger seat.
- Closing the side windows.
- **Vehicles with memory function:** moving the front passenger seat to a more favorable seat position.

- **Vehicles with multicontour seat:** increasing the air pressure in the seat side bolsters of the seat backrest.
- PRE-SAFE® Sound: provided that the multimedia system is switched on, generates a brief noise signal to stimulate the innate protective mechanism of a person's hearing.

**!** **NOTE** Damage caused by objects in the footwell or behind the seat

The automatic adjustment of the seat position may result in damage to the seat and/or the object.

- ▶ Stow objects in a suitable place.

#### Reversing the PRE-SAFE® system measures

If an accident did not occur, the pre-emptive measures that were taken are reversed.

You will need to perform certain settings yourself.



- ▶ If the seat belt pre-tensioning is not reduced, move the seat backrest back slightly. The locking mechanism releases.

### Function of PRE-SAFE® PLUS (anticipatory occupant protection plus)

PRE-SAFE® PLUS can detect certain impacts, particularly an imminent rear impact, and take pre-emptive measures to protect the vehicle occupants. These measures cannot necessarily prevent an imminent impact.

PRE-SAFE® PLUS can implement the following measures independently of each other:

- Tightening the seat belts on the driver's seat and front passenger seat.
- Increasing brake pressure when the vehicle is stationary. This brake application is canceled automatically when the vehicle pulls away.

If an accident did not occur, the pre-emptive measures that were taken are reversed.

### System limitations

The system will not initiate any action in the following situations:

- when reversing

The system will not initiate any braking application in the following situations:

- whilst driving  
or
- when entering or exiting a parking space while using Active Parking Assist

### Children in the vehicle

#### Notes on the safe transportation of children

**⚠ WARNING** Risk of accident and injury due to children left unattended in the vehicle

If you leave children unaccompanied in the vehicle, they may be able to set the vehicle in motion, for example by:

- Releasing the parking brake.
- Shifting the transmission out of park position **P**.
- Starting the engine.

In addition, they may operate vehicle equipment.

- ▶ Never leave children and animals unattended in the vehicle.
- ▶ When leaving the vehicle, always take the SmartKey with you and lock the vehicle.

**▲ WARNING** Risk of fatal injury due to exposure to extreme heat or cold in the vehicle

If people – particularly children – are exposed to extreme heat or cold over an extended period of time, there is a risk of injury or even fatal injury.

- ▶ Never leave anyone – particularly children – unattended in the vehicle.

**▲ WARNING** Risk of burns when the child seat is exposed to direct sunlight

If the child restraint system is exposed to direct sunlight or heat, parts could heat up. Children could suffer burns from these parts, particularly on metallic parts of the child restraint system.

- ▶ Always make sure that the child restraint system is not exposed to direct sunlight.
- ▶ Protect it with a blanket, for example.

- ▶ If the child restraint system has been exposed to direct sunlight, allow it to cool before securing a child into it.
- ▶ Never leave children unattended in the vehicle.

The use of seat belts and child restraint systems is required by law in:

- All 50 states
- The U.S. territories
- The District of Columbia
- All Canadian provinces

All child restraint systems must meet the following standards:

- U.S. Federal Motor Vehicle Safety Standards 213 and 225
- Canadian Motor Vehicle Safety Standards 213 and 210.2

You can obtain further information about the correct child restraint system from any authorized Mercedes-Benz Center.

To improve protection for children younger than 12 years old or under 5 ft (1.50 m) in height, Mercedes-Benz recommends you observe the following information:

- Only secure children using a child restraint system which is appropriate to the height, age and weight of the child and suitable for Mercedes-Benz vehicles. Be sure to observe the instructions for correct use of the child restraint system.
- Always install a child restraint system on a rear seat if possible.
- Only use the following securing systems for child restraint systems:
  - the seat belt system
  - the LATCH-type (ISOFIX) mounting brackets
  - the Top Tether anchorages
- The manufacturer's installation instructions for the child restraint system.
- The warning labels in the vehicle interior and on the child restraint system.

**▲ WARNING** Risk of injury or death caused by incorrect installation of the child restraint system

If the child restraint system is incorrectly installed on a suitable seating position, it cannot perform its intended protective function.

The child cannot be restrained in the event of an accident, heavy braking or a sudden change of direction.

- ▶ Always comply with the manufacturer's installation instructions for the child restraint system and its correct use.
- ▶ Make sure that the entire base of the child restraint system always rests on the sitting surface of the seat.
- ▶ Never place objects under or behind the child restraint system, e.g. cushions.
- ▶ Always use child restraint systems with the original cover designed for them.
- ▶ Always replace damaged covers with genuine covers.

**▲ WARNING** Risk of accident caused by incorrectly installed child restraint systems

If the child restraint system is not correctly installed or secured, it could release in the event of an accident, sudden braking or a sudden change in direction.

The child restraint system could be flung around and hit vehicle occupants. This poses an increased risk of injury or even fatal injury.

- ▶ Always install child restraint systems correctly, even when not in use.
- ▶ Always comply with the child restraint system manufacturer's installation instructions.

**▲ WARNING** Risk of injury or death caused by the use of damaged child restraint systems

Child restraint systems or their retaining systems that have been subjected to a load in

an accident may then not be able to perform their intended protective function.

The child cannot be restrained in the event of an accident, heavy braking or a sudden change of direction.

- ▶ Always replace child restraint systems immediately that have been damaged or involved in an accident.
- ▶ Have the securing systems for the child restraint systems checked at a qualified specialist workshop before installing a child restraint system again.

A booster seat may be necessary to achieve proper seat belt positioning for children over 40 lbs (18 kg) in weight or until they reach a height where a three-point seat belt can be installed properly without a booster seat.

The following notes must be observed:

- When installing a child restraint system on the front passenger seat, the information on installing a child restraint system on the front passenger seat (→ page 54).

- Instructions and safety notes on the automatic front passenger airbag shutoff (→ page 41).
- Safety notes on the seat belt (→ page 33).
- Information on the correct use of the seat belt (→ page 38).

### Activating/deactivating the child seat safety feature of the seat belt

**⚠ WARNING** Risk of injury or death if a seat belt is unfastened while the vehicle is in motion

If the seat belt is released while the vehicle is in motion, the child restraint system is no longer correctly secured. The child seat safety feature is deactivated and the seat belt is drawn in a bit by the inertia reel.

It is therefore not possible to engage the seat belt again.

- ▶ Pull over and stop the vehicle safely as soon as possible, paying attention to road and traffic conditions.

- ▶ Activate the child seat safety feature again and correctly secure the child restraint system.

When enabled, the child seat safety feature ensures that the seat belts of the front passenger seat and rear seats do not slacken once the child restraint system is secured.

#### Installing a child restraint system:

- ▶ Always comply with the manufacturer's installation instructions when installing and removing the child restraint system.
- ▶ Pull the seat belt smoothly from the seat belt outlet.
- ▶ Engage the seat belt tongue in the seat belt buckle.

#### Activating the child seat safety feature:

- ▶ Pull the seat belt out fully and let the inertia reel retract it again. When the child seat safety feature is activated, you should hear a ratcheting sound.
- ▶ Push the child restraint system down until the seat belt sits tightly.

#### Deactivating the child seat safety feature:

- ▶ Press the release button of the seat belt buckle.
- ▶ Hold the seat belt tongue and guide it back to the seat belt outlet.

### LATCH-type (ISOFIX) child seat attachment

#### Notes on LATCH-type (ISOFIX) child seat attachments

**⚠ WARNING** Risk of injury or death if the maximum permissible gross mass for using a LATCH-type (ISOFIX) child restraint system is exceeded

For LATCH-type (ISOFIX) child restraint systems in which the child is secured using the integrated seat belt integrated in the child restraint system, the permissible gross mass of the child and child restraint system is 73 lb (33 kg).

If the child and the child restraint system together weigh more than 73 lb (33 kg), the

LATCH-type (ISOFIX) child restraint system with integrated seat belt does not offer sufficient protection. An excessive load may be placed on the LATCH-type (ISOFIX) child seat attachments and the child may not be restrained in the event of an accident, for example.

- ▶ If the child and the child restraint system together weigh more than 73 lb (33 kg), only use a LATCH-type (ISOFIX) child restraint system which secures the child with the vehicle seat belt.
- ▶ Also secure the child restraint system with the Top Tether belt, if available.

Always comply with the information about the mass of the child restraint system:

- in the manufacturer's installation and operating instructions for the child restraint system used
- on a label on the child restraint system, if present

Regularly check that the permissible gross mass of the child and child restraint system is still being adhered to.

When using a child restraint system, be sure to observe the manufacturer's installation and operating instructions as well as its correct use and the suitability of the seats for attaching a child restraint system.

ISOFIX is a standardized securing system for specially designed restraint systems. LATCH-type (ISOFIX) child restraint systems are approved in accordance with ECE R44.

Only child restraint systems that have been approved in accordance with ECE R44 may be attached to LATCH-type (ISOFIX) mounting brackets.



Symbol for fitting a LATCH-type (ISOFIX) child restraint system

### Installing LATCH-type (ISOFIX) child seat securing systems

**⚠ WARNING** Risk of injury or death if the maximum permissible gross mass for using a LATCH-type (ISOFIX) child restraint system is exceeded

For LATCH-type (ISOFIX) child restraint systems in which the child is secured using the integrated seat belt integrated in the child restraint system, the permissible gross mass of the child and child restraint system is 73 lb (33 kg).

If the child and the child restraint system together weigh more than 73 lb (33 kg), the LATCH-type (ISOFIX) child restraint system with integrated seat belt does not offer sufficient protection. An excessive load may be placed on the LATCH-type (ISOFIX) child seat attachments and the child may not be restrained in the event of an accident, for example.

▶ If the child and the child restraint system together weigh more than 73 lb (33 kg), only use a LATCH-type (ISOFIX)

child restraint system which secures the child with the vehicle seat belt.

▶ Also secure the child restraint system with the Top Tether belt, if available.

Always comply with the information about the mass of the child restraint system:

- in the manufacturer's installation and operating instructions for the child restraint system used
- on a label on the child restraint system, if present

Regularly check that the permissible gross mass of the child and child restraint system is still being adhered to.

When using a child restraint system, be sure to observe the manufacturer's installation and operating instructions as well as its correct use and the suitability of the seats for attaching a child restraint system.

Before every trip, make sure that the LATCH-type (ISOFIX) child restraint system is engaged correctly in both LATCH-type (ISOFIX) mounting brackets.

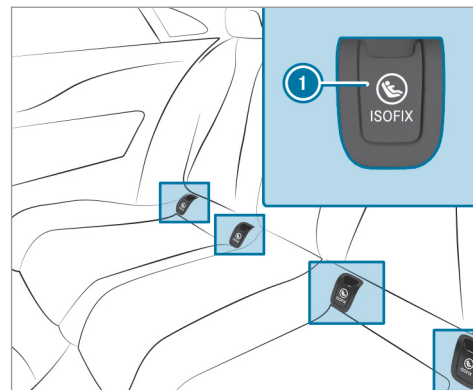

#### ① LATCH-type (ISOFIX) mounting brackets

- ▶ Remove each cover for LATCH-type (ISOFIX) mounting brackets ①.
- ▶ Attach the LATCH-type (ISOFIX) child restraint system to both LATCH-type (ISOFIX) mounting brackets ①.

- ▶ After removing the child seat, replace each cover for LATCH-type (ISOFIX) mounting brackets ①.

### Securing Top Tether

**⚠ WARNING** Risk of injury or death if the rear seat backrests are not locked after installing Top Tether belts

If the rear seat backrests are not locked, they could fold forwards in the event of an accident or during braking or sudden changes of direction.

As a result, child restraint systems cannot perform their intended protective function. Rear seat backrests that are not locked can also cause additional injuries, e.g. in the event of an accident.

- ▶ Always lock rear seat backrests after installing Top Tether belts.
- ▶ Observe the lock verification indicator.

If the seat backrest is not engaged and locked, this will be shown on the multifunction display on the instrument cluster.

The risk of injury can be reduced by Top Tether as Top Tether provides an additional connection between the child restraint system secured with LATCH-type (ISOFIX) and the vehicle.

The child restraint system must be equipped with a Top Tether belt.

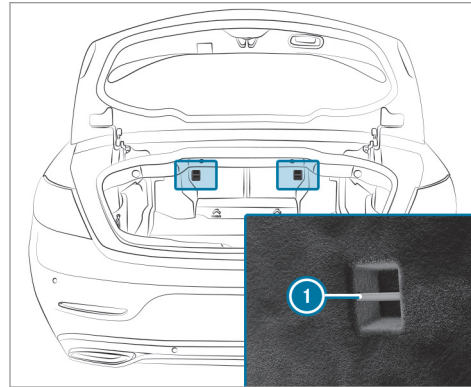

- ▶ Install the LATCH-type (ISOFIX) child restraint system with Top Tether on the rear seat. Always comply with the child restraint system manufacturer's installation instructions when doing so.

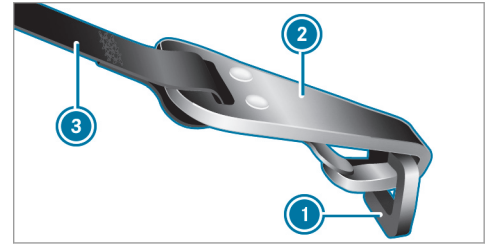

- ▶ Fold the rear seat backrest forwards (→ page 101).
- ▶ Hook Top Tether hook ② into Top Tether anchorage ①.
- ▶ Fold the rear seat backrest back (→ page 102).
- ▶ Make sure that Top Tether belt ③ is not twisted and the rear seat backrest is locked.

- ▶ Secure the child restraint system with LATCH-type (ISOFIX) (→ page 52).
- ▶ Tension Top Tether belt ③ from the trunk.
- ▶ Make sure that there is sufficient seat belt strap to pull tight.
- ▶ Always comply with the child restraint system manufacturer's installation instructions when doing so.

### Child restraint systems on the front passenger seat

#### Notes on child restraint systems on the front passenger seat

Accident statistics show that children secured in the rear seats are safer than children secured in the front seats. For this reason, Mercedes-Benz strongly advises that you install a child restraint system on a rear seat.

If it is absolutely necessary to install a child restraint system on the front passenger seat, always observe the information on the automatic front passenger airbag shutoff (→ page 41).

By doing this, you can avoid risks caused by:

- A child restraint system that is not detected by the automatic front passenger airbag shutoff.
- The unintentionally deactivated front passenger airbag.
- Incorrect positioning of the child restraint system.

#### Notes on forward-facing and rearward-facing child restraint systems on the front passenger seat

When using a rearward-facing child restraint system on the front passenger seat, the front passenger front air bag must always be deactivated. This is only the case if the PASSENGER AIR BAG OFF indicator lamp is lit continuously (→ page 43).

When using the child restraint system on the front passenger seat, it is essential to observe the following:

- Move the front passenger seat as far back as possible.

- Set the seat backrest to an almost vertical position.
- Retract the seat cushion length as far as possible.
- The entire base of the child restraint system must always rest on the sitting surface of the front passenger seat.
- The backrest of the forward-facing child restraint system must lie as flat as possible against the seat backrest of the front passenger seat. The child restraint system must not touch the roof or be put under strain by the head restraints.
- If necessary, adjust the angle of the seat backrest and the head restraint position accordingly.
- Adjust the seat cushion inclination so that the front edge of the seat cushion is in the highest position and the rear edge of the seat cushion is in the lowest position.
- Always make sure that the shoulder belt strap is correctly routed from the seat belt outlet of the vehicle to the shoulder belt guide on the child restraint system. The



shoulder belt strap must be routed forwards and downwards from the seat belt outlet.

- If necessary, adjust the seat belt outlet and the front passenger seat accordingly.
- Never place objects under or behind the child restraint system, e.g. cushions.

Always comply with the manufacturer's installation and operating instructions for the child restraint system used.

### Child safety locks

#### Activating/deactivating the child safety lock for the rear side windows

**⚠ WARNING** Risk of accident and injury due to children left unattended in the vehicle

If you leave children unaccompanied in the vehicle, they may be able to set the vehicle in motion, for example by:

- Releasing the parking brake.

- Shifting the transmission out of park position **P**.
- Starting the engine.

In addition, they may operate vehicle equipment.

- ▶ Never leave children and animals unattended in the vehicle.
- ▶ When leaving the vehicle, always take the SmartKey with you and lock the vehicle.

**⚠ WARNING** Risk of fatal injury due to exposure to extreme heat or cold in the vehicle

If people – particularly children – are exposed to extreme heat or cold over an extended period of time, there is a risk of injury or even fatal injury.

- ▶ Never leave anyone – particularly children – unattended in the vehicle.

**⚠ WARNING** There is a risk of accident and injury if you leave children unattended in the vehicle

If children are traveling in the vehicle, they could:

- Open doors, thereby endangering other persons or road users.
- Get out of the vehicle and be hit by oncoming traffic.
- Operate vehicle equipment and become trapped, for example.
  - ▶ Always activate the child safety locks available if children are traveling in the vehicle.
  - ▶ Never leave children unattended in the vehicle.
  - ▶ When leaving the vehicle, always take the SmartKey with you and lock the vehicle.

Child safety locks are available for the side windows in the rear passenger compartment.

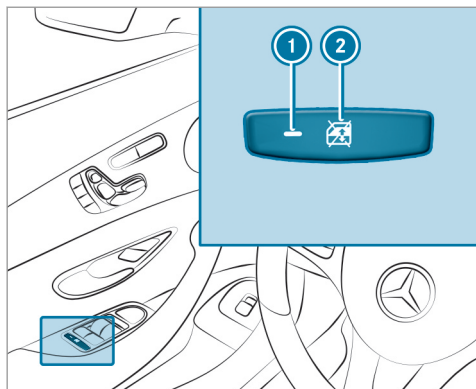

- ▶ **To activate/deactivate:** press button ②.  
Opening/closing the side window in the rear passenger compartment is possible:
- With indicator lamp ① lit: via the switch on the driver's door.
  - With indicator lamp ① off: via the switch on the corresponding rear door or driver's door.

### Notes on pets in the vehicle

**⚠ WARNING** Risk of accident and injury due to animals left unsecured or unattended in the vehicle

If you leave animals in the vehicle unattended or unsecured, they could possibly press down buttons or switches.

Thereby an animal may:

- activate vehicle equipment and become trapped, for example
- switch systems on or off and endanger other road users

Unsecured animals may be thrown around in the vehicle in the event of an accident or sudden steering and braking maneuver and injure vehicle occupants in the process.

- ▶ Never leave animals in the vehicle unattended.
- ▶ Always correctly secure animals while driving, for example using a suitable animal carrier.

## SmartKey

### Overview of SmartKey functions

**⚠ WARNING** Risk of accident and injury due to children left unattended in the vehicle

If children are left unattended in the vehicle, they could:

- Open doors, thereby endangering other persons or road users.
- Get out of the vehicle and be hit by oncoming traffic.
- Operate vehicle equipment and become trapped, for example.

In addition, children could also set the vehicle in motion, for example, by:

- Releasing the parking brake.
- Shifting the automatic transmission out of park position **P** or shifting manual transmission into neutral.
- Starting the engine

- ▶ When leaving the vehicle, always take the SmartKey with you and lock the vehicle.
- ▶ Never leave children and animals unattended in the vehicle.
- ▶ Keep the SmartKey out of reach of children.

**⚠ NOTE** Damage to the key caused by magnetic fields

- ▶ Keep the key away from strong magnetic fields.

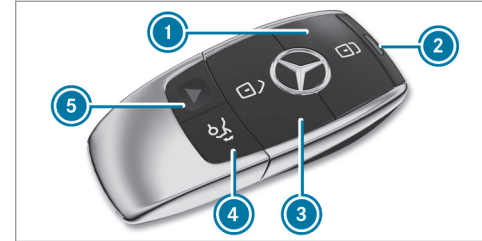

- ① Locks
- ② Battery check lamp
- ③ Unlocks
- ④ Opens/closes the trunk lid
- ⑤ Panic alarm

The SmartKey locks and unlocks the following components:

- The doors
- The trunk lid
- The fuel filler flap

If you do not open the vehicle within approximately 40 seconds after unlocking:

- The vehicle is locked again
- Anti-theft protection is reactivated

Do not keep the SmartKey together with electronic devices or metal objects. This can affect the SmartKey's functionality.

① If battery check lamp ② does not light up after pressing the  or  button, the battery is discharged.

Changing the SmartKey battery (→ page 59).

### Activating/deactivating the acoustic locking verification signal

Multimedia system:

→ Vehicle ►  Vehicle Settings ► Acoustic Lock

► Activate  or deactivate  the function.

### Activating/deactivating the panic alarm

#### Requirements

- ① The panic alarm function is only available in certain countries.
- The ignition is switched off.





- **To activate:** press button ① for approximately one second. A visual and audible alarm is triggered.
  - **To deactivate:** briefly press button ① again.
- or
- Press the start/stop button on the dashboard (the SmartKey is inside the vehicle).

### Changing the unlocking settings

Possible unlocking functions of the SmartKey:

- Central unlocking
- Unlocking the driver's door and fuel filler flap

► **To switch between settings:** press the  and  buttons simultaneously for approximately six seconds until the battery check lamp flashes twice.

If the unlocking function for the driver's door and fuel filler flap has been selected:

- Pressing the  button a second time centrally unlocks the vehicle.
- **Vehicles with KEYLESS-GO:** if you touch the inner surface of the door handle on the driver's door, only the driver's door and fuel filler flap are unlocked.

### Reducing the energy consumption of the SmartKey

**All vehicles:** if you do not use the vehicle or a SmartKey for an extended period of time, you can reduce the energy consumption of the

respective SmartKey. To do so, deactivate the SmartKey functions.

- ▶ **To deactivate:** press the  button on the SmartKey twice in rapid succession. The battery check lamp of the SmartKey flashes twice briefly and lights up once.
  - ▶ **To activate:** press any button on the SmartKey.
- i** When the vehicle is started with the SmartKey in the stowage compartment of the center console, the SmartKey functions are automatically activated (→ page 132).

### Removing/inserting the mechanical key

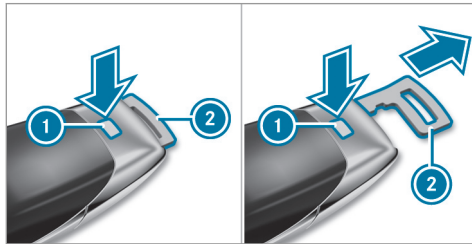

- ▶ **To remove:** press release knob **1**. Mechanical key **2** is pushed out slightly.
  - ▶ Pull out mechanical key **2** until it engages in the intermediate position.
- i** You can use the intermediate position of mechanical key **2** to attach the key to a key ring.
- ▶ Press release knob **1** again and fully remove mechanical key **2**.
  - ▶ **To insert:** press release knob **1**.
  - ▶ Insert mechanical key **2** to the intermediate position or fully until it engages.

### Replacing the SmartKey battery

**⚠ DANGER** Serious damage to health caused by swallowing batteries

Batteries contain toxic and corrosive substances. Swallowing batteries may cause serious damage to health.

There is a risk of fatal injury.

- ▶ Keep batteries out of the reach of children.
- ▶ If batteries are swallowed, seek medical attention immediately.

**🔥 ENVIRONMENTAL NOTE** Environmental damage caused by improper disposal of batteries



Batteries contain pollutants. It is illegal to dispose of them with the household rubbish.



Dispose of batteries in an environmentally responsible manner. Take discharged batteries to a qualified specialist workshop or to a collection point for used batteries.

**Requirements:**

- You require a CR 2032 3 V cell battery.

Mercedes-Benz recommends that you have the battery replaced at a qualified specialist workshop.

- ▶ Remove the emergency key (→ page 59).

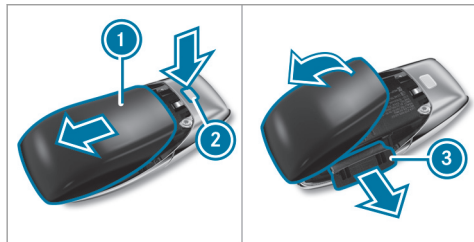

- ▶ Press release button ② down fully and slide cover ① in the direction of the arrow.
- ▶ Fold out cover ① in the direction of the arrow and remove.
- ▶ Remove battery compartment ③ and take out the discharged battery.
- ▶ Insert the new battery into battery compartment ③. Observe the positive pole marking in the battery compartment and on the battery.
- ▶ Push in battery compartment ③.
- ▶ Re-attach cover ① and push it until it engages.

**Problems with the SmartKey**

Problem	Possible causes/consequences and ▶ Solutions
<p>You can no longer lock or unlock the vehicle.</p>	<p>Possible causes are:</p> <ul style="list-style-type: none"> <li>• The SmartKey battery is discharged or nearly discharged.</li> <li>• There is interference from a powerful radio signal source.</li> </ul>

Problem	Possible causes/consequences and ► Solutions
	<ul style="list-style-type: none"><li>• The SmartKey is defective.</li><li>► Check the battery using the battery check lamp and replace if necessary.</li><li>► Use the mechanical key to lock or unlock.</li><li>► Have the SmartKey checked at a qualified specialist workshop.</li></ul>
You have lost a SmartKey.	<ul style="list-style-type: none"><li>► Have the SmartKey deactivated at a qualified specialist workshop.</li><li>► If necessary, have the locks changed as well.</li></ul>

## Doors

### Unlocking and opening doors from the inside

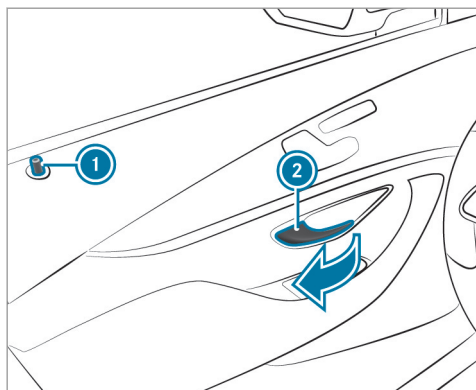

- ▶ Pull door handle ②.
- ▶ Locking pin ① pops up when the door is unlocked.

### Centrally locking and unlocking the vehicle from the inside

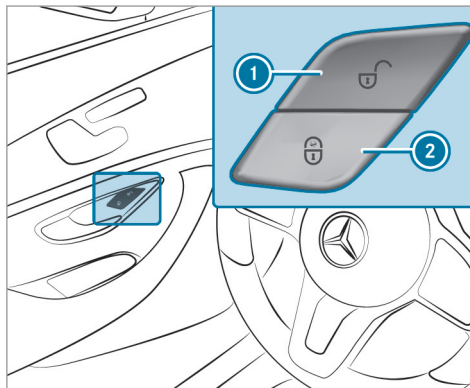

- ▶ **To unlock:** press button ①.
- ▶ **To lock:** press button ②.

This does not lock or unlock the fuel filler flap.

The vehicle is not unlocked:

- If you have locked the vehicle using the SmartKey.
- If you have locked the vehicle using KEY-LESS-GO.

### Locking/unlocking the vehicle with KEY-LESS-GO

#### Requirements:

- The SmartKey is outside the vehicle.
- The distance between the SmartKey and the vehicle does not exceed 3 ft (1 m).
- The driver's door and the door at which the door handle is used are closed.



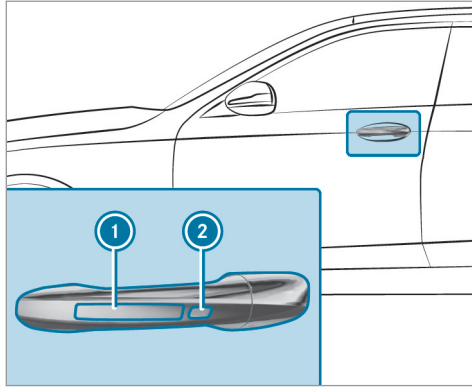

▶ **To unlock the vehicle:** touch the inner surface of the door handle.

▶ **To lock the vehicle:** touch sensor surface ① or ②.

▶ **Convenience closing:** touch recessed sensor surface ② for an extended period.

① Further information on convenience closing (→ page 74).

If you open the trunk lid from outside it is automatically unlocked.

### Problems with KEYLESS-GO

Problem	Possible causes/consequences and ▶ Solutions
<p>You can no longer lock or unlock the vehicle using KEYLESS-GO.</p>	<p>Possible causes are:</p> <ul style="list-style-type: none"> <li>• KEYLESS-GO has been deactivated .</li> <li>• The SmartKey battery is discharged or nearly discharged.</li> <li>• There is interference from a powerful radio signal source.</li> </ul>

Problem	Possible causes/consequences and ► Solutions
	<ul style="list-style-type: none"> <li>• The SmartKey is defective.</li> <li>► Activate KEYLESS-GO .</li> <li>► Check the battery using the battery check lamp and replace if necessary .</li> <li>► Use the mechanical key to lock or unlock the vehicle .</li> <li>► Have the vehicle and SmartKey checked at a qualified specialist workshop.</li> </ul>

### Activating/deactivating the automatic locking feature

The vehicle is locked automatically when the ignition is switched on and the wheels are turning faster than walking pace.

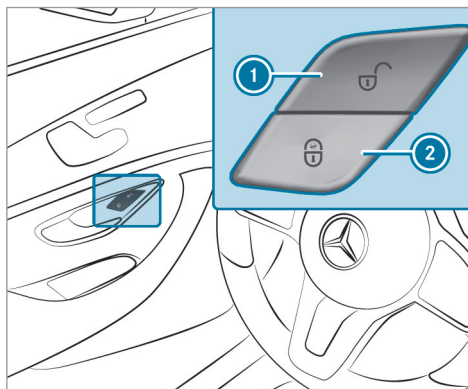

- **To activate:** press and hold button ② for approximately five seconds until an acoustic signal sounds.
- **To deactivate:** press and hold button ① for approximately five seconds until an acoustic signal sounds.

There is a danger of being locked out if the function is activated:

- While the vehicle is being tow started/ pushed.
- On a roller dynamometer.

### Locking/unlocking the driver's door with the mechanical key

**i** If you wish to lock the vehicle entirely using the mechanical key, first press the button for locking from the inside while the driver's door is open. Then proceed to lock the driver's door using the mechanical key.

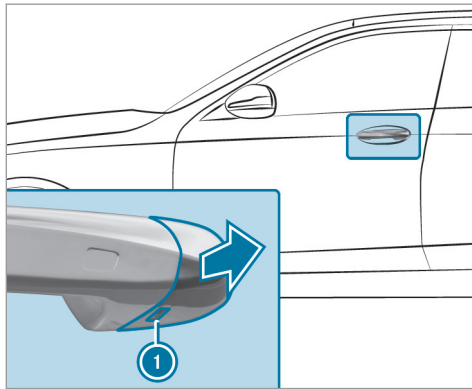

- ▶ Insert the mechanical key as far as it will go into opening **1** in the cover.
- ▶ Pull and hold the door handle.
- ▶ Pull the cover on the mechanical key as straight as possible away from the vehicle until it releases.
- ▶ Release the door handle.

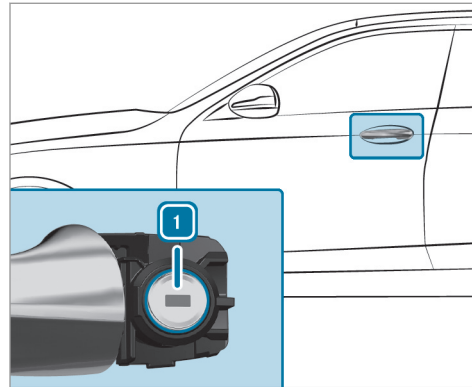

- ▶ **To unlock:** turn the mechanical key counter-clockwise to position **1**.
- ▶ **To lock:** turn the mechanical key clockwise to position **1**.
- ▶ Carefully press the cover onto the lock cylinder until it engages and is seated firmly.

### Trunk

#### Opening the trunk lid

**⚠ WARNING** Risk of exhaust gas poisoning

Combustion engines emit poisonous exhaust gases such as carbon monoxide. Exhaust gases can enter the vehicle interior if the trunk lid is open when the engine is running, especially if the vehicle is in motion.

- ▶ Always switch off the engine before opening the trunk lid.
- ▶ Never drive with the trunk lid open.

**NOTE** Damage to the trunk lid by obstacles above the vehicle

The trunk lid swings upwards when it is opened.

- ▶ Therefore, make sure that there is sufficient clearance above the trunk lid.

**You have the following options to open the trunk lid:**

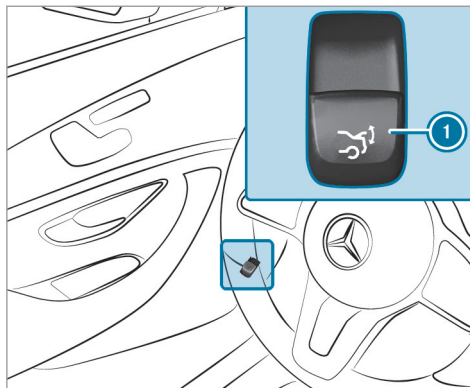

- ▶ Pull trunk lid remote operating switch ①.
  - ▶ Press and hold the  button on the SmartKey.
  - ▶ With the trunk lid unlocked, press the top of the star.
- ① To open, pull on the folded-out star when the rear view camera is activated.

- ▶ **Vehicles with HANDS-FREE ACCESS:** move your foot below the bumper (→ page 69).
- ▶ **Vehicles with trunk lid convenience closing feature:** with the trunk lid stopped in an intermediate position, pull it upwards and release as soon as it begins to open. With the trunk lid opening limiter switched on, manually pull the stopped trunk lid upwards.

**Vehicles with trunk lid convenience closing:** if an object restricts the trunk lid during the automatic opening process, the object recognition function stops the trunk lid. The object recognition function is only an aid and is not a substitute for your attentiveness.

### Closing the trunk lid

**WARNING** Risk of injury from unsecured items in the vehicle

If objects, luggage or loads are not secured or not secured sufficiently, they could slip,

tip over or be thrown around and thereby hit vehicle occupants.

There is a risk of injury, particularly in the event of sudden braking or a sudden change in direction.

- ▶ Always stow objects in such a way that they cannot be thrown around.
- ▶ Before the journey, secure objects, luggage or loads against slipping or tipping over.

**⚠ WARNING** Risk of becoming trapped during automatic closing of the trunk lid

Parts of the body could become trapped during automatic closing of the trunk lid. Moreover, people, e.g. children, may be standing in the closing area or may enter the closing area during the closing process.

- ▶ Make sure that nobody is in the vicinity of the closing area during the closing process.
- ▶ Use one of the following options to stop the closing process:

- Press the  button on the SmartKey.
- Press or pull the remote operating switch on the driver's door.
- Press the closing or locking button on the trunk lid.
- Press the top of the star on the trunk lid.

**Vehicles with HANDS-FREE ACCESS:** It is also possible to stop the closing process by moving your foot in a kicking motion under the rear bumper.

**You have the following options to close the trunk lid:**

- ▶ Pull the trunk lid down using the handle recess and push it closed.
- ▶ **Vehicles with HANDS-FREE ACCESS:** With the trunk lid completely opened, kick your foot below the bumper (→ page 69).
- ▶ **Vehicles with trunk lid convenience closing and KEYLESS-GO:** With the trunk lid completely opened, press and hold the .

button on the trunk (with the SmartKey in the vicinity of the vehicle).

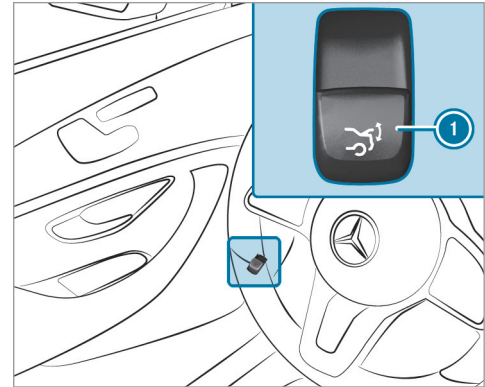

- ▶ **Vehicles with trunk lid convenience closing:** Press trunk lid remote operating switch .

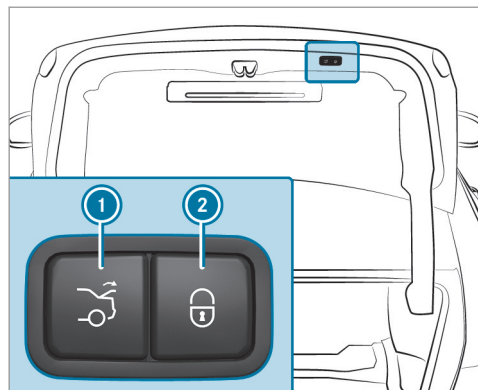

▶ **Vehicles with trunk lid convenience closing:** Press closing button ① in the trunk lid.

▶ **Vehicles with trunk lid convenience closing and KEYLESS-GO:** Press locking button ② in the trunk lid.

If a SmartKey is detected outside the vehicle, the trunk lid closes and the vehicle is locked.

### Automatic reversing function of the trunk lid

If an object restricts the trunk lid during the automatic closing process, the trunk lid opens again automatically. The automatic reversing function is only an aid and is not a substitute for your attentiveness.

▶ When closing, make sure that no body parts are in the closing area.

**⚠ WARNING** Risk of becoming trapped despite the reversing function

The reversing function does not react:

- to soft, light and thin objects, e.g. fingers.
- over the last  $\frac{1}{3}$  in (8 mm) of the closing path.

In these situations in particular, the reversing function cannot prevent someone being trapped.

- ▶ When closing, make sure that no body parts are in the closing area.
- ▶ If someone is trapped, use one of the following options:

- Press the  button on the SmartKey.
- Press the remote operating switch on the driver's door.
- Press the closing or locking button on the trunk lid.
- Press the top of the star on the trunk lid.

## HANDS-FREE ACCESS function

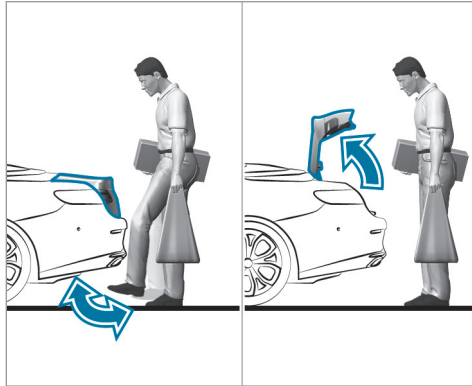

With HANDS-FREE ACCESS you can open or interrupt trunk lid movement by performing a kicking movement under the rear bumper.

Observe the notes when opening (→ page 65) the trunk lid.

**⚠ WARNING** Risk of burns caused by a hot exhaust system

The vehicle exhaust system can become very hot. If you use HANDS-FREE ACCESS, you could burn yourself by touching the exhaust system.

- ▶ Always ensure that you only make a kicking movement within the detection range of the sensors.

**⚠ NOTE** Damage to the vehicle caused by unintentionally opening the trunk lid

- When using an automatic car wash
  - When using a high pressure cleaner
- ▶ Deactivate KEYLESS-GO or make sure that the SmartKey located is at least 10 ft (3 m) away from the vehicle in such situations.

When making the kicking movement, make sure that your feet are firmly on the ground, otherwise you could lose your balance, e.g. on ice.

### Requirements:

- The SmartKey is behind the vehicle.
- Stand at least 12 in (30 cm) away from the vehicle while performing the kicking movement.
- Do not come into contact with the bumper while making the kicking movement.
- Do not carry out the kicking movement too slowly.
- The kicking movement must be towards the vehicle and back.

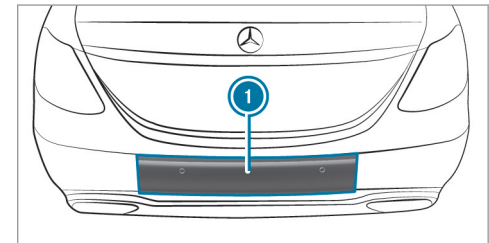

① Sensor detection range

If several consecutive kicking movements are not successful, wait ten seconds.

### System limitations

The system may be impaired or may not function if:

- Snow or dirt, e.g. from road salt, covers the sensor area.
- The kicking movement is made using a prosthetic leg.

The trunk lid could be opened or closed unintentionally, in the following situations:

- If a person's arms or legs are moving in the sensor detection range, e.g. when polishing the vehicle, sitting on the edge of the trunk, or picking up objects.
- If objects are moved or placed behind the vehicle, e.g. tensioning straps or luggage
- When working on the trailer coupling, trailers or rear bicycle racks.

Deactivate KEYLESS-GO (→ page 58) or do not carry the SmartKey about your person in such situations.

### Switching separate trunk locking on or off

If you centrally unlock the vehicle while separate locking is activated, the trunk remains locked.

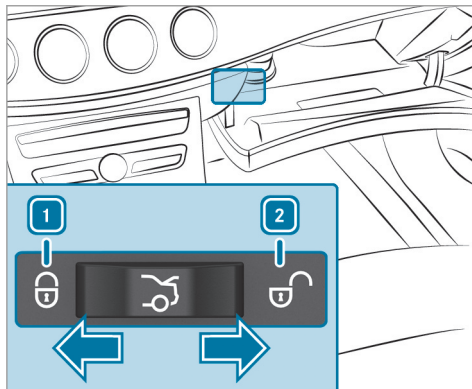

▶ **To switch on:** slide the switch to position **1**.

▶ **To switch off:** slide the switch to position **2**.

- ⓘ If an accident has been detected, the trunk unlocks even if separate locking is switched on.

### Unlocking the trunk with the emergency release from inside

#### Requirements

- The 12-V-vehicle battery is connected and charged.



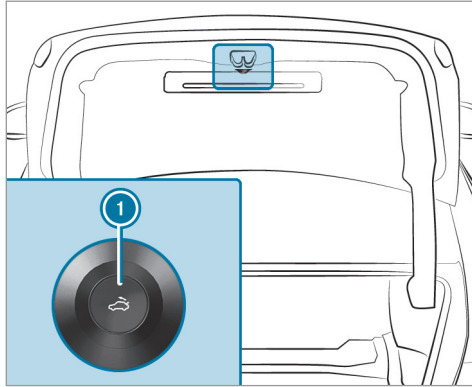

- ▶ Press emergency release button ① briefly. The trunk lid unlocks and opens.

### Activating/deactivating the trunk lid opening high restriction

Multimedia system:

→ Vehicle ▶  Vehicle Settings ▶ Trunk Lid Restriction

This function allows you to avoid bumping the trunk lid on a low garage ceiling, for example.

- ▶ Activate  or deactivate  the function.

### Side windows

#### Opening and closing the side windows

- ⚠ **WARNING** Risk of entrapment when opening a side window

When opening a side window, parts of the body could be drawn in or become trapped between the side window and window frame.

- ▶ When opening, make sure that nobody is touching the side window.

- ▶ If someone is trapped, release the button immediately or pull it in order to close the side window again.

- ⚠ **WARNING** Risk of becoming trapped when closing a side window

When closing a side window, body parts could be trapped in the closing area in the process.

- ▶ When closing, make sure that no body parts are in the closing area.
- ▶ If someone is trapped, release the button immediately or press the button in order to reopen the side window.

- ⚠ **WARNING** Risk of becoming trapped when children operate the side windows

Children could become trapped if they operate the side windows, particularly when unattended.

- ▶ Activate the child safety lock for the rear side windows.

## 72 Opening and closing

- ▶ When leaving the vehicle, always take the SmartKey with you and lock the vehicle.
- ▶ Never leave children unattended in the vehicle.

### Requirements

- The power supply or the ignition is switched on.

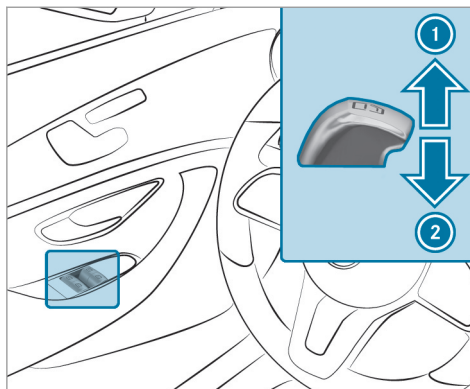

- ① Closes
- ② Opens

The buttons on the driver's door take precedence.

- ▶ **To start automatic operation:** press the  button beyond the point of resistance or pull and release it.

- ▶ **To interrupt automatic operation:** press or pull the  button again.

- ① Automatic operation for closing is available only for the front side windows.

When the vehicle is switched off, the side windows can continue being operated.

The function is available for around five minutes or until a door is opened.

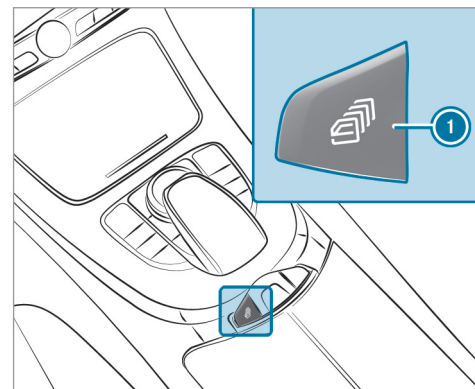

All side windows can be opened or closed simultaneously using button ①.

- ▶ Switch on the ignition.
- ▶ **To open:** press and hold button ① to the pressure point.
- ▶ **To open fully:** press and hold button ① beyond the pressure point.
- ▶ **To close:** pull and hold button ①.

#### Automatic reversing function of the side windows

If an object blocks a side window during the closing process, the side window opens again automatically. The automatic reversing function is only an aid and is not a substitute for your attentiveness.

- ▶ When closing, make sure that no body parts are in the closing area.

**⚠ WARNING** Risk of becoming trapped despite there being reversing protection on the side window

The reversing function does not react:

- to soft, light and thin objects, e.g. small fingers
- during resetting

This means that the reverse function cannot prevent someone from becoming trapped in these situations.

- ▶ When closing, make sure that no body parts are in the closing area.
- ▶ If someone becomes trapped, press the  button to open the side window again.

#### Convenience opening (ventilating the vehicle before starting a journey)

**⚠ WARNING** Risk of entrapment when opening a side window

When opening a side window, parts of the body could be drawn in or become trapped between the side window and window frame.

- ▶ When opening, make sure that nobody is touching the side window.
- ▶ Release the button immediately if somebody becomes trapped.

**⚠ WARNING** Risk of becoming trapped when opening/closing the soft top .

When opening or closing the soft top, there is a risk that parts of the body could become trapped by moving parts such as the roof mechanism, the trunk lid, or the side windows.

- ▶ When opening or closing, make sure that no body parts are in the vicinity of moving components.

- ▶ Release the button if somebody becomes trapped.

▶ Press and hold the  button on the SmartKey.

The following functions are performed:

- The vehicle is unlocked.
- The side windows are opened when the trunk partition is open.
- The soft top is opened when the trunk partition is closed.
- The seat ventilation of the driver's seat is switched on.

▶ **To interrupt convenience opening:** release the  button.

### Convenience closing (closing the vehicle from outside)

**⚠ WARNING** Risk of entrapment caused by inadvertent convenience closing

When the convenience closing feature is operating, parts of the body could become trapped in the closing area of the side windows.

- ▶ Observe the complete closing procedure when using convenience closing.
- ▶ When closing, make sure that no body parts are in the closing area.

**⚠ WARNING** Risk of becoming trapped when opening/closing the soft top .

When opening or closing the soft top, there is a risk that parts of the body could become trapped by moving parts such as the roof

mechanism, the trunk lid, or the side windows.

- ▶ When opening or closing, make sure that no body parts are in the vicinity of moving components.
- ▶ Release the button if somebody becomes trapped.

▶ Press and hold the  button on the SmartKey.

The following functions are performed:

- The vehicle is locked.
- The soft top is closed.

The side windows are closed when the soft top is closed.

▶ **To interrupt convenience closing:** release the  button.

**i** Convenience closing can also be operated with KEYLESS-GO (→ page 62).

## Problems with the side windows

Problem	Possible causes/consequences and ► Solutions
<p>A side window cannot be closed and you cannot see the cause.</p>	<ul style="list-style-type: none"> <li>► Check to see if any objects are in the window guide.</li> </ul> <div style="border: 1px solid #ccc; padding: 10px; margin: 10px 0;"> <p><b>⚠ WARNING</b> Risk of becoming trapped or fatally injured if reversing protection is not activated</p> <p>If you close a side window again immediately after it has been blocked or reset, the side window closes with increased or maximum force. The reversing feature is then not active.</p> <p>Parts of the body could become trapped in the closing area in the process.</p> <ul style="list-style-type: none"> <li>► Make sure that no parts of the body are in the closing area.</li> <li>► To stop the closing process, release the button or press the button again to reopen the side window.</li> </ul> </div> <ul style="list-style-type: none"> <li>► Close the soft top.</li> </ul> <p>If a side window is obstructed during closing and reopens again slightly:</p> <ul style="list-style-type: none"> <li>► Immediately after the window blocks, pull the corresponding button again until the side window has closed, and hold the button for an additional second. The side window is closed with increased force.</li> </ul> <p>If a side window is obstructed again during closing and reopens again slightly:</p> <ul style="list-style-type: none"> <li>► Repeat the previous step. The side window is closed without the automatic reversing function.</li> </ul>

Problem	Possible causes/consequences and ► Solutions
The side windows cannot be opened or closed using the convenience opening feature.	<p>The SmartKey battery is discharged or nearly discharged.</p> <p>► Check the battery using the battery check lamp and replace if necessary .</p>

### Soft top

#### Opening and closing the soft top using the soft-top switch

**⚠ WARNING** Risk of becoming trapped due to the soft top lowering unexpectedly

If you do not fully open/close the soft top, the soft-top hydraulics depressurize after a short time.

This causes the soft top to lower unexpectedly and may cause you or others to be trapped.

- Always fully open or close the soft top.

**⚠ WARNING** Risk of becoming trapped when opening/closing the soft top .

When opening or closing the soft top, there is a risk that parts of the body could become trapped by moving parts such as the roof mechanism, the trunk lid, or the side windows.

- When opening or closing, make sure that no body parts are in the vicinity of moving components.
- Release the button if somebody becomes trapped.

**! NOTE** Possible damage to the soft top when opening or closing

The soft top can be damaged when opening or closing.

- Make sure there is sufficient clearance above it.
- Only load the trunk below the trunk separator so that it will not be pushed upwards.
- Make sure that the trunk lid is closed.
- If the soft top is dirty, wet or frozen, do not open the soft top.

**!** **NOTE** Damage to the soft top caused by heavy objects

Heavy objects placed on the soft-top compartment cover can damage the soft top or soft-top compartment cover.

- ▶ Do not place heavy objects on the soft-top compartment cover.
- ▶ Do not sit on the soft-top compartment cover.

For safety reasons, Mercedes-Benz recommends opening or closing the soft top when the vehicle is stationary.

Do not exceed a maximum speed of 30 mph (50 km/h) when driving (max. 35 mph (60 km/h) to avoid interrupting the closing process in the event of slight excess speed).

- ▶ Make sure that the trunk separator is closed.
- ▶ Close the trunk lid.
- ▶ Switch on the ignition.
- ▶ Keep the brake pedal depressed when the vehicle is stationary.

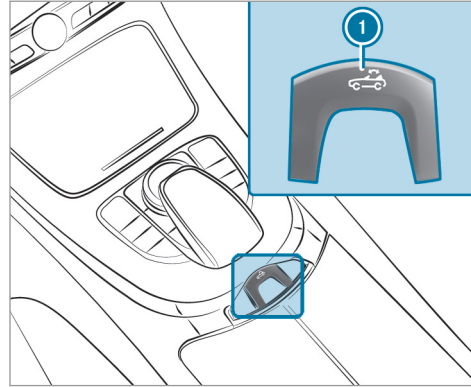

- ▶ **To open:** pull and hold soft-top switch ① until the soft top is fully opened. The multifunction display shows the opening process of the soft top.
- ▶ **To close:** press and hold soft-top switch ① until the soft top is fully closed. The multifunction display shows the closing process of the soft top.

**!** **WARNING** Risk of accident due to too high speed during the soft-top opening or closing procedure

If the vehicle speed exceeds 35 mph (60 km/h) the soft top stops during the opening or closing procedure.

This impairs your view to the rear.

- ▶ Reduce the vehicle speed to below 35 mph (60 km/h) or stop the vehicle, paying attention to road and traffic conditions.
- ▶ Operate the soft-top switch again in order to open or close the soft top fully.

The current procedure is stopped at a speed above 35 mph (60 km/h). The **Open/Close Convertible Top Completely** message is shown on the multifunction display.

- ▶ Reduce your speed and press or pull soft-top switch ① again.

If the soft top does not close fully because of strong headwinds, drive slower or stop.

### Relocking the soft top

**⚠ WARNING** Risk of becoming trapped due to the soft top lowering unexpectedly

If you do not fully open/close the soft top, the soft-top hydraulics depressurize after a short time.

This causes the soft top to lower unexpectedly and may cause you or others to be trapped.

- ▶ Always fully open or close the soft top.

If the soft top is not locked fully:

- The **Open/Close Convertible Top Completely** message is shown on the multifunction display.
- You will hear a warning tone for up to ten seconds when pulling away or while driving.
- ▶ Pull over and stop the vehicle safely as soon as possible, paying attention to road and traffic conditions.
- ▶ Switch on the ignition.

- ▶ Fully close the soft top using the soft-top switch.

### Opening and closing the trunk separator

The trunk separator covers luggage or loads in the trunk.

Depending on the equipment, the vehicle may be equipped with a manual or automatic trunk separator.

The soft top can be opened only when the manual trunk separator is closed.

In vehicles with an automatic trunk separator, this automatically closes when the soft top is opened.

**⚠ NOTE** Damage to the soft top or load

The soft top or load may be damaged with the soft top open.

- ▶ Do not place any overly long objects inside or behind the side parcel nets when the trunk separator is open.

- ▶ Make sure that the load does not push the trunk separator upwards.

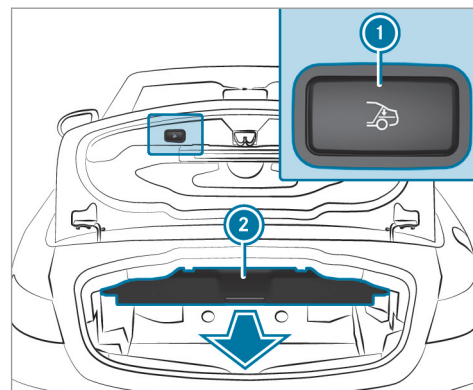

- ▶ **Vehicles with a manual trunk separator:** to open, push trunk separator ② by the handle against the direction of the arrow to its upper end position.



- ▶ **Vehicles with a manual trunk separator:** to close, pull trunk separator ② by the handle in the direction of the arrow until it rests on the sides of the trunk.
  - ▶ **Vehicles with an automatic trunk separator:** press button ①. Trunk separator ② opens or closes automatically.
- ① If there is system failure, the automatic trunk separator can be closed manually.

### Activating or deactivating AIRCAP

AIRCAP reduces the draft in the front and rear compartments when you are driving with the soft top open.

Particularly turbulent air can reduce the effect of AIRCAP. This can arise when you are driving behind another vehicle or if there is a crosswind, for example.

AIRCAP consists of the following components:

- a wind deflector above the windshield
- a draft stop behind both rear seat head restraints

When AIRCAP is activated, the wind deflector and the draft stop extend simultaneously. AIRCAP can be activated or deactivated at speeds of up to approximately 100 mph (160 km/h).

**⚠ WARNING** Risk of becoming trapped when retracting AIRCAP

When retracting AIRCAP, persons could become trapped in the moving mechanism.

- ▶ Make sure that persons do not hold onto the upper frame of the windshield and do not touch the AIRCAP wind deflector.

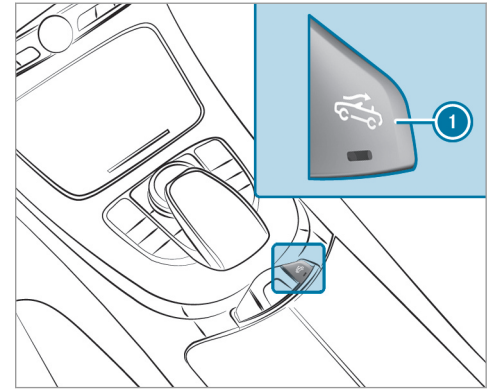

- ▶ Switch on the ignition.
- ▶ **To activate:** pull button ①. AIRCAP extends and the indicator lamp on button ① lights up.
- ▶ **To deactivate:** press button ①. AIRCAP retracts and the indicator lamp on button ① goes out.

If the vehicle is parked with the soft top open and the power supply is switched off, AIRCAP retracts automatically.

When you restart the engine after having been parked, AIRCAP extends automatically.

### Fitting and removing the folding draft stop

**⚠ WARNING** Risk of accident when using the wind screen in poor visibility conditions

The wind screen impairs your view to the rear, particularly when dark or in poor visibility conditions.

▶ Only use the wind screen in good visibility conditions.

**⚠ WARNING** Risk of accident and injury due to an incorrectly installed wind screen

If the wind screen is not correctly installed it can come loose during the journey and endanger other road users.

- ▶ Install the wind screen as described.
- ▶ Do not place objects on the installed wind screen.

**! NOTE** Damage to the folding wind screen or vehicle interior

The vehicle interior or the folding wind screen can be damaged if installed when the soft top is closed.

▶ To install, open the soft top.

**! NOTE** Front seat backrest position

The folding wind screen may collide with the front seat backrests when installed.

▶ Adjust the backrest positions of the front seats.

The folding draft stop is fitted over the rear seats to protect against wind when driving with the soft top open. Only the front seats can be occupied when the folding draft stop is installed.

The bag containing the folding draft stop is attached to the through-loading feature behind the rear seats. If you want to use the through-loading feature, loosen the bag's lashing straps and stow them in the trunk. Fasten the lashing straps to the luggage hook.

You should preferably perform operations involving the folding draft stop on the side facing away from traffic.

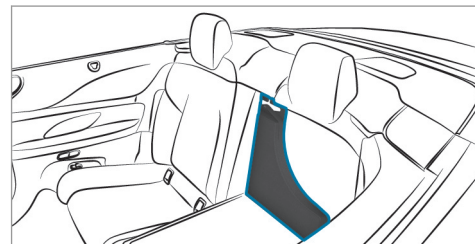

- ▶ Open all side windows and the soft top.
- ▶ Fold the rear seats forward to remove the bag.
- ▶ Remove the folding draft stop from the bag.



- ▶ Fold out folding draft stop ① as shown.
- ▶ Fold out the two brackets ② to the left and right.

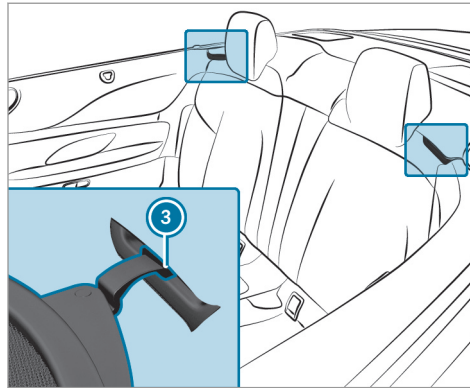

- ▶ Align brackets ② of folding draft stop ① with two rear fixtures ③ on the vehicle.

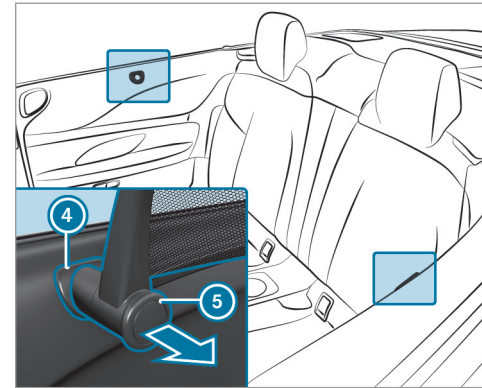

Perform the following steps in sequence on both sides of the vehicle:

- ▶ Pull handle ⑤ in the direction of the arrow.
- ▶ Align folding draft stop ① with side fixture ④ on the vehicle from above and insert.
- ▶ Push handle ⑤ on folding draft stop ① back as far as it will go. Folding draft stop ① is locked.

## 82 Opening and closing

Follow the instructions in reverse order to remove the folding draft stop.

### Problems with the soft top

Problem	Possible causes/consequences and ► Solutions
The soft top will not open or close.	The ignition is not switched on. ► Make sure that the ignition is switched on.
	The trunk lid is open. ► Closing the trunk lid .
	The trunk separator is not closed. ► Remove overhanging luggage and close the trunk separator.
	The mechanical soft-top components or control system are defective. ► Visit a qualified specialist workshop.
	The soft top has been opened and closed several times in a row. The soft-top drive has been switched off automatically and will be available again after approximately ten minutes. ► Repeat the opening or closing procedure after approximately ten minutes.

## Anti-theft protection

### Function of the immobilizer

The immobilizer prevents your vehicle from being started without the correct SmartKey.

The immobilizer is automatically activated when the ignition is switched off and deactivated when the ignition is switched on.

When leaving the vehicle, always take the SmartKey with you and lock the vehicle. Anyone can start the engine if a valid SmartKey has been left inside the vehicle.

- ❗ In the event the engine cannot be started (yet the vehicle's starter battery is charged), the system is not operational. Contact an authorized Mercedes-Benz Center or call 1-800-FOR-MERCEdes (in the USA) or 1-800-387-0100 (in Canada).

### ATA (anti-theft alarm system)

#### Function of the ATA system

If the ATA system is armed, a visual and audible alarm is triggered in the following situations:

- When a door is opened
- When the trunk lid is opened
- When the hood is opened

The ATA system is armed automatically after approximately 10 seconds:

- After locking the vehicle with the SmartKey.
- After locking the vehicle using KEYLESS-GO.

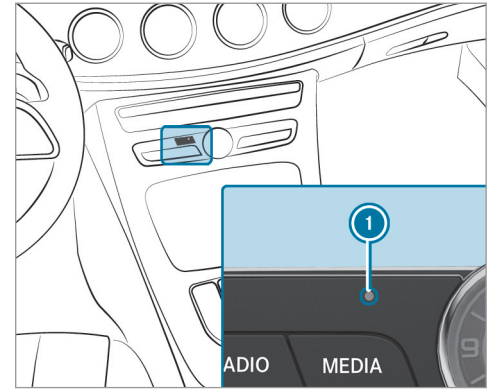

Indicator lamp ❶ flashes when the ATA system is activated.

The ATA system is automatically deactivated:

- After unlocking the vehicle with the SmartKey
- After pressing the start/stop button with the SmartKey in the stowage compartment (→ page 132)

## 84 Opening and closing

---

- After unlocking the vehicle using KEYLESS-GO.
- ① When the mbrace service (→ page 283) is active and the alarm stays on for more than 30 seconds, a message is automatically sent to the Customer Assistance Center.

### Deactivating the ATA

▶ Press the ,  or  button on the SmartKey.

or

▶ Press the start/stop button with the SmartKey in the stowage compartment (→ page 132)

### Deactivating the alarm using KEYLESS-GO:

▶ Grasp the outside door handle with the SmartKey outside the vehicle.

### Notes on the correct driver's seat position

**⚠ WARNING** Risk of injury from adjusting the vehicle settings while the vehicle is in motion

You could lose control of the vehicle in the following situations:

- if you adjust the driver's seat, the head restraint, the steering wheel or the mirror while the vehicle is in motion
- if you fasten your seat belt while the vehicle is in motion

▶ Before starting the engine: adjust the driver's seat, the head restraint, the steering wheel or the mirror and fasten your seat belt.

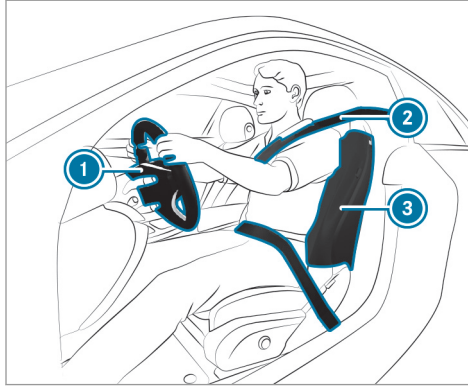

Ensure the following when adjusting the steering wheel ①, seat belt ② and driver's seat ③:

- you are as far away from the driver's airbag as possible
- you are sitting in a normal upright position
- your thighs are slightly supported by the seat cushion

- your legs are not entirely stretched and you can depress the pedals properly
- the back of your head is supported at eye level by the center of the head restraint
- you can hold the steering wheel with your arms slightly bent
- you can move your legs freely
- you can see all the displays on the instrument cluster clearly
- you have a good overview of the traffic conditions
- the seat belt is pulled snugly against the body and is routed across the center of your shoulder and across your hips in the pelvic area

## Seats

### Adjusting the front seat mechanically and electrically

**⚠ WARNING** Risk of becoming trapped if the seats are adjusted by children

Children could become trapped if they adjust the seats, particularly when unattended.

- ▶ When leaving the vehicle, always take the SmartKey with you and lock the vehicle.
- ▶ Never leave children unattended in the vehicle.

The seats can be adjusted when the ignition is switched off.

**⚠ WARNING** Risk of becoming trapped when adjusting the seats

When you adjust a seat, you or other vehicle occupants could become trapped, e.g. on the seat guide rail.

- ▶ Make sure when adjusting a seat that no one has any body parts in the sweep of the seat.

Observe the safety notes on "Air bags" and "Children in the vehicle".

**⚠ WARNING** Risk of accident due to the driver's seat not being engaged

If the driver's seat is not engaged, it could move unexpectedly while the vehicle is in motion.

This could cause you to lose control of the vehicle.

- ▶ Always make sure that the driver's seat is engaged before starting the vehicle.

**⚠ WARNING** Risk of becoming trapped if the seat height is adjusted carelessly

If you adjust the seat height carelessly, you or other vehicle occupants could be trapped and thereby injured.

Children in particular could accidentally press the electrical seat adjustment buttons and become trapped.

- ▶ While moving the seats, make sure that hands or other body parts do not get under the lever assembly of the seat adjustment system.

**⚠ WARNING** Risk of injury due to head restraints which are not installed or are adjusted incorrectly

If head restraints are not installed or are adjusted incorrectly, the head restraints cannot provide protection as intended.

There is an increased risk of injury in the head and neck area, e.g. in the event of an accident or when braking.

- ▶ Always drive with the head restraints installed.
- ▶ Before driving off, make sure for every vehicle occupant that the center of the head restraint supports the back of the head at about eye level.



Do not interchange the head restraints of the front and rear seats. Otherwise, you cannot adjust the height and angle of the head restraints correctly.

Adjust the head restraint fore-and-aft position so that it is as close as possible to the back of your head.

**⚠ WARNING** Risk of injury or death due to incorrect seat position

The seat belt does not offer the intended level of protection if you have not moved the seat backrest to an almost vertical position.

When braking or in the event of an accident, you could slide underneath the seat belt and sustain abdominal or neck injuries, for example.

- ▶ Adjust the seat properly before beginning your journey.
- ▶ Always ensure that the seat backrest is in an almost vertical position and that the shoulder section of your seat belt is routed across the center of your shoulder.

**! NOTE** Damage to the seats when moving the seats back

The seats may be damaged by objects when moving the seats back.

- ▶ When moving the seats back, make sure that there are no objects in the footwell or under or behind the seats.

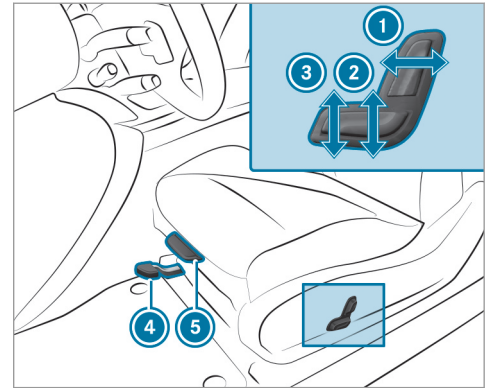

- ① Seat backrest inclination
- ② Seat height
- ③ Seat cushion inclination
- ④ Seat fore-and-aft position
- ⑤ Seat cushion length

- ▶ **To adjust the seat fore-and-aft position:** lift lever ④ and slide the seat forwards- or backwards.

- ▶ Make sure that the seat is engaged.
- ▶ **To adjust the seat cushion length:** lift lever ⑤ and slide the front section of the seat cushion forwards or backwards.

### Adjusting the front seat electrically

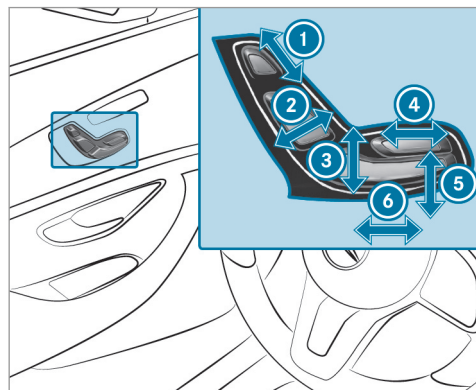

- ① Head restraint height
- ② Seat backrest inclination

- ③ Seat height
- ④ Seat cushion length
- ⑤ Seat cushion inclination
- ⑥ Seat fore-and-aft adjustment

- ▶ Save the settings with the memory function (→ page 98).

### Adjusting the front passenger seat from the driver's seat electrically

#### Requirements:

- The power supply is switched on.

This function is only available on vehicles with an electrically adjustable front passenger seat.

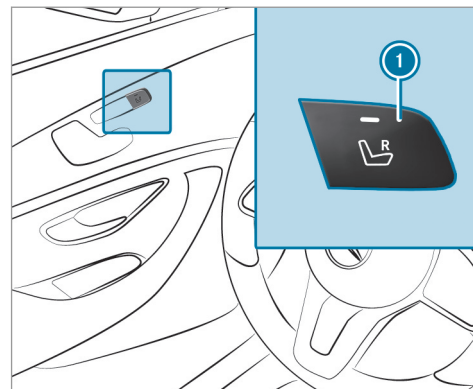

You can call up the following functions for the front passenger seat:

- Seat adjustment
- Seat heating
- Seat ventilation
- Memory function

- ▶ **To select the front passenger seat:** press button ①. When the indicator lamp lights up, the front passenger seat is selected.
- ▶ Adjust the front passenger seat using the buttons in the door control panel on the driver's side.

### Adjusting the 4-way lumbar support

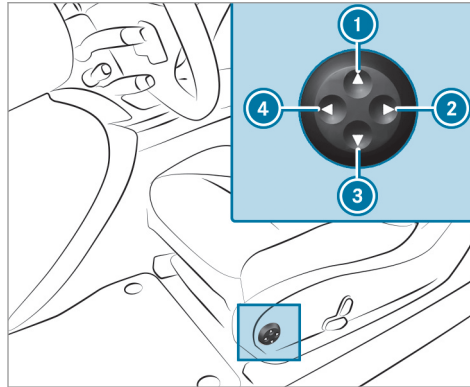

- ① To raise
- ② To soften
- ③ To lower
- ④ To harden

- ▶ Using buttons ① to ④, adjust the contour of the backrest individually to suit your back.

### Head restraints

#### Adjusting the head restraints on the front seats

**⚠ WARNING** Risk of injury from adjusting the vehicle settings while the vehicle is in motion

You could lose control of the vehicle in the following situations:

- if you adjust the driver's seat, the head restraint, the steering wheel or the mirror while the vehicle is in motion
- if you fasten your seat belt while the vehicle is in motion

- ▶ Before starting the engine: adjust the driver's seat, the head restraint, the steering wheel or the mirror and fasten your seat belt.

**⚠ WARNING** Risk of injury due to head restraints which are not installed or are adjusted incorrectly

If head restraints are not installed or are adjusted incorrectly, the head restraints cannot provide protection as intended.

There is an increased risk of injury in the head and neck area, e.g. in the event of an accident or when braking.

- ▶ Always drive with the head restraints installed.
- ▶ Before driving off, make sure for every vehicle occupant that the center of the head restraint supports the back of the head at about eye level.

Do not interchange the head restraints of the front and rear seats. Otherwise, you cannot adjust the height and angle of the head restraints correctly.

Adjust the head restraint fore-and-aft position so that it is as close as possible to the back of your head.

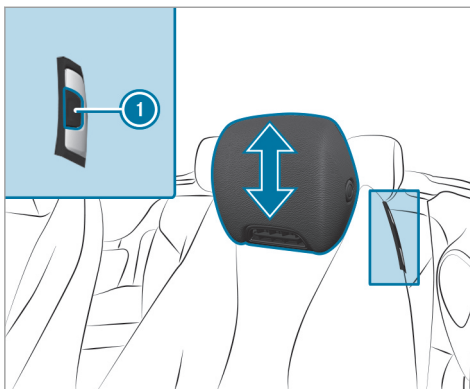

- ▶ **To raise:** pull the head restraint up.
- ▶ **To lower:** press release knob ① and push the head restraint down.

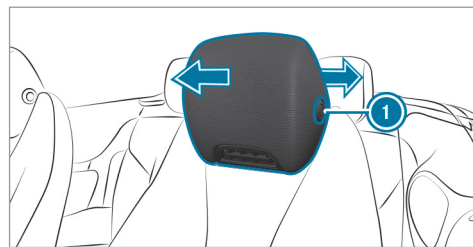

- ▶ **To move forwards:** pull the head restraint forwards.
- ▶ **To move backwards:** press release knob ① and push the head restraint backwards.

## Installing/removing the rear seat head restraints

### Removing

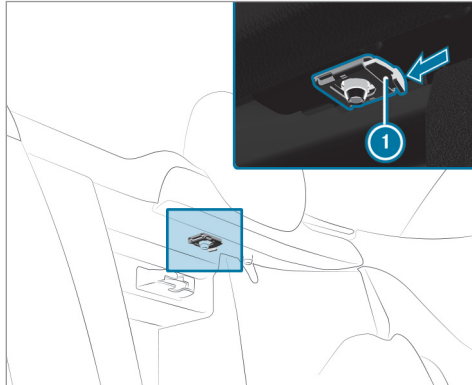

- ▶ Release the rear seat backrest and fold it slightly forwards (→ page 101).
- ▶ Push release knob ① in the direction of the arrow and pull out the head restraint.

### Installing

- ▶ Insert the head restraint such that the notches on the bar are on the left when viewed in the direction of travel.
- ▶ Push the head restraint down until you hear it engage in position.
- ▶ Fold the rear seat backrest back until it engages.

## Configuring seat settings

Multimedia system:

↳ Vehicle ▶ Seats

- ▶ Select **Driver's Seat** or **Passenger Seat**.

### Adjusting the backrest side bolsters

- ▶ Select **Side Bolsters**.
- ▶ Select the setting.

### Adjusting the seat contour in the lumbar region of the seat backrest

- ▶ Select **Lumbar**.
- ▶ Adjust the air cushion.

### Memory function

- ▶ Save the seat settings with the memory function (→ page 98).

## Overview of message programs

### Message programs

The following programs can be selected:

- **Relaxing Message**
- **Activating Message**
- **Classic Message**
- **Mobilizing Message**

## Selecting the message program for the front seats

Multimedia system:

↳ Vehicle ▶ Seats

- ▶ Select **Driver's Seat** or **Front Passenger**.
- ▶ Select **Message**.

- ▶ Select a massage program.  
The massage program runs for approximately 9 to 22 minutes, depending on the setting.
- ▶ To set the massage intensity: switch **High Intensity** on  or off .

### Resetting seat and massage settings

Multimedia system:

→ Vehicle →  Seats → Reset

- ▶ Select **Yes** or **No**.

Depending on whether the settings for the driver or front passenger seat are selected, only the selected seat can be reset.

### Folding the front seat backrest forwards/back (vehicles with memory function)

With the EASY-ENTRY function, the seat moves forwards if you have folded the seat backrest forwards. This makes it easier for passengers to get into and out of the rear of the vehicle.

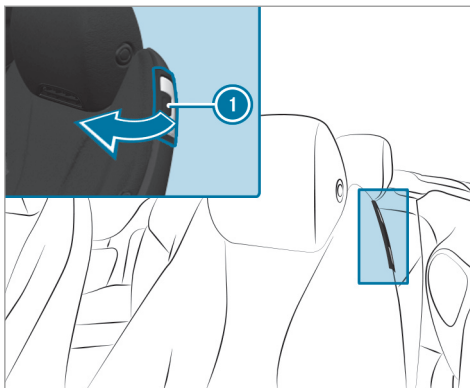

- ▶ **To fold forwards:** pull seat release handle ① and fold the seat backrest forwards as far as it will go.  
The seat moves automatically to the foremost position.
- ▶ **To fold back:** swing back the seat backrest horizontally.  
If the seat backrest is not engaged, this will be shown on the multifunction display of the

instrument cluster. A warning tone also sounds.

The seat moves automatically to the stored position.

If the previous seat position can no longer be set, e.g. because of luggage in the rear footwell or after occupants have entered the rear of the vehicle:

- ▶ Pull seat release handle ① again and return the seat backrest to an upright position.  
The seat locks in the new fore-and-aft adjustment position.

### Switching the seat heating on/off

**⚠ WARNING** Risk of burns due to repeatedly switching on the seat heater

Repeatedly switching on the seat heater can cause the seat cushion and seat backrest padding to become very hot.

The health of persons with limited temperature sensitivity or a limited ability to react to excessively high temperatures may be affected or they may even suffer burn-like injuries.

- ▶ Do not repeatedly switch on the seat heater.

**!** **NOTE** Damage to the seats caused by objects or documents when the seat heater is switched on

When the seat heater is switched on, overheating can occur due to objects or documents placed on the seats e.g. seat cushions or child seats. This could cause damage to the seat surface.

- ▶ Make sure that no objects or documents are on the seats when the seat heater is switched on.

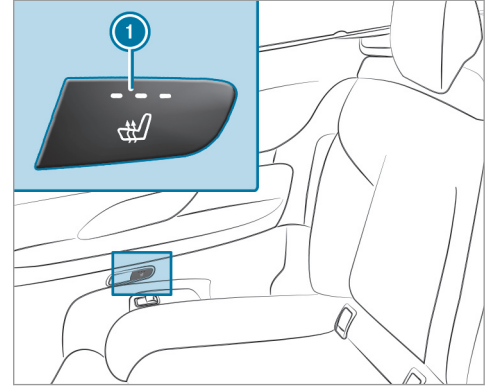
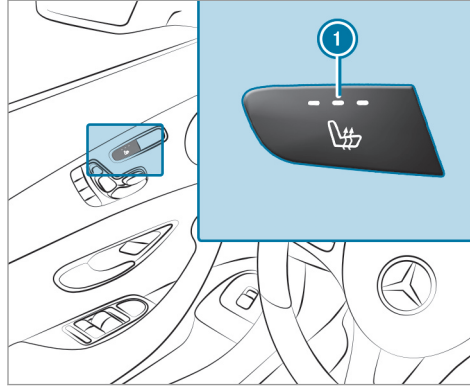

### Requirements

- The power supply is switched on.

- ▶ **To switch on/increase the level:** press button ① repeatedly until the desired heating level is set. Depending on the heating level, up to three indicator lamps light up.

▶ **To switch off/reduce the level:** press button ❶ repeatedly until the desired heating level is set.

If all indicator lamps are off, the seat heating is switched off.

❶ The seat heating automatically switches down from the three heating levels after 8, 10 and 20 minutes until the seat heating is switched off.

### Setting the panel heating

Multimedia system:

➔ Vehicle ▶▶  Vehicle Settings ▶▶ Panel Heating

When the seat heater is switched on, the armrests in the vehicle as well as the center console can be heated using this function.

#### Setting options

▶ Select **Front Only** or **Off**.

### Switching the seat ventilation on/off

#### Requirements:

- The power supply is switched on.

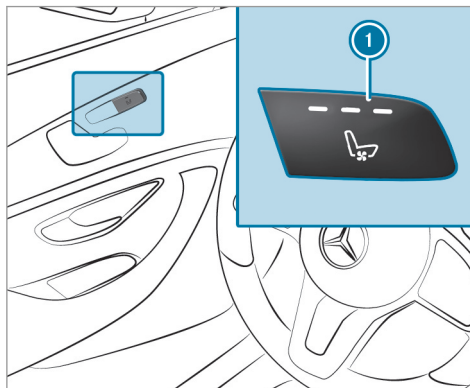

▶ **To switch on/increase the level:** press button ❶ repeatedly until the desired ventilation level is set.

Depending on the ventilation level, up to three indicator lamps light up.

▶ **To switch off/reduce the level:** press button ❶ repeatedly until the desired ventilation level is set.

If all indicator lamps are off, the seat ventilation is switched off.

### Switching AIRSCARF on/off

**⚠ WARNING** Risk of burns caused by the heating output from AIRSCARF being too high

When AIRSCARF is switched on, very hot air can flow from the outlet opening in the head restraints.

This could result in burns in the immediate vicinity of the outlet opening.

- ▶ Turn the heating output down in good time.
- ▶ Maintain a suitable distance from the outlet opening.

#### Requirements

- The power supply is switched on.



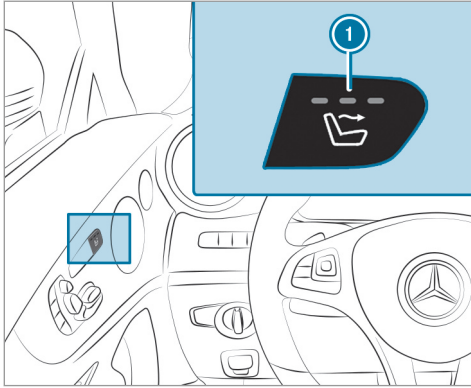

AIRSCARF warms the head and neck area of vehicle occupants with warm air. The warm air flows out of the vents in the head restraints.

- ▶ **To switch on/increase the level:** press button ① repeatedly until the desired heating level is set. Depending on the heating level, up to three indicator lamps light up.

- ▶ **To switch off/reduce the level:** press button ① repeatedly until the desired heating level is set. If all of the indicator lamps are off, AIRSCARF is switched off.
- ① When switching on, the blower starts up only after a preheating phase which lasts a few seconds. After switching off, the blower runs on for a few seconds to cool down the heating elements.
- ① If the vehicle battery voltage is too low, AIRSCARF may switch off.
- ▶ Adjusting the AIRSCARF vent (→ page 130).

Make sure that there are no objects covering the intake grille on the back of the head restraint.

## Steering wheel

### Adjusting the steering wheel manually

- ⚠ **WARNING** Risk of injury from adjusting the vehicle settings while the vehicle is in motion

You could lose control of the vehicle in the following situations:

- if you adjust the driver's seat, the head restraint, the steering wheel or the mirror while the vehicle is in motion
- if you fasten your seat belt while the vehicle is in motion

- ▶ Before starting the engine: adjust the driver's seat, the head restraint, the steering wheel or the mirror and fasten your seat belt.

- ⚠ **WARNING** Risk of entrapment for children when adjusting the steering wheel

Children could injure themselves if they adjust the steering wheel.

- ▶ Never leave children unattended in the vehicle.
- ▶ When leaving the vehicle, always take the SmartKey with you and lock the vehicle.

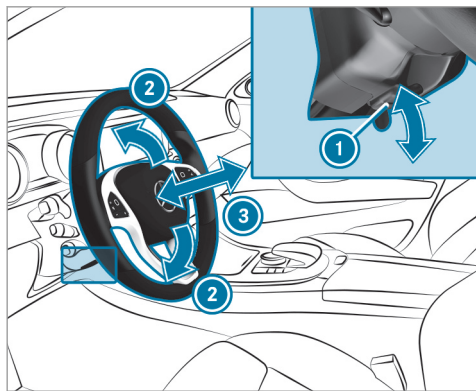

- ▶ Push release lever ① down as far as it will go. The steering column is unlocked.

- ▶ Adjust height ② and distance ③ to the steering wheel.
- ▶ Push release lever ① up as far as it will go. The steering column is locked.
- ▶ Check and make sure that the steering column is locked by moving the steering wheel.

#### Adjusting the steering wheel electrically

The steering wheel can be adjusted when the power supply is switched off.

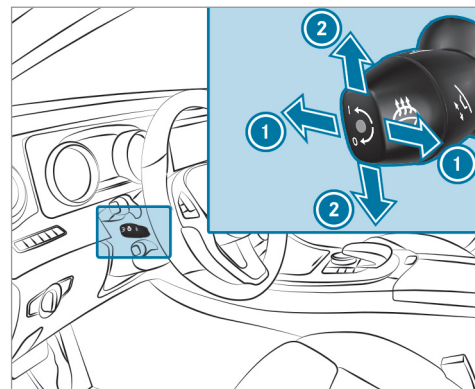

- ① Adjusts the distance to the steering wheel
- ② Adjusts the height
- ▶ Save the settings with the memory function (→ page 98).

## Switching the steering wheel heater on/off

### Requirements

- The power supply or the ignition is switched on.

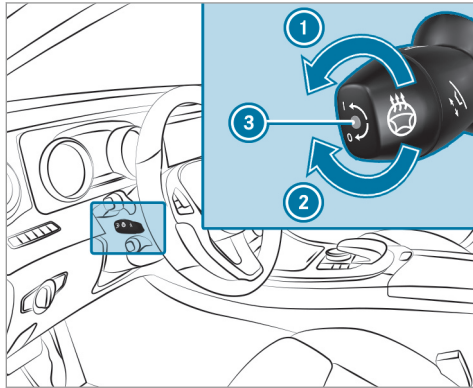

- ▶ **To switch on/off:** turn the lever in the direction of arrow ① or ②. If indicator lamp ③ lights up, the steering wheel heater is switched on.

## Easy entry and exit feature

### Function of the easy entry and exit feature

**⚠ WARNING** Risk of accident when driving off while adjusting the easy exit feature

- If you drive off while the easy entry and exit feature is making adjustments, you could lose control of the vehicle.

- ▶ Always wait until the adjustment process is complete before driving off.

**⚠ WARNING** Risk of entrapment when adjusting the easy entry and exit feature

- When the easy entry and exit feature adjusts the steering wheel, you and other vehicle occupants - particularly children - could become trapped.

- ▶ - While the easy entry and exit feature is making adjustments, make sure that no one has any body parts in the sweep of the steering wheel.

- ▶ Move the adjustment lever of the steering wheel if there is a risk of becoming trapped by the steering wheel. The adjustment process is stopped.
- ▶ Never leave children unattended in the vehicle.
- ▶ When leaving the vehicle, always take the key with you and lock the vehicle.

**Vehicles with memory function:** you can stop the adjustment process by pressing one of the memory position buttons of the memory function.

If the easy entry and exit feature is active, the steering wheel will move upwards in the following situations:

- You switch the ignition off.
- You open the driver's door when the ignition is switched on.

The steering wheel moves back to the last drive position in the following cases:

- You switch the ignition on when the driver's door is closed.

- You close the driver's door when the ignition is switched on.

The last drive position of the steering wheel is stored in the following situations:

- You switch the ignition off.
- **Vehicles with memory function:** save the seat settings via the memory function.

**Vehicles with memory function:** press one of the memory function saved position buttons to stop the adjustment process.

### Setting the easy entry and exit feature

Multimedia system:

→ Vehicle →  Vehicle Settings → Easy Entry/Exit

- ▶ Select **Steering Wheel Only** or **Off**.

### Using the memory function

**⚠ WARNING** Risk of an accident if memory function is used while driving

If you use the memory function on the driver's side while driving, you could lose control of the vehicle as a result of the adjustments being made.

- ▶ Only use the memory function on the driver's side when the vehicle is stationary.

**⚠ WARNING** Risk of entrapment when setting the seat with the memory function

When the memory function adjusts the seat or steering wheel, you and other vehicle occupants – particularly children – could become trapped.

- ▶ During the setting procedure of the memory function, ensure that no body parts are in the sweep of the seat or the steering wheel.

- ▶ If somebody becomes trapped, immediately release the memory function position button.  
The adjustment process is stopped.

**⚠ WARNING** Risk of entrapment if the memory function is activated by children

Children could become trapped if they activate the memory function, particularly when unattended.

- ▶ Never leave children unattended in the vehicle.
- ▶ When leaving the vehicle, always take the key with you and lock the vehicle.

The memory function can be used when the ignition is switched off.

### Storing

Seat adjustments for up to three people can be stored and called up using the memory function.

The following systems can be selected:

- Seat, backrest and head restraint

- Steering wheel
- Outside mirrors
- Head-up Display

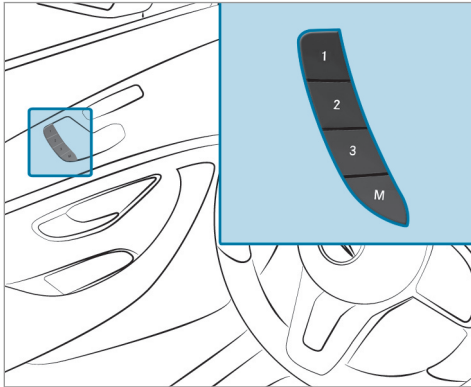

- ▶ Set the seat, the steering wheel, the head-up display and the outside mirror to the desired position.

- ▶ Press memory button M together with one of the memory position switches 1, 2 or 3. An acoustic signal sounds. The settings are stored.
- ▶ **To call up:** press and hold the relevant pre-set position button 1, 2 or 3 until the front seat, the steering wheel, Head-up Display and outside mirror is in the stored position.

### Stowage areas

#### Notes on loading the vehicle

#### **⚠ WARNING** Risk of exhaust gas poisoning

Combustion engines emit poisonous exhaust gases such as carbon monoxide. Exhaust gases can enter the vehicle interior if the trunk lid is open when the engine is running, especially if the vehicle is in motion.

- ▶ Always switch off the engine before opening the trunk lid.
- ▶ Never drive with the trunk lid open.

#### **⚠ WARNING** Risk of injury from unsecured items in the vehicle

If objects, luggage or loads are not secured or not secured sufficiently, they could slip, tip over or be thrown around and thereby hit vehicle occupants.

There is a risk of injury, particularly in the event of sudden braking or a sudden change in direction.

- ▶ Always stow objects in such a way that they cannot be thrown around.
- ▶ Before the journey, secure objects, luggage or loads against slipping or tipping over.

#### **⚠ WARNING** Risk of injury from incorrectly stowed objects

If objects in the vehicle interior are stowed incorrectly, they can slide or be thrown around and hit vehicle occupants. In addition, cup holders, open stowage spaces and mobile phone brackets cannot always retain all objects they contain.

There is a risk of injury, particularly in the event of sudden braking or a sudden change in direction.

- ▶ Always stow objects so that they cannot be thrown around in such situations.
- ▶ Always make sure that objects do not protrude from stowage spaces, luggage nets or stowage nets.
- ▶ Close the lockable stowage spaces before starting a journey.
- ▶ Always stow and secure heavy, hard, pointed, sharp-edged, fragile or bulky objects in the trunk.

**⚠ WARNING** Risk of burns from tailpipes and tailpipe trim

The tailpipe and tailpipe trim can become very hot. If you come into contact with these parts of the vehicle, you could burn yourself.

- ▶ Always be particularly careful around the tailpipe and the tailpipe trim.

- ▶ Allow the vehicle parts to cool down before you touch them.

The handling characteristics of your vehicle are dependent on the distribution of the load within the vehicle. You should bear the following in mind when loading the vehicle:

- never exceed the permissible gross mass or the permissible axle loads for the vehicle (including occupants). The values are specified on the vehicle identification plate on the vehicle's B-pillar.
- the load must not protrude above the upper edge of the seat backrests.
- always place the load behind unoccupied seats if possible.
- secure the load using the tie-down eyes and distribute the load evenly.

## Stowage spaces in the vehicle interior

### Overview of the front stowage compartments

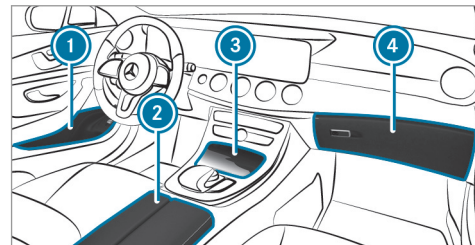

- 1 Stowage compartment in the doors
- 2 Stowage/telephone compartment in the armrest with multimedia connections and stowage compartment, e.g. for an MP3 player
- 3 Stowage compartment in the front center console with a USB port (depending on the vehicle's equipment)
- 4 Glove box

### Locking or unlocking the glove box

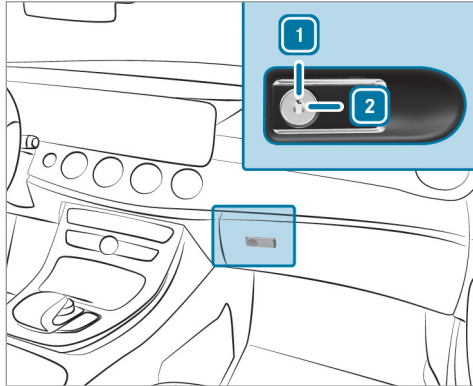

- ▶ Turn the mechanical key a quarter turn clockwise **2** (to lock) or counter-clockwise **1** (to unlock).

### Opening the spectacles compartment

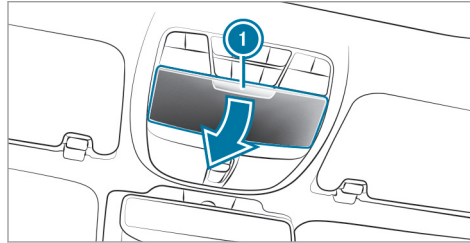

- ▶ Press button **1**.

### Rear bench seat through-loading feature

#### Folding the rear seat backrest forwards

**⚠ WARNING** Risk of injury if the rear bench seat/rear seat and seat backrest are not engaged

If the rear bench seat/rear seat and seat backrest are not engaged they could fold forwards, e.g. when braking suddenly or in the event of an accident.

- If this is the case, the vehicle occupant would be forced into the seat belt by the rear bench seat/rear seat or by the seat backrest. The seat belt cannot protect as intended and could result in additional injury.
- Objects or loads in the trunk cannot be restrained by the seat backrest.
- ▶ Make sure that the seat backrest and the rear bench seat/rear seat are engaged before every trip.

Both seat backrests can be folded forwards separately.

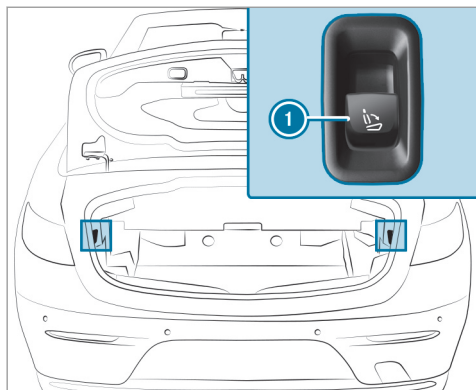

- ▶ Pull button ①.
- ▶ Fold the corresponding seat backrest forwards.

### Folding the rear seat backrest back

**!** **NOTE** Damage to the seat belt

The seat belt could become trapped and thus damaged when folding back the seat backrest.

- ▶ Make sure that the seat belt is not trapped when folding back the seat backrest.
- ▶ Move the driver's or front passenger seat forwards, if necessary.

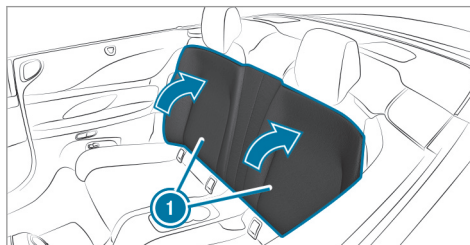

- ▶ Fold corresponding seat backrest ① back until it engages.  
If the seat backrest is not engaged and locked, this will be shown in the multifunction display in the instrument cluster.

### Overview of the tie-down eyes

Observe the notes on loading the vehicle (→ page 99).



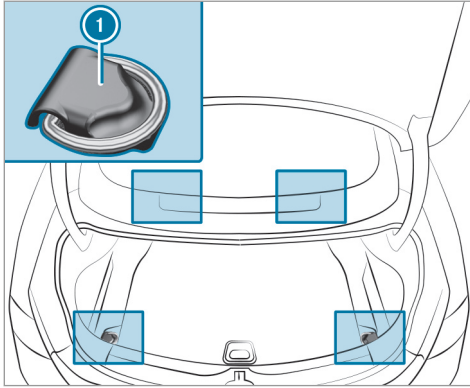

### 1 Tie-down eyes

Vehicles with a wind screen: there is an additional tie-down eye behind the rear bench seat backrests. To access this, the seat backrests must be folded down (→ page 101).

### Overview of bag hooks

**⚠ WARNING** Risk of injury when using bag hooks with heavy objects

The bag hooks cannot restrain heavy objects or items of luggage.

Objects or items of luggage could be thrown around and thereby hit vehicle occupants when braking or abruptly changing directions.

- ▶ Only hang light objects on the bag hooks.
- ▶ Never hang hard, sharp-edged or fragile objects on the bag hooks.

The bag hook can bear a maximum load of 2.2 lbs (1 kg). Do not use it to secure cargo.

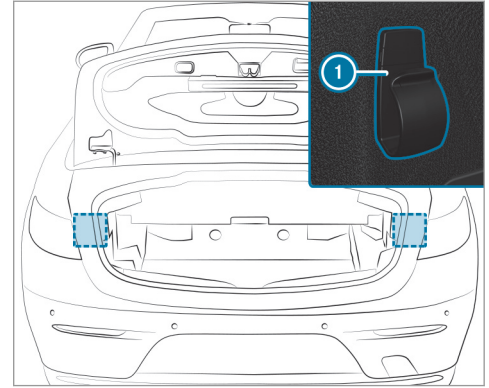

### 1 Bag hook

i Observe the notes on loading the vehicle (→ page 99).

### Hooking the luggage net

**⚠ WARNING** Risk of injury from incorrectly stowed objects

If objects in the vehicle interior are stowed incorrectly, they can slide or be thrown around and hit vehicle occupants. In addition, cup holders, open stowage spaces and mobile phone brackets cannot always retain all objects they contain.

There is a risk of injury, particularly in the event of sudden braking or a sudden change in direction.

- ▶ Always stow objects so that they cannot be thrown around in such situations.
- ▶ Always make sure that objects do not protrude from stowage spaces, luggage nets or stowage nets.
- ▶ Close the lockable stowage spaces before starting a journey.

- ▶ Always stow and secure heavy, hard, pointed, sharp-edged, fragile or bulky objects in the trunk.

Observe the notes on loading the vehicle.

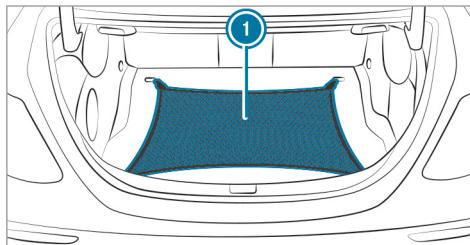

- ▶ Fold up the tie-down eyes.
- ▶ Hook luggage net ① into the front and rear tie-down eyes.

### Opening the stowage space under the trunk floor

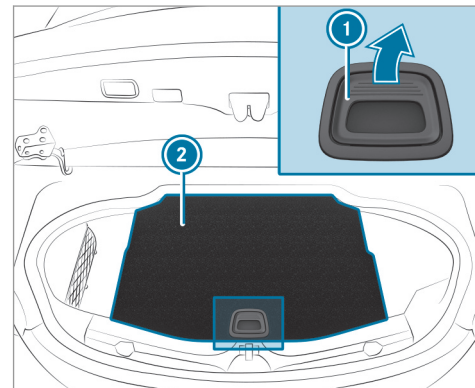

- ▶ Pull trunk floor ② upwards using handle ① until it rests against the trunk separator.

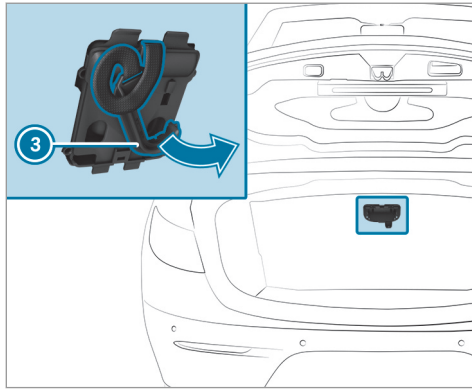

- ▶ Fold out hook ③ on the underside of the trunk floor.

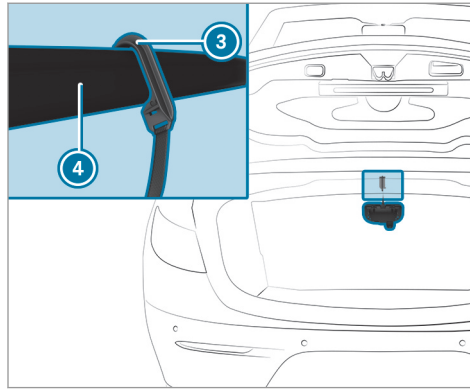

- ▶ Clip hook ③ onto drip rail ④.

### Cup holder

#### Installing the cup holder in or removing it from the center console (automatic transmission)

**⚠ WARNING** - Risk of accident or injury when using the cup holder while the vehicle is moving

The cup holder cannot secure containers while the vehicle is moving.

If you use a cup holder while the vehicle is moving, the container may be flung around and liquids may be spilled. The vehicle occupants may come into contact with the liquid and if it is hot, they could be scalded. You could be distracted from traffic conditions and you may lose control of the vehicle.

- ▶ Only use the cup holder when the vehicle is stationary.
- ▶ Only use the cup holder for containers of the right size.
- ▶ Close the container, particularly if the liquid is hot.

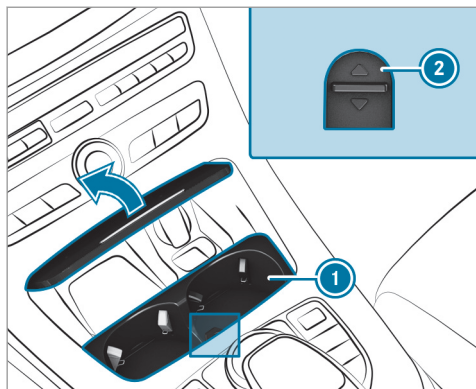

### Function of the cup holder in the rear bench seat

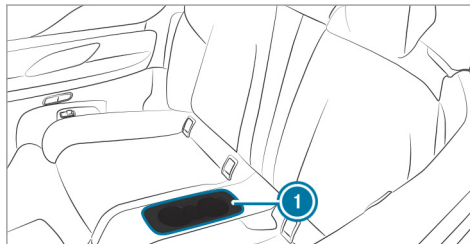

There is room for two cups of up to 17 fl. oz. (0.5 l) in cup holder ①.

▶ **To remove:** slide catch ② forwards and pull out cup holder ①.

▶ **To install:** insert cup holder ① and slide back catch ②.

① The cup holder rubber mat can be removed for cleaning, e.g. using clean, lukewarm water.

### Ashtray and cigarette lighter

#### Using the ashtray in the front center console

! **NOTE** Damage to the stowage compartment under the ashtray

The stowage compartment under the ashtray is not heat resistant and could be damaged if you rest a lit cigarette on it.

▶ Make sure that the ashtray is fully engaged.

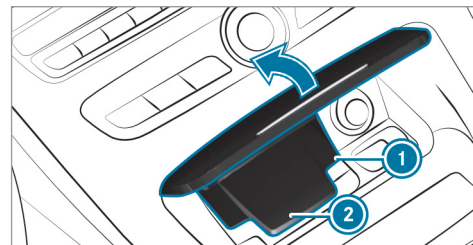

▶ **To open:** push up the cover ② of the ashtray on its right or left side.

- ▶ **To remove the insert:** press insert ① upwards slightly and pull it out upwards.
- ▶ **To refit the insert:** press insert ① into the holder until it engages.

### Using the rear ashtray

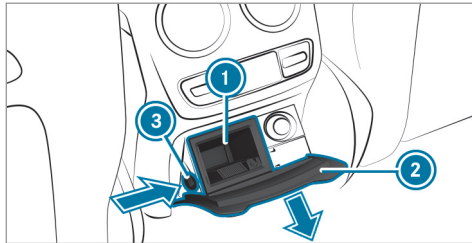

- ▶ **To open:** pull cover ② out by its top handle edge.
- ▶ **To remove the insert:** push ribbing ③ from the left side and pull insert ① upwards and out.

- ▶ **To install the insert:** install insert ① from above and press down into the holder until it engages.

### Using the cigarette lighter

**⚠ WARNING** - Risk of fire and injury from hot cigarette lighter

You can burn yourself if you touch the hot heating element or the socket of the cigarette lighter.

In addition, flammable materials may ignite if:

- you drop the hot cigarette lighter
- a child holds the hot cigarette lighter to objects, for example
  - ▶ Always hold the cigarette lighter by the knob.
  - ▶ Always make sure that the cigarette lighter is out of reach of children.
  - ▶ Never leave children unattended in the vehicle.

### Requirements:

- the ignition is switched on.

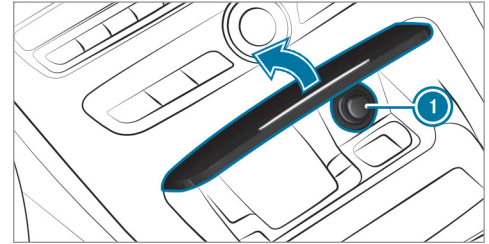

- ▶ Press in cigarette lighter ①. The cigarette lighter will pop out automatically when the heating element is red-hot.

### Sockets

#### 12 V socket in the front center console

### Requirements

- Only connect devices up to a maximum of 180 watts (15 A).

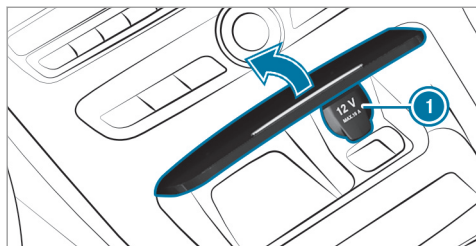

- ▶ Lift up cap ① of the socket and insert the plug of the device.

If you have connected a device to the 12 V socket, leave the cover of the stowage compartment open.

### Using the 12 V socket in the rear passenger compartment

#### Requirements:

- Only connect devices up to a maximum of 180 watts (15 A).

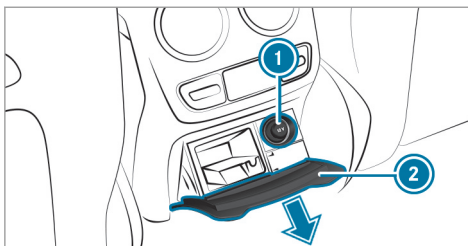

- ▶ Pull cover ② out by its top handle edge.
- ▶ Remove blind plug ① from the socket and insert the plug of the device.

### Wireless charging of the mobile phone and connection with the exterior antenna

#### Notes on wireless charging of the mobile phone

**⚠ WARNING** Risk of injury from incorrectly stowed objects

If objects in the vehicle interior are stowed incorrectly, they can slide or be thrown

around and hit vehicle occupants. In addition, cup holders, open stowage spaces and mobile phone brackets cannot always retain all objects they contain.

There is a risk of injury, particularly in the event of sudden braking or a sudden change in direction.

- ▶ Always stow objects so that they cannot be thrown around in such situations.
- ▶ Always make sure that objects do not protrude from stowage spaces, luggage nets or stowage nets.
- ▶ Close the lockable stowage spaces before starting a journey.
- ▶ Always stow and secure heavy, hard, pointed, sharp-edged, fragile or bulky objects in the trunk.

Observe the notes on loading the vehicle.

**⚠ WARNING** Risk of fire from placing objects in the mobile phone stowage compartment

If you place objects in the mobile phone stowage compartment, they may heat up excessively and even catch fire.

- ▶ Do not place additional objects, especially those made of metal, in the mobile phone stowage compartment.

**⚠ NOTE** Damage to objects caused by placing them in the mobile phone stowage compartment

If you place objects in the mobile phone stowage compartment, these may be damaged by electromagnetic fields.

- ▶ Do not place credit cards, storage media or other objects sensitive to electromagnetic fields in the mobile phone stowage compartment.

**⚠ NOTE** Damage to the mobile phone stowage compartment caused by liquids

If liquids enter the mobile phone stowage compartment, the compartment may be damaged.

- ▶ Ensure that no liquids enter the mobile phone stowage compartment.

- Depending on the vehicle equipment, the mobile phone is connected to the vehicle's exterior antenna via the charging module.
- The charging function and wireless connection of the mobile phone to the vehicle's exterior antenna are only available if the ignition is switched on.
- Small mobile phones may not be able to be charged in every position of the mobile phone stowage compartment.
- Large mobile phones which do not rest flat in the mobile phone stowage compartment may not be able to be charged or connected with the vehicle's exterior antenna.

- The mobile phone may heat up during the charging process. The mobile phone can be cooled in the mobile phone stowage compartment when the air conditioning system is switched on. The cooling output in the mobile phone stowage compartment is highest when the controller in the glove box is closed.
- To ensure more efficient charging and connection with the vehicle's exterior antenna, remove the protective cover from the mobile phone.
- When charging, the mat should be used if possible.

### Wireless charging of the mobile phone in the front

#### Requirements

- The mobile phone is suitable for wireless charging (Qi-compatible mobile phone).
- i** A list of Qi-compatible mobile phones can be found at: <http://www.mercedes-benz.com/connect>.

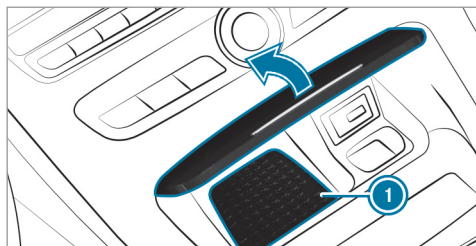

- ▶ Place the mobile phone as close to the center of mat ① as possible with the display facing upwards.

When the charging symbol is shown in the multimedia system, the mobile phone is being charged.

Malfunctions during the charging process are shown in the multimedia system display.

- ① The mat can be removed for cleaning, e.g. using clean, lukewarm water.

### Installing or removing the floor mats

**⚠ WARNING** Risk of accident due to objects in the driver's footwell

Objects in the driver's footwell may impede pedal travel or block a depressed pedal.

This jeopardizes the operating and road safety of the vehicle.

- ▶ Stow all objects in the vehicle securely so that they cannot get into the driver's footwell.
- ▶ Always install the floor mats securely and as prescribed in order to ensure that there is always sufficient room for the pedals.
- ▶ Do not use loose floor mats and do not place floor mats on top of one another.

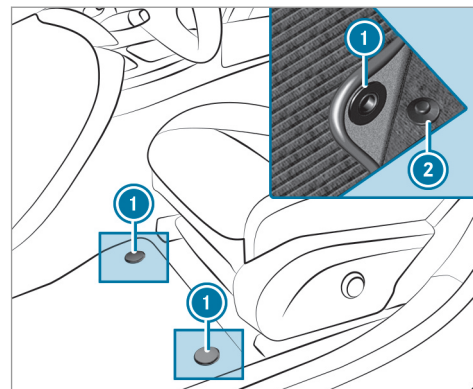

- ▶ **To install:** press stud ① into holder ②.

- ▶ **To remove:** pull the floor mat off the holders ②.



## Exterior lighting

### Lighting systems and your responsibility

The various lighting systems of the vehicle are only aids. The driver of the vehicle is responsible for correct vehicle illumination in accordance with the prevailing light and visibility conditions, legal requirements and traffic situation.

## Light switch

### Operating the light switch

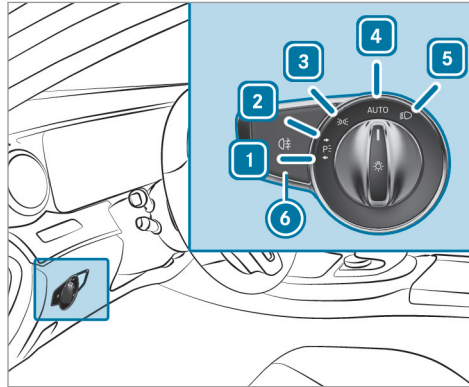

- 1 Left-hand parking lights
- 2 Right-hand parking lights
- 3 Parking lights and license plate lighting
- 4 **AUTO** Automatic driving lights (preferred light switch position)

- 5 Low beam/high beam
- 6 Switches the rear fog light on or off

When low beam is activated, the indicator lamp for the parking lights is deactivated and replaced by the indicator lamp for the low beam.

▶ Always park your vehicle safely and in a well-lit area, in accordance with the relevant legal stipulations.

**!** **NOTE** Battery discharging by operating the standing lights

Operating the standing lights over a period of hours puts a strain on the battery.

▶ Where possible, switch on the right or left parking light.

In the case of severe battery discharging, the parking lights or standing lights are automatically switched off to facilitate the next engine start.

## 112 Light and visibility

The exterior lighting (except parking and standing lights) switches off automatically when the driver's door is opened.

- Observe the notes on surround lighting (→ page 115).

### Automatic driving lights function

The parking lights, low beam and daytime running lights are switched on automatically depending on the ignition status, whether the engine is running and the light conditions.

**⚠ WARNING** Risk of accident when the low beam is switched off in poor visibility



When the light switch is set to **AUTO**, the low beam may not be switched on automatically if there is fog, snow or other causes of poor visibility such as spray.

- ▶ In such cases, turn the light switch to .

The automatic driving lights are only an aid. You are responsible for vehicle lighting.

### Activating/deactivating the rear fog light

#### Requirements

- The light switch is in the  or **AUTO** position.
- ▶ Press the  button.

Please observe the country-specific laws on the use of rear fog lights.

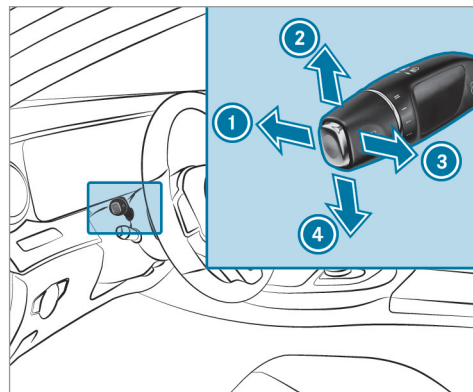

### Operating the lights combination switch



- 1 High-beam headlamps
- 2 Turn signal light, right
- 3 High-beam flasher
- 4 Turn signal light, left

- ▶ Use the combination switch to activate the function in question.

### High-beam headlamps

- ▶ **To switch on:** turn the light switch to the  or **AUTO** position.
- ▶ Press the combination switch beyond the pressure point in the direction of arrow ①. When the high beam is activated, the  indicator lamp for low beam is deactivated and replaced by the  indicator lamp for the high beam.
- ▶ **To switch off:** move the combination switch back to its starting position.

### Headlamp flasher:

- ▶ Pull the combination switch in the direction of arrow ③.

### Turn signals

- ▶ **To indicate briefly:** press the combination switch briefly up to the pressure point in the direction of arrow ② or ④. The corresponding turn signal light flashes three times.
- ▶ **To indicate permanently:** press the combination switch beyond the pressure point in the direction of arrow ② or ④.

### Activating/deactivating the hazard warning light

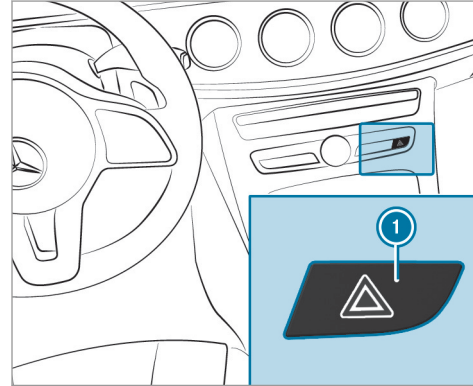

- ▶ Press button ①.

### Cornering light

#### Cornering light function

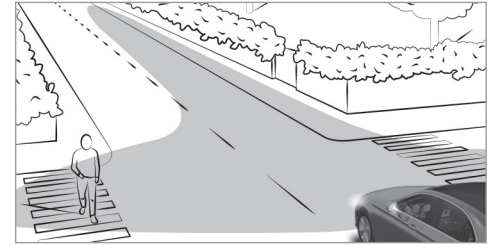

The cornering light improves the illumination of the carriageway over a wide angle in the turning direction, enabling better visibility on tight bends, for example. It can be activated only when the low beam is switched on.

The function is active:

- At speeds below 25 mph (40 km/h) when the turn signal light is switched on or the steering wheel is turned.

- At speeds between 25 mph (40 km/h) and 45 mph (70 km/h) when the steering wheel is turned.

**Traffic circle and intersection function:** the cornering light is activated on both sides through an evaluation of the current GPS position of the vehicle. It remains active until after the vehicle has left the traffic circle or the intersection.

### Adaptive Highbeam Assist

#### Function of Adaptive Highbeam Assist

**⚠ WARNING** Risk of accident despite Adaptive Highbeam Assist

Adaptive Highbeam Assist does not recognize the following road users:

- Road users without lights, e.g. pedestrians
- Road users with poor lighting, e.g. cyclists
- Road users whose lighting is obstructed, e.g. by a barrier

On very rare occasions, Adaptive Highbeam Assist may fail to recognize other road users with their own lighting, or may recognize them too late.

In these or similar situations, the automatic high beam is not deactivated or is activated despite the presence of other road users.

- ▶ Always observe the traffic carefully and switch off the high beam in good time.

#### System limitations

Adaptive Highbeam Assist cannot take into account road, weather or traffic conditions.

Detection may be restricted if:

- Visibility is impaired, for example in fog, heavy rain or snow.
- There is dirt on the sensors or the sensors are obscured.

Adaptive Highbeam Assist is only an aid. You are responsible for adjusting the vehicle's lighting to the prevailing light, visibility and traffic conditions.

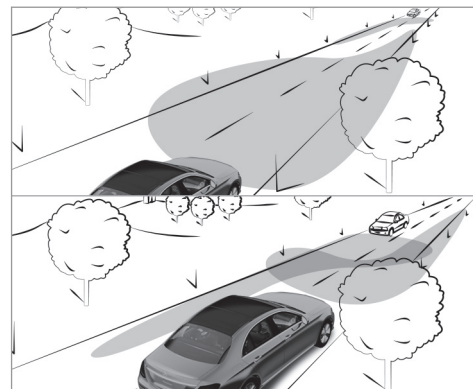

Adaptive Highbeam Assist switches automatically between:

- Low beam
- High beam

At speeds above 19 mph (30 km/h):

- If no other road users are detected, high beam is automatically switched on.

High beam switches off automatically:

- At speeds below 16 mph (25 km/h).
- If other road users are detected.
- If street lighting is sufficient.

At speeds above approx. 31 mph (50 km/h):

- The headlamp range of low beam is regulated automatically based on the distance to other road users.

The system's optical sensor is located behind the windshield near the overhead control panel.

### Switching Adaptive Highbeam Assist on/off

- ▶ **To switch on:** turn the light switch to the **AUTO** position.
- ▶ Switch on the high beam using the combination switch.  
When the high beam is switched on automatically in the dark, the  indicator lamp in the multifunction display comes on.
- ▶ **To switch off:** switch off the high beam using the combination switch.

### Switching the daytime running lights on/off

Multimedia system:

↳ Vehicle ▶  Light Settings ▶ Day-time Run. Lights

- ▶ Activate  or deactivate  the function.

### Setting the exterior lighting switch-off delay time

Multimedia system:

↳ Vehicle ▶  Light Settings ▶ Ext. Light Del. Sw. off

- ▶ Set the switch-off delay time.

### Setting the surround lighting

Multimedia system:

↳ Vehicle ▶  Light Settings ▶ Locator Lighting

- ▶ Switch the function on  or off .







If the surround lighting is switched on, the exterior lighting remains lit for 40 seconds after the

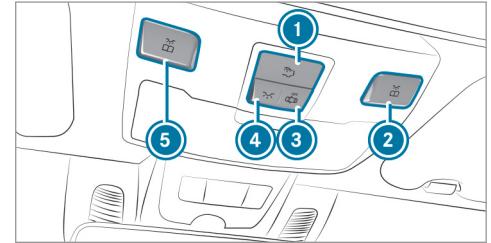

vehicle is unlocked. When you start the vehicle, the surround lighting is switched off and automatic driving lights are activated.

## Interior lighting

### Adjusting the interior lighting



- ▶   Switches the rear interior lighting on/off
- ▶   Switches the front right-hand reading lamp on/off
- ▶   Switches the automatic interior lighting control on/off

- ▶ ④  Switches the front interior lighting on/off
- ▶ ⑤  Switches the front left-hand reading lamp on/off

### Adjusting the ambient lighting

---

Multimedia system:

↳ Vehicle ▶  Light Settings ▶ Ambient Light

#### Setting the color

- ▶ Select **Color**.
- ▶ Set a color.

#### Adjusting the brightness

- ▶ Select **Brightness**.
- ▶ Set a brightness value.

#### Activating the brightness for zones

- ▶ Select **Brightness Zones**.
- ▶ Activate  or deactivate  the function. The **Display**, **Front** and **Rear** zones can be set separately.

- ▶  Setting brightness zones is not available for the Rear Seat Entertainment System.

#### Activating multi-colored lighting

- ▶ Select **Multi-color**.
- ▶ Activate  or deactivate  the function. There are ten preset color combinations available.

#### Activating multi-colored animation

- ▶ Select **Multi-color Animation**.
- ▶ Activate  or deactivate  the function. The chosen color combination changes in a predefined rhythm.

#### Activating climate-dependent lighting

- ▶ Select **Climate**.
- ▶ Activate  or deactivate  the function. The color of the ambient lighting adapts to suit the air conditioning setting.

#### Activating welcome lighting

- ▶ Select **Welcome**.

- ▶ Activate  or deactivate  the function. When the vehicle is unlocked, a special interior lighting sequence runs.

### Setting the interior lighting switch-off delay time

---

Multimedia system:

↳ Vehicle ▶  Light Settings ▶ Int. Light Switch Off

- ▶ Set the switch-off delay time.

## Windshield wiper and windshield washer system

### Switching the windshield wipers on/off

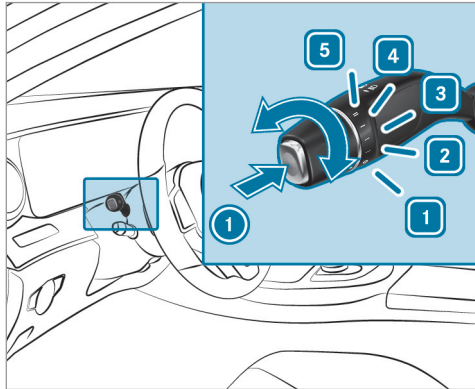

- 1 0 Windshield wipers off
- 2 ... Intermittent wiping, normal
- 3 .... Intermittent wiping, frequent

- 4 — Continuous wiping, slow
- 5 == Continuous wiping, fast

- ▶ Turn the combination switch to the correct position 1 - 5.
- ▶ **Single wipe/washing:** push the button on the combination switch in the direction of arrow 1.
  - Single wipe
  - Wipes with washer fluid

### Changing the windshield wiper blades

**⚠ WARNING** Risk of becoming trapped if the windshield wipers are switched on while wiper blades are being replaced

If the windshield wipers begin to move while you are changing the wiper blades, you can be trapped by the wiper arm.

- ▶ Always switch off the windshield wipers and the ignition before changing the wiper blades.

### Moving the wiper arms to a vertical position

- ▶ Set the windshield wipers to the slow continuous wiping position on the combination switch.
- ▶ As soon as the wiper arms are vertical relative to the hood, switch off the ignition.

### Removing the wiper blades

- ▶ Fold the wiper arms away from the windshield.

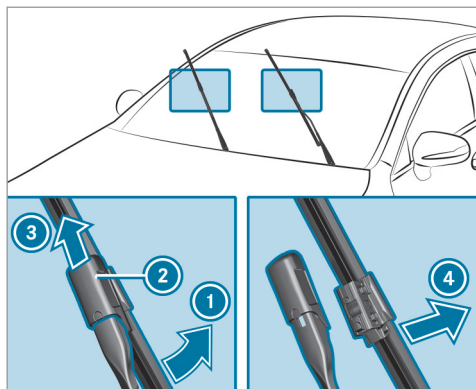

- ▶ Hold the wiper arm with one hand. With the other hand, turn the wiper blade in the direction of arrow ① away from the wiper arm to the stop.
- ▶ Slide catch ② in the direction of arrow ③ until it engages in the removal position.
- ▶ Remove the wiper blade in the direction of arrow ④ away from the wiper arm.

### Fitting the wiper blades

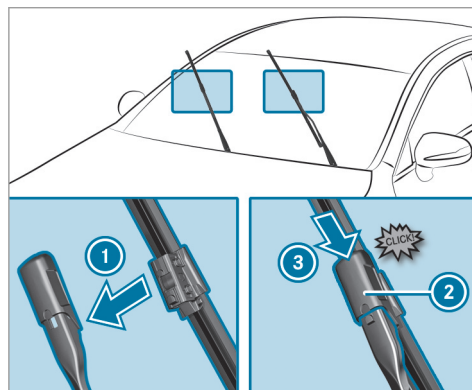

- ▶ Insert the new wiper blade into the wiper arm in the direction of arrow ①.
- ▶ Slide catch ② in the direction of arrow ③ until it engages in the locking position.
- ▶ Make sure that the wiper blade sits correctly.
- ▶ Fold the wiper arms back onto the windshield.

### Maintenance display

The maintenance display is only available for standard windshield wipers.

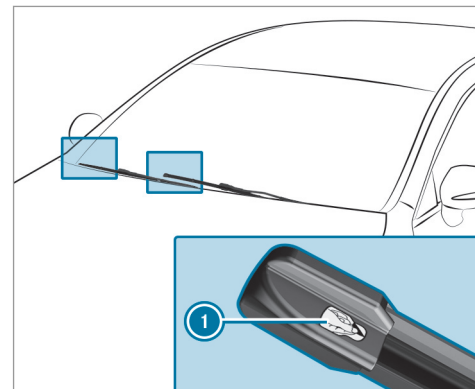

- ▶ Remove protective film ① of the maintenance display on the tip of the newly installed wiper blades.



If the color of the maintenance display changes from black to yellow, the wiper blades should be replaced.

- ⓘ The duration of the color change varies depending on the usage conditions.

### Replacing the windshield wiper blades (MAGIC VISION CONTROL)

**⚠ WARNING** Risk of becoming trapped if the windshield wipers are switched on while wiper blades are being replaced

If the windshield wipers begin to move while you are changing the wiper blades, you can be trapped by the wiper arm.

- ▶ Always switch off the windshield wipers and the ignition before changing the wiper blades.

#### Moving the wiper arms to a vertical position

- ▶ Switch on the power supply.

- ▶ Set the windshield wiper to the  slow continuous wiping position on the combination switch.
- ▶ As soon as the wiper arms are vertical relative to the hood, switch off the power supply.

#### Removing the wiper blades

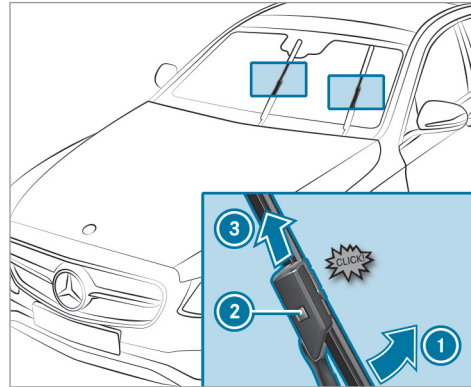

- ▶ **To bring the wiper blade into position to be removed:** raise the wiper arm from

the windshield and hold it with one hand. With the other hand, turn the wiper blade in the direction of arrow ① beyond the point of resistance.

The wiper blade engages in the removal position with a click.

- ▶ **To remove the wiper blade:** press release knob ②, pull the wiper blade in the direction of arrow ③ and remove.

### Installing the wiper blades

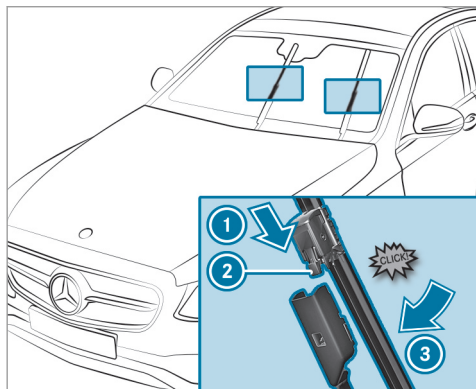

- ▶ Push the new wiper blade onto the wiper arm in the direction of arrow ① until release knob ② engages.

- ▶ Press the wiper blade beyond the point of resistance in the direction of arrow ③ on the wiper arm.  
The wiper blade engages with a noticeable click and moves freely again.
- ▶ Lay the wiper arm back on the windshield.

### Mirrors

#### Operating the outside mirrors

- ⚠ **WARNING** Risk of injury from adjusting the vehicle settings while the vehicle is in motion

You could lose control of the vehicle in the following situations:

- if you adjust the driver's seat, the head restraint, the steering wheel or the mirror while the vehicle is in motion
- if you fasten your seat belt while the vehicle is in motion
- ▶ Before starting the engine: adjust the driver's seat, the head restraint, the

steering wheel or the mirror and fasten your seat belt.

- ⚠ **WARNING** Risk of accident due to misjudgment of distances when using the passenger mirror

The outside mirror on the front passenger side reflects objects on a smaller scale. The objects in view are in fact closer than they appear.

As a result, you may misjudge the distance between you and the road user driving behind you, for example, when changing lanes.

- ▶ Therefore, always look over your shoulder in order to ensure that you are aware of the actual distance between you and the road users driving behind you.

### Folding the outside mirrors in/out

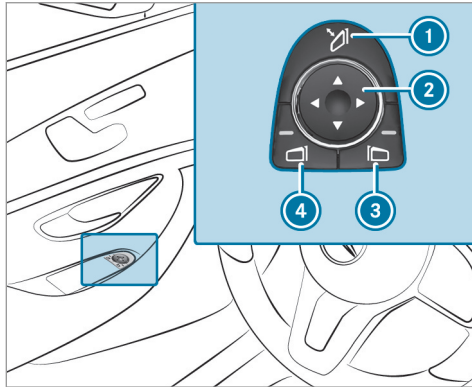

▶ Briefly press switch ①.

ⓘ If the battery has been disconnected or completely discharged, the outside mirrors must be reset. Only then will the automatic mirror folding function work properly.

### Adjusting the outside mirrors

- ▶ Press the ③ or ④ buttons to select the outside mirror to be set.
- ▶ Press the ② button to set the position of the mirror glass.

### Engaging the outside mirrors

- ▶ Press and hold button ①. You will hear a click and the mirror audibly engage in position. The outside mirror is set in the correct position.

### Automatic anti-glare mirrors function

**⚠ WARNING** Risk of burns and poisoning due to the anti-glare mirror electrolyte

Electrolyte may escape if the glass in an automatic anti-glare mirror breaks.

The electrolyte is harmful and causes irritation. It must not come into contact with your skin, eyes, respiratory organs or clothing or be swallowed.

- ▶ If you come into contact with electrolyte, observe the following:
  - Rinse the electrolyte from your skin and seek medical attention immediately.
  - If electrolyte comes into contact with your eyes, rinse them thoroughly with clean water and seek medical attention immediately.
  - If the electrolyte is swallowed, immediately rinse your mouth out thoroughly. Do not induce vomiting. Seek medical attention immediately.
  - Immediately change out of clothing which has come into contact with electrolyte.
  - If an allergic reaction occurs, seek medical attention immediately.

The inside rearview mirror and the outside mirror on the driver's side automatically go into anti-glare mode if light from a headlamp hits the inside rearview mirror.

### System limitations

The system does not go into anti-glare mode in the following situations:

- the engine is switched off.
- reverse gear is engaged
- the interior lighting is switched on

### Function of the front-passenger outside mirror parking position

- ① The parking position is available only in vehicles with a memory function.

The parking position makes parking easier.

The front-passenger outside mirror tilts downwards and shows the rear wheel on the front passenger side in the following situations:

- the parking position is stored (→ page 122)
- the passenger mirror is selected
- reverse gear is engaged

The front-passenger outside mirror moves back to its original position in the following situations:

- if you shift the transmission to another transmission position
- at speeds greater than 9 mph (15 km/h)
- if you press the button for the outside mirror on the driver's side

### Storing the parking position of the passenger outside mirror using reverse gear

#### Storing

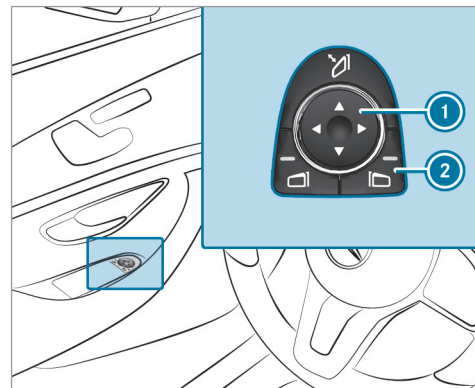

- ▶ Select the passenger outside mirror using button ②.
- ▶ Engage reverse gear.
- ▶ Move the passenger outside mirror into the desired parking position using button ①.

**Calling up**

- ▶ Select the passenger outside mirror using button ②.
- ▶ Engage reverse gear.  
The passenger outside mirror moves to the stored parking position.

**Activating/deactivating the automatic mirror folding function**

Multimedia system:

↳ Vehicle ▶  Vehicle Settings ▶ Autom. Mirror Folding

- ▶ Activate  or deactivate  the function.

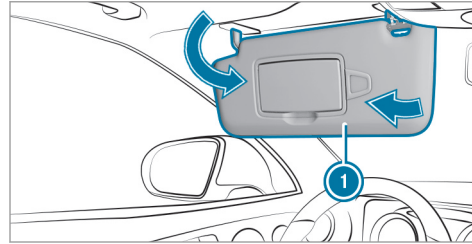
**Operating the sun visors****Using the single sun visor**

- ▶ **Glare from the front:** fold sun visor ① down.
- ▶ **Glare from the side:** swing sun visor ① to the side.

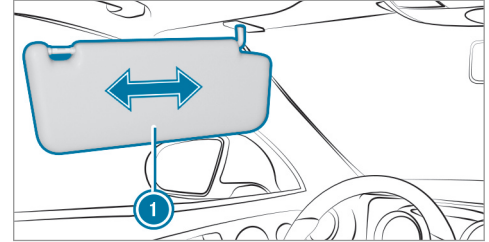

- ▶ Vehicles with an extendable sun visor: slide sun visor ① horizontally as required.

## Overview of climate control systems

### Control panel overview for dual-zone automatic climate control

The indicator lamps in the buttons indicate that the current function is activated.

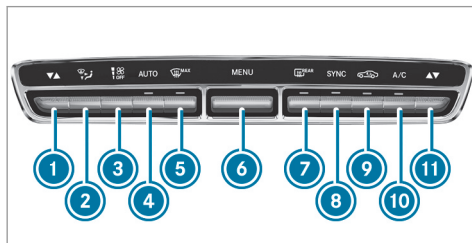

- ① Sets the driver's side temperature
- ② Sets the air distribution
- ③ Sets the airflow or switches off climate control
- ④ **AUTO** Sets climate control to automatic mode (→ page 125)
- ⑤ Defrosts the windshield



- ⑥ **MENU** Calls up the air conditioning menu
- ⑦ Switches the rear window heater on/off
- ⑧ **SYNC** Activates or deactivates synchronization (→ page 126)
- ⑨ Activates/deactivates air-recirculation mode (→ page 127)
- ⑩ **A/C** Switches the A/C function on/off (→ page 125)
- ⑪ Sets the front passenger side temperature

### 3-zone automatic climate control panel overview

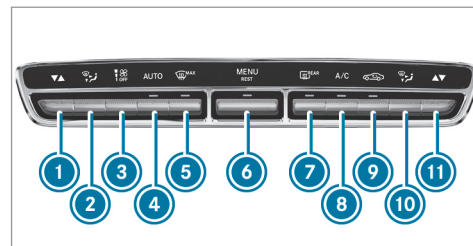
The indicator lamps in the buttons indicate that the current function is activated.



- ① Sets the driver's side temperature
- ② Sets the driver's side air distribution
- ③ Sets the airflow or switches off climate control
- ④ **AUTO** Sets climate control to automatic mode (→ page 125)
- ⑤ Defrosts the windshield
- ⑥ **MENU** Calls up the air conditioning menu  
Switches the residual heat on/off (→ page 127)
- ⑦ Switches the rear window heater on/off
- ⑧ **A/C** Switches the A/C function on/off (→ page 125)

- ⑨  Switches air-recirculation mode on/off (→ page 127)
- ⑩  Sets the front passenger side air distribution
- ⑪  Sets the front passenger side temperature

### Rear operating unit

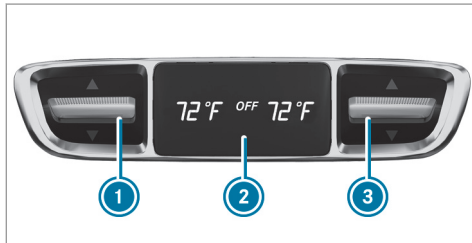

You can set the temperature for the entire rear compartment using buttons ① or ③.



- ① Sets the temperature
- ② Display
- ③ Sets the temperature

## Operating the climate control system

### Activating/deactivating climate control

- ▶ **To activate:** set the airflow to level 1 or higher using the  button.
- ▶ **To deactivate:** set the airflow to level 0 using the  button.

ⓘ If climate control is deactivated, the windows can fog up more quickly. Deactivate climate control only briefly.

### Activating/deactivating the A/C function via the control panel

The A/C function cools, heats and dehumidifies the interior air in the vehicle.

- ▶ Press the  button.

Deactivate the A/C function only briefly otherwise the windows can fog up more quickly.

Condensation may drip from the underside of the vehicle when cooling mode is active. This is not a sign that there is a malfunction.

### Activating/deactivating the A/C function using the multimedia system

Multimedia system:



➔ Vehicle ➔  Climate Control ➔ A/C

The A/C function heats, cools and dehumidifies the vehicle's interior air.

- ▶ Switch the function on  or off .

### Setting climate control to automatic

In automatic mode, the set temperature is controlled and maintained at a constant level by the air supply.

- ▶ Press the  button.
- ▶ **To switch to manual mode:** press the  or  button.

## Climate style

### Climate style function

In automatic mode, you can select the following climate style settings for the driver's and front passenger areas:

- **FOCUS:** high airflow, slightly cooler setting
- **MEDIUM:** medium airflow, standard setting
- **DIFFUSE:** low airflow, slightly warmer and draft-free setting

### Adjusting the climate style settings

Multimedia system:









→ Vehicle ►  Climate Control ► Climate Mode

► Select **FOCUS**, **MEDIUM** or **DIFFUSE**.

ⓘ In order to feel the effect of the climate style, the **AUTO** function must be active (→ page 125).

## Overview of air distribution settings

The symbols in the display indicate which vents the airflow is being directed through:

-  demister vents
-  center and side air vents
-  footwell vents
-  center, side and footwell vents
-  defroster and footwell vents
-  all vents
-  defroster, middle and side air vents
-  automatic air distribution

## Activating/deactivating the climate control synchronization function via the control panel

Climate control can be set centrally using the synchronization function. The temperature and air distribution setting for the driver's side is adopted automatically for the front passenger side.

► Press the **SYNC** button.

The synchronization function is deactivated if the settings for one of the other climate zones are changed.

## Activating/deactivating the climate control synchronization function using the multimedia system

Multimedia system:

→ Vehicle ►  Climate Control ► SYNC

Climate control can be set centrally using the synchronization function. The temperature setting is automatically adopted for all climate zones.

► Switch the function on  or off .

## Defrosting the windows

### Windows fogged up on the inside

► Press the **AUTO** button.

► If the windows continue to fog up: press the  button.



### Windows fogged up on the outside

- ▶ Switch on the windshield wiper.
- ▶ Press the **AUTO** button.

### Switching air-recirculation mode on/off

- ▶ Press the  button.
- ▶ The interior air will be recirculated.

Air-recirculation mode is switched off automatically.

- ▶  If air-recirculation mode is switched on, the windows may fog up more quickly. Switch on air-recirculation mode only briefly.

### Switching the residual heat on or off

#### Requirements:

- The vehicle is parked.

It is possible to make use of the residual heat from the engine to continue heating or ventilating the front compartment of the vehicle for approximately 30 minutes.

- ▶ **To switch on:** press the  button.

Residual heat is switched off automatically.

### Activating and deactivating ionization

Multimedia system:

- ▶  Vehicle ▶  Climate Control ▶ Ionization

Ionization cleans and refreshes the interior air of the vehicle. The ionization of the interior air is odorless.

- ▶ Switch the function on  or off .

### Fragrance system

#### Setting the fragrance system

#### Requirements

- Automatic climate control is activated.
- The glove box is closed.

Multimedia system:

- ▶  Vehicle ▶  Climate Control ▶ Air Freshener

The fragrance system distributes a pleasant fragrance throughout the vehicle interior from a flacon located in the glove box.

- ▶ **To set the intensity:** select **High**, **Medium**, **Low** or **Off**.

#### Inserting or removing the flacon of the fragrance system

 **WARNING** Risk of injury from liquid perfume

If children open the flacon, they could drink the liquid perfume or it could come into contact with their eyes.

- ▶ Consult a doctor immediately if liquid perfume has been drunk.
- ▶ If liquid perfume comes into contact with your eyes or skin, rinse your eyes with clean water.
- ▶ If symptoms continue, consult a doctor.

 **ENVIRONMENTAL NOTE** Environmental damage due to improper disposal of full flacons



Full flacons must not be disposed of with household waste.



Full flacons must be taken to a harmful substance collection point.

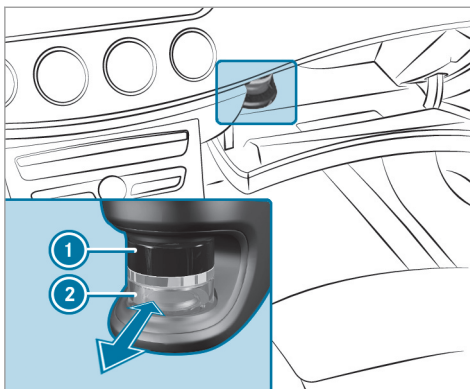

- ① Cap
- ② Flacon

- ▶ **To insert:** slide the flacon into the holder as far as it will go.
- ▶ **To remove:** pull out the flacon.

If you do not use genuine Mercedes-Benz interior perfumes, observe the manufacturers' safety notices on the perfume packaging.

Dispose of the genuine Mercedes-Benz interior perfume flacon when it is empty and do not refill it.

#### Refillable flacon

- ▶ Unscrew the cap of the empty flacon.
- ▶ Fill the flacon with a maximum of 0.5 fl. oz. (15 ml).
- ▶ Screw the cap back on to the flacon.

Always refill the empty refillable flacon with the same perfume. Observe the separate information sheet attached to the flacon.

#### Air vents

##### Adjusting the front air vents

 **WARNING** - Danger of burns or frostbite due to being too close to the air vents

Very hot or very cold air can flow from the air vents.

This could result in burns or frostbite in the immediate vicinity of the air vents.

- ▶ Make sure that all vehicle occupants always maintain a sufficient distance to the air vents.
- ▶ If necessary, direct the airflow to another area of the vehicle interior.

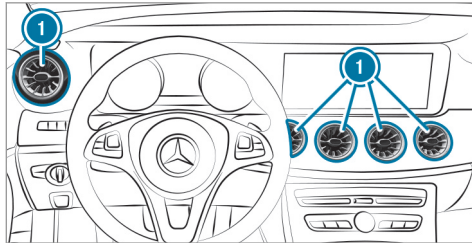

- ▶ **To open or close:** turn the center of air vent ① counter-clockwise or clockwise as far as it will go.
- ▶ **To adjust the air direction:** hold air vent ① in the center and move it up or down or to the left or right.

### Adjusting the rear air vents

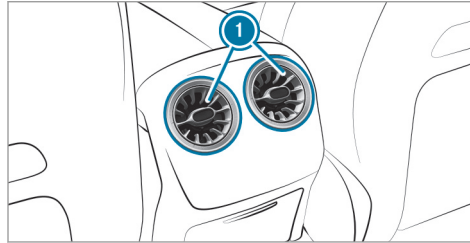

- ▶ **To open or close:** turn the center of the rear air vent ① to the left or right as far as it will go.
- ▶ **To adjust the air direction:** hold rear air vent ① in the center and move it up or down or to the left or right.

### Opening/closing the air vent in the glove box

**!** **NOTE** Damage to temperature-sensitive objects in the glove box

Temperature-sensitive objects stored in the glove box may be damaged by the air vent located inside it.

- ▶ Close the air vent when you heat the vehicle.
- ▶ At high outside temperatures, open the air vent and switch on the A/C function.

#### Requirements:

- Automatic climate control is activated.

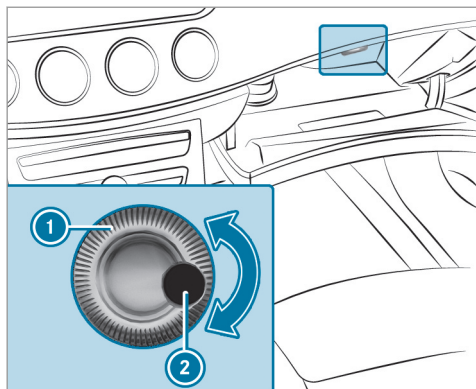

- ① Air vent controller
- ② Air vent

▶ **To open or close:** turn controller ① to the left or right.

### Adjusting the AIRSCARF vents

**⚠ WARNING** Risk of burns caused by the heating output from AIRSCARF being too high

When AIRSCARF is switched on, very hot air can flow from the outlet opening in the head restraints.

This could result in burns in the immediate vicinity of the outlet opening.

▶ Turn the heating output down in good time.

**! NOTE** Damage caused to AIRSCARF by the use of protective covers

If a protective cover is placed over the front seat head restraints, the flow of air from the AIRSCARF vent is hindered.

This can cause AIRSCARF to overheat and be damaged.

▶ Do not use protective covers on head restraints with AIRSCARF.

Make sure that there are no objects covering the intake grille on the back of the head restraint.

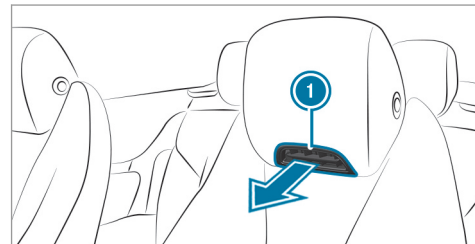

- ▶ You can adjust the blower output of AIRSCARF vents ① using the AIRSCARF button (→ page 94).
- ▶ Adjust the height of AIRSCARF vents ① and the current of air by adjusting the height of the head restraint (→ page 89).

## Driving

### Switching on the power supply or ignition using the Start/Stop button

**⚠ WARNING** Risk of accident and injury due to children left unattended in the vehicle

If children are left unattended in the vehicle, they could:

- Open doors, thereby endangering other persons or road users
- Get out of the vehicle and be hit by oncoming traffic
- Operate vehicle equipment

In addition, the children could also set the vehicle in motion, for example, by:

- Releasing the parking brake
- Shifting the transmission out of park position **P**
- Starting the engine.

- ▶ Never leave children and animals unattended in the vehicle.
- ▶ When leaving the vehicle, always take the SmartKey with you and lock the vehicle.
- ▶ Keep the SmartKey out of the reach of children.

**⚠ WARNING** Risk of exhaust gas poisoning

Combustion engines emit poisonous exhaust gases such as carbon monoxide. Inhaling these exhaust gases causes poisoning.

- ▶ Never leave the engine running in an enclosed space without sufficient ventilation.

**⚠ WARNING** Risk of fire caused by flammable material on the exhaust system

Flammable materials brought in by either animals or environmental influences may ignite if they come into contact with hot parts of the engine or exhaust system.

- ▶ Therefore, check regularly that there are no flammable materials in the engine compartment or on the exhaust system.

#### Requirements:

- The SmartKey is located in the vehicle and the SmartKey battery is not discharged.

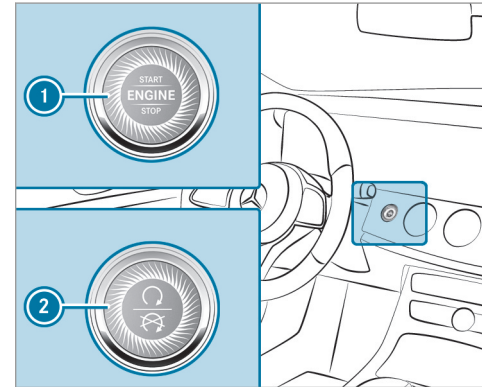

- ▶ **To switch on the power supply:** press button ① (USA) or ② (Canada) once. You can activate the windshield wiper, for example.

The power supply is switched off again if the following conditions are met:

- you open the driver's door.
- you press button ① (USA) or ② (Canada) twice.

- ▶ **To switch on the ignition:** press button ① (USA) or ② (Canada) twice. The indicator lamps in the instrument cluster light up.

The ignition is switched off again if one of the following conditions is met:

- You do not start the vehicle within 15 minutes.

The transmission is in position **P**.

or

The electric parking brake is applied.

- You press button ① (USA) or ② (Canada) once.

## Starting the vehicle

### Starting the vehicle with the start/stop button

#### Requirements:

- The SmartKey is located in the vehicle and the SmartKey battery is not discharged.
- ▶ Shift the transmission to position **P** or **N**.
- ▶ Depress the brake pedal and push button ① (USA) or ② (Canada) once.
- ▶ If the vehicle does not start: switch off non-essential consumers and press button ① (USA) or ② (Canada) once.
- ▶ If the vehicle still does not start and the **Place the Key in the Marked Space See Operator's Manual** display message also appears in the multifunction display: start the vehicle in emergency operation mode.

You can switch off the engine while driving by pressing button ① (USA) or ② (Canada) for about three seconds. Be sure to observe the safety notes under "Driving instructions".

### Starting the vehicle in emergency operation mode

If the vehicle does not start and the **Place the Key in the Marked Space See Operator's Manual** display message appears in the multifunction display, you can start the vehicle in emergency operation mode.

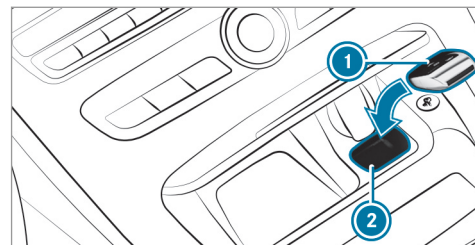

- ▶ Ensure that marked space ② is empty.
  - ▶ Remove SmartKey ① from the key ring.
  - ▶ Lay SmartKey ① in marked space ②. The vehicle will start after a short while.
- If you remove SmartKey ① from marked space ②, the engine starts again. For further vehicle starts, however, SmartKey ①

must be located in marked space ② during the entire journey.

- ▶ Have SmartKey ① checked at a qualified specialist workshop.

#### If the vehicle does not start:

- ▶ Leave SmartKey ① in marked space ②.
  - ▶ Depress the brake pedal and start the vehicle using the start/stop button.
  - ▶ Start the vehicle using the start/stop button.
- ① You can also switch on the power supply or the ignition with the start/stop button.

#### Starting the vehicle via Remote Online services

##### Cooling or heating the vehicle interior before starting a journey

① This function is not available in all countries. If you start the vehicle via your smartphone, the previously selected air conditioning setting is active.

Ensure the following before starting the engine:

- The legal stipulations in the area where your vehicle is parked allow engine starting via smartphone.
- It is safe to start and run the engine where your vehicle is parked.
- The fuel tank is sufficiently filled.
- The starter battery is sufficiently charged.

#### Starting the vehicle

**⚠ WARNING** Risk of crushing or entrapment due to unintentional starting of the engine

Limbs could be crushed or trapped if the engine is started unintentionally during service or maintenance work.

- ▶ Always secure the engine against unintentional starting before carrying out maintenance or repair work.

#### Requirements:

- park position **P** is selected.
- the anti-theft alarm system is not activated.

- the panic alarm is not activated.
  - the hazard warning lights are switched off.
  - the hood is closed.
  - the doors are closed and locked.
  - the windows and soft top are closed.
- ▶ Start the vehicle using the smartphone:
- after every vehicle start, the engine runs for ten minutes.
  - you can carry out a maximum of two consecutive starting attempts.
  - you can stop the vehicle again at any time.
  - further information can be found in the smartphone app.

#### Securing the engine against starting before carrying out maintenance or repair work:

- ▶ Switch on the hazard warning lights.
- or
- ▶ Unlock the doors.
- or
- ▶ Open a side window or the soft top.

### Running-in notes

To preserve the engine during the first 1,000 miles (1,500 km):

- drive at varying road speeds and engine speeds.
- drive in drive program **C** or **E**.
- change gear before the rev counter needle is  $\frac{2}{3}$  of the way to the red area of the rev counter.
- do not shift down a gear manually in order to brake.
- avoid overstraining the vehicle, e.g. driving at full throttle.
- do not depress the accelerator pedal past the pressure point (kickdown).
- only increase the engine speed gradually and accelerate the vehicle to full speed after 1,000 miles (1,500 km).

This also applies when the engine or parts of the drivetrain have been replaced.

Please also observe the following running-in notes:

- In certain driving and driving safety systems, the sensors adjust automatically while a certain distance is driven after the vehicle has been delivered or after repairs. Full system effectiveness is not achieved until the end of this teach-in process.
- Brake pads, brake discs and tires that are either new or have been replaced only achieve optimum braking effect and grip after several hundred kilometers of driving. Compensate for the reduced braking effect by applying greater force to the brake pedal.

### Notes on driving

**⚠ WARNING** Risk of accident due to objects in the driver's footwell

Objects in the driver's footwell may impede pedal travel or block a depressed pedal.

This jeopardizes the operating and road safety of the vehicle.

- ▶ Stow all objects in the vehicle securely so that they cannot get into the driver's footwell.
- ▶ Always install the floor mats securely and as prescribed in order to ensure that there is always sufficient room for the pedals.
- ▶ Do not use loose floor mats and do not place floor mats on top of one another.

**⚠ WARNING** Risk of accident due to unsuitable footwear

Operation of the pedals may be restricted due to unsuitable footwear such as:

- Shoes with platform soles
- Shoes with high heels
- Slippers
- ▶ When driving always wear suitable shoes in order to be able to operate the pedals safely.



- ▲ **WARNING** Risk of accident due to the ignition being switched off whilst the vehicle is in motion

If you switch off the ignition whilst the vehicle is in motion safety-relevant functions will be restricted or no longer available. This may affect the power steering system and brake force boosting, for example.

You will need to use considerably more force to steer and brake.

- ▶ Do not switch off the ignition whilst the vehicle is in motion.

- ▲ **WARNING** Risk of exhaust gas poisoning

Combustion engines emit poisonous exhaust gases such as carbon monoxide. Inhaling these exhaust gases causes poisoning.

- ▶ Never leave the engine running in an enclosed space without sufficient ventilation.

- ▲ **WARNING** Risk of skidding and of an accident due to shifting down on slippery road surfaces

If you shift down on slippery road surfaces to increase the engine braking effect, the drive wheels may lose traction.

- ▶ Do not shift down on slippery road surfaces to increase the engine braking effect.

- ▲ **DANGER** Risk of fatal injury due to poisonous exhaust gases

If the tailpipe is blocked or sufficient ventilation is not possible, poisonous exhaust gases such as carbon monoxide may enter the vehicle. This is the case if the vehicle gets stuck in snow, for example.

- ▶ Keep the tailpipe and the area around the vehicle free from snow when the engine or the stationary heater are running.

- ▶ Open a window on the windward side of the vehicle to ensure an adequate supply of fresh air.

- ▲ **WARNING** Risk of accident and injury due to being under the influence of alcohol and drugs while driving

Driving when under the influence of alcohol and/or drugs is an extremely dangerous combination. Even small quantities of alcohol or drugs may affect your reflexes, perception and judgment.

The probability of a serious or even fatal accident greatly increases if you drive when under the influence of alcohol or drugs.

- ▶ Do not drink alcohol or take drugs while driving, and do not allow anyone to drive who has been drinking alcohol or taking drugs.

**⚠ WARNING** Risk of accident due to the brake system overheating

If you leave your foot on the brake pedal when driving, the brake system may overheat.

This increases the braking distance and the brake system may even fail.

- ▶ Never use the brake pedal as a footrest.
- ▶ Do not depress the brake pedal and the accelerator pedal at the same time while driving.

**! NOTE** Wearing out the brake linings by continuously depressing the brake pedal

- ▶ Do not depress the brake pedal continuously whilst driving.
- ▶ To use the braking effect of the engine, shift to a lower gear in good time.

**! NOTE** Damage to the drivetrain and the engine when pulling away

- ▶ Do not warm up the engine when the vehicle is stationary. Pull away immediately.
- ▶ Avoid high engine speeds and driving at full throttle until the engine has reached operating temperature.
- ▶ Do not allow the wheels to spin.

**! NOTE** Damage to the catalytic converter due to non-combusted fuel

The engine is not running smoothly and is misfiring.

Non-combusted fuel may get into the catalytic converter.

- ▶ Only depress the accelerator pedal slightly.
- ▶ Have the cause rectified immediately at a qualified specialist workshop.

Limited braking effect on salt-treated roads:

- due to salt build-up on the brake discs and brake lining, the braking distance can increase considerably or result in braking only on one side.
- maintain a much greater safe distance to the vehicle in front.

To prevent salt build-up:

- brake occasionally while paying attention to the traffic conditions.
- carefully depress the brake pedal at the end of the journey and when starting the next journey.

### ECO start/stop function

#### **Operating the ECO start/stop function**

The engine is automatically switched off if the following conditions are met:

- You brake the vehicle to a standstill in transmission position **D** or **N**.
- All vehicle conditions for an automatic engine stop are met.

The  symbol appears in the multifunction display when the vehicle is stationary.

The engine is restarted automatically if:

- You release the brake pedal in transmission position **D** when the HOLD function is not active.
- You shift from transmission position **P**.
- You engage transmission position **D** or **R**.
- You depress the accelerator pedal
- You change the vehicle level.
- You open or close the soft top.
- An automatic engine start is necessary.

If the engine was switched off by the ECO start/stop function and you leave the vehicle, a warning tone sounds. The **Vehicle Operational Switch the Ignition Off Before Exiting** display message also appears in the multifunction display. If you do not switch off the ignition, the ignition is automatically switched off after one minute.

### Deactivating or activating the ECO start/stop function

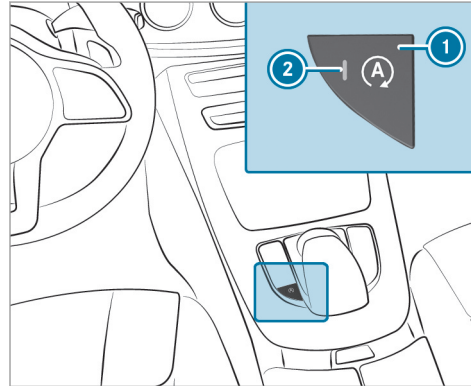

- ▶ Press button **1**.  
If indicator lamp **2** lights up, the ECO start/stop function is switched on.
- ⓘ Depending on the model, the button may also be located at a different position in the center console.

### Function of the ECO display

The ECO display summarizes the driving style from the start of the journey to its completion and assists you in achieving the most economical driving style.

You can influence consumption if you:

- drive with particular care
- drive the vehicle in drive program **E**
- observe the gearshift recommendations

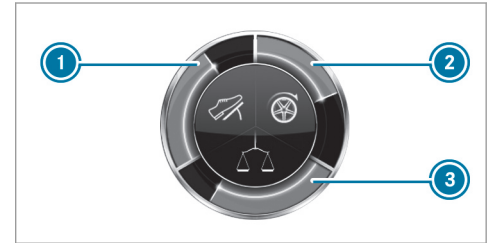

The inner segment lights up green and the outer segment fills up:

- **1** Moderate acceleration

- ② Gentle deceleration and rolling
- ③ Consistent speed

The inner segment is grey and the outer segment empties:

- ① Sporty acceleration
- ② Heavy braking
- ③ Fluctuations in speed

You have driven economically when:

- the three outer segments are completely filled simultaneously.
- the ECO display border lights up.

The additional range achieved as a result of your driving style in comparison to a driver with a very sporty driving style is shown under **Bonus fr. Start**. The range displayed does not indicate a fixed reduction in consumption.

### DYNAMIC SELECT switch

#### Function of the DYNAMIC SELECT switch

Use the DYNAMIC SELECT switch to change between the following drive programs:

- **I (Individual)**: individual settings
- **S+ (Sport Plus)**: particularly sporty driving style
- **S (Sport)**: sporty driving style
- **C (Comfort)**: comfortable and economical driving style
- **E (Eco)**: particularly economical driving style

Depending on the drive program selected, the following vehicle characteristics will change:

- Drive system
  - Engine and transmission management
  - Active Distance Assist DISTRONIC
- ESP®
- **Vehicles with AIR BODY CONTROL or DYNAMIC BODY CONTROL**: chassis
- Steering

### Selecting the drive program

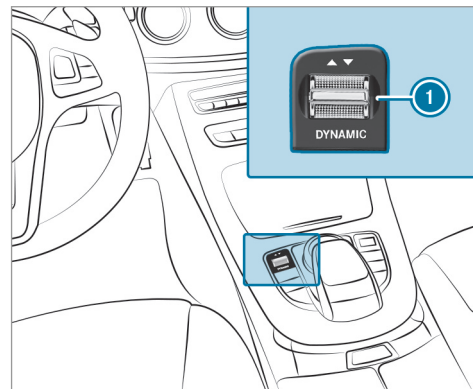

- ▶ Press DYNAMIC SELECT switch ① forwards or backwards. The drive program selected appears in the multifunction display.

### Configuring drive program I

Multimedia system:

↳ Vehicle ▶  DYNAMIC  
SELECT ▶▶ Individual

- ▶ Select the individual setting.

### Displaying vehicle data

Multimedia system:

↳ Vehicle ▶  DYNAMIC SELECT

- ▶ Select Vehicle Data.

### Displaying engine data

Multimedia system:

↳ Vehicle ▶  DYNAMIC SELECT

- ▶ Select Engine Data.

 The values for engine output and engine torque may deviate from the nominal values.

Items that can influence this are, for example:

- Engine speed

- Sea level
- Fuel grade
- Outside temperature

### Automatic transmission

#### DIRECT SELECT lever

#### Function of the DIRECT SELECT lever

 **WARNING** Risk of accident and injury due to children left unattended in the vehicle

If children are left unattended in the vehicle, they could:

- Open doors, thereby endangering other persons or road users
- Get out of the vehicle and be hit by oncoming traffic
- Operate vehicle equipment

In addition, the children could also set the vehicle in motion, for example, by:

- Releasing the parking brake
  - Shifting the transmission out of park position **P**
  - Starting the engine.
- ▶ Never leave children and animals unattended in the vehicle.
  - ▶ When leaving the vehicle, always take the SmartKey with you and lock the vehicle.
  - ▶ Keep the SmartKey out of the reach of children.

 **WARNING** Risk of accident due to incorrect gearshifting

If the engine speed is higher than the idle speed and you engage the transmission position **D** or **R**, the vehicle may accelerate sharply.

- ▶ If you engage the transmission position **D** or **R** always depress the brake

pedal firmly and do not accelerate at the same time.

Use the DIRECT SELECT lever to shift the transmission position. The current transmission position is displayed in the multifunction display.

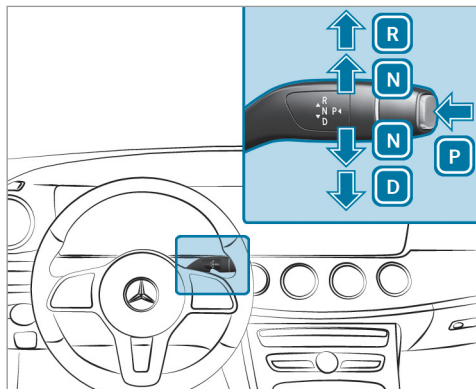

- P** Park position
- R** Reverse gear

- N** Neutral
- D** Drive position

#### Engaging reverse gear R

- ▶ Depress the brake pedal and push the DIRECT SELECT lever up past the first point of resistance. The transmission position display shows **R** in the multifunction display.

#### Shifting to neutral N

- ▶ Depress the brake pedal and push the DIRECT SELECT lever up or down to the first point of resistance. The transmission position display shows **N** in the multifunction display.

Subsequently releasing the brake pedal will allow you to move the vehicle freely, e.g. to push it or tow it away.

**If you want the automatic transmission to remain in neutral N even if the ignition is switched off:**

- ▶ Start the vehicle.

- ▶ Depress the brake pedal and shift to neutral **N**.
- ▶ Release the brake pedal.
- ▶ Switch the ignition off.
- ⓘ If you then exit the vehicle leaving the key in the vehicle, the automatic transmission remains in neutral **N**.

#### Engaging park position P

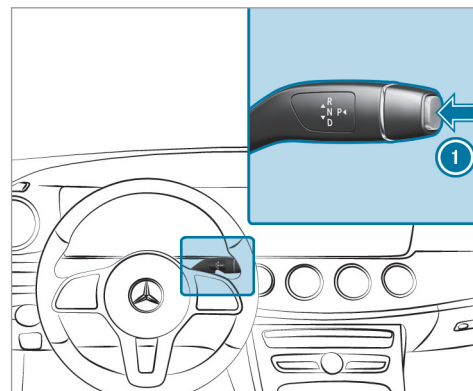

- ▶ Press button ①.

The transmission position display shows **P** in the multifunction display.

Park position **P** is engaged automatically if one of the following conditions is met:

- you switch the engine off with the transmission in position **D** or **R**.
- you open the driver's door when the vehicle is stationary or when driving at a very low speed and the transmission is in position **D** or **R**.

### Engaging drive position D

- ▶ Depress the brake pedal and push the DIRECT SELECT lever down past the first point of resistance.

The transmission position display shows **D** in the multifunction display.

When the automatic transmission is in transmission position **D**, it shifts the gears automatically. This depends on the following factors:

- The selected drive program
- The position of the accelerator pedal
- The road speed

### Manual gearshifting

**⚠ WARNING** Risk of skidding and of an accident due to shifting down on slippery road surfaces

If you shift down on slippery road surfaces to increase the engine braking effect, the drive wheels may lose traction.

- ▶ Do not shift down on slippery road surfaces to increase the engine braking effect.

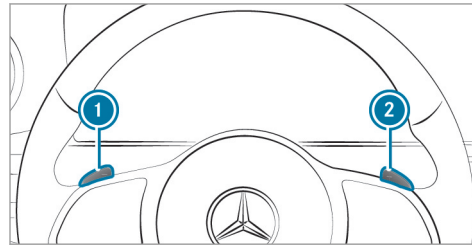

- ▶ **To activate:** pull steering wheel gearshift paddle ① or ②.

Manual gearshifting is activated for a short time. The current gear is displayed in the multifunction display.

- ▶ **To shift up:** pull steering wheel gearshift paddle ②.
- ▶ **To shift down:** pull steering wheel gearshift paddle ①.
- ▶ **To deactivate:** pull steering wheel gearshift paddle ② and hold it in place. The transmission position **D** appears in the multifunction display.

- ① If you select the **Manual** drive setting in drive program **I**, manual gearshifting is permanently activated.

### Shift recommendation

The gearshift recommendations assist you in adopting an economical driving style.

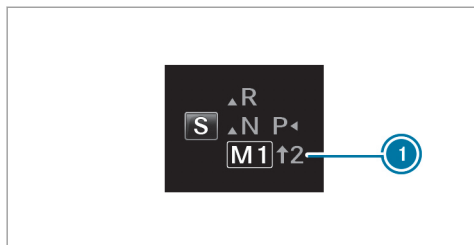

- ▶ If gearshift recommendation message ① is shown in the multifunction display, shift to the recommended gear.

### Using kickdown

- ▶ **Maximum acceleration:** depress the accelerator pedal beyond the pressure point.

During kickdown, you cannot shift gears using the steering wheel gearshift paddles. The automatic transmission shifts up to the next gear when the maximum engine speed is reached to protect the engine from overrevving.

- ▶ Ease off the accelerator pedal once the desired speed is reached.

### Glide mode function

With an anticipatory driving style, glide mode helps you to reduce fuel consumption.

Glide mode is characterized by the following:

- The combustion engine is disconnected from the drivetrain and the vehicle continues to roll in neutral.
- The transmission position **D** is displayed in green in the multifunction display.

Glide mode is activated if the following conditions are met:

- Drive program **E** is selected.
- The speed is within a suitable range
- The course of the road is suitable, e.g. no steep uphill or downhill gradients or tight bends.
- You are no longer depressing the accelerator or brake pedal.

- ① Glide mode can also be activated if you have selected the "Eco" setting for the drive (engine management) when in drive program **I**.

Glide mode is deactivated again if one of the conditions is no longer met.

**Vehicles with Driving Assistance Package, Active Distance Assist DISTRONIC or Active Brake Assist:** glide mode is also deactivated depending on the traffic situation and the vehicle then switches to overrun mode. This further reduces fuel consumption.

Glide mode can also be prevented by the following parameters:

- Uphill gradient
- Downhill gradient
- Temperature
- Height
- Speed
- Obstruction detection
- Operating status of the engine



## Refueling

### Refueling the vehicle

**⚠ WARNING** Risk of fire and explosion caused by fuel

Fuels are highly inflammable.

- ▶ You must avoid fire, open flames, creating sparks and smoking.
- ▶ Before refueling, switch off the engine and, if installed in your vehicle, the stationary heater.

**⚠ WARNING** Risk of injury from fuel

Fuels are poisonous and harmful to your health

- ▶ Do not swallow fuel or let it come into contact with skin, eyes or clothing.
- ▶ Do not inhale fuel vapors.
- ▶ Keep children away from fuel.

If you or other people come into contact with fuel, observe the following:

- ▶ Immediately rinse fuel off your skin with soap and water.
- ▶ If fuel comes into contact with your eyes, immediately rinse them thoroughly with clean water. Seek medical attention immediately.
- ▶ If you swallow fuel, seek medical attention immediately. Do not induce vomiting.
- ▶ Change immediately out of clothing that has come into contact with fuel.

**⚠ WARNING** Risk of explosion or fire due to electrostatic charge

Electrostatic charge can cause sparks and thereby ignite fuel vapors.

- ▶ Always touch the metal vehicle body before opening the fuel filler cap or touching the pump nozzle.

This discharges any electrostatic charge that may have built up.

**! NOTE** Damage caused by the wrong fuel

Fuel that does not conform to the required quality can lead to increased wear as well as damage to the engine and exhaust system.

- ▶ Only use the fuel recommended.

**! NOTE** Damage caused by the wrong fuel

Vehicles with a gasoline engine:

Even small amounts of the wrong fuel could result in damage to the fuel system, the engine and the emission control system.

- ▶ The RON octane rating can be found on the fuel filler flap.
- ▶ Only refuel with low-sulfur unleaded fuel.

This fuel may contain up to 10 % ethanol. Your vehicle is suitable for use with E10 fuel.

Do not refuel using:

- Diesel

- E15, E85, E100
- Gasoline containing methanol (M15, M30, M85, M100)
- Gasoline with additives containing metal

If you accidentally refuel with the wrong fuel:

- ▶ Do not switch the ignition on.
- ▶ Consult a qualified specialist workshop.

**!** **NOTE** Do not use diesel to refuel vehicles with a gasoline engine.

If you accidentally refuel with the wrong fuel:

- Do not switch on the ignition. Otherwise fuel can enter the engine.  
Even small amounts of the wrong fuel could result in damage to the fuel system and the engine. The repair costs are high.

- ▶ Contact a qualified specialist workshop.
- ▶ Have the fuel tank and fuel lines drained completely.

**!** **NOTE** Damage to the fuel system caused by overfilled fuel tanks.

- ▶ Only fill the fuel tank until the pump nozzle switches off.

**!** **NOTE** Fuel may spray out when you remove the fuel pump nozzle.

- ▶ Only fill the fuel tank until the pump nozzle switches off.

**Requirements:**

- Unlock the vehicle.
- ① Do not get into the vehicle again during the refueling process. Otherwise, electrostatic charge could build up again.

Observe the notes on operating fluids (→ page 387).

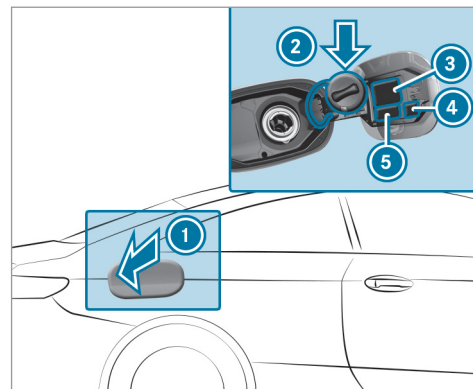

- ① Fuel filler flap
- ② Bracket for the fuel filler cap
- ③ Tire pressure table
- ④ QR code for rescue card
- ⑤ Fuel type

- ▶ Press fuel filler flap ①.
- ▶ Turn the fuel filler cap anti-clockwise and remove it.

- ▶ Insert the fuel filler cap into holder ②.
- ▶ Completely insert the fuel pump nozzle into the tank filler neck, hook in place and refuel.
- ▶ Only fill the fuel tank until the fuel pump nozzle switches off.

## Parking

### Switching off the vehicle

**⚠ WARNING** Risk of fire caused by hot exhaust system parts

Flammable material such as leaves, grass or twigs may ignite if they come into contact with hot parts of the exhaust system or exhaust gas flow.

- ▶ Park the vehicle so that no flammable material can come into contact with hot vehicle components.
- ▶ In particular, do not park on dry grass-land or harvested grain fields.

**⚠ WARNING** Risk of accident and injury due to children left unattended in the vehicle

If you leave children unaccompanied in the vehicle, they may be able to set the vehicle in motion, for example by:

- Releasing the parking brake.
- Shifting the transmission out of park position **P**.
- Starting the engine.

In addition, they may operate vehicle equipment.

- ▶ Never leave children and animals unattended in the vehicle.
- ▶ When leaving the vehicle, always take the SmartKey with you and lock the vehicle.

**! NOTE** Damage to the vehicle or the drivetrain caused by the vehicle rolling away

- ▶ Always properly secure the vehicle against rolling away.

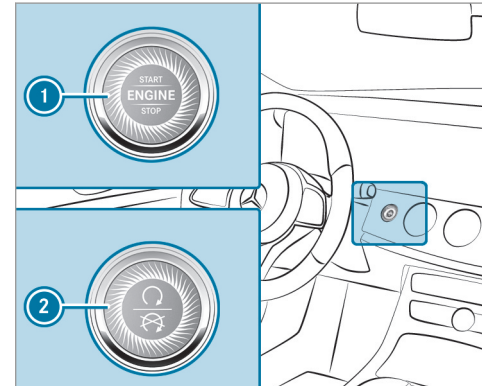

- ▶ On uphill or downhill inclines, turn the front wheels towards the curb.
- ▶ Select transmission position **P**.

- ▶ Apply the electric parking brake.
- ▶ Press button ① (USA) or ② (Canada) once.
- ① When you switch off the vehicle, you can still operate the side windows for five minutes.

### Garage door opener

#### Programming buttons for the garage door opener

**⚠ WARNING** Risk of exhaust gas poisoning

Combustion engines emit poisonous exhaust gases such as carbon monoxide. Inhaling these exhaust gases causes poisoning.

- ▶ Never leave the engine running in an enclosed space without sufficient ventilation.

**⚠ WARNING** Risk of injury and entrapment when opening the garage door using the garage door opener

When you operate or program the garage door with the integrated garage door opener,

persons in the range of movement of the garage door can become trapped or struck by the garage door.

- ▶ When using the integrated garage door opener, always make sure that nobody is within the sweep of the garage door.

Only operate the garage door opener on the following garage doors:

- Garage doors with a safety stop and reversing feature.
- Garage doors which conform to the current U.S. safety standards.

#### Requirements:

- The vehicle is parked outside of the garage.
- The engine is switched off.

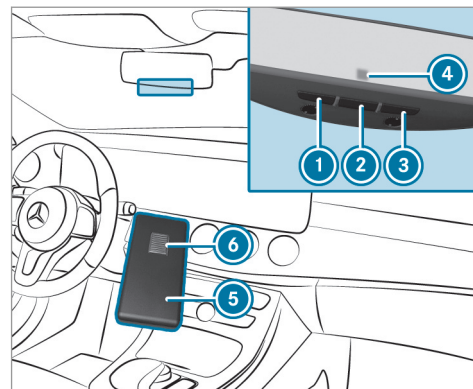

- ▶ Check if the transmitter frequency of the remote control has the frequency range of 280 to 868 MHz.

Radio equipment approval number:

- NZLMUAHL5 (USA)
- 4112A-MUAHL5 (Canada)

- ▶ Press and hold button ①, ② or ③ that you wish to program. Indicator lamp ④ flashes yellow.
- ⓘ It can take up to 20 seconds before the indicator lamp flashes yellow.
- ▶ Release the previously pressed button. Indicator lamp ④ continues to flash yellow.
- ▶ Point remote control ⑤ at a distance of 1 in (1 cm) to 3 in (8 cm) towards buttons ①, ② or ③.
- ▶ Press and hold button ⑥ of remote control ⑤ until:
  - Indicator lamp ④ lights up green continuously. Programming is complete.
  - Indicator lamp ④ flashes green. Programming was successful. Additionally, synchronization of the rolling code with the garage door system must also be carried out.
- ▶ If indicator lamp ④ does not light up or flash green: repeat the procedure.
- ▶ Release all of the buttons.

- ⓘ The remote control for the garage door drive is not included in the scope of delivery of the garage door opener.

### Synchronizing the rolling code

#### Requirements:

- The garage door system uses a rolling code.
- The vehicle must be within range of the garage door or exterior gate drive.
- The vehicle as well as persons and objects, are located outside the sweep of the garage door.

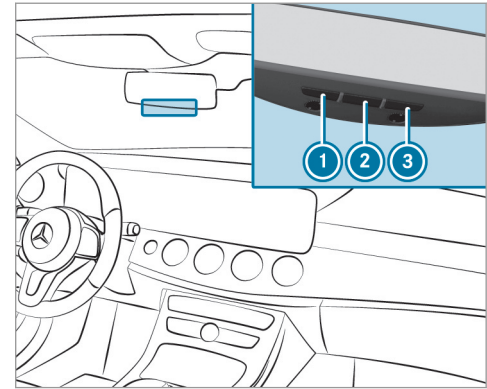

- ▶ Press the programming button on the door drive unit. Initiate the next step within approximately 30 seconds.
- ▶ Press previously programmed button ①, ② or ③ repeatedly, until the door closes. When the door closes, programming is completed.

- i Please also read the operating instructions for the garage door drive.

### Troubleshooting when programming the remote control

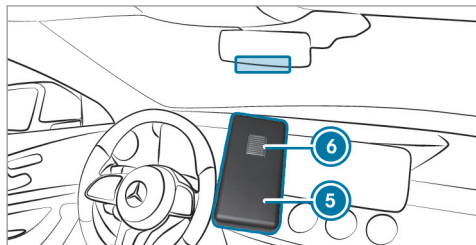

- ▶ Check if the transmitter frequency of remote control ⑤ is supported.
- ▶ Replace the batteries in remote control ⑤.
- ▶ Hold remote control ⑤ at various angles at a distance between 1 in (1 cm) to 3 in (8 cm) in front of the inside rearview mirror. You should test every position for at least 25 seconds before trying another position.

- ▶ Hold remote control ⑤ at the same angles at various distances in front of the inside rearview mirror. You should test every position for at least 25 seconds before trying another position.
- ▶ Note that some remote controls transmit only for a limited period, press button ⑥ on remote control ⑤ again before transmission ends.
- ▶ Align the antenna line of the garage door opener unit with the remote control.

- i Support and additional information on programming:

- On the toll free HomeLink® Hotline on 1-800-355-3515.
- On the Internet at <http://www.homelink.com/mercedes>.

### Opening/closing the garage door

#### Requirements

- The corresponding button is programmed to operate the garage door.

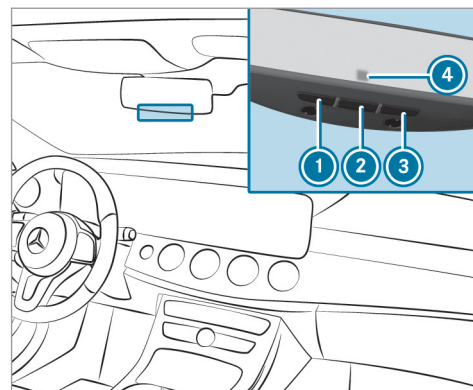

- ▶ Press and hold buttons ①, ② or ③ until the garage door opens or closes.
- ▶ If indicator lamp ④ flashes yellow after approximately 20 seconds: press and hold the previously pressed button again until the garage door opens or closes.

### Clearing the garage door opener memory

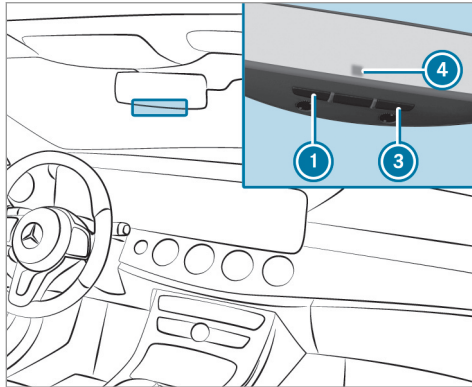

- ▶ Press and hold buttons ① and ③.
- ▶ Indicator lamp ④ lights up yellow.
- ▶ If indicator lamp ④ flashes green: release buttons ① and ③.

### Radio equipment approval numbers for the garage door opener

#### Radio equipment approval numbers

Country	Radio type approval number
Egypt	TAC.2511151293.WIR
Andorra	CE
Australia	R-NZ
Barbados	MED1578
Chile	2488/DFRS20576/F-74
European Union	CE
Gibraltar	CE
Iceland	CE
Jordan	TRC/LPD/2015/299
Canada	IC: 4112A-MUAHL5
Kuwait	CE

Country	Radio type approval number
Liechtenstein	CE
Mexico	RCPGEMU15-0448
Monaco	CE
New Zealand	R-NZ
Norway	CE
Russian Federation	not required
Saudi Arabia	TA 10525
Switzerland	CE

Country	Radio type approval number
South Africa	 TA-2015/1386
Turkey	not required
United Arab Emirates	ER41849/15 Dealer No: DA35176/14
United States	FCC ID: NZLMUAHL5

### Brazil



Este equipamento opera em caráter secundário, isto é, não tem direito à proteção contra interferência prejudicial, mesmo de estações do mesmo tipo, e não pode causar interferência a sistemas operando em caráter primário.

Para maiores informações acessar [www.anatel.gov.br](http://www.anatel.gov.br)

Further information on the declaration of conformity for wireless vehicle components (→ page 23).

### Electric parking brake

#### Electric parking brake function (applying automatically)

**⚠ WARNING** Risk of accident and injury due to children left unattended in the vehicle

If you leave children unaccompanied in the vehicle, they may be able to set the vehicle in motion, for example by:

- Releasing the parking brake.
- Shifting the transmission out of park position **P**.
- Starting the engine.

In addition, they may operate vehicle equipment.

- ▶ Never leave children and animals unattended in the vehicle.
- ▶ When leaving the vehicle, always take the SmartKey with you and lock the vehicle.



The electric parking brake is applied if the transmission is in position **P** and one of the following conditions is fulfilled:

- The engine is switched off.
  - The seat belt tongue is not inserted in the seat belt buckle of the driver's seat and the driver's door is opened.
- i** To prevent application: pull the handle of the electric parking brake.

In the following situations, the electric parking brake is also engaged:

- Active Distance Assist DISTRONIC is bringing the vehicle to a standstill.
- The HOLD function is keeping the vehicle stationary.
- Active Parking Assist is keeping the vehicle stationary.

This is only the case if one of the following conditions is also fulfilled:

- The engine is switched off.

- The seat belt tongue is not inserted in the seat belt buckle of the driver's seat and the driver's door is opened.
- There is a system malfunction.
- The power supply is insufficient.
- The vehicle is stationary for a lengthy period.

When the electric parking brake is applied, the **PARK** (USA) or **(P)** (Canada) indicator lamp lights up in the instrument cluster.

The electric parking brake is not automatically applied if the engine is switched off by the ECO start/stop function.

#### **Electric parking brake function (releasing automatically)**

The electric parking brake is released when the following conditions are fulfilled:

- The engine is running.
- The seat belt tongue is inserted into the seat belt buckle of the driver's seat.
- The transmission is in position **D** or **R** and you depress the accelerator pedal or you

shift from transmission position **P** to **D** or **R**.

- If the transmission is in position **R**, the trunk lid must be closed.

If the seat belt tongue is not inserted into the seat belt buckle of the driver's seat, the following conditions must be fulfilled:

- The driver's door is closed.
- You move the transmission out of transmission position **P** or you have previously driven faster than 2 mph (3 km/h).
- If the transmission is in position **R**, the trunk lid must be closed.

If the electric parking brake is released, the **PARK** (USA) or **(P)** (CANADA) indicator lamp in the instrument cluster goes out.

## Applying or releasing the electric parking brake manually

### Applying

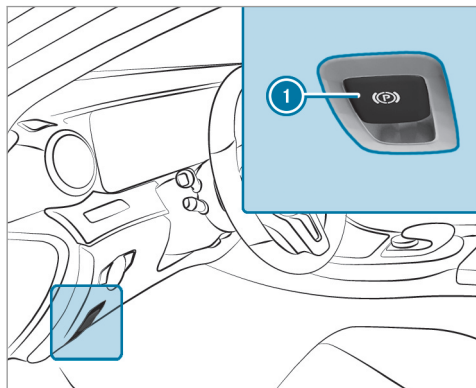

- ▶ Push handle ①.  
The **PARK** (USA) or **(P)** (Canada) indicator lamp appears in the instrument cluster.

- ① The electric parking brake is only securely applied if the indicator lamp is lit continuously.

### Releasing

- ▶ Switch on the ignition.
- ▶ Pull handle ①.  
The **PARK** (USA) or **(P)** (Canada) indicator lamp in the instrument cluster goes out.

### Emergency braking

- ▶ Press and hold handle ①.  
When the vehicle has been braked to a standstill, the electric parking brake is applied. The **PARK** (USA) or **(P)** (Canada) indicator lamp appears in the instrument cluster.

### Notes on parking the vehicle for a long period

If you leave the vehicle parked for longer than four weeks, the disconnected battery may be damaged by deep discharge.

If you leave the vehicle parked for longer than six weeks, it may suffer damage as a result of lack of use.

- ① Further information can be obtained at a qualified specialist workshop.

### Standby mode (extension of the starter battery's period out of use)

#### Standby mode function

If standby mode is activated, the vehicle can be parked for an extended period of time without losing power.

Standby mode is characterized by the following:

- the starter battery is preserved.
- the maximum period out of use is displayed in the multimedia system display.
- functions such as interior protection or tow-away protection are not available.
- the connection to online services is interrupted.

If the following conditions are fulfilled, standby mode can be activated or deactivated using the multimedia system:

- the engine is switched off.
- the ignition is switched on.

Exceeding the vehicle's displayed period out of use may cause inconvenience, i.e. it cannot be guaranteed that the starter battery will reliably start the engine.

The starter battery must be charged first in the following situations:

- the vehicle's period out of use must be extended.
  - the **Battery Charge Insufficient for Standby Mode** message appears in the multimedia system display.
- i** Standby mode is automatically deactivated when the ignition is switched on.

### Activating or deactivating standby mode

Multimedia system:

↳ **Vehicle** ▶  **Vehicle Settings** ▶ **Standby Mode**

- ▶ Activate  or deactivate  the function. When you activate the function, a prompt appears.
- ▶ Select **Yes**. Standby mode is activated.

### Driving and driving safety systems

#### Driving systems and your responsibility

Your vehicle is equipped with driving systems which assist you in driving, parking and maneuvering the vehicle. The driving systems are tools and do not relieve you of your responsibility. Pay attention to the traffic conditions at all times and intervene when necessary. Be aware of the limitations regarding the safe use of these systems.

### Function of the radar sensors

Some driving and driving safety systems use radar sensors to monitor the area in front of, behind or next to the vehicle (depending on the vehicle's equipment).

Depending on the vehicle's equipment, the radar sensors are integrated behind the bumpers and/or behind the radiator grille. Keep these parts free of dirt, ice and slush (→ page 327). The sensors must not be covered, for example by bicycle racks, overhanging loads or radar-reflecting stickers. Following an impact and in the event of associated damage, which may not be visible, to the bumpers or radiator grille, have the function of the radar sensors checked at a qualified specialist workshop. The driver assistance system may no longer work properly.

## Overview of driving systems and driving safety systems

In this section, you will find information about the following driving systems and driving safety systems:

- 360° Camera (→ page 181)
- ABS (**A**nti-**l**ock **B**raking **S**ystem) (→ page 154)
- Active Distance Assist DISTRONIC (→ page 162)
- AIR BODY CONTROL (→ page 171)
- Active Brake Assist (→ page 156)
- Active Lane Keeping Assist (→ page 195)
- ATTENTION ASSIST (→ page 189)
- BAS (**B**rake **A**ssist **S**ystem) (→ page 154)
- EBD (**E**lectronic **B**rake force **D**istribution) (→ page 155)
- ESP® (**E**lectronic **S**tability **P**rogram)
- Hill Start Assist
- HOLD function (→ page 170)
- STEER CONTROL (→ page 155)

- Active Steering Assist (→ page 167)
- Active Parking Assist (→ page 184)
- Parking Assist PARKTRONIC (→ page 175)
- Rear view camera (→ page 178)
- Cruise control (→ page 160)
- Blind Spot Assist and Active Blind Spot Assist (→ page 193)
- Traffic Sign Assist (→ page 191)

### Functions of ABS (Anti-lock Brake System)

ABS regulates the brake pressure in critical driving situations:

- During braking, e.g. at maximum full-stop braking or insufficient traction of the tires, the wheels are prevented from blocking.
- Vehicle steerability while braking is ensured.

If ABS intervenes when braking, you will feel a pulsing in the brake pedal. The pulsating brake pedal can be an indication of hazardous road conditions and can serve as a reminder to take extra care while driving.

### System limitations

- ABS is active from speeds of approx. 5 mph (8 km/h).
- ABS may be impaired or may not function if a malfunction has occurred and the yellow  ABS warning lamp lights up continuously in the instrument cluster after the engine is started.

### Function of BAS (Brake Assist System)

**▲ WARNING** Risk of an accident caused by a malfunction in BAS (Brake Assist System)

If BAS is malfunctioning, the braking distance in an emergency braking situation is increased.

▶ Depress the brake pedal with full force in emergency braking situations. ABS prevents the wheels from locking.

BAS supports your emergency braking situation with additional brake force.

If you depress the brake pedal quickly, BAS is activated:

- BAS automatically boosts the brake pressure.
- BAS can shorten the braking distance.
- ABS prevents the wheels from locking.

The brakes will function as usual once you release the brake pedal. BAS is deactivated.

### Activating/deactivating ESP® (Electronic Stability Program)

Multimedia system:

↳ Vehicle ▶  Assistance ▶ ESP

▶ Activate  or deactivate  the function.

ESP® is deactivated if the  ESP® OFF warning lamp lights up continuously in the instrument cluster.

Observe the information on warning lamps and display messages which may be shown in the instrument cluster.

### Functions of ESP® Crosswind Assist

ESP® Crosswind Assist detects sudden gusts of side wind and helps the driver to keep the vehicle in the lane:

- ESP® Crosswind Assist is active at vehicle speeds between 50 mph (80 km/h) and 125 mph (200 km/h) when driving straight ahead or cornering slightly.
- The vehicle is stabilized by means of individual brake application on one side.

### Function of EBD (Electronic Brake force Distribution)

EBD is characterized by the following:

- Monitoring and regulating the brake pressure on the rear wheels.
- Improved driving stability when braking, especially on bends.

### STEER CONTROL function

STEER CONTROL helps you by transmitting a noticeable steering force to the steering wheel in the direction required for vehicle stabilization.

This steering recommendation is given particularly in the following situations:

- Both right wheels or both left wheels are on a wet or slippery road surface when you brake.
- The vehicle starts to skid.

### System limitations

STEER CONTROL may be impaired or may not function in the following situations:

- ESP® is deactivated.
- ESP® is malfunctioning.
- The steering is malfunctioning.

If ESP® is malfunctioning, you will be assisted further by the electric power steering.

## Function of Active Brake Assist

Active Brake Assist consists of:

- Distance warning function
- Autonomous braking function
- Situation-dependent braking assistance
- **Vehicles with Driving Assistance Package:** Evasive Steering Assist

Active Brake Assist can help you to minimize the risk of a collision with vehicles or pedestrians or to reduce the effects of such a collision.

If Active Brake Assist has detected a risk of collision, you will be warned visually and acoustically.

If you do not react to the visual and audible collision warning, autonomous braking can be initiated in critical situations.

In especially critical situations, Active Brake Assist can initiate autonomous braking directly. In this case, the visual and acoustic warning occurs simultaneously with the braking application.

If you apply the brake yourself in a critical situation or apply the brake during autonomous braking, situation-dependent braking assistance occurs. This increases the brake pressure up to maximum full-stop braking if necessary.

If the autonomous braking function or the situation-dependent braking assistance is triggered, additional preventive measures for occupant protection (PRE-SAFE®) may also be initiated, if the vehicle is equipped with these.

**⚠ WARNING** Risk of an accident caused by limited detection performance of Active Brake Assist

Active Brake Assist cannot always clearly identify objects and complex traffic situations.

In such cases, Active Brake Assist might:

- Give a warning or brake without reason
- Not give a warning or not brake

▶ Always pay careful attention to the traffic situation; do not rely on Active Brake Assist alone. Active Brake Assist is only

an aid. The driver is responsible for maintaining a suitable distance to the vehicle in front, vehicle speed and for braking in good time.

▶ Be prepared to brake or swerve if necessary.

Also observe the system limitations of Active Brake Assist.

### The individual subfunctions are available in the following speed ranges: Distance warning function

The distance warning function issues a warning at speeds:

- From approximately 4 mph (7 km/h), if your vehicle is critically close to a vehicle or pedestrian. An intermittent warning tone sounds and the  distance warning lamp lights up in the instrument cluster.

Brake immediately or take evasive action, provided it is safe to do so and the traffic situation allows this.

The distance warning function can aid you in the following situations with an intermittent warning tone and a warning lamp:

	Vehicles traveling in front	Stationary vehicles	Crossing vehicles	Crossing pedestrians	Stationary pedestrians
Vehicles without Driving Assistance package	up to approx. 155 mph (250 km/h)	up to approx. 50 mph (80 km/h)	no reaction	up to approx. 37 mph (60 km/h)	no reaction
Vehicles with Driving Assistance package	up to approx. 155 mph (250 km/h)	up to approx. 62 mph (100 km/h)	up to approx. 43 mph (70 km/h)	up to approx. 43 mph (70 km/h)	up to approx. 43 mph (70 km/h)

#### Autonomous braking function

The autonomous braking function may intervene at speeds starting from approximately 4 mph (7 km/h) in the following situations:

	Vehicles traveling in front	Stationary vehicles	Crossing vehicles	Crossing pedestrians	Stationary pedestrians
Vehicles without Driving Assistance package	up to approx. 124 mph (200 km/h)	up to approx. 31 mph (50 km/h)	no reaction	up to approx. 37 mph (60 km/h)	no reaction
Vehicles with Driving Assistance package	up to approx. 155 mph (250 km/h)	up to approx. 62 mph (100 km/h)	up to approx. 43 mph (70 km/h)	up to approx. 43 mph (70 km/h)	up to approx. 43 mph (70 km/h)

**Situation-dependent braking assistance**

Situation-dependent braking assistance may intervene at speeds starting from approximately 4 mph (7 km/h) in the following situations:

	Vehicles traveling in front	Stationary vehicles	Crossing vehicles	Crossing pedestrians	Stationary pedestrians
Vehicles without Driving Assistance package	up to approx. 155 mph (250 km/h)	up to approx. 50 mph (80 km/h)	no reaction	up to approx. 37 mph (60 km/h)	no reaction
Vehicles with Driving Assistance package	up to approx. 155 mph (250 km/h)	up to approx. 62 mph (100 km/h)	up to approx. 43 mph (70 km/h)	up to approx. 43 mph (70 km/h)	up to approx. 43 mph (70 km/h)

**Canceling a brake application of Active Brake Assist**

You can cancel a brake application of Active Brake Assist at any time by:

- Depressing the accelerator pedal fully.
- Releasing the brake pedal.

Active Brake Assist may cancel the brake application when one of the following conditions is fulfilled:

- You maneuver to avoid the obstacle.
- There is no longer a risk of collision.

- An obstacle is no longer detected in front of your vehicle.

**Evasive Steering Assist (only vehicles with Driving Assistance package)**

Evasive Steering Assist has the following characteristics:

- Can detect stationary or crossing pedestrians.
- Can assist the driver with additional steering assistance if it detects a swerving maneuver.

- Can be activated by an abrupt steering movement during a swerving maneuver.
- Can assist during swerving and straightening of the vehicle.
- Can react from a speed of approximately 12 mph (20 km/h) up to a speed of approximately 43 mph (70 km/h).
- You can prevent the assistance at any time by actively steering.



**⚠ WARNING** Risk of an accident despite Evasive Steering Assist

Evasive Steering Assist cannot always clearly identify objects and complex traffic situations.

In addition, the steering support of Evasive Steering Assist is generally not sufficient to avoid a collision.

In such cases Evasive Steering Assist can:

- give an unnecessary warning or provide assistance
  - not give a warning or not provide assistance
- ▶ Always pay careful attention to the traffic situation; do not rely on Evasive Steering Assist alone.
- ▶ Be ready to brake and take evasive action if necessary.
- ▶ Prevent the assistance by actively steering in non-critical driving situations.

- ▶ Drive at an appropriate speed if pedestrians are close to the path of your vehicle.

Also observe the system limitations of Evasive Steering Assist.

### System limitations

The system may be impaired or may not function in the following situations:

- In snow, rain, fog, heavy spray, if there is glare, in direct sunlight or in greatly varying light conditions.
- If the sensors are dirty, misted up, damaged or covered.
- If the sensors malfunction due to other radar source interference, for example strong radar reflections in parking garages.
- If a loss of tire pressure or a defective tire has been detected and displayed.

The system may not react correctly:

- In complex traffic situations where objects cannot always be clearly identified.

- To pedestrians or vehicles if they move quickly into the sensor detection range.
- To pedestrians who are hidden by other objects.
- If the typical outline of a pedestrian cannot be distinguished from the background.
- If a pedestrian is not recognized as such, e.g. due to special clothing or other objects.
- On bends with a tight radius.

### Setting Active Brake Assist

Multimedia system:

➔ Vehicle ➔  Assistance ➔ Active Brake Assist

**Vehicles without Driving Assistance package:** The settings can be made after starting the vehicle.

**Vehicles with Driving Assistance package:** The settings can be made when the ignition is switched on.

-  It is recommended that you always leave Active Brake Assist activated.

Select one of the following settings:

- ▶ **Early:** your selection is retained when the vehicle is next started.
  - ▶ **Medium:** your selection is retained when the vehicle is next started.
  - ▶ **Late:** your selection is retained when the vehicle is next started.
  - ▶ **Off:**  
**Vehicles without Driving Assistance package:** The distance warning function and the autonomous braking function are deactivated. When the vehicle is next started, the middle setting is automatically selected.  
**Vehicles with Driving Assistance package:** The distance warning function and the autonomous braking function are deactivated. Evasive Steering Assist is unavailable. When the ignition is next started, the middle setting is selected automatically and Evasive Steering Assist is available.
- ① When Active Brake Assist is deactivated, the  symbol appears in the assistance graphic in the multifunction display.

### Speed control cruise control

#### Function of cruise control

Cruise control accelerates and brakes the vehicle automatically in order to maintain a previously stored speed.

If you accelerate to overtake, for example, the stored speed is not deleted. If you remove your foot from the accelerator pedal after overtaking, cruise control will resume speed regulation back to the stored speed.

You can operate cruise control with the cruise control lever.

If you fail to adapt your driving style, cruise control can neither reduce the risk of an accident nor override the laws of physics. It cannot take into account road, weather or traffic conditions. Cruise control is only an aid. You are responsible for the distance to the vehicle in front, for vehicle speed, for braking in good time and for staying in lane.

#### System limitations

Cruise control may be unable to maintain the stored speed on uphill gradients. The stored speed is resumed when the gradient evens out.

Change into a lower gear in good time on long and steep downhill gradients. Take particular note of this when driving a laden vehicle. By doing so, you will make use of the braking effect of the engine. This relieves the load on the brake system and prevents the brakes from overheating and wearing too quickly.

Do not use cruise control in the following situations:

- In traffic situations which require frequent changes of speed, e.g. in heavy traffic, on winding roads.
- On slippery roads. Accelerating can cause the drive wheels to lose traction and the vehicle could then skid.
- If you are driving when visibility is poor.

#### Operating cruise control

 **WARNING** Risk of accident due to unknown stored speed

If you call up the stored speed and this is lower than your current speed, the vehicle decelerates.

If you do not know the stored speed, the vehicle could decelerate unexpectedly.

- ▶ Take into account the traffic situation before calling up the stored speed.
- ▶ If the stored speed is not known, store the desired speed again.

Change into a lower gear in good time on long and steep downhill gradients. Take particular note of this when driving a laden vehicle. By doing so, you will make use of the braking effect of the engine. This relieves the load on the brake system and prevents the brakes from overheating and wearing too quickly.

#### Requirements:

- Cruise control is selected.
- ESP® must be activated, but not intervening.
- The driving speed must be at least 15 mph (20 km/h).

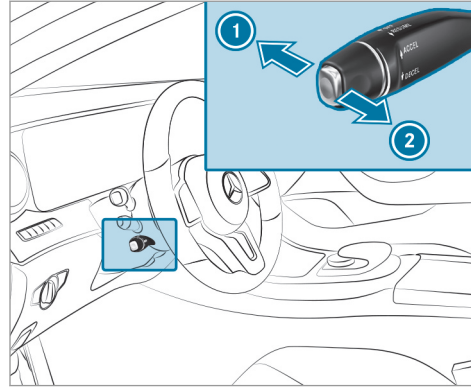

- ▶ Store current speed ② (once after starting the vehicle).

or

- ▶ Call up stored speed ②.
- ▶ Deactivate cruise control ①.

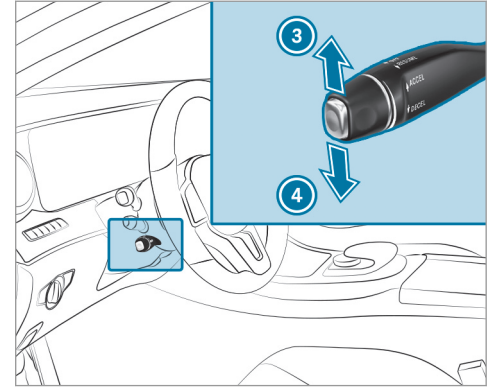

- ▶ Press the lever briefly: the stored speed is increased ③ or reduced ④ by 1 mph (1 km/h).

or

- ▶ Press the lever beyond the pressure point: the stored speed is increased ③ or reduced ④ by 5 mph (10 km/h).

If cruise control has been deactivated, the current driven speed is adopted with ③ or ④.

- ① If you brake, deactivate ESP® or if ESP® intervenes, cruise control is deactivated. When you switch off the vehicle, the last speed stored is cleared.

### Active Distance Assist DISTRONIC

#### Function of Active Distance Assist DISTRONIC

##### Active Distance Assist DISTRONIC

- Maintains the set speed and accelerates or decelerates the vehicle if the distance from the vehicle in front permits.
- Assists you in maintaining the distance from the vehicle in front and can bring your vehicle to a standstill if necessary.
- Brakes your vehicle with up to 50 % of the maximum possible braking power. If greater deceleration performance is required, a visual and acoustic warning is given and you must then intervene yourself.
- **Vehicles with Driving Assistance Package, Active Parking Assist and COMAND:** When driving in stop-start traffic, the driver is

supported by extended automatic re-start in traffic jams.

- **Vehicles with Driving Assistance Package:** Responds to stationary vehicles in urban speed ranges (except bicycles, motorcycles and pedestrians) if conditions are sufficient to enable detection.

If you fail to adapt your driving style, Active Distance Assist DISTRONIC can neither reduce the risk of an accident nor override the laws of physics. It cannot take into account road, weather or traffic conditions. Active Distance Assist DISTRONIC is only an aid. You are responsible for the distance to the vehicle in front, for vehicle speed, for braking in good time and for staying in lane.

If all activation conditions are met, you can activate Active Distance Assist DISTRONIC during a journey or while stationary. When Active Distance Assist DISTRONIC is activated, a speed is stored which the driver can increase or reduce at any time. The speed can be adjusted between 15 mph (20 km/h) and 120 mph (200 km/h).

#### **Vehicles with the Driving Assistance Pack-**

**age:** The speed can be adjusted between 15 mph (20 km/h) and 130 mph (210 km/h).

**Vehicles with Driving Assistance Package, Active Parking Assist and COMAND:** Up to 30 seconds after stopping, the vehicle automatically follows the vehicle ahead without the intervention of the driver. This is only possible if the vehicle is traveling on a motorway or a high-speed major road. If an obstacle is detected in front of the vehicle during the driving-off procedure, a takeover warning is given. Acceleration is reduced, the driver is given a visual and acoustic warning and must stop the vehicle before reaching the obstacle or take evasive action.

#### **Vehicles with the Driving Assistance Pack-**

**age:** In conjunction with navigation systems, Active Distance Assist DISTRONIC prevents prohibited overtaking on the right at speeds over 50 mph (80 km/h) in right-hand traffic and overtaking on the left in left-hand traffic on freeways and high-speed major roads.

If you activate the turn signal indicator to change lanes, the vehicle will accelerate more briskly to the set speed under the following conditions:

- Active Distance Assist DISTRONIC is activated.
- If the driving speed is higher than 45 mph (70 km/h).
- If the driven speed drops below the stored speed.
- The system cannot detect a vehicle in the relevant area of the overtaking lane.

#### **Vehicles with Driving Assistance Package and Traffic Sign Assist:**

Active Distance Assist DISTRONIC also has the Active Speed Limit Assist function. This function can be configured in the multimedia system. If a change in the speed limit is detected and Active Distance Assist DISTRONIC is activated, Active Distance Assist DISTRONIC assumes this new speed.

The driven speed is adapted when the vehicle is level with the traffic signs. The speed limit display in the Instrument Display is always updated when the vehicle is level with the traffic sign.

If Active Distance Assist DISTRONIC has been put into passive mode by pressing the accelera-

tor pedal, only speed limits which are higher than the set speed are adopted.

Pulling the cruise control lever will set the displayed speed limit as the speed, provided that:

- Active Speed Limit Assist has been activated in the multimedia system and
- Active Distance Assist DISTRONIC has been activated.

If no speed limit is displayed when the lever is operated, the speed set by the driver is adopted.

#### **Drive program**

The DYNAMIC SELECT switch allows you to change the driving style of Active Distance Assist DISTRONIC. Depending on which drive program is selected, the driving characteristics can be geared towards fuel economy, comfort or dynamic performance (→ page 138).

#### **System limitations**

##### **Vehicles with the Driving Assistance Pack-**

**age:** Active Distance Assist DISTRONIC is active in the 0 mph (0 km/h) to 130 mph (210 km/h) speed range.

The system may be impaired or may not function in the following instances, for example:

- In snow, rain, fog, heavy spray, if there is glare, in direct sunlight or in greatly varying light conditions.
- The windshield in the area of the camera is dirty, misted up, damaged or covered.
- If the radar sensors are dirty or covered.
- On slippery roads, braking or accelerating can cause the drive wheels to lose traction and the vehicle could then skid.
- In parking garages, toll stations or on roads with steep uphill or downhill gradients.

Do not use Active Distance Assist DISTRONIC in these situations.

#### **Tips**

Pay particular attention in the following traffic situations. In such situations, brake if necessary. Active Distance Assist DISTRONIC is then deactivated:

- When cornering, entering and exiting a bend.
- When not driving in the center of the lane.

- When other vehicles are changing lane.
- If there are narrow vehicles.
- If there are obstacles and stationary vehicles.
- If there are crossing vehicles, pedestrians, motorcyclists or cyclists.

**Display of Active Distance Assist DISTRONIC in the assistance graphic and in the speedometer**

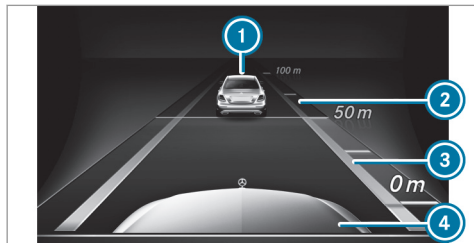

- ① Vehicle ahead
- ② Distance indicator

- ③ Set specified distance
- ④ Your vehicle

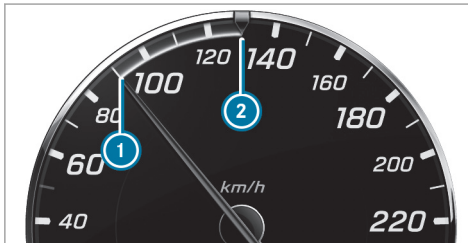



- ① Speed of vehicle ahead
- ② Stored speed

**Displays in the multifunction display**

When activating Active Distance Assist DISTRONIC or when changing the stored speed, the new stored speed is shown for around five seconds in the multifunction display  50 mph (70 km/h).

When Active Distance Assist DISTRONIC is active, the set stored speed is displayed next to

the  symbol. When distance control is active, the symbol is shown in green.

**Vehicles with the Driving Assistance Package:** On freeways or high-speed major roads the  symbol is displayed cyclically when the vehicle is ready to pull away.

**Vehicles with Active Speed Limit Assist:** If a speed limit is automatically adopted, this is shown as the stored speed with the  symbol.

**Operating Active Distance Assist DISTRONIC**

**⚠ WARNING** Risk of accident if detection function of Active Distance Assist DISTRONIC is impaired

Active Distance Assist DISTRONIC does not react:

- To people or animals.
- To stationary obstacles on the road, e.g. stopped or parked vehicles (vehicles without the Driving Assistance Package).

- To stationary obstacles on the road, e.g. stopped or parked vehicles, if conditions are not sufficient to enable detection (vehicles with the Driving Assistance Package).
- To oncoming vehicles and crossing traffic.

Active Distance Assist DISTRONIC can neither give warnings nor intervene in such situations.

- ▶ Always carefully observe the traffic conditions and be ready to brake at all times.

**⚠ WARNING** Risk of accident due to limited detectability of road users and traffic situations

Active Distance Assist DISTRONIC cannot always clearly identify other road users and complex traffic situations.

In these conditions, Active Distance Assist DISTRONIC may:

- Give an unnecessary warning and then brake the vehicle.
  - Neither give a warning nor intervene.
  - Accelerate or brake unexpectedly.
- ▶ Continue driving with care and be ready to brake, particularly if Active Distance Assist DISTRONIC warns you.

**⚠ WARNING** Risk of accident from acceleration or braking by Active Distance Assist DISTRONIC

Active Distance Assist DISTRONIC may accelerate or brake in the following cases, for example:

- If the vehicle pulls away using Active Distance Assist DISTRONIC.
- If the stored speed is called up and is considerably faster or slower than the currently driven speed.

- If Active Distance Assist DISTRONIC no longer detects a vehicle in front or does not react to relevant objects.

- ▶ Always carefully observe the traffic conditions and be ready to brake at all times.
- ▶ Take into account the traffic situation before calling up the stored speed.

**⚠ WARNING** Risk of accident due to insufficient deceleration by Active Distance Assist DISTRONIC

Active Distance Assist DISTRONIC brakes your vehicle with up to 50 % of the maximum possible deceleration. If this deceleration is not sufficient, Active Distance Assist DISTRONIC alerts you with a visual and acoustic warning.

- ▶ In these cases, adjust your speed and keep a sufficient distance.
- ▶ Brake the vehicle yourself and/or take evasive action.

**⚠ WARNING** Risk of accident due to Active Distance Assist DISTRONIC still being activated when you leave the driver's seat

If you leave the driver's seat while the vehicle is being braked by Active Distance Assist DISTRONIC only, the vehicle can roll away.

- ▶ Always deactivate Active Distance Assist DISTRONIC and secure the vehicle to prevent it from rolling away before you leave the driver's seat.

#### Requirements

- The vehicle's engine must be switched on.
- The electric parking brake must be released.
- Active Parking Assist is not being used to park the vehicle or to exit from a parking space.
- ESP® must be activated, but not intervening.
- The transmission must be in position **D**.
- The driver door, front passenger door and the rear doors must be closed.
- The engine hood must be closed.

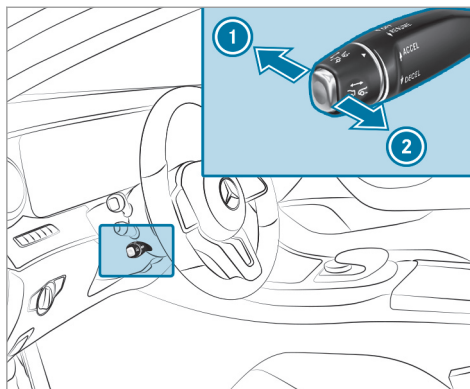

- ▶ Remove your foot from the accelerator pedal.
  - ▶ To store current speed **2**. Your vehicle adapts its speed to that of the vehicle in front, but only up to the stored speed.
- or
- ▶ Call up stored speed **2**.

- ▶ Or on vehicles with Driving Assistance Package and Traffic Sign Assist: the displayed speed limit is adopted, if available **2**.
- ▶ Deactivate Active Distance Assist DISTRONIC **1**.

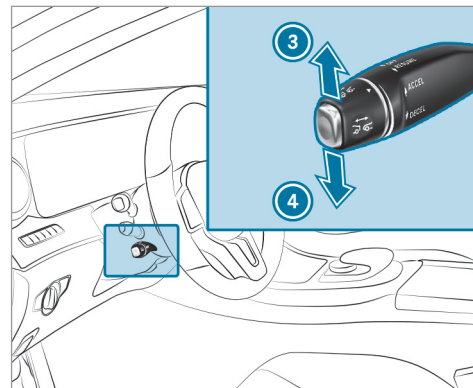

- ▶ Increase **3** or reduce **4** the speed.



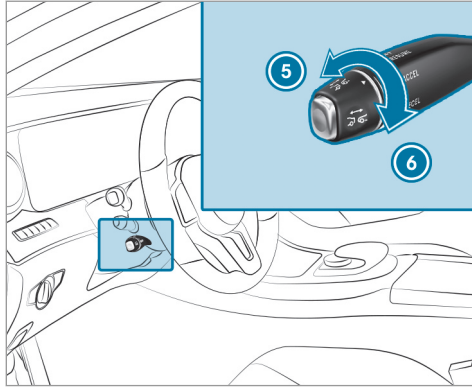

- ▶ Reduce ⑤ or increase ⑥ the specified distance from the vehicle in front.

#### **Pulling away with Active Distance Assist DISTRONIC**

**Requirement:** a speed must have been previously stored.

- ▶ Remove your foot from the brake pedal.

- ▶ Briefly pull the cruise control lever towards you ②.

or

- ▶ Accelerate briefly. Your vehicle pulls away and adapts its speed to that of the vehicle in front. If no vehicle is detected in front, your vehicle accelerates to the set speed.

#### **Adopting the speed limit as the stored speed Requirements:**

- Active Speed Limit Assist is activated in the multimedia system (→ page 192).
  - Active Distance Assist DISTRONIC is activated.
  - The system detects a traffic sign indicating a speed limit.
- ▶ Briefly pull the cruise control lever towards you ②. The displayed speed limit is adopted as the stored speed. Your vehicle adapts its speed to that of the vehicle in front, but only up to the stored speed. If Active Speed Limit Assist

is activated, any detected changes in the speed limit are adopted by the system.

#### **Collision warning**

If Active Distance Assist DISTRONIC is unable to sufficiently decelerate the vehicle in order to prevent it from approaching the vehicle in front, you will be warned visually and acoustically. An intermittent warning tone will then sound and the distance warning lamp will light up in the instrument cluster.

- ▶ Brake immediately in order to increase the distance from the vehicle in front.

or

- ▶ Take evasive action provided it is safe to do so.

#### **Active Steering Assist**

##### **Function of Active Steering Assist**

**Active Steering Assist is only available for vehicles with the Driving Assistance Package.**

- Active Steering Assist is operational at speeds up to 130 mph (210 km/h) and helps



you to stay in the center of the lane by means of moderate steering interventions.

- It uses the vehicle in front and the lane markings as a reference depending on the driven speed.
- Active Steering Assist requires you, as the driver, to keep your hands on the steering wheel at all times so that you are able to intervene at any time to correct the course of the vehicle and keep it in lane.
- Active Steering Assist can be overridden at any time by steering the vehicle yourself.
- When the system is actively steering, the  symbol is shown in green in the multifunction display.

#### System limitations of Active Steering Assist

Active Steering Assist has a limited steering torque for lateral guidance. In some cases, the steering intervention is not sufficient to keep the vehicle in the lane.

If the detection of lane markings and vehicles ahead is impaired, Active Steering Assist switches to passive mode. The system provides no support in this case. During the transition

from the active to passive status, the  symbol is shown as enlarged and flashes yellow. Once the system is passive the  symbol is grayed out in the multifunction display.

The system may be impaired or may not function in the following instances:

- If there is poor visibility, e.g. due to insufficient illumination of the road, or due to snow, rain, fog or heavy spray.
- If there is glare, e.g. from oncoming traffic, direct sunlight or reflection from other vehicles (e.g. if the carriageway is wet).
- If the windshield is dirty, fogged up, damaged or covered, for instance by a sticker, in the vicinity of the camera.
- If no, or several, unclear lane markings are present for one lane, e.g. in a construction area.
- If the lane markings are worn away, dark or covered up, e.g. by dirt or snow.
- The distance to the vehicle in front is too small and the lane markings thus cannot be detected.

- If the lane markings change quickly, e.g. lanes branch off, cross one another or merge.
- The carriageway is narrow and winding.
- If there are highly variable shade conditions on the carriageway.
- If there are obstacles such as object markers on the lane or projecting out into the lane.

The system does not provide assistance in the following conditions:

- On very sharp bends.
- When towing a trailer.
- If you actively change lane without switching on the turn signal indicator.
- If you switch on the turn signal indicator and the conditions for activating Active Lane Change Assist are not fulfilled.

#### Activating Active Steering Assist

##### Requirements:

- ESP<sup>®</sup> must be activated, but not intervening.

- Active Distance Assist DISTRONIC is activated.

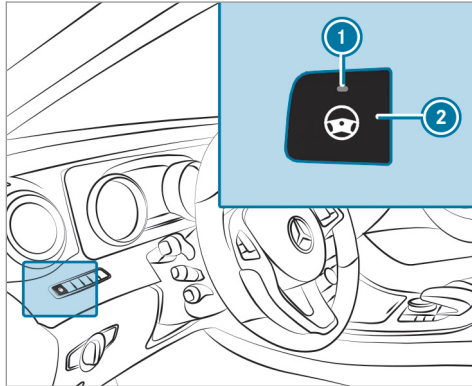

- If indicator lamp ① is off: press button ②.

### Function of Active Lane Change Assist

Active Steering Assist is only an aid. You are responsible for the distance to the vehicle in front, for vehicle speed, for braking in good time and for staying in your lane. Before changing

lanes, make sure that the neighboring lane is free (shoulder view).

- ① The availability of the following function is country-dependent.

Active Steering Assist remains active even if the turn signal indicator is switched on. Active Steering Assist then assists the driver when changing lanes by applying steering torques to initiate the lane change.

Assistance when changing lanes is provided if all the following conditions are met:

- You are driving on a motorway or high-speed multi-lane major road with multiple lanes in the direction of travel.
- The neighboring lane is free and separated by a broken lane marking.
- The driven speed is between 50 mph (80 km/h) and 110 mph (180 km/h).
- The turn signal indicator is switched on for longer than two seconds.

If the system is impaired, Active Lane Change Assist may be canceled. If an interruption occurs, display ① appears in the multifunction

display along with a warning tone prompting you to take control of the vehicle.



### Steering and contact detection

Active Steering Assist requires you as the driver, to keep your hands on the steering wheel at all times so that you are able to intervene at any time to correct the course of the vehicle and keep it in lane. The driver must expect a change from active to passive mode or vice versa at any time.

If you are not steering yourself or if you take your hands off the steering wheel for a prolonged period of time, the system will, depending on the situation, first alert you with a visual

warning.  appears in the multifunction display. If you are still not steering the vehicle yourself or if you have not taken hold of the steering wheel, a warning tone sounds in addition to the warning message to remind you to take control of the vehicle.

The warning message does not appear or disappears if one of the following conditions are met:

- The driver steers the vehicle.
- The driver presses a steering wheel button or operates Touch Control.

#### Function of Active Emergency Stop Assist

If the driver continues to ignore the acoustic warning of Active Lane Change Assist, Active Distance Assist DISTRONIC reduces the speed. If the driver still does not respond, the vehicle is decelerated in stages to a standstill.

The driver can cancel the deceleration at any time by performing one of the following actions:

- Steering
- Braking or accelerating
- Pressing a steering wheel button or operating Touch Control

- Activating or deactivating Active Steering Assist or Distance Assist DISTRONIC

The driver must be ready to take control of the vehicle at any time.

#### Information on Hill Start Assist

Hill Start Assist holds the vehicle for a short time when pulling away on a hill under the following conditions:

- The transmission is in position **D** or **R**.
- The electric parking brake is released.

This gives you enough time to move your foot from the brake pedal to the accelerator pedal and depress it before the vehicle begins to roll.

 **WARNING** Risk of accident and injury caused by the vehicle rolling away

After a short time, Hill Start Assist no longer holds the vehicle and it can roll away.

 Therefore, swiftly move your foot from the brake pedal to the accelerator

pedal. Never attempt to leave the vehicle if it is being held by Hill Start Assist.

#### HOLD function

##### HOLD function

The HOLD function holds the vehicle at a standstill without requiring you to depress the brake pedal, e.g. when pulling away on steep slopes.

##### System limitations

- The incline must not be greater than 30%.

##### Activating/deactivating the HOLD function

 **WARNING** Risk of an accident due to the HOLD function being activated when you leave the vehicle

If you leave the vehicle while only the HOLD function is braking the vehicle, the vehicle can roll away in the following situations:

- If there is a malfunction in the system or in the power supply.

- If the HOLD function is deactivated by depressing the accelerator pedal or the brake pedal, e.g. by a vehicle occupant.
- If the electrics in the engine compartment, the battery or the fuses are tampered with or if the battery is disconnected.

▶ Always deactivate the HOLD function and secure the vehicle against rolling away before leaving the vehicle.

#### **!** NOTE Damage from automatic braking

When Active Brake Assist, Active Distance Assist DISTRONIC or the HOLD function are activated, the vehicle brakes autonomously in certain situations.

To avoid damage to the vehicle, deactivate these systems in the following or similar situations:

- ▶ During towing
- ▶ In a car wash

#### Requirements:

- The vehicle is stationary.
- The driver's door is closed or the seat belt on the driver's side is fastened.
- The engine is running or has been automatically switched off by the ECO start/stop function.
- The electric parking brake is released.
- Active Distance Assist DISTRONIC is not activated.
- The transmission is in position **D**, **R** or **N**.

#### Activating the HOLD function

- ▶ Depress the brake pedal and after a short time depress further until the **HOLD** display appears in the multifunction display.
- ▶ Release the brake pedal.

#### Deactivating the HOLD function

- ▶ Depress the accelerator pedal to pull away.  
or
- ▶ Depress the brake pedal until the **HOLD** display disappears from the multifunction display.

The HOLD function is deactivated in the following situations:

- When Active Distance Assist DISTRONIC is activated.
- The transmission is switched to position **P**.
- When the vehicle is secured with the electric parking brake.

In the following situations, the vehicle is held by the transmission position **P** or by the electric parking brake:

- When the seat belt is unfastened and the driver's door is opened.
- When the engine is switched off.
- When there is a malfunction in the system or if the power supply is insufficient.

#### AIR BODY CONTROL

##### AIR BODY CONTROL function

AIR BODY CONTROL is an air suspension system with variable damping for improved driving comfort. The all-round level control system ensures the best possible suspension and constant

## 172 Driving and parking

---

ground clearance, even with a laden vehicle. When driving at speed, the vehicle is lowered automatically to improve driving safety and to reduce fuel consumption. The option of manually adjusting the vehicle level is also available.

AIR BODY CONTROL comprises:

- Air suspension with variable spring rate
- Automatic level control system
- Speed-dependent lowering to reduce fuel consumption
- Manually selectable high-level setting for greater ground clearance
- ADS PLUS (Adaptive Damping System with constant damping force adjustment)
- DYNAMIC SELECT switch and level button

### Available suspension settings

Drive program	Characteristics
<b>C</b> (Comfort)	<ul style="list-style-type: none"><li>• The suspension tuning is comfortable.</li><li>• The vehicle is set to the normal level.</li><li>• When driving at speeds of above 77 mph (125 km/h) the vehicle is lowered.</li><li>• When driving at speeds below 50 mph (80 km/h), the vehicle is raised again.</li></ul>
<b>E</b> (Economy)	<ul style="list-style-type: none"><li>• The suspension tuning is comfortable.</li><li>• The vehicle is set to the low level.</li><li>• The vehicle is not lowered any further if you are traveling at higher speeds.</li></ul>

Drive program	Characteristics
<b>S</b> (Sport)	<ul style="list-style-type: none"> <li>• The suspension tuning is firmer.</li> <li>• The vehicle is set to the low level.</li> <li>• The vehicle is not lowered any further if you are traveling at higher speeds.</li> </ul>
<b>S+</b> (Sport Plus)	<ul style="list-style-type: none"> <li>• The suspension tuning is even firmer.</li> <li>• The vehicle is set to the low level.</li> <li>• The vehicle is not lowered any further if you are traveling at higher speeds.</li> </ul>

### Setting the vehicle level

**⚠ WARNING** Risk of accident because vehicle level is too high

If you drive at a higher vehicle level, the driving characteristics may be impaired due to the higher vehicle center of gravity.

The vehicle can drift outwards, for example, when steering or cornering.

- ▶ Always choose a vehicle level which is suited to the driving style and the road surface conditions.

**⚠ WARNING** Risk of entrapment from vehicle lowering

When lowering the vehicle, people could become trapped if their limbs are between the vehicle body and the tires or underneath the vehicle.

- ▶ Make sure no one is underneath the vehicle or in the immediate vicinity of the wheel arches when you lower the vehicle.

**⚠ WARNING** Risk of entrapment from vehicle lowering

**Vehicles with AIR BODY CONTROL or level control system:** When you unload luggage or leave the vehicle, the vehicle first rises slightly and then returns to the set level shortly afterwards.

You or anyone else in the vicinity of the wheel arches or the underbody could thus become trapped.

The vehicle can also be lowered after being locked.

- ▶ When leaving the vehicle, make sure that nobody is in the vicinity of the wheel arches or the underbody.

### Requirements

- The vehicle has been started.
- The vehicle must not be moving faster than 37 mph (60 km/h).

### Raising the vehicle

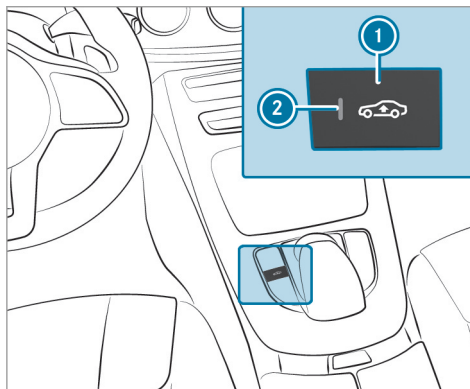

- ▶ Press button ①.  
Indicator lamp ② lights up.  
The vehicle is set to the high level.

Your selection is saved.

The vehicle is lowered again in the following situations:

- When driving faster than 50 mph (80 km/h).
- When driving between 37 mph (60 km/h) and 50 mph (80 km/h) for approximately three minutes.
- After selecting a drive program using the DYNAMIC SELECT switch.

The vehicle is adjusted to the height of the last active drive program.

### Lowering the vehicle

- ▶ Press button ①.  
Indicator lamp ② goes out. The vehicle is adjusted to the height of the active drive program.



## Parking Assist PARKTRONIC

### Function of Parking Assist PARKTRONIC

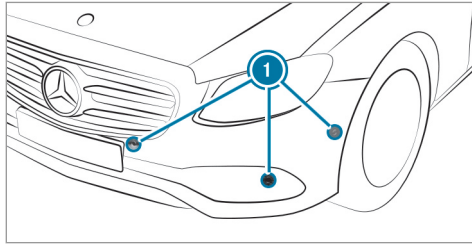

Parking Assist PARKTRONIC is an electronic parking assistance system with ultrasound. It monitors the area around your vehicle using six sensors ① in the front bumper and six sensors in the rear bumper. Parking Assist PARKTRONIC indicates visually and audibly the distance between your vehicle and an object.

Parking Assist PARKTRONIC is only an aid. It is not a substitute for paying attention to your surroundings. You are always responsible for safe maneuvering, parking and exiting a parking space. Make sure that there are no persons, ani-

mals or objects in the maneuvering area while maneuvering and parking in/exiting parking spaces.

In the standard setting, an intermittent warning tone sounds from a distance of approximately 1.0 ft (0.3 m) to an obstacle. A continuous tone sounds from a distance of approximately 0.7 ft (0.2 m). You can set the warning tone in the multimedia system so that it will sound earlier at a greater distance of approximately 3.3 ft (1.0 m) (→ page 178).

If Parking Assist PARKTRONIC is deactivated, Active Parking Assist is unavailable.

### Parking Assist PARKTRONIC display in the multimedia system

If Active Parking Assist is not activated and an obstacle is detected in the path of the vehicle, a pop-up window for Parking Assist PARKTRONIC ① appears in the multimedia system at speeds up to approximately 6 mph (10 km/h).



Vehicles with Active Parking Assist and a 360° Camera

### System limitations

Parking Assist PARKTRONIC does not necessarily take into account the following obstacles:

- Obstacles below the detection range, e.g. persons, animals or objects.
- Obstacles above the detection range, e.g. overhanging loads, overhangs or loading ramps of trucks.

The sensors must be free of dirt, ice and slush. Otherwise, they may not function correctly.

Clean the sensors regularly, taking care not to scratch or damage them.

### Function of the passive side impact protection

Passive side impact protection is an additional Parking Assist PARKTRONIC function which warns the driver about obstacles at the side of the vehicle. A warning is issued when obstacles are detected between the front and rear detection range. In order for an object to be detected, the sensors in the front and rear bumper must detect the object while you are driving past it.

During the parking procedure or maneuvering, objects are detected as the vehicle drives past. If you steer in the direction of a detected obstacle and there is a risk of a lateral collision, a warning is issued. The lateral segments light up orange or red, depending on the distance to the obstacle.

### Segment color depending on distance

Color	Lateral distance in cm
Red	Approx. < 30
Orange	Approx. 30 - 60

In order for lateral front or rear segments to be displayed, the vehicle must first travel a distance of at least half of the vehicle length. Once the vehicle has traveled the length of the vehicle, all of the lateral front and rear segments can be displayed.

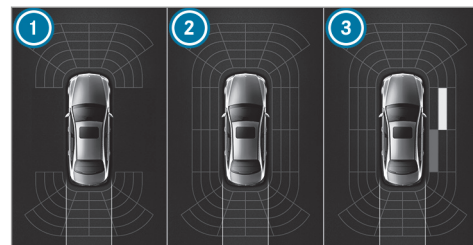

Vehicles without 360° Camera

- ① Parking Assist PARKTRONIC is only operational in the front and rear
- ② Parking Assist PARKTRONIC is operational and can also warn the driver about obstacles at the side of the vehicle
- ③ Obstacle detected at the front right (orange) and rear (red)

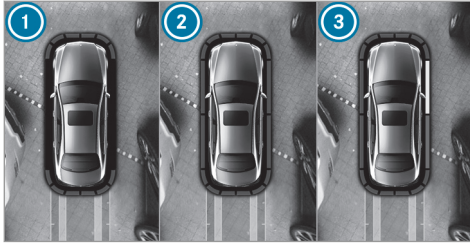

Vehicles with 360° Camera

- ① Parking Assist PARKTRONIC is only operational in the front and rear
- ② Parking Assist PARKTRONIC is operational and can also warn the driver about obstacles at the side of the vehicle
- ③ Obstacle detected at the front right (orange) and rear (red)

Saved obstacles are deleted in the following situations, for example:

- You switch off the vehicle
- You open the doors

After the engine is restarted, obstacles must be detected again, before a new warning can be issued.

### System limitations

The system limitations for Parking Assist PARKTRONIC apply for passive side impact protection.

The following objects are not detected, for example:

- Pedestrians who approach the vehicle from the side
- Objects placed next to the vehicle

### Deactivating/activating PARKTRONIC

- ❗ **NOTE** Risk of an accident from objects at close range

Parking Assist PARKTRONIC may not detect certain objects at close range.

- ▶ When parking or maneuvering the vehicle, pay particular attention to any objects which are above or below the sensors, e.g. flower pots or drawbars.

The vehicle or other objects could otherwise be damaged.

If indicator lamp ① is not lit, Parking Assist PARKTRONIC is active. If the indicator lamp is lit or the  symbol appears in the multifunction display, Parking Assist PARKTRONIC is not active.

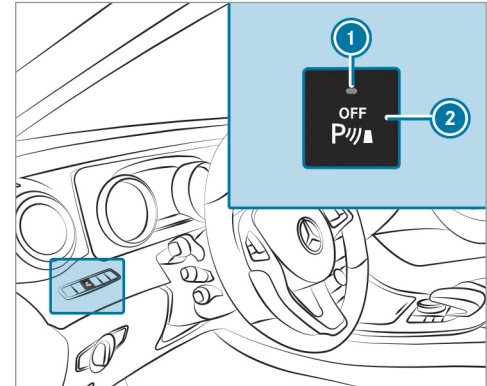

- ▶ Press button ②.

- ① Depending on the vehicle's equipment, the button may also be located in the center console.
- ① Parking Assist PARKTRONIC is automatically activated when the vehicle is started.

### Adjusting the warning tones of Parking Assist PARKTRONIC

Multimedia system:

→ Vehicle → Assistance → Camera & Parking → Set Warning Tones

### Adjusting the volume of the warning tones

- ▶ Select **Warning Tone Volume**.
- ▶ Set a value.

### Adjusting the pitch of the warning tones

- ▶ Select **Warning Tone Pitch**.
- ▶ Set a value.

### Specifying the starting point for the warning tones

You can specify whether the Parking Assist PARKTRONIC warning tones should commence when the vehicle is further away from an obstacle.

- ▶ Select **Warn Early**.
- ▶ Activate  or deactivate  the function.

### Activating/deactivating audio fadeout

You can specify whether the volume of a media source in the multimedia system is to be reduced when Parking Assist PARKTRONIC gives an audible warning.

- ▶ Select **Audio Fadeout During Warning Tones**.
- ▶ Activate  or deactivate  the function.

## Reversing camera

### Function of the rear view camera

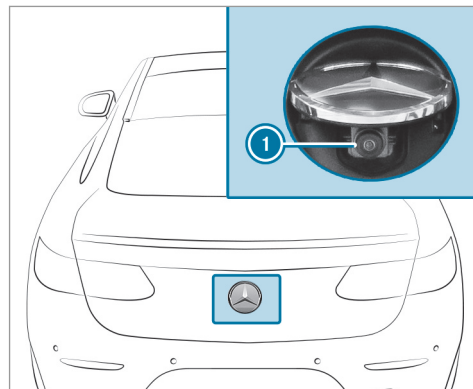

When you engage reverse gear, the image from rear view camera ① is shown in the multimedia system. Dynamic guide lines show the path the vehicle will take with the steering wheel in its current position. This helps you to orient yourself and to avoid obstacles when backing up.

The rear view camera is only an aid. It is not a substitute for your attention to the surroundings. The responsibility for safe maneuvering and parking remains with you. Make sure that there are no persons, animals or objects in the maneuvering area while maneuvering and parking in parking spaces.

You can select from the following views:

- Normal view
- Wide-angle view
- Trailer view

The area behind the vehicle is displayed as a mirror image, as in the inside rearview mirror.

### System limitations

The rear view camera will not function or will only partially function in the following situations:

- If the trunk lid or tailgate is open.
- There is heavy rain, snow or fog.
- The light conditions are poor, e.g. at night.
- The camera lens is obstructed, dirty or fogged up. Observe the notes on cleaning the rear view camera (→ page 327).

- The camera or rear of your vehicle is damaged. In this case, have the camera and its position and setting checked at a qualified specialist workshop.

The field of vision and other functions of the rear view camera may be restricted due to additional accessories on the rear of the vehicle (e.g. license plate bracket or bicycle rack).

- ① The display contrast may be impaired due to incident sunlight or other light sources. In this case, pay particular attention.
- ① If the display operation is considerably impaired due to pixel errors, for example, have the display repaired or replaced.

### Vehicles without Active Parking Assist

The following camera views are available in the multimedia system:

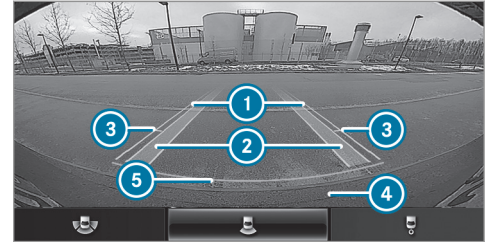

Normal view

- ① Yellow guide line, vehicle width (driven surface) depending on the current steering wheel angle (dynamic)
- ② Yellow lane marking the course the tires will take at the current steering wheel angle (dynamic)
- ③ Yellow guide line at a distance of approximately 3.3 ft (1.0 m) from the rear area
- ④ Bumper
- ⑤ Red guide line at a distance of approximately 12 in (0.3 m) from the rear area

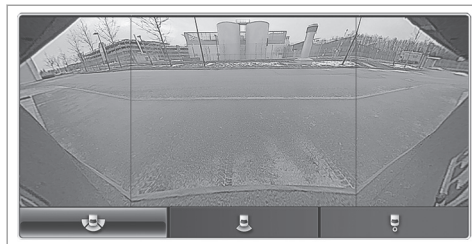

Wide-angle view

### Vehicles with Active Parking Assist

The following camera views are available in the multimedia system:

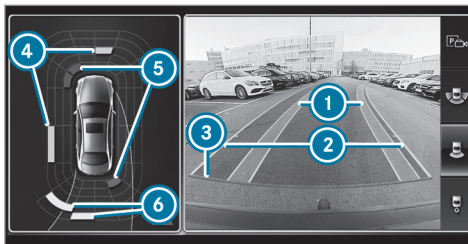

Normal view

- ① Yellow lane marking the course the tires will take at the current steering wheel angle (dynamic)
- ② Yellow guide line, vehicle width (driven surface) depending on the current steering wheel angle (dynamic)
- ③ Red guide line at a distance of approximately 12 in (0.3 m) from the rear area
- ④ Yellow warning display of Parking Assist PARKTRONIC: obstacles are at a distance of between approximately 2.0 ft (0.6 m) and 3.3 ft (1.0 m)

- ⑤ Red warning display of Parking Assist PARKTRONIC: obstacles are very close (approximately 1.0 ft (0.3 m) or less)
  - ⑥ Orange warning display of Parking Assist PARKTRONIC: obstacles are a medium distance away (between approximately 1.0 ft (0.3 m) and 2.0 ft (0.6 m))
- ⓘ If the entire system fails, the inner segments of the warning display are shown in red. The indicator lamp on the PARKTRONIC button lights up and the  symbol appears in the multifunction display.
- If the system fails in the rear:
- The rear segments are shown in red when backing up.
  - The rear segments are hidden when driving forwards.

When Active Parking Assist is active, the lanes are displayed in green. If Parking Assist PARKTRONIC is deactivated, the warning display fades out.



Wide-angle view

### 360° camera

#### Function of the 360° Camera

The 360° Camera is a system that consists of four cameras. The cameras cover the immediate vehicle surroundings. The system supports you, e.g. when parking or at exits with reduced visibility.

The 360° Camera is only an aid. It is not a substitute for your attention to the surroundings. The responsibility for safe maneuvering and parking remains with you. Make sure that there are no persons, animals or objects in the maneu-

vering area while maneuvering and parking in parking spaces.

The system evaluates images from the following cameras:

- Rear view camera
- Front camera
- Two side cameras in the outside mirrors

#### Views of the 360° Camera

You can select from different views:



- 1 Wide-angle view, front
- 2 Top view with image from the front camera

- 3 Top view with images from the side cameras in the outside mirrors
- 4 Wide-angle view, rear
- 5 Top view with image from the rear view camera
- 6 Top view with trailer view (if trailer hitch is fitted)

### Top view

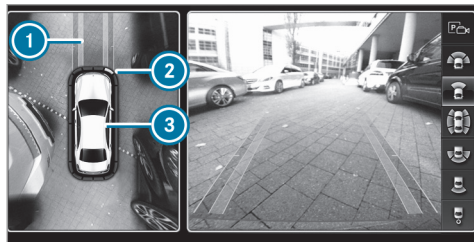

- ① Lane indicating the route the vehicle will take with the steering wheel in its current position
- ② Yellow warning display of Parking Assist PARKTRONIC: obstacles at a distance of approximately 3.3 ft (1.0 m) or less
- ③ Your vehicle from above

If the distance to the object lessens, the color of the warning display changes ②. From a distance of approximately 2.0 ft (0.6 m) the warning display is shown in orange. From a distance of approximately 1.0 ft (0.3 m) the warning display is shown in red.

When Parking Assist PARKTRONIC is operational and no object is detected, the segments of the warning display are shown in gray.

- ⓘ If the entire system fails, the segments of the warning display are shown in red. The indicator lamp on the PARKTRONIC button lights up and the  symbol appears in the multifunction display.

If the system fails at the rear, the display of the segments changes as follows:

- The rear segments are shown in red when backing up.
- The rear segments are hidden when driving forwards.

If Parking Assist PARKTRONIC is deactivated, the warning display fades out.

### Guide lines

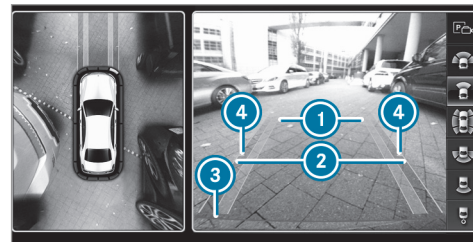

- ① Yellow lane marking the course the tires will take at the current steering wheel angle (dynamic)
  - ② Yellow guide line, vehicle width (driven surface) depending on the current steering wheel angle (dynamic)
  - ③ Red guide line at a distance of approximately 12 in (0.3 m) from the rear area
  - ④ Mark at a distance of approx. 3.3 ft (1.0 m)
- ⓘ When Active Parking Assist is active, the lanes are displayed in green.



The guide lines in the multimedia system display show the distances to your vehicle. The distances only apply to road level.

### Side view of the mirror cameras

The sides of the vehicle can be seen in this view.

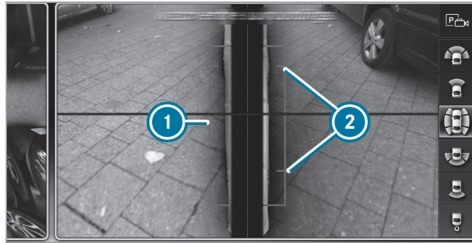

- ① Guide line of external vehicle dimensions with outside mirrors folded out
- ② Marker of the wheel contact points

### System limitations

The 360° Camera will not function or will only partially function in the following situations:

- If the doors are open.

- The side mirrors are folded in.
- If the trunk lid or tailgate is open.
- There is heavy rain, snow or fog.
- The light conditions are poor, e.g. at night.
- The camera lens is obstructed, dirty or fogged up.
- Cameras, or vehicle components in which the cameras are installed, are damaged. In this event, have the cameras, their positions and their setting checked at a qualified specialist workshop.

Do not use the 360° Camera under such circumstances. You could otherwise injure others or collide with objects when parking the vehicle.

On vehicles with height-adjustable suspension or if the vehicle is carrying a heavy load, leaving the standard height can result in inaccuracies in the guide lines and in the display of the generated images, depending on technical conditions.

The field of vision and other functions of the camera system may be restricted due to additional accessories on the rear of the vehicle (e.g. license plate bracket, bicycle rack).

See the notes on cleaning the 360° Camera (→ page 327).

### Selecting a view for the 360° Camera

#### Requirements

- The **Auto. Rear View Cam.** function is selected in the multimedia system.
- ▶ Engage reverse gear.
  - ▶ In the multimedia system, select the desired view.

### Opening the camera cover of the reversing camera

Multimedia system:

↳ Vehicle ▶  Assistance ▶ Camera & Parking

▶ Select **Open Camera Cover.**

- ⓘ The camera cover closes automatically after some time or after an ignition cycle.

### Assigning the camera as a favorite

You can call up the camera view directly in the multimedia system by assigning it as a favorite.

- ▶ Press the  button on the touchpad or controller.  
The main functions are displayed.
- ▶ Navigate downwards twice.  
The Favorites menu appears.
- ▶ Select **New Favorite**.
- ▶ Select **Vehicle**.
- ▶ Select **Camera**.

## Active Parking Assist

### Function of Active Parking Assist

Active Parking Assist is an electronic parking assistance system which uses ultrasound and is automatically activated during forward travel. The system is operational at speeds of up to approximately 22 mph (35 km/h). When all the conditions are fulfilled, the  symbol appears in the multifunction display and the system automatically searches for and measures parking spaces on both sides of the vehicle parallel and perpendicular to the direction of travel. If Active Parking Assist is activated, suitable parking spaces are displayed in the multimedia system.

The  symbol appears in the multifunction display. The arrows show on which side of the carriageway free parking spaces are located.

The parking space and, if necessary, the parking direction can be selected as desired. Active Parking Assist calculates a suitable vehicle path and assists you in parking and exiting the parking space.

Active Parking Assist changes gear, accelerates, brakes and steers the vehicle.

Active Parking Assist is only an aid. It is not a substitute for your attention to the surroundings. The responsibility for safe maneuvering and parking remains with you. Make sure that no persons, animals or objects etc. are in the maneuvering range.

Active Parking Assist is canceled if, among other things, one of the following actions is carried out:

- You deactivate Parking Assist PARKTRONIC.
- You deactivate Active Parking Assist.
- You begin steering.
- You apply the parking brake.

- You engage **P**.
- ESP® intervenes.
- You open the tailgate.

### System limitations of Active Parking Assist

Objects located above or below the detection range of Active Parking Assist are not detected when the parking space is being measured. These are also not taken into account when the parking maneuver is calculated, e.g. overhanging loads, overhangs or loading ramps of trucks or the boundaries of parking spaces. In some circumstances, Active Parking Assist may therefore guide you into the parking space prematurely.

 **WARNING** Risk of accident due to objects located above or below the detection range of Active Parking Assist

If there are objects above or below the detection range, the following situations may arise:

- Active Parking Assist may steer too early.

- **Vehicles with automatic transmission:** The vehicle may not stop in front of these objects.

This could cause a collision.

- ▶ In these situations, do not use Active Parking Assist.

Snowfall or heavy rain may lead to a parking space being measured inaccurately. Parking spaces that are partially occupied by trailer draw bars might not be identified as such or be measured incorrectly. Only use Active Parking Assist on level, high-grip ground.

Do not use Active Parking Assist in the following situations:

- If you are driving in extreme weather conditions such as ice, packed snow or in heavy rain.
- If you are transporting a load that protrudes beyond the vehicle.
- If the parking space is on a steep downhill or uphill gradient.
- If you have installed snow chains.

Active Parking Assist may also display parking spaces that are not suitable for parking, e.g.:

- Parking spaces where parking is prohibited.
- Parking spaces on unsuitable surfaces.

Active Parking Assist will not assist you with parking spaces at right angles to the direction of travel in the following situations:

- If two parking spaces are located immediately next to each other.
- If the parking space is directly next to a low obstacle such as a low curb.

Active Parking Assist will not assist you with parking spaces at right angles to the direction of travel in the following situations:

- If the parking space is on a curb.
- If the parking space is bordered by an obstacle, e.g. a tree, a post or a trailer.

#### Parking with Active Parking Assist

- ⓘ Depending on the vehicle's equipment, the button may also be located at a different position in the center console.

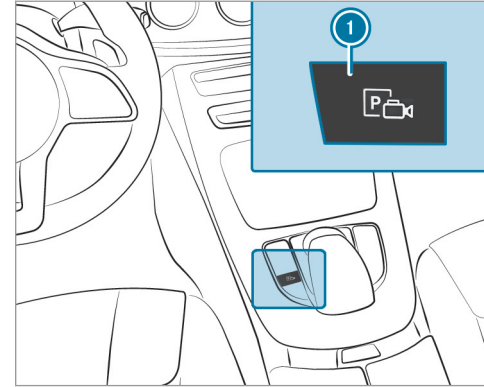

- ▶ Press button ①. The Active Parking Assist view appears on the multimedia system display. Area ② displays detected parking spaces ④ and vehicle path ③.

- ⓘ Vehicle path ③ shown on the multimedia system display may differ from the actual vehicle path.



- ▶ If you have driven past a suitable parking space: bring the vehicle to a standstill.
- ▶ Select desired parking space ④.
- ▶ Where necessary, select the parking direction: forwards or backwards. Vehicle path ③ is shown, depending on the selected parking space and parking direction.
- ▶ Confirm the selected parking space.

**⚠ WARNING** Risk of accident due to vehicle swinging out while parking or pulling out of a parking space

While parking or exiting a parking space, the vehicle swings out and can drive onto areas of the oncoming lane.

This could cause you to collide with objects or other road users.

- ▶ Pay attention to objects and other road users.
- ▶ Where necessary, stop the vehicle or cancel the parking procedure with Active Parking Assist.

- ▶ If, for example, the **Engage Reverse Gear** message appears in the multimedia system display: select the corresponding transmission position. The vehicle drives into the selected parking space.

On completion of the parking procedure, the **Parking Assist Finished, Take Control of Vehicle**

display message appears. Further maneuvering may still be necessary.

- ▶ After completion of the parking procedure, safeguard the vehicle against rolling away. When required by legal requirements or local conditions: turn the wheels towards the curb.
- ⓘ You can stop the vehicle and change the transmission position during the parking procedure. The system then calculates a new vehicle path. The parking procedure can then be continued. If no new vehicle path is available, the transmission position will be changed again. If the vehicle has not yet reached the parking space, the parking procedure will be canceled, should a gear be changed.

#### **Exiting a parking space with Active Parking Assist**

##### **Requirement**

You can only exit a parking space with Active Parking Assist if you have previously parked the vehicle with Active Parking Assist.

Please note that you are responsible for the vehicle and surroundings during the entire parking procedure.

- ▶ Start the vehicle.

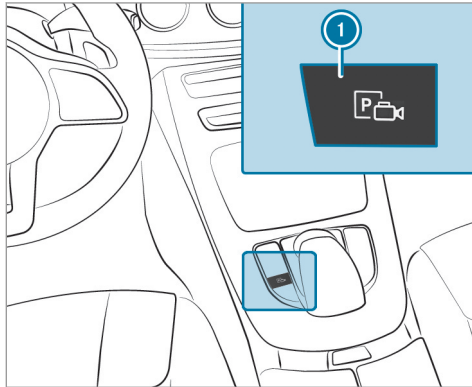

- ▶ Press button ❶.  
The Active Parking Assist view appears on the multimedia system display.

- ▶ If the vehicle has been parked at right angles to the direction of travel: in area ❷, select direction of travel ❸.



- ❶ The vehicle path shown on the multimedia system display may differ from the actual vehicle path.
- ▶ Confirm to start the exiting process.

**⚠ WARNING** Risk of accident due to vehicle swinging out while parking or pulling out of a parking space

While parking or exiting a parking space, the vehicle swings out and can drive onto areas of the oncoming lane.

This could cause you to collide with objects or other road users.

- ▶ Pay attention to objects and other road users.
- ▶ Where necessary, stop the vehicle or cancel the parking procedure with Active Parking Assist.

- ▶ If, for example, the **Engage Forward Gear** message appears in the multimedia system display: select the corresponding transmission position.  
The vehicle moves out of the parking space.

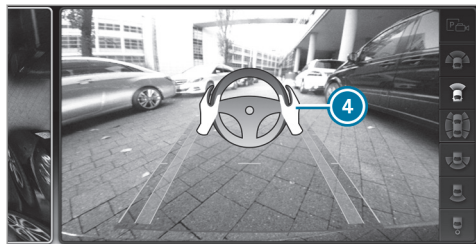

Example: vehicles with 360° Camera

After the exiting procedure has been completed, the **Parking Assist Finished, Take Control of Vehicle** message appears in the display of the multimedia system. A warning tone and display 4 in the multimedia system prompt you to take over control of the vehicle. You have to accelerate, brake, steer and change gear yourself again.

#### Function of Drive Away Assist

Drive Away Assist can reduce the severity of an impact when pulling away. If an obstacle is detected in the direction of travel, the vehicle's speed is briefly reduced to approx. 1 mph (2 km/h). If a critical situation is detected, a

symbol appears on the camera image of the multimedia system.

**⚠ WARNING** Risk of accident caused by limited detection performance of Drive Away Assist

Drive Away Assist cannot always clearly identify objects and traffic situations.

In such cases, Drive Away Assist might:

- Warn you without reason and limit the vehicle speed.
  - Not warn you or not limit the vehicle speed.
- ▶ Always pay careful attention to the traffic situation; do not rely on Drive Away Assist alone.
- ▶ Be prepared to brake or swerve as necessary, provided the traffic situation permits and that it is safe to take evasive action.

Drive Away Assist is only an aid. It is not a substitute for your attention to the surroundings.

The responsibility for safe maneuvering and parking remains with you. Make sure that no persons, animals or objects etc. are in the maneuvering range.

A risk of a collision may arise in the following situations, for example:

- If the driver mixes up the accelerator and brake pedals.
- If the wrong gear is selected.

The Drive Away Assist function is active under the following conditions:

- If Parking Assist PARKTRONIC is activated.
- Every time the gear is changed to **R** or **D** when the vehicle is at a standstill.
- If the detected obstacle is less than approx. 3.3 ft (1.0 m) away.
- If the maneuvering assistant function is activated in the multimedia system.

#### System limitations

Drive Away Assist is not available on inclines.

### Function of Cross Traffic Alert

**i** Also read the instructions on Blind Spot Assist (→ page 193).

**Vehicles with Blind Spot Assist:** Drivers can also be warned of any crossing traffic when backing out of a parking space. If a critical situation is detected, a warning symbol appears on the camera image of the multimedia system. If the driver does not respond to the warning, the vehicle's brakes can be applied automatically. To do this, the function uses the radar sensors in the bumper. The area adjacent to the vehicle is continually monitored.

If the radar sensors are obstructed by vehicles or other objects, detection is not possible.

The Cross Traffic Alert function is active under the following conditions:

- If Blind Spot Assist is activated.
- If the vehicle is backing up at walking pace.
- If the maneuvering assistant function is activated in the multimedia system.

The Cross Traffic Alert function is not available on inclines.

### Deactivating/activating the maneuvering assistant

Multimedia system:

→ **Vehicle** ▶ **Assistance** ▶ **Camera & Parking** ▶ **Maneuvering Assist**.

▶ Switch the function on  or off .

### ATTENTION ASSIST

#### Function of ATTENTION ASSIST

ATTENTION ASSIST assists you on long, monotonous journeys, e.g. on freeways and trunk roads. If ATTENTION ASSIST detects indicators of fatigue or increasing lapses in concentration on the part of the driver, it suggests taking a break.

ATTENTION ASSIST is only an aid. It cannot always detect fatigue or lapses in concentration until too late. The system is not a substitute for a well-rested and attentive driver. On long journeys, take regular breaks in good time that allow for adequate recuperation.

You can choose between two settings.

- **Standard:** normal system sensitivity

- **Sensitive:** higher system sensitivity. The driver is warned earlier and the attention level detected by ATTENTION ASSIST is adapted accordingly.

If drowsiness or increasing lapses in concentration are detected, the **ATTENTION ASSIST: Take a Break!** warning appears in the Instrument Display. You can acknowledge the message and take a break where necessary. If you do not take a break and ATTENTION ASSIST continues to detect increasing lapses in concentration, you will be warned again after a minimum of 15 minutes.



You can have the following status information for ATTENTION ASSIST displayed in the assistance menu of the on-board computer:

- The length of the journey since the last break.
- The attention level determined by ATTENTION ASSIST.

If ATTENTION ASSIST is unable to calculate the attention level and cannot issue a warning, the **System Suspended** message appears.

If a warning is given in the Instrument Display, the multimedia system offers to search for a rest area. You can select a rest area and start navigation to this rest area. This function can be activated and deactivated in the multimedia system.

If ATTENTION ASSIST is deactivated, the  symbol appears in the assistance graphic in the Instrument Display when the engine is running. ATTENTION ASSIST is activated automatically when the engine is re-started. The last selected sensitivity level remains stored.

### System limitations

ATTENTION ASSIST is active in the 37 mph (60 km/h) to 124 mph (200 km/h) speed range.

The functionality of ATTENTION ASSIST is restricted, and warnings may be delayed or not occur at all in the following situations:

- If you have been driving for less than 30 minutes.
- If the road condition is poor (uneven road surface or potholes).
- If there is a strong side wind.
- If you adopt a sporty driving style (high cornering speeds or high rates of acceleration).
- If the Steering Assist function of Distance Assist DISTRONIC is active.
- If the time has been set incorrectly.
- In active driving situations, if you change lanes and vary your speed frequently.

The ATTENTION ASSIST tiredness or alertness assessment is deleted and restarted when continuing the journey in the following situations:

- If you switch off the engine.

- If you unfasten your seat belt and open the driver's door (e.g. change drivers or take a break).

### Setting ATTENTION ASSIST

Multimedia system:

 Vehicle  Assistance  ATTENTION ASSIST

### Setting options

- ▶ Select **Standard**, **Sensitive** or **Off**.

### Suggesting a rest area

- ▶ Select **Suggest Rest Area**.
- ▶ Activate  or deactivate the function . If ATTENTION ASSIST detects fatigue or increasing lack of attention, it suggests a rest area in the vicinity.
- ▶ **Select a suggested rest area.** You are guided to the selected rest area.



## Traffic Sign Assist

### Function of Traffic Sign Assist

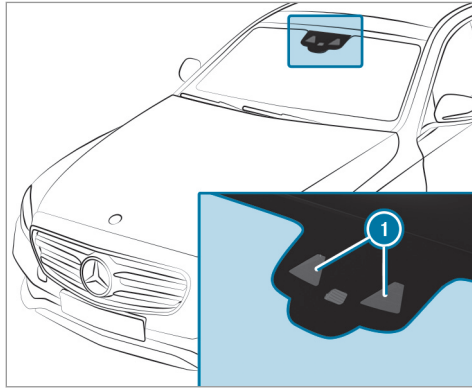

Traffic Sign Assist detects traffic signs using multifunction camera ①. It assists you by displaying detected speed limits and overtaking restrictions in the instrument cluster.

Since Traffic Sign Assist also uses the data stored in the navigation system, it can update the display in the following situations without detecting traffic signs:

- When the vehicle changes roads, e.g. slip road or motorway exit.
- When a village or town boundary is passed which is stored in the digital map.

The camera also detects traffic signs with a restriction indicated by an additional sign (e.g. relating to wet conditions).

### Warning when the maximum permissible speed is exceeded

The system can warn you if you unintentionally exceed the maximum permissible speed. To do this, you can specify in the multimedia system by how much the maximum permissible speed can be exceeded before a warning is issued. You can specify whether the warning is to be just a visual warning or an acoustic one as well.

### Display in the Instrument Display

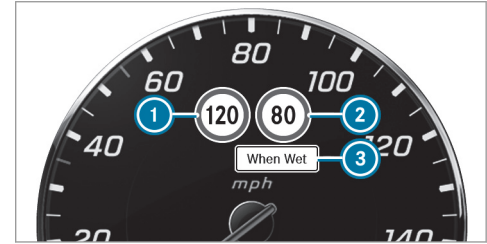

- ① Permissible speed
- ② Permissible speed when there is a restriction
- ③ Additional sign with restriction
- i The illustration shows the Instrument Display in the Widescreen Cockpit



Traffic Sign Assist is not available in all countries. If it is unavailable, display ① is shown in the speedometer.

### System limitations

The system may be impaired or may not function in the following situations:

- If there is poor visibility, e.g. due to insufficient illumination of the road, highly variable shade conditions, or due to rain, snow, fog or heavy spray.
- If there is glare, e.g. from oncoming traffic, direct sunlight or reflections.

- If there is dirt on the windshield in the vicinity of the multifunction camera or the camera is fogged up, damaged or obscured.
- If the traffic signs are hard to detect, e.g. due to dirt or snow, or because they are covered, or due to insufficient lighting.
- If the information in the navigation system's digital map is incorrect or out-of-date.
- If the signs are ambiguous, e.g. traffic signs on construction sites or in adjacent lanes.

### Setting Traffic Sign Assist

Multimedia system:

→ Vehicle →  Assistance → Traffic Sign Assist

### Activating /deactivating automatic adoption of speed limits

Requirements

- Active Distance Assist DISTRONIC is activated.
- ▶ Select [Limit Adoption](#).

- ▶ Activate  or deactivate  the function. The speed limits detected by Traffic Sign Assist are automatically adopted by Active Distance Assist DISTRONIC.

### Displaying detected traffic signs in the media display

- ▶ Select [Display in COMAND](#).
- ▶ Activate  or deactivate  the function.

### Adjusting the type of warning

- ▶ Select [Visual & Audible](#), [Visual](#) or [None](#).

### Adjusting the warning threshold

This value determines the speed at which a warning is issued when exceeded.

- ▶ Select [Warning Threshold](#).
- ▶ Set the desired speed.

## Blind Spot Assist and Active Blind Spot Assist

### Function of Blind Spot Assist and Active Blind Spot Assist

Blind Spot Assist uses two lateral, rear-facing radar sensors to monitor the area up to 130 ft (40 m) behind your vehicle and 10 ft (3 m) directly next to your vehicle.

If a vehicle is detected at speeds above approximately 8 mph (12 km/h) and this vehicle subsequently enters the monitoring range directly next to your vehicle, the warning lamp in the outside mirror lights up red.

If a vehicle is detected close to your vehicle in the lateral monitoring range and you switch on the turn signal indicator in the corresponding direction, a warning tone sounds once. The red warning lamp in the outside mirror flashes. If the turn signal indicator remains on, all other detected vehicles are indicated only by the flashing of the red warning lamp.

If you overtake a vehicle quickly, no warning is given.

### **▲ WARNING** Risk of accident despite Blind Spot Assist

Blind Spot Assist does not react to vehicles approaching and overtaking you at a greatly different speed.

As a result, Blind Spot Assist cannot warn drivers in this situation.

- ▶ Always pay careful attention to the traffic situation and maintain a safe distance at the side of the vehicle.

Blind Spot Assist and Active Blind Spot Assist are only aids. They may fail to detect some vehicles and are no substitute for attentive driving. Always ensure that there is sufficient distance to the side for other road users and obstacles.

### System limitations

The system may be limited in the following situations:

- the sensors are dirty or covered
- poor visibility, e.g. due to fog, heavy rain, snow or spray

- narrow vehicles, e.g. bicycles, are within the monitoring range

Warnings may be issued in error when driving close to crash barriers or similar solid lane borders. Warnings may be interrupted when driving alongside long vehicles, e.g. trucks, for a prolonged time.

Blind Spot Assist is not operational when reverse gear is engaged.

### Function of braking applications (Active Blind Spot Assist)

If Active Blind Spot Assist detects a risk of a side impact in the monitoring range, a course-correcting brake application is carried out. This is designed to help you avoid a collision.

The course-correcting brake application is available in the speed range between approximately 20 mph (30 km/h) and 125 mph (200 km/h).

**⚠ WARNING** Risk of accident despite brake application of Active Blind Spot Assist

A course-correcting brake application cannot always prevent a collision.

- ▶ Always steer, brake or accelerate yourself, especially if Active Blind Spot Assist warns you or makes a course-correcting brake application.
- ▶ Always maintain a safe distance at the sides.

**⚠ WARNING** Risk of accident despite Active Blind Spot Assist

Active Blind Spot Assist does not react to the following:

- Overtaking vehicles closely on the side, placing them in the blind spot area.
- Vehicles approaching and overtaking you at a very different speed.

As a result, Active Blind Spot Assist may neither give warnings nor intervene in such situations.

- ▶ Always pay careful attention to the traffic situation and maintain a safe distance at the side of the vehicle.



If a course-correcting brake application occurs, the red warning lamp flashes in the outside mirror and a warning tone sounds. In addition, display ① indicating the danger of a side collision appears in the multifunction display.

In rare cases, the system may make an inappropriate brake application. This brake application

may be interrupted at any time if you steer slightly in the opposite direction or accelerate.

### System limitations

Either a course-correcting brake application appropriate to the driving situation, or none at all, may occur in the following situations:

- Vehicles or obstacles, e.g. crash barriers, are located on both sides of your vehicle.
- A vehicle approaches too closely on the side.
- You have adopted a sporty driving style with high cornering speeds.
- You brake or accelerate significantly.
- A driving safety system intervenes, such as ESP® or Active Brake Assist.
- ESP® is deactivated.
- A loss of tire pressure or a defective tire is detected.

### Activating or deactivating Blind Spot Assist or Active Blind Spot Assist

Multimedia system:

Vehicle ► Assistance ► Blind Spot Assist

► Activate  or deactivate  the function.

### Active Lane Keeping Assist

#### Active Lane Keeping Assist function

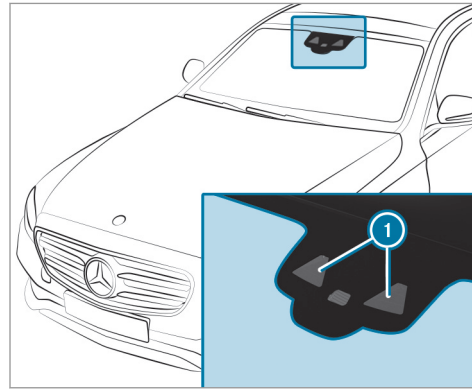

Active Lane Keeping Assist monitors the area in front of your vehicle by means of multifunction camera ①. It serves to protect you against unintentionally leaving your lane. You will be warned by means of a vibration in the steering wheel

and a course-correcting brake application guides you back into your lane.

You are warned by vibration pulses in the steering wheel in the following circumstances:

- Active Lane Keeping Assist detects lane markings.
- A front wheel passes over the lane markings.

You will also be guided back into your lane by means of a course-correcting brake application if the following conditions are met:

- Active Lane Keeping Assist detects lane markings.
- A front wheel drives over a solid lane marking.

Whether a warning is issued and when this occurs also depends on the selected sensitivity setting (standard or adaptive).

If you fail to adapt your driving style, Active Lane Keeping Assist can neither reduce the risk of an accident nor override the laws of physics. It cannot take into account road, weather or traffic conditions. Active Lane Keeping Assist is only an aid. You are responsible for the distance to the

vehicle in front, for vehicle speed, for braking in good time and for staying in lane.

**Vehicles with Lane Tracking package:** If the lane markings are solid lines and you do not react to the warning, a lane-correcting brake application can bring the vehicle back into the original lane.

**Vehicles with Driving Assistance package or Driving Assistance Plus package:** If you do not react to the warning, a lane-correcting brake application can bring the vehicle back into the original lane. In the case of a broken lane marking being detected, a brake application will only be made if a vehicle has been detected in the adjacent lane. Oncoming vehicles, overtaking vehicles and vehicles in adjacent lanes can be detected.

The brake application is available in the speed range between 40 mph (60 km/h) and 120 mph (200 km/h).

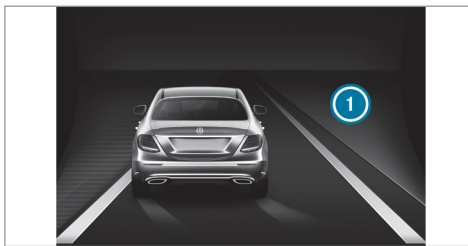

If a lane-correcting brake application occurs, display ① appears in the multifunction display.

#### System limitations

No lane-correcting brake application occurs in the following situations:

- You clearly and actively steer, brake or accelerate.
- You have switched on the turn signal indicator.
- A driving safety system intervenes, such as ESP®, Active Brake Assist or Active Blind Spot Assist.

- You have adopted a sporty driving style with high cornering speeds or high rates of acceleration.
- ESP® is deactivated.
- When driving with a trailer, the electrical connection to the trailer has been correctly established.
- If a loss of tire pressure or a defective tire has been detected and displayed.

The system may be impaired or may not function in the following situations:

- If there is poor visibility, e.g. due to insufficient illumination of the road, highly variable shade conditions, or due to rain, snow, fog or heavy spray.
- There is glare, e.g. from oncoming traffic, the sun or reflections.
- If there is dirt on the windshield in the vicinity of the multifunction camera or the camera is misted up, damaged or obscured.
- No or several, unclear lane markings are present for one lane, e.g. near roadworks.
- The lane markings are worn, dark or covered.

- The distance to the vehicle in front is too small and the lane markings thus cannot be detected.
- The lane markings change quickly, e.g. lanes branch off, cross one another or merge.
- The carriageway is very narrow and winding.

**Vehicles with Driving Assistance package or Driving Assistance Plus package:** Active Lane Keeping Assist uses radar sensors to monitor several areas around the vehicle. If the radar sensors in the rear bumper are dirty or covered with snow, the system may be impaired or may not function. If an obstacle in the lane in which you are driving has been detected, no lane-correcting brake application occurs.

#### Activating Active Lane Keeping Assist

**⚠ WARNING** Risk of accident despite Active Lane Keeping Assist warning

A lane-correcting brake application cannot always bring the vehicle back into the original lane.

- ▶ Always steer, brake or accelerate yourself, especially if Active Lane Keeping Assist warns you or makes a lane-correcting brake application.

**⚠ WARNING** Risk of accident despite intervention of Active Lane Keeping Assist

Active Lane Keeping Assist does not detect traffic conditions or road users. In very rare cases, the system may make an inappropriate brake application, e.g. after intentionally driving over a solid lane marking.

The brake application can be interrupted at any time if you steer slightly in the opposite direction.

- ▶ Always make sure that there is sufficient distance to the side for other traffic or obstacles.

**⚠ WARNING** Risk of accident despite Lane Keeping Assist

Lane Keeping Assist cannot always clearly detect lane markings.

In such cases, Lane Keeping Assist can:

- give an unnecessary warning
  - not give a warning
- ▶ Always pay particular attention to the traffic situation and keep within the lane, especially if Active Lane Keeping Assist alerts you.

#### Requirement

The driving speed is at least 40 mph (60 km/h).

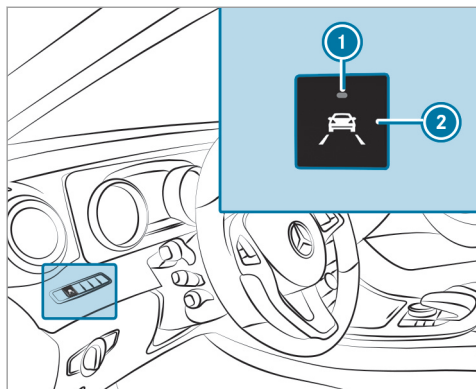

- ▶ Press button ②.
- If indicator lamp ① lights up, Lane Keeping Assist is activated. When lane markings are detected, the lines in the assistance graphic are shown in white.

### Sensitivity of Active Lane Keeping Assist

With the standard or adaptive setting, you can influence when the warning vibration of Lane Keeping Assist takes place.

In both the standard and adaptive settings, no warning vibration occurs in the following situations:

- You have switched on the turn signal indicator.
- A driving safety system intervenes, such as ABS, BAS or ESP®.

In the adaptive setting, there will also be no warning vibration in the following situations:

- The vehicle is accelerated or braked considerably.
- You steer actively, e.g. swerve to avoid an obstacle or change lane quickly.
- You cut the corner on a sharp bend.

### Setting the sensitivity of Active Lane Keeping Assist

Multimedia system:

↳ Vehicle ▶  Assistance ▶▶ Act.

Lane Keep. Assist

- ▶ Select a setting.



## Instrument Display overview

**⚠ WARNING** Risk of accident due to an instrument display malfunction

If the instrument display has failed or malfunctioned, you cannot recognize function restrictions applying to safety relevant systems.

The operating safety of your vehicle may be impaired.

- ▶ Drive on carefully.
- ▶ Have the vehicle checked immediately at a qualified specialist workshop.

If the operating safety of your vehicle is impaired, park the vehicle safely as soon as possible. Contact a qualified specialist workshop.

## Instrument Display (standard)

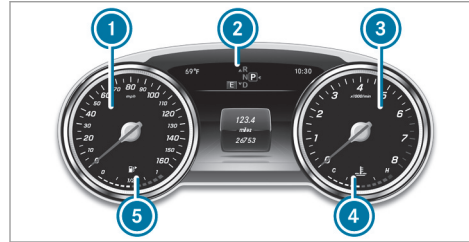

- ① Speedometer
- ② Multifunction display
- ③ Tachometer
- ④ Coolant temperature display
- ⑤ Fuel level and fuel filler flap location indicator

## Instrument Display in the Widescreen Cockpit

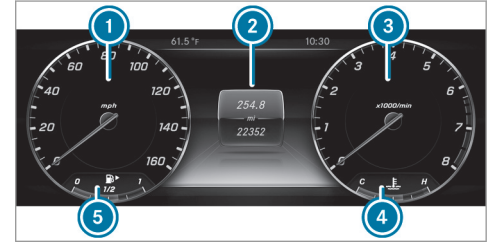

- ① Speedometer
- ② Multifunction display
- ③ Example: area for additional values
- ④ Coolant temperature display
- ⑤ Fuel level and fuel filler flap location indicator

① Further display content can be shown in display ③ for additional values (→ page 202).

The segments in speedometer ① indicate the system status for the following:

- Cruise control (→ page 160)

- Active Distance Assist DISTRONIC  
(→ page 162)

**NOTE** Engine damage due to excessively high engine speeds

The engine will be damaged if you drive with the engine in the overrevving range.

- ▶ Do not drive with the engine in the overrevving range.

The fuel supply is interrupted to protect the engine when the red band in tachometer **3** (overrevving range) is reached.

During normal operating conditions, coolant temperature display **4** may rise to the red mark.

**WARNING** Danger of burns when opening the hood



If you open the hood when the engine has overheated or during a fire in the engine compartment, you could come into contact with hot gases or other escaping operating fluids.

- ▶ Before opening the hood, allow the engine to cool down.
- ▶ In the event of a fire in the engine compartment, keep the hood closed and call the fire service.

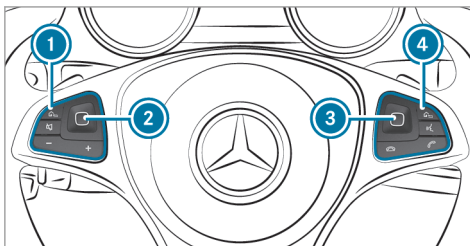
### Overview of the buttons on the steering wheel



- 1** Button group:

-  Main menu and back button (on-board computer)
-  Switches sound off/on

 Increases the volume

 Decreases the volume

**2** Touch Control (on-board computer)

**3** Touch Control (multimedia system)

**4** Button group:

 Main menu and back button (multimedia system)

 LINGUATRONIC or voice control system

 Makes/accepts a call

 Rejects/ends a call

### Operating the on-board computer

**WARNING** Risk of distraction from information systems and communications equipment

If you operate information and communication equipment integrated in the vehicle when driving, you will be distracted from the traffic situation. This could also cause you to lose control of the vehicle.

- ▶ Only operate this equipment when the traffic situation permits.
- ▶ If you cannot be sure of this, stop the vehicle whilst paying attention to road and traffic conditions and operate the equipment with the vehicle stationary.

You must observe the legal requirements for the country in which you are currently driving when operating the on-board computer.

- ⓘ The on-board computer displays appear on the multifunction display (→ page 202).

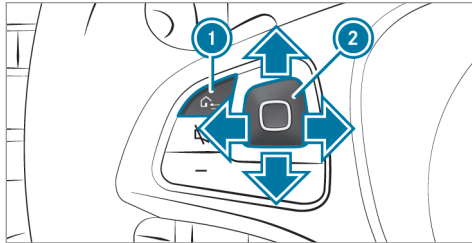

The on-board computer can be operated using Touch Control ② and back button ① on the left-hand side of the steering wheel.

Different acoustic signals provide feedback when operating the on-board computer, e.g:

- reaching the end of a list
- scrolling through a list

The following menus are available:

- [Service](#)
- [DriveAssist](#)
- [Trip](#)
- [Navigation](#)
- [Radio](#)
- [Media](#)
- [Phone](#)
- **Vehicles with an instrument display in the widescreen cockpit:** [Disp. Content](#)
- [Head-up Disp.](#)

The menus can be called up from the menu bar on the multifunction display.



- ▶ **To call up the menu bar:** press the back button on the left ①.
- ▶ **To scroll in the menu bar:** swipe to the left or right on the left-hand Touch Control ②.
- ▶ **To call up the menu or confirm the selection:** press the left-hand Touch Control ②.
- ▶ **To scroll through displays or lists on the menu:** swipe upwards or downwards on the left-hand Touch Control ②.
- ▶ **To call up a submenu or confirm the selection:** press the left-hand Touch Control ②.

▶ **To exit a submenu:** press the back button on the left ①.

If you are browsing a submenu and you press and hold the back button on the left ①, the menu bar appears.

### Setting the additional value range



Example: G-Meter

- ① Additional value range
- ② Index points

▶ **To select display content:** swipe to the right on the left-hand Touch Control.

▶ Swipe upwards or downwards on the left-hand Touch Control to select display content. When display content is selected, the additional value range ① is briefly highlighted. The index points ② display the selected list item.

The following display content can be selected in the **Classic** and **Sport** designs:

- Tachometer
- Navigation
- ECO display
- Consumption
- G-Meter

The following content can be selected in the **Progressive** design:

- Date
- Navigation
- ECO display
- Consumption
- G-Meter



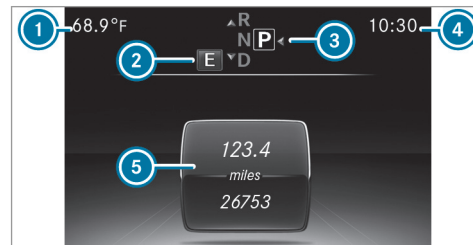





### Overview of displays on the multifunction display



- ① Outside temperature
- ② Drive program
- ③ Transmission position
- ④ Time
- ⑤ Display section

ⓘ **Vehicles with the Instrument Display in the Widescreen Cockpit:** the position of the displays deviates from those displayed here.

Further displays on the multifunction display:

- ↑ Gearshift recommendation (→ page 141)
-  Active Parking Assist activated (→ page 185)
-  Parking Assist PARKTRONIC deactivated (→ page 177)
-  Cruise control (→ page 160)
-  Active Distance Assist DISTRONIC (→ page 162)
-  Active Steering Assist (→ page 167)
-  ECO start/stop function (→ page 136)
-  HOLD function (→ page 170)
-  Adaptive Highbeam Assist (→ page 114)

**Vehicles with Traffic Sign Assist:** detected instructions and traffic signs (→ page 191).

### Adjusting the instrument lighting

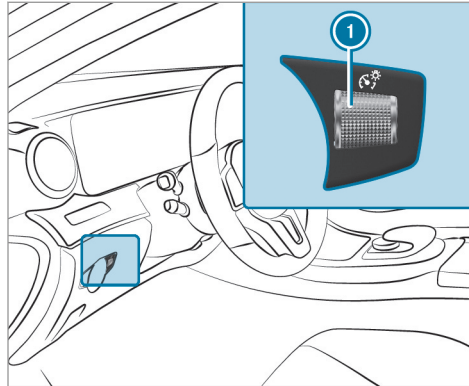

- ▶ Turn brightness control ① up or down. The lighting of the Instrument Display and in the control elements in the vehicle interior is adjusted.

### Menus and submenus

#### Functions in the Service menu of the on-board computer

On-board computer:

↳ Service

- ▶ **To select the function:** swipe upwards or downwards on the left-hand Touch Control.
- ▶ Press the left-hand Touch Control.

Functions in the **Service** menu:

- Message memory (→ page 395)
- **Tires:**
  - Restarting the tire pressure loss warning system (→ page 360)
  - Checking tire pressure with the tire pressure monitoring system (→ page 358)
  - Restarting the tire pressure monitoring system (→ page 359)
- **ASSYST PLUS:** Calling up the service due date (→ page 314)

### Calling up the assistant display

On-board computer:

→ DriveAssist

**i Vehicles with the Instrument Display in the Widescreen Cockpit:** when you have the design set to [Progressive](#), you can view the assistant display in the left-hand portion of the Instrument Display.

The following displays are available from the assistant display menu:

- Assistant display
- Attention level (→ page 189)

▶ **To switch between the displays:** swipe upwards or downwards on the left-hand Touch Control.

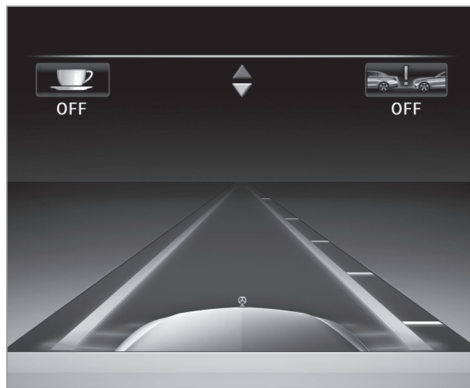

Status displays on the assistant display:

- : ATTENTION ASSIST deactivated
- : Active Brake Assist deactivated
- Light lane markings: Active Lane Keeping Assist activated
- Green lane markings: Active Lane Keeping Assist active

- Gray radar waves next to vehicle: Blind Spot Assist activated
- Green radar waves next to vehicle: Blind Spot Assist active
- Active Distance Assist DISTRONIC displays (→ page 162)

### Calling up displays in the Trip menu

On-board computer:

→ Trip

**i Vehicles with an Instrument Display in the Widescreen Cockpit:** when you have the design set to [Progressive](#), you can view information on the journey in the left-hand area of the Instrument Display.

▶ **To select a display:** swipe upwards or downwards on the left-hand Touch Control.

Displays in the [Trip](#) menu:

- Standard display
- Range and current fuel consumption

When glide mode is active (→ page 142), **Gliding Mode** is displayed instead of the current fuel consumption.

A recuperation display is also available for certain engines. If there is only a small amount of fuel left in the fuel tank, the display shows a vehicle being refueled instead of the range.

- ECO display (→ page 137)
  - Trip computer **From Start** and **From Reset**
  - Digital speedometer
- i** **Vehicles with an Instrument Display in the Widescreen Cockpit:** the digital speedometer only appears in the **Classic** and **Sport** designs.

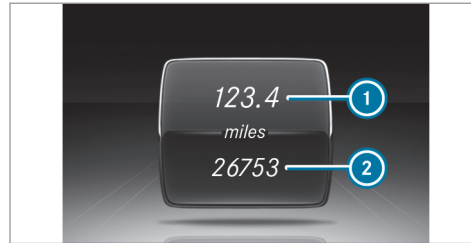

Example: standard display

- ① Trip distance
- ② Total distance recorder



Example: trip computer

- ① Total distance recorder
- ② Driving time
- ③ Average speed
- ④ Average fuel consumption

### Resetting values on the Trip menu of the on-board computer

On-board computer:

→ Trip

- ① The spelling may differ in the main menu displayed. Therefore, observe the menu overview for the Instrument Display (→ page 200).

You can reset the values of the following functions:

- Trip distance
- Trip computer **From Start** and **From Reset**
- ECO display (→ page 137)

▶ **To select the function to be reset:** swipe upwards or downwards on the left-hand Touch Control.

▶ Press the left-hand Touch Control.

▶ Select **Yes**.

▶ Press the left-hand Touch Control.

If you press and hold the left-hand Touch Control, the function will be reset immediately.

### Calling up navigation instructions in the on-board computer

On-board computer:

→ Navigation

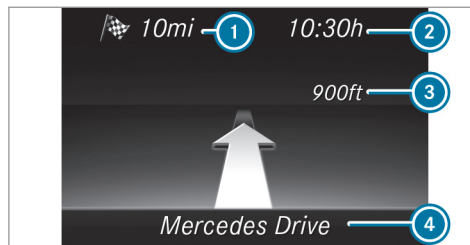

Example: no change of direction announced

- ① Distance to the next destination
- ② Estimated arrival time
- ③ Distance to the next change of direction
- ④ Current road

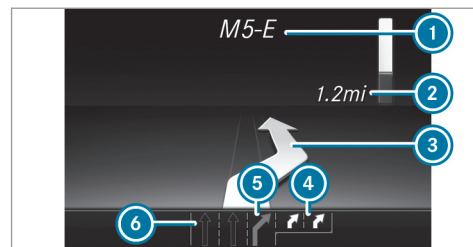

Example: change of direction announced

- ① Road to which the change of direction leads
- ② Distance to the change of direction
- ③ Change-of-direction symbol
- ④ Recommended lane and new lane during a change of direction (white)
- ⑤ Possible lane
- ⑥ Lane not recommended (dark gray)

Further possible displays on the **Navigation** menu:

- **Direction of Travel:** display of direction of travel and road currently being traveled on.



- **New Route...** or **Calculating Route...:** a new route is calculated.
- **Road Not Mapped:** the road is unknown, e.g. for newly built roads.
- **No Route:** no route could be calculated to the selected destination.
- **Off Map:** the map for the current location is not available.
- **Area of Destination Reached:** you have reached the area of destination.
-  : you have reached the destination or an intermediate destination.

▶ **To exit the menu:** press the back button on the left.

**Vehicles with the COMAND multimedia system:** You can also start navigation to one of the recent destinations on the **Navigation** menu:

- ▶ Press the left-hand touch control.
- ▶ **Select a destination:** swipe upwards or downwards on the left-hand touch control.
- ▶ Press the left-hand touch control.  
Route guidance is started.

If route guidance has already been activated, a request will appear asking whether you wish to end the current route guidance.

- ▶ Select **Yes** .
- ▶ Press the left-hand touch control.  
Route guidance is started.

## Selecting radio stations using the on-board computer

On-board computer:

▶ **Radio**



- ① Frequency range
- ② Station
- ③ Name of track
- ④ Name of artist

When you select a station in the memory presets, the preset appears next to the station name. When you select a saved station in the frequency range, an asterisk appears next to the station name.

- ▶ **To select a radio station:** swipe upwards or downwards on the left-hand Touch Control.

### Selecting the frequency range or station preset

- ▶ Press the left-hand Touch Control.
- ▶ **To select the frequency range/station preset:** swipe upwards or downwards on the left-hand Touch Control.
- ▶ Press the left-hand Touch Control.

### Media playback using the on-board computer

On-board computer:

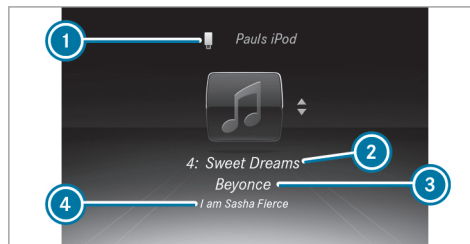

- 1 Media source
- 2 Current track and track number
- 3 Name of artist (example)
- 4 Name of album

- ▶ **To change tracks on an active media source:** swipe upwards or downwards on the left-hand Touch Control.

### Changing a media source

- ▶ Press the left-hand Touch Control.
- ▶ **To select a media source:** swipe upwards or downwards on the left-hand Touch Control.
- ▶ Press the left-hand Touch Control.

### Dialing telephone numbers using the on-board computer

#### Requirements:

- The mobile phone is connected to the multi-media system.

On-board computer:



**⚠ WARNING** Risk of distraction from information systems and communications equipment

If you operate information and communication equipment integrated in the vehicle when driving, you will be distracted from the

traffic situation. This could also cause you to lose control of the vehicle.

- ▶ Only operate this equipment when the traffic situation permits.
- ▶ If you cannot be sure of this, stop the vehicle whilst paying attention to road and traffic conditions and operate the equipment with the vehicle stationary.

When telephoning, you must observe the legal requirements for the country in which you are currently driving.

**Vehicles with the COMAND multimedia system:** The most recent telephone connections (dialed, received and missed calls) are displayed on the [Phone](#) menu.

- ▶ **Select an entry:** swipe upwards or downwards on the left-hand touch control.
- ▶ Press the left-hand touch control.  
**If there is only one telephone number saved to an entry:** the telephone number is selected.
- ▶ **If there are multiple telephone numbers saved to an entry:** swipe upwards or down-

wards on the left-hand touch control to select the desired telephone number.



- ▶ Press the left-hand touch control.  
The telephone number is dialed.

The following displays may appear instead of the telephone numbers dialed:



- **Please Wait...:** the application is starting. When a Bluetooth® connection to the mobile phone is not established, the menu for authorizing and connecting a mobile phone is displayed in the multimedia system (→ page 271).
- **Updating data...:** the call list is being updated.
- **Importing Contacts...:** the contacts from the mobile phone or from a storage medium are being imported.

#### Accepting/rejecting a call

When you receive a call, the [Incoming Call](#) message appears on the head-up display.

- ▶ Swipe upwards or downwards on the left-hand touch control and select  (Accept) or  (Reject).

- ▶ Press the left-hand touch control.

The call may be accepted/rejected using the  or  buttons on the steering wheel.

#### Adjusting the Head-up Display settings via the on-board computer

On-board computer:

↳ [Head-up Disp.](#)

The following Head-up Display settings can be adjusted:

- [Position](#)
- [Brightness](#)
- [Display Content](#)
- ▶ **To select a setting:** swipe upwards or downwards on the left-hand Touch Control.
- ▶ Press the left-hand Touch Control.
- ▶ **To adjust a value:** swipe upwards or downwards on the left-hand Touch Control.
- ▶ Press the left-hand Touch Control.

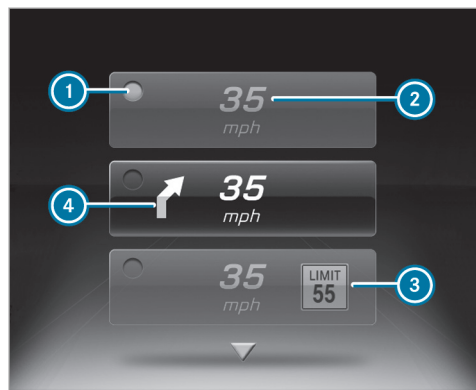

- ① Setting currently selected
- ② Digital speedometer
- ③ Traffic Sign Assist
- ④ Navigation displays

### Setting the design

On-board computer



① This function is only available for vehicles with a Widescreen Cockpit.

The following designs can be selected:

- Sport
- Classic
- Progressive

▶ **To select a design:** swipe upwards or downwards on the left-hand Touch Control.

▶ Press the left-hand Touch Control. The Instrument Display is shown in the selected design.

### Head-up Display

#### Function of the Head-up Display

The Head-up Display projects into the driver's field of vision:

- Information from the navigation system

- Information from the driver assistance systems
- Some warning messages

#### Display elements

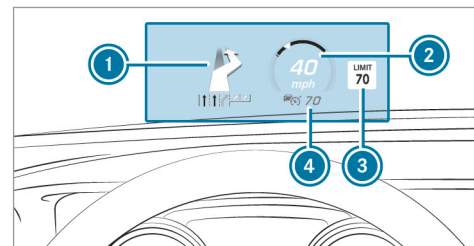

- ① Navigation messages
- ② Current speed
- ③ Detected instructions and traffic signs
- ④ Set speed in the driver assistance system (e.g. cruise control)

When you receive a call, the  Incoming Call message appears on the Head-up Display.

In audio mode, the station name or track is temporarily shown when the active audio source is being operated.

### System limitations

The visibility is influenced by the following conditions:

- Seat position
- The positioning of the display image
- Light conditions
- Wet roads
- Objects on the display cover
- Polarization in sunglasses

**i** In extreme sunlight, sections of the display may appear washed out. You can correct this by switching the Head-up Display off and on again.

### Switching the Head-up Display on/off

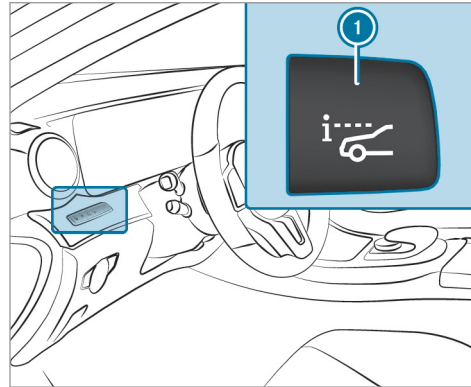

▶ Press button ①.

### Notes on operating safety

**⚠ WARNING** Risk of distraction from information systems and communications equipment

If you operate information and communication equipment integrated in the vehicle when driving, you will be distracted from the traffic situation. This could also cause you to lose control of the vehicle.

- ▶ Only operate this equipment when the traffic situation permits.
- ▶ If you cannot be sure of this, stop the vehicle whilst paying attention to road and traffic conditions and operate the equipment with the vehicle stationary.

**⚠ WARNING** Risk of distraction from operating mobile communication equipment while the vehicle is in motion

If you operate communication equipment integrated in the vehicle when driving, you will be distracted from the traffic situation.

This could also cause you to lose control of the vehicle.

Only operate this equipment when the vehicle is stationary.

For your own safety, always observe the following points when operating mobile communications equipment and especially your voice control system:





- Observe the legal requirements for the country in which you are driving.
- While driving, only operate mobile communications equipment when the traffic conditions permit it. You may otherwise be distracted from the traffic conditions and cause an accident, injuring yourself and others.
- Do not use the voice control system in an emergency as your voice can change and your telephone call can be unnecessarily delayed.
- Familiarize yourself with the voice control system functions before starting the journey.

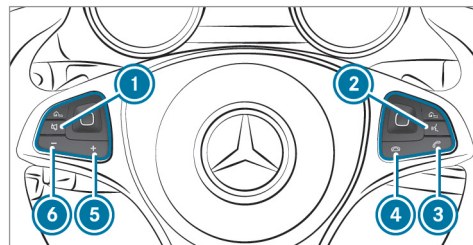

### Operation

#### Operating the multifunction steering wheel



The Voice Control System is operational approximately thirty seconds after the ignition is switched on.



- ①  Switches the sound off/on (ends The Voice Control System)
- ②  Starts the Voice Control System
- ③  Makes/accepts a call
- ④  Rejects/ends a call (ends the Voice Control System)

- ⑤  Increases the volume
- ⑥  Decreases the volume

### Conducting a dialog

- ▶ **To start or continue a dialog:** press the  button on the multifunction steering wheel. You can say a voice command after an acoustic signal.
- ▶ **To correct an entry:** say the Correction voice command.
- ▶ **To select an entry from the selection list:** say the line number or the contents.
- ▶ **To browse the selection list:** say the Continue or Back voice command.
- ▶ **To interrupt the dialog:** say the Pause voice command.
- ▶ **To cancel the dialog:** say the Cancel voice command or press the  button on the multifunction steering wheel.

### Operable functions

You can use the Voice Control System to operate the following equipment depending on the features:

- Telephone
- Text messages
- Navigation
- Address book
- Radio
- Audio (memory card, Media Interface, USB and Bluetooth® audio)
- Vehicle

### Overview of types of voice commands

A distinction is made between the following voice commands:

- **Global voice commands** can be said at any time and regardless of the current application, e.g. the voice commands Navigate to, Call or Text message to.

- **Application-specific voice commands** are only available for the active application.

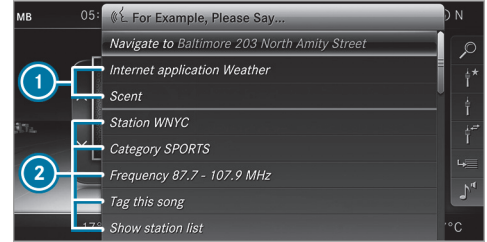

- ① Global voice commands
- ② Application-specific voice commands

On the display next to the active application, examples of global voice commands and the corresponding application-specific voice commands are displayed on an autocue. This makes entry easier and supports interactive operation. The list can be scrolled or it can be operated by speech or the controller/touchpad.

### Number entry functions

- The numbers allowed are zero to nine.
- Telephone numbers can be entered as single digits.

### Information on the language setting

You can change the language of the Voice Control System via the system language settings. If the set system language is not supported by the Voice Control System, English will be selected. The Voice Control System is available for you in English, French and Spanish.

### Using the Voice Control System effectively

#### Function of audible help functions

You receive information and help for:

- **Optimal operation:** say the Help voice control system voice command.

- **Current application:** press the  button on the multifunction steering wheel and say the Help voice command.
- **Continued dialog:** say the Help voice command during a voice dialog.
- **A specific system:** say the voice commands for the desired system, e.g. Help telephone.

### Notes on how to improve speech quality

**If the Voice Control System does not understand you:**

- only operate the Voice Control System from the driver's seat.
- say the voice commands coherently and clearly, but do not exaggerate the words.
- avoid loud noises that cause interference while making a voice command entry, e.g. the blower.

- say the voice tag with the same intonation when creating voice tags.

**If an address book entry voice tag is not recognized:**

- only create sensible address book entries in the system/mobile phone, e.g. enter surname and first name in the correct field.
- do not use any abbreviations, unnecessary spaces or special characters.

**If a station list entry is not recognized:**

- say the Read out station list voice command.

### Essential voice commands

#### Overview of switch voice commands

Switch voice commands can be used to open certain applications. The voice command selection can be used regardless of the application that is currently active.



<b>Voice command</b>	<b>Function</b>
Navigation	To switch to navigation mode
Map	To switch to map display
Address book	To switch to address book
Telephone	To switch to telephone mode
Text message	To switch to text messages
Radio	To switch to radio mode
Media	To switch to media mode
USB	To switch to USB
Memory card	To switch to memory card
Internet application <Name>	To start a Mercedes-Benz online application. The application must be called up by touch once prior to use.
Mercedes-Benz Apps	To switch to Mercedes-Benz Apps
Connect	To switch to Internet mode

Voice command	Function
Vehicle	To switch to vehicle settings
System settings	To switch to system settings

### Overview of navigation voice commands

Using navigation voice commands, you can enter POIs or conventional addresses as well as directly change important navigation settings.

Voice command	Function
Navigate to <Address/POI/Contact>	Universal search for all types of destinations. A search is also conducted in the address book contacts, the navigation database and on the Internet (POIs). The order of the details, e.g. city, street or house number, can be changed.
Address in <Country>	Destination entry in a desired country, e.g. address in France
POI <POI>	Destination entry for a POI, e.g. the POI Brandenburg Gate. A search is also performed in the navigation database and on the Internet.
POI online search <POI>	Conducts a POI search on the Internet only
Navigate to contact <Name>	Destination entry to a contact in the address book

Voice command	Function
Enter country Enter town Enter district Enter street Enter intersection Enter house number Enter ZIP code	Enters a country/city/district/street/intersection/house number/ZIP code
Nearest restaurant Nearest parking lot Nearest rest area with restrooms Nearest gas station	Searches for nearby restaurants, parking lots and gas stations
Last destinations	Selects a destination from the list of last entered destinations
Alternative routes	Switches route guidance to another route
Start route guidance	Starts route guidance after entering a valid destination
Cancel route guidance	Cancels route guidance

Voice command	Function
Guidance instructions on Guidance instructions off	Switches the route guidance voice output on/off
Show traffic map Hide traffic map	Switches the traffic map on/off
Switch on POI symbols Switch off POI symbols	Switches the POI symbols display on the map on/off

### Overview of telephone voice commands

You can use the telephone voice commands to make phone calls or search through the address book.

Voice command	Function
Call <Name>	Makes a phone call. All address book names are available.
Search for contact <Name>	Searches for and displays a contact. All address book names are available.
Last phone number	Displays the last call
Redial	Selects the last phone number dialed

### Overview of radio voice commands

Radio voice commands can also be used when the radio application is running in the background.

Voice command	Function
Station <Name>	To call up receivable or saved stations
<Frequency>	To enter a frequency directly
Next station Previous station	To switch to the next available station
Save station	To save a station in the station list
Show station list	To display the names of all receivable stations
Read out station list	To listen to the names of all receivable stations
Traffic information on Traffic information off	To switch the traffic information service on/off
Radio info on Radio info off	To switch the current station information on/off

### Overview of media player voice commands

Media player voice commands can also be used when the media player runs in the background.

Voice command	Function
Play <Track>	The names of all available tracks are accepted during the search
Media search <Track>	The names of all available tracks are accepted during the search
Show all albums Show all artists Show all composers Show all genres Show all tracks Show all playlists	Available albums, artists, composers, genres, tracks or playlists are searched for.
Next track	To select the next track
Previous track	To select the previous track
Random track list on Random track list off	To switch the random track list on/off

### Overview of message voice commands

Text messages can be created, edited and listened to using the message voice commands.

Voice command	Function
Text message to <Name>	To create a message. All address book names are available.
Reply	To reply to a message
Forward text message	To forward a message

### Overview of vehicle voice commands

You can use the vehicle voice commands to directly call up the corresponding menus for the vehicle settings.

Voice command	Function
Ambient light	To display ambient light settings
Display settings	To show display settings
Assistance settings	To display assistance settings
Scent	To display fragrance settings
Energy flow	To display energy flow settings
Ionization	To display ionization settings
Climate control	To display climate control settings

## 222 Voice Control System

---

Voice command	Function
Light	To display light settings
Massage	To display massage settings
Engine data	To display engine data
Seats	To display seat adjustment settings
Consumption	To display consumption
Visualization	To display visualization



## Overview and operation

### Overview of the multimedia system

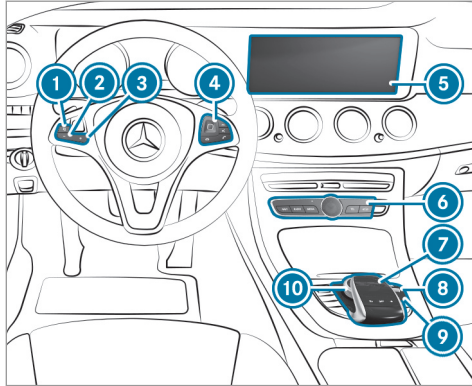

- ① Switches the sound on/off
- ② Decreases the volume
- ③ Increases the volume
- ④ Touch Control
- ⑤ Media display

- ⑥ Main function button group (→ page 226)
- ⑦ Touchpad
- ⑧ Volume control  
Adjusts volume and switches the sound on/off
- ⑨ button  
Switches multimedia system on/off
- ⑩ Controller

### Notes on the media display

#### NOTE Scratching of the display

The display has a highly sensitive, high-gloss surface. There is a risk of it becoming scratched.

Avoid touching the display.

Observe the notes on cleaning.

Observe the notes on caring for the interior (→ page 329).

**Automatic temperature-controlled switch-off feature:** if the temperature is too high, the

brightness is initially reduced automatically. The media display may then switch off completely for a while.

- ① If you are wearing polarized sunglasses, it may be difficult to read the media display.

### Central control elements overview

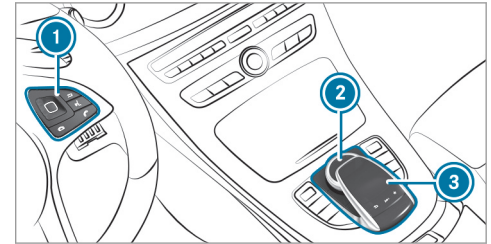

- ① Touch Control
- ② Controller
- ③ Touchpad

## Touch Control

### Operating Touch Control

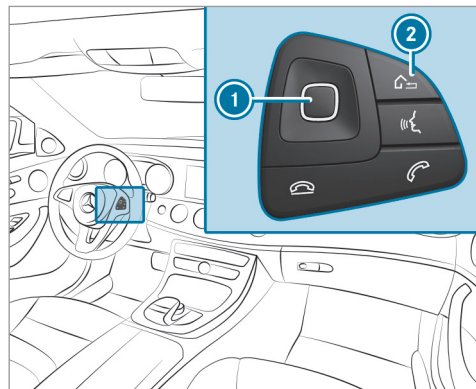

- ▶ **To select a menu item:** swipe up, down, left or right on Touch Control ①.
- ▶ Press Touch Control ①.
- ▶ **To open a list:** press Touch Control ①.
- ▶ **To close a list:** press the ② button.

- ▶ **To call up the menu list/favorites:** hold button ②.
- ▶ **To move the digital map:** swipe in any direction.

### Setting the sensitivity for Touch Control



Multimedia system:

➔ System ➔  Input ➔ Touch Control Sensitivity

- ▶ Select **Fast**, **Medium** or **Slow**.

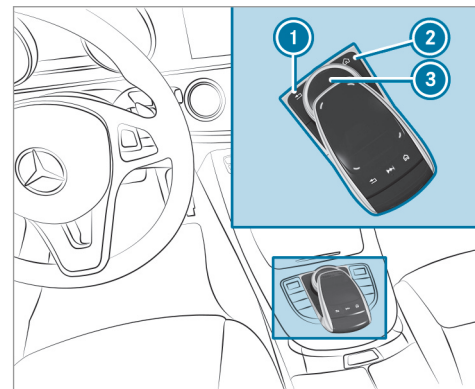
## Operating the controller



- ①  button  
Press briefly: returns to the previous display  
Press and hold: calls up main functions
- ②  button  
To call up the main functions

To call up favorites: when the main functions are displayed, slide controller ③ down.

### ③ Controller

Controller operating options:

- ▶ Turn left or right.
- ▶ Slide left or right.
- ▶ Slide up or down.
- ▶ Slide diagonally.
- ▶ Press briefly or press and hold.

## Touchpad

### Activating/deactivating the touchpad

Multimedia system:

System Input

- ▶ Activate  or deactivate  the Touchpad.

### Operating the touchpad

#### Requirement:

For vehicles with a controller: the touchpad is switched on (→ page 225).

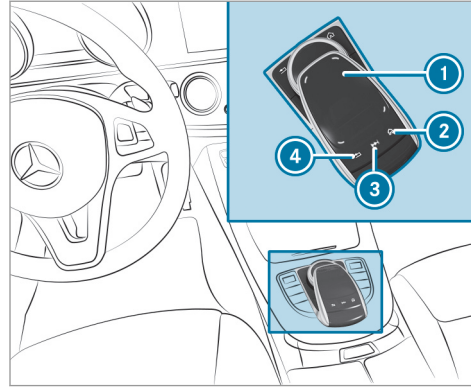

- ① Touchpad
- ② Button Calls up main functions and favorites
- ③ Button Calls up the control menu of the last active audio source
- ④ Button

Press briefly: returns to the previous display  
Press and hold: calls up main functions

You can navigate in menus and lists via touch-sensitive surface ① by using a **single-finger swipe**.

- ▶ **To open or close lists:** swipe left or right.
- ▶ **To select the menu item:** swipe up, down, left or right.
- ▶ Press touchpad ①.
- ▶ **To move the digital map:** swipe in any direction.

**Use the following functions with a two-finger swipe:**

- ▶ **To call up main functions and favorites:** swipe down with two fingers.
- ▶ **To zoom in and out of the map:** move two fingers together or apart.
- ▶ **To call up the control menu of the last active audio source:** swipe up with two fingers.

### Setting the sensitivity for the touchpad

Multimedia system:

→ System →  Input

- ▶ Select **Touchpad Sensitivity**.
- ▶ Select **Fast**, **Medium** or **Slow**.
- ▶ **To set the pressure sensitivity:** switch **Touchpad Tap** on  or off . If the function is switched on , a tap on the touchpad is enough to select a menu item.

### Handwriting recognition: switching the read-aloud function on/off

Multimedia system:

→ System →  Audio → System Feedback

- ▶ Switch **Read Out Handwriting Recognition** on  or off .

### Activating/deactivating haptic feedback for operation on the touchpad

Multimedia system:

→ System →  Input

The function supports you when making entries on the touchpad and when selecting menus.

- ▶ Switch **Haptic Operating Feedback** on or off. When the function is activated, a tactile feedback in the form of a vibration is effected when the touchpad is operated.

### Selecting a station and track using the touchpad

- ▶ Press the  button on the touchpad.  
or
- ▶ Swipe upwards using two fingers on the touchpad. The control menu appears for the audio source that was last selected.
- ▶ Use one finger to swipe up or down. Radio: the previous or the next station is set. Media source: the previous or the next music track is selected.

- ▶ **To hide the control menu:** swipe down on the touchpad using two fingers.

## Main functions

### Calling up the main functions

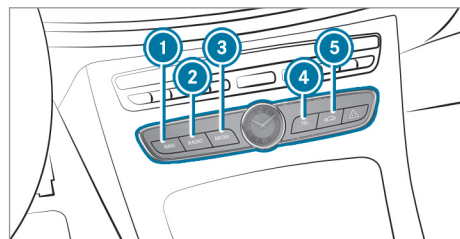

- ① **NAVI** button  
To call up navigation
- ② **RADIO** button  
To call up the radio
- ③ **MEDIA** button  
To call up media
- ④ **TEL** button  
To call up the telephone

5



button

To set vehicle functions

- ▶ Alternatively: press the  button on the controller, the touchpad or the Touch Control. The main functions are displayed.
- ▶ Select the main function.

### Calling up lists and menus on the multimedia system

#### Call up a list

- ▶ Call up a main function (→ page 226).
- ▶ **To open a list:** swipe left on the touchpad.
- ▶ **To close a list:** swipe right on the touchpad.
- ▶ **To select a menu item:** swipe up or down on the touchpad.
- ▶ Press the touchpad.

## Favorites

### Overview of favorites

Favorites offer you quick access to frequently used applications. It is possible to create 20 favorites in total.

The following functions are available:

- add **pre-defined favorites** from the following categories (→ page 227):
  - [Navigation](#)
  - [Entertainment](#)
  - [Phone](#)
  - [Connect](#)
  - [Vehicle](#)
  - [System Settings](#)
- add **your own favorites** (→ page 227).
- rename a favorite (→ page 228).
- move a favorite (→ page 228).
- delete a favorite (→ page 228).
- reset all favorites (→ page 228).

### Calling up favorites

- ▶ Press the  button. The main functions are displayed.
- ▶ Navigate downwards once. Navigating means:
  - Swiping on Touch Control or the touchpad
  - Sliding the controller

### Leaving the favorites menu

- ▶ Press the  button.

### Adding a favorite

#### Adding a pre-defined favorite



- ▶ Press the  button. The main functions are displayed.
- ▶ Navigate downwards twice. The Favorites menu appears.
- ▶ Select [New Favorite](#). The categories are displayed.
- ▶ Select a category. The favorites are displayed.
- ▶ Select a favorite.

- ▶ Store the favorite at the desired position.  
If a favorite has already been added at this position, it will be overwritten.

#### Example: adding your own favorite

- ▶ Select **Vehicle**.
- ▶ Select **Full Screen: Consumption**.
- ▶ Press and hold the  button until the favorites are displayed.
- ▶ Store the favorite at the desired position.

#### Renaming a favorite

- ▶ Press the  button.  
The main functions are displayed.
- ▶ Navigate downwards once.
- ▶ Select a favorite.
- ▶ Navigate downwards once.  
The Favorites menu appears.
- ▶ Select **Rename**.
- ▶ Enter the characters.
- ▶ **To confirm the entry:** select .

#### Moving a favorite

- ▶ Press the  button.  
The main functions are displayed.
- ▶ Navigate downwards once.
- ▶ Select a favorite.
- ▶ Navigate downwards once.  
The Favorites menu appears.
- ▶ Select **Move**.
- ▶ Move the favorite to the desired position.  
If a favorite has already been added at this position, it will be overwritten.

#### Deleting a favorite

- ▶ Press the  button.  
The main functions are displayed.
- ▶ Navigate downwards once.
- ▶ Select a favorite.
- ▶ Navigate downwards once.  
The Favorites menu appears.
- ▶ **To delete:** select **Delete**.
- ▶ Select **Yes**.

- ▶ **To restore all favorites:** select **Reset All**.  
A prompt appears.
- ▶ Select **Yes**.  
The favorites are reset to the factory settings.

#### Switching the sound on or off

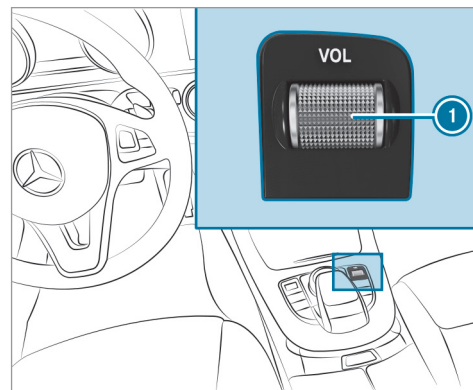

- ▶ **To mute:** press volume control ①.  
The  symbol appears in the status line.  
You will also hear traffic announcements and navigation announcements even when the sound is muted.
- ▶ **To switch on:** change the media source or adjust the volume.

### Adjusting the volume

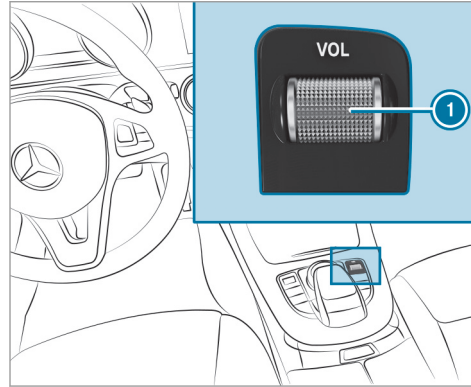

On the multimedia system

- ▶ Turn volume control ①.  
The volume of the current radio or media source is set. The volume of other audio sources can be adjusted separately.

Adjust this in the following situations:

- during a traffic announcement
- during a navigation announcement  
The volume of the navigation announcement changes in accordance with the volume of the current media source.
- during a telephone call
- when entering or exiting a parking space while using Active Parking Assist

or

- ▶ Select **System**.
- ▶ Select **Audio**.
- ▶ Select a volume setting.
- ▶ Set the volume.

### Entering characters

#### Using the character input function

Use the character input function in the following situations, for example:

- To rename a favorite
- To enter a POI or address

- To make a phone call

The following functions are available:

- Selecting a character in the character bar
- Writing a character on the touchpad

Character input can be started with a control element and resumed with another.

▶ **On the Touch Control and controller:** select a character in the character bar.

Depending on the target entry, the following characters are available:

- The full set of characters is shown
  - Only those characters which are useful for the current input string are shown
- Other characters are grayed out.

▶ **On the touchpad:** select a character in the character bar.

or

▶ Write the characters on the touch-sensitive surface of the touchpad.

Handwriting recognition supports you by means of character suggestions and a read-aloud function.

Examples of character entry:

- Rename a favorite
- Enter a POI or an address using free or step-by-step search
- Enter a web address

### Entering characters using the controller.

#### Example: renaming a favorite

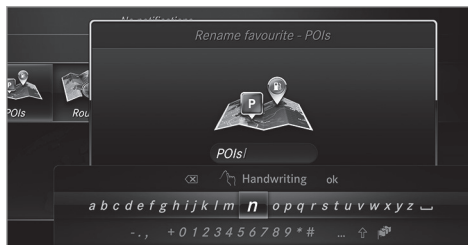

▶ Call up the "Renaming a favorite" function (→ page 228).

▶ **To enter a character:** turn **[⊙]**, slide **↑⊙↓** and press the controller. The character is entered in the input line.

Use the following entry functions:

**[<X]** To delete a character: press the controller.

To delete an entry: press and hold the controller until the entire entry is deleted.

**[...]** To switch to special characters and symbols.

**[↑]** To switch to upper-case or lower-case letters.

**[👉]** To switch the language.

**[👉]** To switch to character entry on the touchpad.

**[i]** The available editing functions depend on the editing task, the language set and the character level.

▶ **To confirm the entry:** select **[OK]**.

#### Example: entering a destination (navigation)

▶ Enter the POI or address (→ page 246).

### Entering characters on the touchpad

#### Requirements

- The touchpad is switched on (→ page 225).



- The entered or selected character should be read out: the handwriting recognition read-aloud function is switched on (→ page 226).

### Example: renaming a favorite



- ▶ Call up the "Renaming a favorite" function (→ page 228).
- ▶ **To enter a character:** use your finger to write characters on the touchpad. The character is entered in the input line. If different interpretations are possible, character suggestions are displayed.
- ▶ **To select a character suggestion:** turn the controller.

- ▶ Resume character input.
  - ▶ **To enter a space:** swipe right when the cursor is located in the input line.
  - ▶ **To delete a character:** swipe left when the cursor is located in the input line.
  - ▶ **To confirm the entry:** press the touchpad.
  - ▶ **To finish character entry:** swipe upwards.
- or
- ▶ Press the  button.

### Example: entering a destination (navigation)

- ▶ Enter the POI or address (→ page 246).

## System settings

### Display

#### Configuring display settings

Multimedia system:

↳ System ▶ ▶  Display and Designs

#### Designs

- ▶ Select [Designs](#).
- ▶ Select [Sport](#), [Classic](#) or [Progressive](#).

#### Adapting the ambient lighting for the style

- ▶ Select [Adjust Amb. Lighting](#).  
Activate  or deactivate  the function.  
This function adjusts the ambient lighting for the selected display style.

#### Additional display area

Depending on the vehicle, various items of additional information can be shown. The additional display area comprises the left-hand or right-hand third of the display.

- ▶ Select [Additional Disp. Area](#).

The following display content can be selected:

- [Dynamic](#)
- [Navigation Map](#)
- [Consumption](#)
- [Time and Date](#)

#### Display brightness

- ▶ Select [Display Brightness](#).
- ▶ Select a brightness value.

### Switching the display off/on

- ▶ **Off:** select **Display off**.
- ▶ **On:** press a button, [TEL], for example.

### Display design

- ▶ Select **Day/Night Design**.
- ▶ Select **Automatic, Day Design** or **Night Design**.

### Time and date

#### Setting the time and date automatically

Multimedia system:

↳ System ▶ [31] Time and Date

- ▶ Deactivate  **Manual Time Adjustment**.  
The time and date are set automatically for the selected time zone and summer time option.

ⓘ The correct time is required for the following functions:

- Route guidance with time-dependent traffic guidance.
- Calculation of expected time of arrival.

#### Setting the time zone

Multimedia system:

↳ System ▶ [31] Time and Date ▶ Time

Zone:

The list of countries is displayed.

- ▶ Select a country •.  
Depending on the country, time zones are displayed.
- ▶ Select a time zone.  
The time zone set is displayed after **Time Zone**:

#### Setting summer time

The **Automatic Daylight Saving Time** and **Daylight Saving Time** options cannot be selected in all countries.

Multimedia system:

↳ System ▶ [31] Time and Date

#### Automatically

- ▶ Switch **Automatic Daylight Saving Time** on  or off .

#### Manually

- ▶ Deactivate  **Automatic Daylight Saving Time**.
- ▶ Select **Daylight Saving Time**.
- ▶ Select **On** or **Off**.

#### Setting the time and date format

Multimedia system:

↳ System ▶ [31] Time and Date ▶ Set Format

- ▶ Set the date and time format •.

#### Setting the time manually

##### Requirement

- The **Manual Time Adjustment** function is switched on.

Multimedia system:

↳ System ▶ [31] Time and Date ▶ Set Time

- ▶ Set the hours.
- ▶ Navigate to the right to set the minutes.
- ▶ Set the minutes.

- ▶ Confirm changes when exiting the menu.

The date is set automatically via GPS.

## Connectivity

### Switching transmission of the vehicle position on/off

Multimedia system:

↳ System ▶  Connectivity

- ▶ Select **Transmit Vehicle Position**.
- ▶ Switch the function on  or off .

## Bluetooth®

### Information about Bluetooth®

Bluetooth® technology is a standard for short-range wireless data transfer up to approximately 32.8 ft (10 m). You can use Bluetooth® to connect your mobile phone to the multimedia system and use the following functions, for example:

- hands-free system with access to the following options:

- contacts (→ page 274)
- call lists (→ page 277)
- text messages
- Internet connection
- listening to music via Bluetooth® audio (→ page 301)
- transferring business cards (vCards) into the vehicle

Bluetooth® is a registered trademark of Bluetooth Special Interest Group (SIG) Inc.

- ⓘ Internet connection via Bluetooth® is not available in all countries.

### Activating/deactivating Bluetooth®

#### Requirement

- Apple CarPlay™ is not active.

Multimedia system:

↳ System ▶  Connectivity

- ▶ Activate  or deactivate  Bluetooth®.

If Android Auto is active, a prompt appears asking whether Bluetooth® should be deactivated.

- ▶ Select **Yes**.  
Android Auto is closed and Bluetooth® is deactivated.

## Wi-Fi

### Wi-Fi connection overview

You can use Wi-Fi to establish a connection with a Wi-Fi network and to access the Internet or other network devices.

The following connection options are available:

- Wi-Fi connection  
The Wi-Fi connection to a Wi-Fi-capable device, e.g. the customer's mobile phone or a tablet PC is established.
- multimedia system as a Wi-Fi hotspot  
Using this function, a tablet PC or notebook can be connected, for example.

To establish a connection, you can use the following methods:

- WPS PIN

The connection to a secure Wi-Fi network is made via a PIN.

- WPS PBC

The connection to a secure Wi-Fi network is made by pressing a button (push button).

- security key

The connection to a secure Wi-Fi network is made via a security key.

### Setting up Wi-Fi

#### Prerequisite

- The device to be connected supports one of the three means of connection described (→ page 233).

Multimedia system:

↳ System ▶▶  Connectivity

#### Activating/deactivating Wi-Fi

▶ Switch **Wi-Fi** on  or off .

If **Wi-Fi** is deactivated , communication via Wi-Fi to all devices is interrupted. This also means that a connection to the HERMES communication module cannot be estab-

lished. Then functions such as dynamic route guidance with Live Traffic Information are not available.

#### Connecting the multimedia system with a device via Wi-Fi

This function is available if a HERMES communication module is not installed.

The type of connection established must be selected on the multimedia system and on the device to be connected.

 The connection procedure may differ depending on the device. Follow the instructions that are shown in the display. Further information (see the manufacturer's operating instructions).

- ▶ Select **Internet Settings**.
- ▶ Select **Search for Wi-Fi Networks**.

#### Using a WPS PIN:

- ▶ Highlight a Wi-Fi network in the list.
- ▶ Select  **Connect via WPS PIN Input**. The multimedia system generates an eight-digit PIN.

- ▶ Enter this PIN on the device to be connected.
- ▶ Confirm the entry.

#### Using a button:

Requirements



- This function is only available in a Wi-Fi frequency of 2.4 GHz.
- ▶ Highlight a Wi-Fi network in the list.
  - ▶ Select  **Connect via WPS PBC**.
  - ▶ Select "Connect via WPS PBC" in the options on the device to be connected.
  - ▶ Press the WPS button on the device to be connected.
  - ▶ Select **Continue** in the multimedia system.

#### Using a security key:

- ▶ Highlight a Wi-Fi network in the list.
- ▶ Select  **Connect Using Security Key**.
- ▶ Have the security key displayed on the device to be connected (see the manufacturer's operating instructions).

- ▶ Enter this security key on the multimedia system.
- ▶ Confirm the entry with **OK**.
- ⓘ All devices support a security key as a means of connection.

#### Device has already been connected:

- ▶ **To automatically connect:** highlight a Wi-Fi network in the list.
- ▶ Activate  **Connect Automatically** .
- ▶ **To connect:** highlight a Wi-Fi network in the list.
- ▶ Select  **Connect**.  
The connection is established again. These functions are possible when the device has already been connected to the Wi-Fi network.

#### Setting up a Wi-Fi hotspot

Multimedia system:

↳ System ▶  Connectivity

#### Configuring the multimedia system as a Wi-Fi hotspot

The type of connection established depends on the device to be connected. The function must

be supported by the multimedia system and by the device to be connected. The type of connection established must be selected on the multimedia system and on the device to be connected.

- ▶ Select **Set Up Hotspot**.
- ▶ Highlight **Connect Device to Vehicle Hotspot**.

#### Generating a WPS PIN

- ▶ Select  **Connect via WPS PIN Generation**.
- ▶ Enter the PIN shown in the multimedia system display on the device to be connected and confirm.

#### Connecting using a WPS PIN

- ▶ Select  **Connect via WPS PIN Input**.
- ▶ Select **Enter WPS PIN**.
- ▶ Enter the PIN that is shown on the external device's display on the multimedia system.
- ▶ Select **Continue**.

#### Connecting using a button

Requirements

- This function is only available in a Wi-Fi frequency of 2.4 GHz.
- ▶ Select  **Connect via WPS PBC**.
  - ▶ Press the WPS button on the device to be connected or select **Connect**.
  - ▶ Select **Continue** in the multimedia system.

#### Connecting using a security key

- ▶ Select **Connect Device to Vehicle Hotspot**.  
A security key is displayed.
- ▶ Select the vehicle from the device to be connected. The vehicle is displayed with the SSID **MB Hotspot XXXXX**.
- ▶ Enter the security key which is shown in the multimedia system display on the device to be connected.
- ▶ Confirm the entry.

#### Connecting using NFC

- ▶ Select **Connection via NFC**.

- ▶ Activate NFC on the mobile device (see the manufacturer's operating instructions).
- ▶ Bring the mobile device into the NFC area of the vehicle (→ page 272).
- ▶ Select **Done**.  
The mobile device is now connected to the multimedia system hotspot via NFC.

#### To generate a new security key:

- ▶ Select **Set Up Hotspot**.
- ▶ Select **Generate Security Key**.  
A connection will be established with the newly created security key.
- ▶ **To save a security key:** select **Save**.  
When a new security key is saved, all existing Wi-Fi connections are then disconnected. If the Wi-Fi connections are being re-established, the new security key must be entered.

### Managing COMAND Touch devices

#### Requirements

- The COMAND Touch app is installed on the external device (e.g. tablet or smartphone).

- Wi-Fi is activated (→ page 234) and the multimedia system is configured as a Wi-Fi hotspot (→ page 235).

Multimedia system:

↳ System ▶ COMAND Touch

#### Connecting a new device

- ▶ Select **Authorize a New Device**.
- ▶ Select **Connect New Device**.
- ▶ **Accept** the connection request from the new device.  
A security key is displayed.
- ▶ Enter the security key in the external device.  
The device is authorized.

#### Selecting a connected device

- ▶ Select **Authorize a New Device**.  
The devices already connected are displayed.
- ▶ Select **Continue Using Connected Devices**.  
The **Please start COMAND Touch on your device and follow the instructions** message appears.

- ▶ Select **Continue**.  
Follow the instructions to authorize the selected device.

#### De-authorizing the device

- ▶ Select a connected device from the list.  
The **Please start COMAND Touch on your device and follow the instructions** message appears.
- ▶ Select **Continue**.  
A prompt will appear asking whether you would like to de-authorize the selected device.
- ▶ Select **Yes**.  
The device is de-authorized.

### Activating/deactivating child safety lock

Multimedia system:

↳ System ▶ Parental Control

#### Locking an external device

- ▶ Select an external device.

- ▶ Select **Lock**.  
The device connected via the COMAND Touch App is locked  or unlocked .

## System language

### Notes on the system language

This function allows you to determine the language for the menu displays and the navigation announcements. The selected language affects the characters available for entry. The navigation announcements are not available in all languages. If a language is not available, the navigation announcements will be in English.

### Setting the system language

Multimedia system:

↳ System ▶ Language

- ▶ Set the language.
- ⓘ If you are using Arabic map data, the text information can also be shown in Arabic on the navigation map. To do so, select العربية as the language from the language list. Navigation announcements are then also made in Arabic.

## Setting the distance unit

Multimedia system:

↳ System ▶ Units

- ▶ Select **km** or **mi**.
- ▶ In the multifunction display of the Instrument Display, switch the **Additional Speedometer** display on .

## Data import and export

### Data import/export function

The following functions are possible:

- transferring data from one system or vehicle to another system or vehicle.
- creating a backup copy of your personal data and loading it again.
- protecting your personal data against unwanted export with PIN protection.
- ⓘ Please note that the NTFS file system is not supported. The FAT32 file system is recommended.

## Importing/exporting data

### NOTE Data loss

- ▶ Do not remove the data storage medium when data is being exported.

Mercedes-Benz is not liable for any loss of data.

### Requirements

- The vehicle is stationary.
- The ignition is switched on or the vehicle has been started.
- The SD card is inserted (→ page 294) or the USB device is connected (→ page 296).

Multimedia system:

↳ System ▶ System Backup

- ▶ Select **Import Data** or **Export Data**.

### Importing

- ▶ Select a data storage medium.  
A prompt appears asking whether you really wish to overwrite the current data. If data

originates from another vehicle, this is recognized during data reading.

The multimedia system is restarted once the data has been imported.

- ❗ Current vehicle settings can be edited after the import.

### Exporting

If PIN protection is activated, your PIN is requested.

- ▶ Enter the four-digit PIN.
- ▶ Select a data storage medium.  
The data is exported. The data export may take several minutes.

### Activating/deactivating PIN protection for data export

Multimedia system:

↳ System ▶▶ System Backup

- ▶ **To activate:** activate **PIN Protection** .
- ▶ Enter your four-digit PIN.
- ▶ Enter your four-digit PIN again.  
PIN protection is activated when both PINs match.

- ▶ **To deactivate:** deactivate **PIN Protection** .
- ▶ Enter your four-digit PIN.

- ❗ If you have forgotten your PIN, an authorized Mercedes-Benz Center can deactivate your PIN protection for you.  
Alternatively: you can deactivate PIN protection by resetting your personal data (→ page 242).

### Activating/deactivating PIN protection

Multimedia system:

↳ System ▶▶ PIN Protection

#### Setting the PIN

- ▶ Select **Set PIN**.
- ▶ Enter a four-digit PIN.
- ▶ Enter the four-digit PIN again.  
If both PINs match, PIN protection is active.

#### Changing the PIN

Requirement

- A current PIN must be set.

- ▶ Select **Change Settings**.
- ▶ Enter the current PIN.
- ▶ Select **Change PIN**.
- ▶ Set a new PIN.

#### Activating PIN protection for data export

- ▶ Select **Change Settings**.  
Confirm with the PIN.
- ▶ Select **Protect Data Export**.  
Activate  or deactivate  the function.

#### Activating PIN protection for offline mode

- ▶ Select **Change Settings**.  
Confirm with the PIN.
- ▶ Select **Protect Deactivation of Offline Mode**.  
Activate  or deactivate  the function.

#### Unblocking the PIN

Requirements

- There is an Internet connection.
- A Mercedes me account exists at <http://www.mercedes.me>.



- The **Personalization** service is active (→ page 239).

If the PIN has been entered incorrectly three times, the PIN will be blocked. You can have a single-use password sent to you via the Mercedes me connect online portal to reset the PIN protection.

- ▶ Select **Unblock PIN**.
- ▶ Enter the single-use password. PIN protection is reset, and you can set a new PIN.

- ⓘ Alternatively, you can have PIN protection reset at an authorized Mercedes-Benz Center.

## User profile

### Setting a user profile

Multimedia system:

↳ System ▶  Personalization

### Displaying a user profile when starting

If this function is active, a prompt appears when starting the system asking which user profile to use.

- ▶ Select **Display Profile Selection after Start**.
- ▶ Activate  or deactivate  the function.

### Selecting a user profile

- ▶ Select **Guest Profile** or individual profile ●.
- ⓘ Some settings from the user profile are only loaded when the vehicle is stationary or when the ignition is switched on.

### Automatic synchronization

Each time the ignition is switched off or on, the individual user profiles are synchronized on the multimedia system and on the server. This ensures that the latest user profiles are always available.

- ▶ Select **Automatic Synchronization**.
- ▶ Activate  or deactivate  the function.
- ⓘ For more information about importing/exporting user profiles (→ page 239).

### Creating a user profile

Multimedia system:

↳ System ▶  Personalization ▶ **Create Profile**

- ▶ Enter a name.
- ▶ Select **OK**.

Individual settings are saved in the user profile, e.g.:

- System settings
- Settings in the TV tuner's channel list
- Navigation and traffic information

The settings differ depending on the vehicle equipment.

### Importing/exporting user profiles

#### Requirements:

- There is an Internet connection .

- A Mercedes me account exists at <http://www.mercedes.me>.
- The **Personalization** service is active.

Multimedia system:

→ System »  Personalization » Manual Export/Import

This function is not available in all countries.

Only individual profiles can be imported or exported.

The individual profiles are always collectively imported or exported.

▶ **Import:** select **Import Profiles from Server**.  
The **The profile data import overwrites all existing profile data. Do you want to continue?** message appears.

▶ Select **Yes**.  
User profiles are imported.

▶ **Export:** select **Export Profiles to the Server**.  
User profiles are exported.

ⓘ Certain settings, such as address book entries or previous destinations from the navigation system, are not exported.

### Setting user profile options

Multimedia system:

→ System »  Personalization

- ▶ Highlight a profile.
- ▶ Select  options.

The following options are available:

- **Rename**
  - **Delete**
  - **Reset**
- ⓘ The guest profile cannot be deleted or renamed.

### Software update

#### Information on software updates

The multimedia system provides a message when an update is available.

Depending on the source, you can perform various updates:

### Software update

Source of the update	Update type
Internet	Navigation map, system updates, Digital Operator's Manual
External storage medium, e.g. USB flash drive	Navigation maps

Software updates ensure your vehicle's technology is always up-to-date.

In order to constantly improve the quality of our services you will receive future updates for your multimedia system, the Mercedes-Benz mbrace® services and your vehicle's communication module. These will conveniently be sent to you via the mobile phone connection in your vehicle and, in many cases, installed automatically. You can monitor the status of your updates at any time on the Mercedes me portal and find information about potential innovations.

Your advantages at a glance:

- conveniently receive software updates via the mobile phone network
- the long-term quality and availability of Mercedes-Benz mbrace® is guaranteed
- keep your multimedia system and communication module up-to-date

Further information about software updates can be found at <http://me.mercedes-benz.com>

### Performing a software update

#### Requirements

- An Internet connection is required for updates which are obtained online .

Multimedia system:

↳ System ▶▶ Software Update

#### Automatically

Requirements

- Your vehicle has a built-in communication module.

- ▶ Activate [Automatic Online Update](#) . Updates are performed.

The current status of the updates is displayed.

#### Manually

- ▶ Deactivate [Automatic Online Update](#) .
- ▶ Select an update from the list and start the update.

#### Searching for new Updates

Requirements

- Your vehicle does not have a built-in communication module.
- An Internet-enabled mobile phone is connected to the multimedia system (→ page 271).

- ▶ Select [Search for New Updates](#). The list of available updates is refreshed.
- ▶ Select an update and start the update. The selected update is downloaded via the connected mobile phone.

#### Activating the software update

- ▶ Restart the system.

#### Important system updates

Important system updates may be necessary for the security of your multimedia system's data. Please install these updates, or else the security of your multimedia system cannot be ensured.

- ⓘ If automatic software updates are activated, the system updates will be downloaded automatically (→ page 241).

As soon as an update is available for download, a corresponding message appears on the multimedia system display.

You have the following selection options:

- [Download](#)  
The update will be downloaded in the background.
- [Details](#)  
Information about the pending system update is displayed.
- [Later](#)  
The update can be downloaded manually at a later time (→ page 241).

If the download is completed and the update is ready for installation, you will be informed of this after the next ignition cycle, for example.

Requirements for the installation:

- The ignition is switched off.
- Notes and warnings have been read and accepted.
- The electric parking brake is applied.

If all requirements are met, the update will be installed. The multimedia system cannot be operated while the update is being installed and vehicle functions are restricted.

If errors should occur during the installation, the multimedia system automatically attempts to restore the previous version. If restoration of the previous version is not possible, a symbol

appears on the center console display. Please consult a qualified specialist workshop to resolve the problem.

### Reset function

Multimedia system:

↳ System ▶▶ Reset

Personal data is deleted, for example:

- station presets
- connected mobile phones

▶ Select **Yes**.

If PIN protection is activated, a prompt appears asking if you also wish to restore this to the factory settings during a reset.

- ▶ Select **Yes**
- ▶ Enter the current PIN.  
The PIN is reset.

Or

- ▶ Select **No**.  
The current PIN stays the same after resetting.

ⓘ If you have forgotten your PIN, an authorized Mercedes-Benz Center can deactivate your PIN protection for you.

A prompt appears again asking whether you really wish to reset.

- ▶ Select **Yes**.  
The multimedia system is reset to the factory settings.

**ENERGIZING comfort****ENERGIZING comfort program overview****Program overview**

<b>Programs</b>	<b>Function</b>
<b>Refresh</b>	Can make targeted changes to the interior climate to refresh vehicle occupants. Cooling airflow and ionization purify the air. The vehicle interior is illuminated with cool colors and the seats are ventilated.
<b>Warmth</b>	Can increase the comfort level of the occupants. The vehicle's panel, seat and steering wheel heater produce a cozy warmth. The air is purified using ionization and a pleasant fragrance is released. The vehicle interior is illuminated with warm lighting.
<b>Vitality</b>	Can counteract fatigue in monotonous driving situations. Fast-paced music and a vitalizing massage provide invigorating stimulation for the vehicle occupants. The air is purified using ionization and a pleasant fragrance is released. The vehicle interior is illuminated in a stimulating hue and the seat is ventilated.
<b>Pleasure</b>	Can promote a positive mood in the occupants. Moderately fast music is played and a massage program is activated. The air is purified using ionization and a pleasant fragrance is released. The vehicle interior is illuminated with amicable lighting.

Programs	Function
<b>Well being</b>	Can aid the physical and mental relaxation of occupants. A back massage combined with local warmth provide relaxation. The air is purified using ionization and a pleasant fragrance is released. The music player plays selections of calming music and the vehicle interior is illuminated with pleasant lighting.
<b>Training</b>	Can counteract the onset of muscle tension, limbs falling asleep or stress with targeted relaxation or stimulation exercises. The exercises are demonstrated in short videos. The air is purified using ionization and a pleasant fragrance is released. The vehicle interior is illuminated with lighting appropriate to the exercise.

-  Please note that the available programs and the associated functions are dependent on your vehicle equipment. Depending on your equipment, fewer functions may be available.

### Starting the ENERGIZING comfort program

#### Requirements:

- The ignition is switched on.
-  ENERGIZING comfort is available approximately five minutes after starting the multimedia system.

Multimedia system:

- ➔ **Vehicle** ➔ **ENERGIZING Comfort**
- ▶ Select **Refresh, Warmth, Vitality, Enjoyment** or **Well-being**.

The selected program will run for ten minutes.

#### Starting training

- ▶ Select **Training**.
- ▶ Select **Muscle Relaxation, Muscle Stimulation** or **Balance**.  
The selected training video starts and is displayed in the media display.

- ▶ Select **Full Screen: Video**.  
The training video is displayed in full screen.

-  For information about pausing or skipping videos, see Media playback (→ page 296).

If, during an active program, a function requirement is no longer met, a corresponding message appears. The active program is canceled.

## Navigation

### Switching navigation on

Multimedia system:

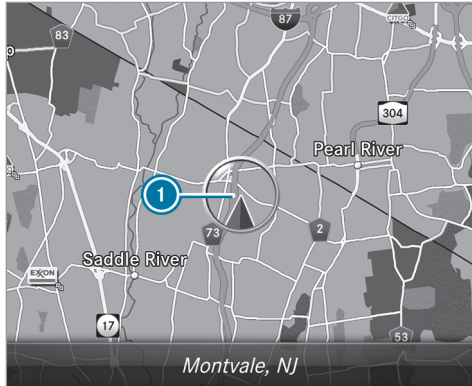

- ▶ Alternatively: press the **NAVI** button. The map appears and shows current vehicle position ①.

- ① If a climate control setting is changed, a climate bar appears briefly.

### Showing/hiding the navigation menu

#### Requirements

- The map shows the vehicle's current position.

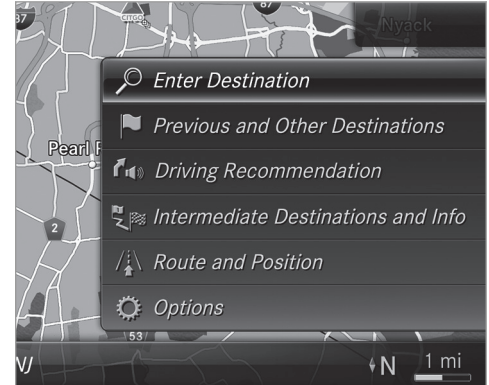

- ▶ **To show:** swipe left on the touchpad or the Touch Control.

or

- ▶ Slide the controller to the left.
- ▶ **To hide:** swipe right on the touchpad or the Touch Control.

or

▶ Slide the controller to the right.

- ① To show or hide lower menu levels, swipe or slide to the left or right as many times as necessary.

## Destination entry

### Entering a POI or address

Multimedia system:

Navigation

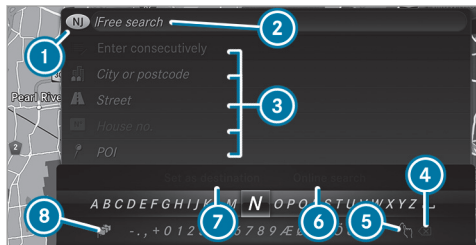

▶ Show the navigation menu.

▶ Select Enter Destination.

The state or province in which the vehicle is located is set ①.

There are two available methods of destination entry:

- free search ②
- step-by-step search ③

### Method 1: free search

▶ Enter the POI or address in ②. The entries can be made in any order. During destination entry, suggestions are made by the multimedia system. A selection of destinations appears in a list.

Enter these address elements, for example:

- city, street, house number
- street, city
- ZIP code
- POI name
- POI category, e.g. Gas Station
- city, POI name

▶ **To switch to handwriting recognition:** select ⑤ .

▶ Write the character on the touchpad.

▶ **To switch to character selection:** press the button.

or

▶ Press the touchpad.

▶ **To delete an entry:** select ④ (if available).

- Press briefly: deletes the last character entered or the last suggestion adopted.
- Press and hold: deletes the entire entry.

▶ **To set the language:** select ⑥.

▶ Select the language.

① This function is useful for countries in which several character sets are supported. An example is Russia, which uses Cyrillic and Latin characters.

▶ **To call up the online search function:** select ⑥ [Online Search](#).

Once an Internet connection is established, a list appears. It shows online destinations related to the previous entry.

Online destinations are provided by the Internet service provider.



▶ Select the online destination.  
or

▶ Enter an online destination in the input line.

❗ Online search is not available in all countries.

❗ Requirement (USA): Mercedes-Benz mbrace® is activated.

▶ **To call up the list:** press the  button.  
or

▶ If the top line of the character bar is highlighted, navigate upwards.

▶ Select the destination in the list.

▶ **To adopt a destination:** select **Select Destination** .

If there are several listings for a destination, a list appears.

▶ Select the destination.  
The destination address is shown.

### Method 2: search step-by-step

▶ Press the  button.  
or

▶ If the top line of the character bar is highlighted, navigate upwards.

The character bar is hidden. **City or ZIP** is highlighted. Additional entry fields, e.g. for **POI**, are available.

▶ Select **City or ZIP**.  
The character bar appears.

▶ Enter the city or the ZIP code.  
During destination entry, suggestions are made by the multimedia system. A selection of destinations appears in a list.

The address entries can be made in any order, for example:

- **City or ZIP, Street, House No.**  
Enter an intersecting street, if available.
- **Street, City or ZIP**
- **POI, e.g. Gas Station, City or ZIP**

❗ During destination entry, use the following functions:

- switching to handwriting recognition
- switching to character selection
- deleting an entry

An entry, e.g. **POI**, can be deleted with  in a step-by-step search. Navigate to the left to do so.

- call up online search function (if available)
- calls up a list

The functions are described in the free search.

▶ **To change the state/province:** select the state or the province.

▶ Enter the state or the province. You only need to enter the first character.

▶ Select the state or the province in the list.

▶ **To change the country:** select the country.

▶ Enter the country. You only need to enter the first character.

▶ Select the country on the list.

▶ **To adopt a destination:** select **Select Destination**.

If there are several listings for a destination, a distance-orientated list appears.

- ▶ Select the destination.  
The destination address is shown.

### Selecting previous destinations

Multimedia system:

↳ [Navigation](#) ▶ [Previous and Other Destinations](#)

- ▶ Select [Previous Destinations](#).
- ▶ Select the destination suggestion or the destination.  
The destination address is shown.
- ⓘ If [Learn Journeys](#) is switched on , destination suggestions are displayed (→ page 260).
- ▶ **Alternatively:** if a favorite has been saved (→ page 259), select [From Global Favorites](#).
- ▶ Select the favorite.  
The destination address is shown.

### Selecting a POI

Multimedia system:

↳ [Navigation](#) ▶ [Previous and Other Destinations](#) ▶ [POIs](#)

#### Method 1

- ▶ Select the category.  
If route guidance is not active: the search begins in the vicinity of the current vehicle position. The list is sorted by distance in ascending order.  
If route guidance is active: the search begins after selecting a search position.  
The POIs show the following information:
  - name of POI
  - linear distance to the POI
  - the direction of the linear distance to the POI (arrow) is displayed when searching for the vehicle's current position
- ▶ Select the POI.
- ▶ **Route guidance is active:** select the search position prior to choosing a POI.

- ▶ If intermediate destinations are set, these can also be selected as the search position after selecting [Near Destination](#).

#### Method 2

- ▶ Select [All Categories](#).
- ▶ Select the category.
- ▶ Select the POI.
- ▶ **Route guidance is active:** select the search position prior to choosing a POI.
- ▶ If intermediate destinations are set, these can also be selected as the search position after selecting [Near Destination](#).

#### Alternatively filtering the display by POI

- ▶ Enter a search term in the  [Search:](#) line.  
The results list shows relevant POIs.
- ▶ Select .
- ▶ The first POI in the list is highlighted.
- ▶ Select the POI.

### Example: setting the search position for the parking category during active route guidance

- ▶ Select **In the Vicinity, Near Destination or Along the Route**.  
The list shows the located POIs or opens an overview of the route destination after selecting **Near Destination**.
- ▶ Select the POI.
- ▶ Select **Near Destination**: select the intermediate destination or the destination.

### Starting an automatic gas station search

#### Requirements:

- The automatic gas station search is activated  
 (→ page 254).

#### Driving situation

Route guidance is active. The fuel level in the fuel tank reaches the fuel reserve.

The **Reserve Fuel Would you like to start a search for surrounding gas stations?** message is shown.

- ▶ Select **Yes**.  
The automatic gas station search begins. The available gas stations along the route or in the vicinity of the vehicle's current position are displayed.
- ▶ Select the gas station.  
The address of the gas station is displayed.
- ▶ If route guidance is not active, select **Start Route Guidance**.  
The selected gas station is set as the destination. Route guidance begins.

or

- ▶ If route guidance is active, select **Start New Route Guidance** or **Set as Next Intermediate Destination**.  
**Start New Route Guidance**: the selected gas station is set as a new destination. The previous destinations and intermediate destinations are deleted. Route guidance to the gas station begins.  
**Set as Next Intermediate Destination**: the selected gas station is set as the next intermediate destination. Route guidance begins.

- ▶ **If there are already four intermediate destinations**: select **Yes** in the prompt.  
The selected gas station is entered into position 1 of the intermediate destinations menu. Intermediate destination 4 is deleted. Route guidance begins.

### Entering an intermediate destination

#### Requirements

- A destination is entered.

Multimedia system:

↳ **Navigation** ▶ **Intermediate Destinations and Info**

- ▶ Select **Search for an Intermediate Destination**.
- ▶ Enter the intermediate destination as a POI or address (→ page 246).
- ▶ Select the intermediate destination.
- ▶ Select **Set as Destination**.

or

- ▶ Select an intermediate destination using  [Enter Destination](#) during route guidance.
- ▶ Select [Set as Next Intermediate Destination](#) after entering the destination.



### Editing intermediate destinations

#### Requirements:

- A destination is entered.

Multimedia system:

 [Navigation](#) ▶ [Way Points and Info](#)

- ▶ **To change the order of destinations:** highlight the destination or the intermediate destination.
- ▶ Select  [Move](#).
- ▶ Move the intermediate destination to the desired position.
- ▶ Press the Touch Control, the controller or the touchpad.
- ▶ **To call up the map:** highlight the destination or the intermediate destination.
- ▶ Select  [Map](#) .

- ▶ Move the map (→ page 264).
- ▶ Select destination on the map (→ page 251).
- ▶ **To delete a destination:** highlight the destination or the intermediate destination.
- ▶ Select  [Delete](#) .

### Calculating a route with intermediate destinations

#### Requirements

- The destination and at least one intermediate destination have been entered.

Multimedia system:

 [Navigation](#) ▶ [Intermediate Destinations and Info](#)

- ▶ Select [Start New Route Guidance](#).  
The route is calculated with the set intermediate destinations.

### Selecting a contact

#### Requirements

- a mobile phone is connected to the multimedia system (→ page 271).

Multimedia system:

 [Navigation](#) ▶ [Previous and Other Destinations](#) ▶ [Contacts](#)

- ▶ Select the contact.  
The contact details are displayed.
- ▶ Select the address.

### Alternatively filtering the display by contacts

- ▶ Enter a name or telephone number, for example, into the search field.
- ▶ Select .  
The first contact in the list is highlighted.
- ▶ Select the contact.
- ▶ Select the address.

### Entering geo-coordinates

Multimedia system:

 [Navigation](#) ▶ [Previous and Other Destinations](#) ▶ [Geo-coordinates](#)

- ▶ Enter geo-coordinates as latitude and longitude coordinates in degrees, minutes and seconds.  
The map shows the position.

- ▶ Confirm the entry.
- ▶ **To calculate a route:** select [Start Route Guidance](#).
- ▶ If a route has already been created, select [Start New Route Guidance](#) or [Set as Intermediate Destination](#).

### Selecting from the map

Multimedia system:

Navigation ▶ Options ▶ Map Menu

- ▶ **Alternatively:** if the map is displayed in full screen mode, press the Touch Control, the controller or the touchpad. The map menu appears.
- ▶ Select "move map" in map menu ② (→ page 263).
- ▶ Swipe in any direction on the Touch Control or touchpad.

or

- ▶ Slide the controller in any direction. The map moves in the corresponding direction under the crosshair. The more you move

- ▶ your finger away from the starting position on the touchpad, the faster the map moves.
- ▶ Press the Touch Control, the controller or the touchpad. If several destinations are located around the crosshair, a list shows the available POIs and roads.
- ▶ If a destination is located exactly on the crosshair, the destination address is displayed.
- ▶ Select the destination in the list. The destination address is shown.

### Setting the map orientation to 2D or 3D

- ▶ Highlight [Map Orientation: 2D/3D](#).
- ▶ Press the Touch Control, the touchpad or the controller. The map will be displayed in the selected map orientation.

### Showing traffic messages in the vicinity of the map

- ▶ Select [Traffic Messages for the Vicinity](#). The map appears.
- ▶ Swipe left or right on the touchpad.

or

- ▶ Slide the controller to the left or right. The previous or next traffic incident is highlighted on the map. Information on the traffic incident is displayed.

### Showing POIs in the vicinity of the map

- ▶ Select [POIs in the Vicinity](#).
- ▶ Swipe left or right on the touchpad.

or

- ▶ Slide the controller to the left or right. The previous or next POI is highlighted on the map. The name or the address is shown.
- ▶ **Alternatively, to filter the display by POI category:** swipe down on the Touch Control or the touchpad.

or

- ▶ Slide the controller down.
- ▶ Select the POI category.

- ① [User Defined](#) allows personal POI symbols to be selected (→ page 265).

## Route

### Calculating a route

#### Requirements:

- The destination has been entered.
- The destination address is shown.

- ▶ If route guidance is not active, select [Start Route Guidance](#).  
The route to the destination is calculated. The map shows the route. Route guidance then begins.





or

- ▶ If route guidance is active, select [Start New Route Guidance](#) or [Set as Next Intermediate Destination](#).  
**Start New Route Guidance:** the selected destination address is set as a new destination. The previous destinations and intermediate destinations are deleted. Route guidance to the new destination begins.  
**Set as Next Intermediate Destination:** the selected destination address is set as the next intermediate destination. Route guidance begins.

### Taking alternative routes into consideration

- ▶ Select an alternative route (→ page 254).

### Other menu functions

- ▶ **To save the destination:** select  [Store](#) in "Previous Destinations".
- ▶ **To display on the map:** select  [Map](#).
- ▶ **To call a telephone number:** select  [Call](#).
- ▶ **To call up an Internet address:** select  [www](#) (if available).

### Selecting a route type

Multimedia system:

 [Navigation](#) ▶  [Route and Position](#)

- ▶ Select [Route Settings](#).
- ▶ Select the route type.  
A route has already been created: the route is calculated on the basis of the new route type.  
A route has not been created: the next route is calculated on the basis of the new route type.

- [Eco Route](#)

An economical route is calculated. The journey time may be somewhat longer than for quicker routes.

The symbol for the current vehicle position is displayed in green.

- [Fast Route](#)

A route with a quick journey time is calculated.

- [Short Route](#)

A route with a short driving distance is calculated.

[Automatic Traffic Jam Avoidance](#) can be switched on  or off  for these route types. If [Automatic Traffic Jam Avoidance](#) is switched on, [Ask in the Event of Traffic Jam Avoidance](#) can be selected.

The route types [Automatic Traffic Jam Avoidance](#) and [Ask in the Event of Traffic Jam Avoidance](#) are not available in every country.

- [Automatic Traffic Jam Avoidance](#)

The route is calculated with the currently set route type.

Traffic reports via Live Traffic Information are taken into account.

Live Traffic Information is not available in all countries.

- **Ask in the Event of Traffic Jam Avoidance**

A prompt appears when a new route is detected with a shorter journey time based on traffic reports. You can continue to use the current route or use the dynamic route instead.

### Selecting route options

Multimedia system:

Navigation  **Navigation**  **Route and Position**  **Avoid Options**

### Avoiding areas

▶ Select **Areas** (→ page 266).

### Avoiding motorways, ferries, motorail trains, tunnels, unpaved roads

▶ Select  or deselect  avoid option.

### Using toll roads

- ▶ Select **Use Toll Roads**.
- ▶ Select **Cash** or **Electronic Billing** or **Off**. The route takes into account roads that require the payment of a usage fee (toll). If **Off** is selected, toll roads are not taken into account.

The selected route options cannot always be implemented. Therefore, a route may include a ferry, for instance, even though the avoid **Ferries** option is enabled. A message appears and you will hear a corresponding message.

### Using carpool lanes

- ▶ Select **Number of Occupants in the Vehicle**.
- ▶ Select number. When using carpool lanes, observe the applicable legal requirements as well as any conditions pertaining to when and where such lanes may be used. Carpool lanes may only be used if certain conditions are met.

These route options are not available in every country.

### Selecting notifications

Multimedia system:

Navigation  **Navigation**  **Options**  **Announcements**

- ▶ Switch announcements on  or off .
  - **Announce Traffic Warnings**  
The function is not available in all countries.
  - **Announce Street Names**  
The multimedia system announces the names of the roads that will follow the upcoming change of direction.  
This function is not available in all countries and languages.

### Displaying destination information

#### Requirements:

- A destination is entered.

Multimedia system:

→ Navigation

- ▶ Select **Intermediate Destinations and Info.**

The following information is displayed:

- intermediate destinations and destination  
The route can also include up to four intermediate destinations.
- name, address
- remaining driving distance
- time of arrival

### Selecting an alternative route

Multimedia system:

→ Navigation ▶  Route and Position

- ▶ Select **Alternative Route.**  
The routes are displayed in accordance with the setting made in the route settings.  
The currently selected route is shown with a dark blue line.
- ▶ Select the alternative route.

### Switching the automatic gas station search on/off

Multimedia system:

→ Navigation ▶  Options

- ▶ Switch **Reserve Fuel** on  or off .  
Switched on : when the fuel reserve level is reached, a prompt appears asking whether you want to start searching for gas stations.

### Starting the automatic service station search

#### Requirements:

- ATTENTION ASSIST and the **Suggest Rest Area** function are activated (→ page 190).

#### Driving situation

The **Attention Assist Do you want to search for a rest area?** message is shown.

- ▶ Select **Yes.**  
The service station search starts. The available service stations along the route or in the vicinity of the vehicle's current position are displayed.
- ▶ Select the service station.  
The service station address is displayed.

- ▶ If route guidance is not active, select **Start Route Guidance.**

The selected service station is set as a destination. Route guidance begins.

or

- ▶ If route guidance is active, select **Start New Route Guidance** or **Set as Next Intermediate Destination.**

**Start New Route Guidance:** the selected service station is set as a new destination. The previous destination and all intermediate destinations are deleted. Route guidance to the service station begins.

**Set as Next Intermediate Destination:** the selected service station is set as the next intermediate destination. Route guidance begins.



## Route guidance

### Notes on route guidance

**⚠ WARNING** Risk of distraction from operating integrated communication equipment while the vehicle is in motion

If you operate communication equipment integrated in the vehicle when driving, you will be distracted from the traffic situation. This could also cause you to lose control of the vehicle.

- ▶ Only operate this equipment when the traffic situation permits.
- ▶ If you cannot be sure of this, stop the vehicle whilst paying attention to road and traffic conditions and operate the equipment with the vehicle stationary.

Route guidance begins once a route has been calculated.

The road and traffic rules and regulations always have priority over multimedia system driving recommendations.

Driving recommendations are:

- Navigation announcements
- Route guidance displays
- Lane recommendations

If you do not follow the navigation announcements or if you leave the calculated route, a new route is calculated automatically.

Driving recommendations may differ from the actual road and traffic conditions if:

- the route is diverted.
- the direction of a one-way street has been changed.

For this reason, you must always observe road and traffic rules and regulations during your journey.

The route may differ from the ideal route due to the following:

- roadworks
- incomplete digital map data

## Changing direction overview

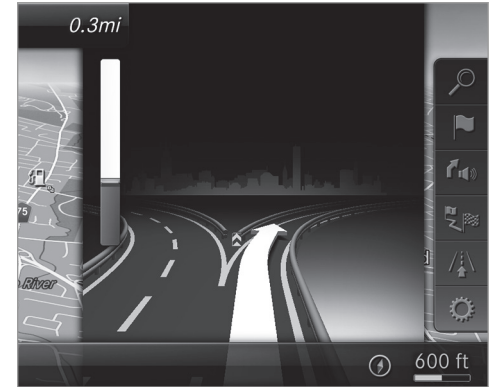

There are three phases when changing direction:

- Preparation phase

If there is enough time between the changes of direction, the multimedia system prepares you for the upcoming change of direction. A navigation announcement, e.g. "Prepare to turn right", is issued.

The map appears in full-screen mode.

- Announcement phase

The multimedia system announces the upcoming change of direction, e.g. by announcing "Turn right in 300 feet (100 m)".

The display is split into two parts. The map is displayed on the left; on the right, there is a detailed image of the junction or a 3D image of the upcoming change of direction.

- Change-of-direction phase

The multimedia system announces the imminent change of direction, e.g. by announcing "Now turn right".

The display is split into two parts.

The vehicle has successfully changed direction when the light-colored bar on the right drops down to 0 feet (0 meters) and the current vehicle position symbol has reached the highlighted change-of-direction point.

When the change of direction is complete, the map appears in full-screen mode.

- ① Changes of direction are also shown in the Instrument Display.

### Lane recommendations overview

This display appears for multi-lane roads.

If the digital map contains the relevant data, the multimedia system can display lane recommendations for the next two changes of direction.



- ① Recommended lane
- ② Possible lane
- ③ Lanes not recommended

- Recommended lane ①

In this lane, you will be able to complete both the next change of direction and the one after that.

- Possible lane ②

In this lane, you will only be able to complete the next change of direction.

- Lane not recommended ③

In this lane, you will not be able to complete the next change of direction without changing lane.

During the change of direction, new lanes may be added.

- ① Lane recommendations can also be displayed in the Instrument Display and in the Head-up Display.

### Destination reached

Once the destination is reached, you will see the checkered flag [🚩]. Route guidance is finished.

When an intermediate destination has been reached, you will see the intermediate destination flag with the number of your intermediate

destination . After this, route guidance is continued.

### Switching navigation announcements on/off

#### Requirements:



- a route has already been created.
- route guidance is active.

▶ **To switch off:** press the  button on the multifunction steering wheel during a navigation announcement.

or

▶ Press on the volume control to the right of the controller during a navigation announcement (→ page 228).  
The **Voice Guidance has been deactivated.** message appears.

or

▶ Show the navigation menu (→ page 245).  
▶ Select  **Voice Guidance.**  
The symbol changes to .  
▶ **To activate:** select  **Voice Guidance.**  
The current navigation announcement is played.

ⓘ In the following situations, navigation announcements are switched on automatically:

- A new route guidance is started.
- The route is recalculated.

ⓘ You can access and add this function as a favorite under **Voice Guidance On/Off.**

### Switching navigation announcements on/off during a phone call



▶ Select **System.**  
▶ Select  **Audio .**  
▶ Select **Navigation and Traffic Announcements.**  
▶ Switch **Voice Guidance During Call** on  or off .

### Adjusting the volume of navigation announcements

#### Requirements:

- a route has already been created.
- route guidance is active.

### On the multifunction steering wheel or on the multimedia system

▶ Press the  or  button on the multifunction steering wheel during a navigation announcement.

or

▶ Turn the volume control to the right of the controller during a navigation announcement (→ page 229).

ⓘ In the following situations, the volume is raised to the minimum volume or lowered to the maximum volume:

- A new route guidance is started.
- The route is recalculated.

ⓘ The minimum volume can be individually set at an authorized Mercedes-Benz Center.

### Via system settings

▶ Select **System.**  
▶ Select  **Audio .**  
▶ Select **Navigation and Traffic Announcements.**  
▶ Select **Voice Guidance Volume.**

- ▶ Set the volume.

### Switching audio fadeout on/off during navigation announcements

- ▶ Select **System**.
- ▶ Select  **Audio**.
- ▶ Select **Navigation and Traffic Announcements**.
- ▶ Switch **Audio Fadeout During Voice Guidance** on  or off .



### Repeating navigation announcements

#### Requirements:

- a route has already been created.
- route guidance is active.

Multimedia system:

 **Navigation**

- ▶ Select  **Driving Recommendation**.
- ▶ Select  **Driving Recommendation**.  
The current navigation announcement is repeated.

- ① You can access and add this function as a favorite under **Repeat Spoken Driving Recommendation**.

### Canceling route guidance

#### Requirements:

- a route has already been created.
- route guidance is active.

Multimedia system:

 **Navigation**

- ▶ Select **Cancel Route Guidance**.

### Resuming route guidance

#### Requirements:

- A route has already been created
- Route guidance is interrupted

- ① If the journey was interrupted for less than 2 hours, route guidance continues automatically.

Multimedia system:

 **Navigation** ▶  **Destination**

- ▶ Select **Continue Route Guidance**.  
The route is recalculated.

### Route guidance to an off-road destination

Off-road destination: the destination is within the digital map. However, the map contains no roads that lead to the destination.

You can enter off-road destinations on the map. Route guidance guides you for as long as possible with navigation announcements and displays on roads that are known to the multimedia system.

Shortly before you reach the last known position on the map, you will hear the "Please follow the direction arrow" announcement. The display shows a direction arrow and the linear distance to the destination.

### Route guidance from an off-road location to a destination

Off-road position: the current vehicle position is located within the digital map on roads that are not available.

The following displays appear when route guidance begins:

- the **Road Not Mapped** message
- a direction arrow showing the linear direction to the POI

When the vehicle is back on a road known to the multimedia system, route guidance continues as normal.

### Notes on the off-road status during route guidance

Due to roadworks, for example, there may be differences between the data on the digital map and the actual course of the road. In such cases, the multimedia system will temporarily be unable to locate the vehicle's current position on the digital map. The vehicle is off-road.

The following displays appear when the vehicle is off-road:

- the **Road Not Mapped** message
- a direction arrow showing the linear direction to the POI

When the vehicle is back on a road known to the multimedia system, route guidance continues as normal.

## Destination

### Saving the current vehicle position

Multimedia system:

↳ **Navigation**

- ▶ If the map is displayed in full screen mode, press the central control element. The map menu appears.
- ▶ Select **1** on the map menu (→ page 263). The current vehicle position is saved to the "Previous destinations" memory.

### Storing a map position

Multimedia system:

↳ **Navigation**

The map is in full-screen mode.



- ▶ Press the Touch Control, the controller or the touchpad.
- ▶ Select "move map" in map menu **2** (→ page 263).



- ▶ Select a position on the map. If multiple entries are available for a map position, a list appears.
- ▶ Highlight an entry.
- ▶ Select  **Store in "Previous Destinations"**. The map position is saved to the "Previous destinations" memory.

### Editing the previous destinations

Multimedia system:

↳ **Navigation** ▶  **Previous and Other Destinations** ▶ **Previous Destinations**

- ▶ Highlight one of the previous destinations.
- ▶ **To save as a favorite:** select  **Save as Global Favorite**. The favorites are displayed.
- ▶ Move the favorite to the desired position. If a favorite has already been added at this position, it will be overwritten.
- ▶ **To save as "Home" address:** select  **Save as "Home"**.

- ▶ **To save as "Work" address:** select  **Save as "Work"**.
- ▶ **To delete a single or all destinations:** select  **Delete** or **Delete All**. A prompt appears.
- ▶ Select **Yes**.
- ▶ **To display destination information:** select  **Details**.

### Using intelligent destination suggestions

Multimedia system:

 **Navigation** ▶  **Options** ▶ **Intelligent Destination Suggestions**

The navigation system learns the user habits of the driver. The most probable destinations are suggested.

- ▶ Activate **Allow destination suggestions** . The vehicle can provide destination suggestions based on navigation destinations that have been visited.  
If the function has been activated, destination suggestions are shown in previous desti-

nations and can be selected for route guidance.

- ▶ Select **Accept** or **Reject**.  
**Accept** allows data acquisition and changes to the last display.  
**Reject** rejects data acquisition and deactivates the function.
- ▶ **To deactivate the function:** deactivate **Allow destination suggestions** .
- ▶ **To delete destination suggestions:** select **Reset history**.

### Using external destinations and routes

External destinations and routes can be received from the following sources:

- Mercedes-Benz Apps
- Door-to-door navigation with Companion App (USA)
- Via an MB Info call to the Mercedes-Benz Customer Assistance Center

A prompt appears on the media display. Received destinations and routes are saved in the previous destinations.

- ▶ **If a destination is received:** select **Yes** and continue with method 1 or 2.

or

- ▶ If a destination was received with photo information, select **Start Route Guidance**. Route guidance starts.
- ▶ Method 1: if route guidance is not activated, select **Start Route Guidance**. The route to the destination is calculated. The map shows the route. Route guidance then begins.
- ▶ Method 2: if route guidance is active, select **Start New Route Guidance** or **Set as Next Intermediate Destination**.  
**Start New Route Guidance:** the received destination address is set as a new destination. The previous destinations and intermediate destinations are deleted. Route guidance to the new destination begins.  
**Set as Next Intermediate Destination:** the received destination address is set as the next new intermediate destination. Route guidance begins.

- ▶ **A route has been received:** select [Start Route Guidance from Beginning of Route](#) or [Start Route Guidance from Current Position](#). Route guidance starts from the selected position.

### [Route guidance with current traffic reports](#)

#### Traffic information overview

Traffic reports are received using Live Traffic Information and are used for route guidance.

This service is unavailable in some countries.

- ⓘ There may be differences between the traffic reports received and the actual road and traffic conditions.

Important information on Live Traffic Information:

- Current traffic reports are received via the Internet connection.
- The traffic situation is updated at short, regular intervals.
- The status of the service subscription can be displayed (→ page 261).

Information on the vehicle's position is regularly sent to Daimler AG. The data is immediately rendered anonymous by Daimler AG and forwarded to the traffic data provider. Using this data, traffic reports relevant to the vehicle's position are sent to the vehicle. The vehicle acts as a sensor for the flow of traffic and helps to improve the quality of the traffic reports.

If you do not wish to transmit your vehicle position, you can have this service deactivated at an authorized Mercedes-Benz Center.

#### Displaying subscription information

##### Requirements:

- The vehicle is equipped with Live Traffic Information.

Multimedia system:

↳ [Navigation](#) ▶  [Options](#)

The subscription expiry date is automatically displayed:

- one month before the expiry date
- one week before the expiry date
- on the expiry date

- ▶ **To display manually:** select [Live Traffic Subscription Info](#).

Depending on the status, one of the following messages appears:

- the period of validity for the subscription is displayed.
- the subscription has expired.
- ⓘ The subscription can be extended:
  - at an authorized Mercedes-Benz Center
  - via an MB Info call to the Mercedes-Benz Customer Assistance Center

#### Displaying the traffic map

##### Requirements:

- For Live Traffic Information: the vehicle is equipped with a communication module featuring an activated, integrated SIM card.
- When the vehicle is started, the communication module automatically establishes an Internet connection. Traffic information is made available shortly afterwards.

Multimedia system:

Navigation ► Options ► Map Menu

▶ Alternatively: if the map is displayed in full screen mode, press the Touch Control, the controller or the touchpad. The map menu appears.

▶ Activate  .

The traffic map shows the following information, for example:

- traffic incidents, for example:
  - roadworks
  - road blocks
  - warning messages

The symbols for traffic incidents are displayed in color (on the route) or gray (off the route).

- traffic flow information:
  - traffic jam (red line)
  - congested traffic conditions (orange line)
  - slow-moving traffic (yellow line)

- free-flowing traffic (green line)
  - display for traffic delays on the route lasting at least one minute
  - warning message symbols:
    - symbol 
    - additional road safety notes when approaching a traffic incident, e.g. the end of a traffic jam
- If the vehicle approaches a danger area on the route, a warning message is displayed on the map. A warning message may also be issued (→ page 263).

### Displaying traffic incidents

Multimedia system:

Navigation ► Options ► Map Content

▶ Activate  **Traffic Incidents**. Roadworks, road blocks, local area reports (e.g. fog) and warning messages are displayed.

### Activating free flow and traffic display

▶ Activate  **Free Flowing Traffic** and **Traffic Delays**.

ⓘ The traffic delay is displayed for the current route. Traffic delays lasting one minute or longer are taken into consideration.

### Displaying details

▶ Displaying the traffic map (→ page 261).

▶ Moving the map (→ page 264).

▶ When a traffic report symbol is under the crosshair, press the Touch Control, the controller or the touchpad. The traffic report details are displayed.

or

▶ Press the Touch Control, the controller or the touchpad.

▶ Select **Information on Traffic Reports**.

The map shows the traffic report symbols in the vicinity.

Traffic report information is displayed in the status line:

- traffic report symbol



- reason for the traffic report, e.g. traffic jam
- warning message (highlighted in red)

▶ **To select a traffic report symbol:** select **Next** or **Previous**.

▶ Press the Touch Control, the controller or the touchpad.  
The traffic report details are displayed.

### Issuing hazard alerts

Multimedia system:

→ **Navigation**

▶ ▶ **Options** ▶ **Announcements**

▶ Activate  **Announce Traffic Warnings**.  
Warning messages are issued and tailbacks which pose a risk are announced.

## Map and compass

### Map and compass overview

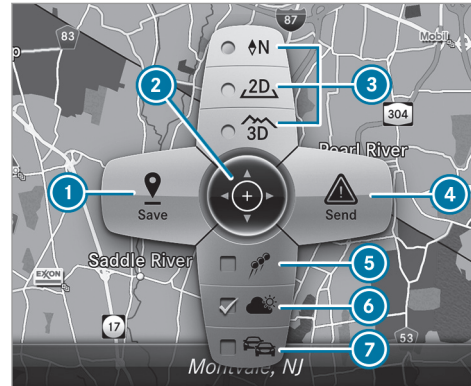

- ① Saves the current vehicle position
- ② Moves the map
- ③ Selects the map orientation and map view
- ④ Selects the function depending on the equipment:
  - To transmit a hazard alert (Car-to-X)

• To filter the display of POIs in the vicinity according to POI category

- ⑤ Switches the display of personal POI symbols on the map on or off
- ⑥ Switches one of the following displays on or off depending on the equipment:
  - Weather information
  - Satellite map
  - Traffic incidents
- ⑦ Switches the traffic map display on or off

The map and satellite images are shown in globe projection. This allows for a realistic map display in all map scales. The map uses elevation modeling.

Depending on the map data, important buildings in many cities are depicted realistically on the map in small map scales (1/32 mi (20 m), 1/16 mi (50 m)). Other buildings are shown as models.

- ⑧ You can set the unit of measurement of the map scale (→ page 237).

If online information is available, fuel prices and the availability of parking spaces in parking garages are displayed, for example.

- ❶ Online information is not available in all countries.
- ❷ Requirement (USA): Mercedes-Benz mbrace® is activated.

If **Display in COMAND** is activated in Traffic Sign Assist (→ page 192), speed limits and overtaking restrictions are displayed on the map.

- ❸ Company logos displayed on the map are trademarks of the respective companies and used solely for the purpose of indicating the locations of these companies. The use of such logos on the map does not indicate approval of, support of or advertising by these companies for the navigation system itself.

### Setting the map scale

#### Requirements:

- The map is shown.

Multimedia system:

↳ **Navigation**

- ▶ **To zoom in:** swipe down on the Touch Control.

or

- ▶ Turn the controller anti-clockwise.

or

- ▶ Move two fingers apart on the touchpad.

- ▶ **To zoom out:** swipe up on the Touch Control.

or

- ▶ Turn the controller clockwise.

or

- ▶ Move two fingers together on the touchpad.

- ❹ You can set the unit of measurement of the map scale (→ page 237).

### Moving the map

Multimedia system:

↳ **Navigation** ▶  **Options** ▶ **Map Menu**

- ▶ Alternatively: if the map is displayed in full screen mode, press the Touch Control, the controller or the touchpad. The map menu appears.

- ▶ Select "move map" in map menu ❷ (→ page 263).

- ▶ Swipe in any direction on the Touch Control or touchpad.

or

- ▶ Slide the controller in any direction. The map moves in the corresponding direction under the crosshair. The further you move your finger away from the starting position on the touchpad, the faster the map moves.

### Selecting the map orientation

Multimedia system:

Navigation  Options  Map Menu

- ▶ Alternatively: if the map is displayed in full screen mode, press the Touch Control or the touchpad. The map menu appears.
- ▶ In map menu , select **N**, **2D** or **3D** (→ page 263).
  - **N**: the 2D map view is displayed so that north is always at the top.
  - **2D**: the 2D map view is aligned to the direction of travel.
  - **3D**: the 3D map view is aligned to the direction of travel.

### Selecting POI symbols

Multimedia system:

Navigation  Options  Map Content

POIs include filling stations and hotels which can be displayed as symbols on the map, for example. Not all POIs are available everywhere.

- ▶ Select **POI Symbols**. The **•** dot indicates the current setting. **Standard** displays symbols of predefined categories on the map. **User Defined** allows you to personally select the symbols for the available categories. **None** switches the display off.
- ▶ Select a setting.
- ▶ **User Defined**: select categories. The POI symbols of the selected categories are displayed  or not displayed .

### Selecting text information

Multimedia system:

Navigation  Options  Text Information

- ▶ Select text information. **Current Street** shows the street you are currently driving on at the bottom of the display. When the map is moved, the following information appears under the crosshair:
  - street name
  - POI name

- area name

**Geo-coordinates** displays the following information:

- longitude and latitude
- elevation  
The elevation shown may deviate from the actual elevation.
- number of satellites from which a signal can be received  
When the map is moved, this information does not appear.

**Climate Control** displays the current climate control settings.

**None** switches the display off.

### Switching highway information on/off

Multimedia system:

Navigation  Options

- ▶ Switch **Highway Information** on  or off . The function is switched on : during a journey, additional information on upcoming facilities appears on the right side of the

screen. These include parking lots, service stations and highway exits, for example.

### Displaying the next intersecting street

#### Requirements:

- Route guidance is not active.

Multimedia system:

→ Navigation → ⚙ Options

- ▶ Activate  **Next Intersecting Street**.  
The name of the next intersecting street will be displayed at the upper edge of the display.

### Displaying traffic signs on the map

#### Requirement:

The vehicle is equipped with Traffic Sign Assist.

Multimedia system:

→ Navigation → ⚙ Options

- ▶ Activate  or deactivate  **Traffic Sign**.  
If the function is switched on  you will see the traffic signs recognized by Traffic Sign Assist.  
The following traffic signs are displayed:
  - Speed limitations

- Overtaking restrictions
- Traffic signs with a restriction indicated by an additional sign (e.g. in wet conditions)

### Displaying the map version

Multimedia system:

→ Navigation → ⚙ Options

- ▶ Select **Map Version**.
- ▶ Select **Details**.
- ⓘ Information about new versions of the digital map can be obtained from an authorized Mercedes-Benz Center.

### Avoiding an area

You can define areas along a route that you would like to avoid.

### Avoiding a new area

Multimedia system:

→ Navigation → ⚙ Route and Position → Avoid Options → Areas

- ▶ Select **Avoid New Area**.

- ▶ **To search for an area via the map:** select **Using Map**.

- ▶ Move the map

or

- ▶ **To search for an area using an address:** select **Address Entry**.

- ▶ Enter the address.

- ▶ Select **Select Destination**.

The map appears.

- ▶ **To display an area:** press the Touch Control, the touchpad or the controller.  
A red rectangle appears. This designates the area that should be avoided.

- ▶ **To change the size of the area:** swipe up or down on the Touch Control or the touchpad.

or

- ▶ Slide the controller up or down.  
The map scale is enlarged or reduced and changes the size of the area.

- ▶ **To set the area:** press the Touch Control, the touchpad or the controller.  
The area is entered into the list.

### Changing an area

Multimedia system:

Navigation ► Route and Position ► Avoid Options ► Areas

- Highlight an area in the list.
- Select  Edit.

### Moving the area on the map

- Swipe in any direction on the Touch Control or touchpad.

or

- Slide the controller in any direction.

### Changing the size of the area

- **To start:** press the Touch Control, the touchpad or the controller.

- **To change:** swipe up or down on the Touch Control or the touchpad.

or

- Slide the controller up or down.
- **To stop:** press the Touch Control, the touchpad or the controller.

### Taking the area for the route into account

- Avoid  an area in the list.  
If route guidance is active, a new route is calculated.

If there is no route yet, the setting is carried over to the next route guidance.



The route can include an area that is to be avoided in the following cases:

- the destination is located in an area that is to be avoided
- there is no sensible alternative route

### Deleting one or all areas

Multimedia system:

Navigation ► Route and Position ► Avoid Options ► Areas

- Highlight an area in the list.
- Select  Delete or  Delete All.
- Confirm the prompt with Yes.  
One or all areas are deleted.

### Map data update overview

#### Updating at the authorized Mercedes-Benz Center

The digital maps generated by the map software become outdated in the same way as conventional road maps. Optimal route guidance can only be provided by the navigation system in conjunction with the most up-to-date map data. Information about new versions of the digital map can be obtained from an authorized Mercedes-Benz Center.

You can receive updates to the digital map there.

#### Information on map data

Your vehicle is supplied with map data at the factory. Depending on the country, map data for your region is either pre-installed or the map data is supplied on a data storage medium. You do not require an activation code for the map data which is provided with your vehicle.

If the map data on your vehicle has been installed at the factory and you wish to reinstall it, you do not need to enter the activation code.

An activation code is required for purchased map data.

Observe the following notes:

- The activation code can be used for one vehicle
- The activation code is not transferable
- The activation code has six digits

In the event of the following problems, please contact an authorized Mercedes-Benz Center:

- The multimedia system does not accept the activation code
- You have lost the activation code

### Displaying the compass

Multimedia system:

→ Navigation →  Route and Position

▶ Select **Compass**.

The compass display shows the following information:

- the current direction of travel with bearing (360 degree format) and compass direction
- longitude and latitude coordinates in degrees, minutes and seconds

- height (rounded)
- number of GPS satellites from which a signal can be received

### Setting the map scale automatically

Multimedia system:

→ Navigation →  Options

The map scale is set automatically depending on your driving speed.

For journeys in cities with detailed city models, a map view from the driver's perspective is used.

▶ Switch **Auto Zoom** on  or off .

ⓘ The automatically selected map scale can be changed manually for a short time. The setting is reset automatically after a few seconds.

### Displaying the satellite map

Multimedia system:

→ Navigation →  Options → Map Content

▶ Switch **Satellite Map** on  or off .

or

▶ If satellite map display  is available in the map menu, switch it on  or off  (→ page 263).

Switched on : satellite maps are displayed in map scales of 2 mi (2 km).

Switched off : satellite maps are not displayed in map scales from 2 mi (2 km) to 10 mi (10 km).

ⓘ Satellite maps for these map scales are not available in all countries.

### Displaying weather information

Multimedia system:

→ Navigation →  Options → Map Content

▶ Activate  **Weather Information**.

or

▶ If weather information display  is available in the map menu, activate  (→ page 263) it.

Current weather information is displayed on the navigation map, e.g. temperature or cloud cover.

- ① Requirement (USA): Mercedes-Benz mbrace® is activated.
- ① Weather information is not available in all countries.

### Calling up the Digital Operator's Manual (navigation)

#### Calling up information on navigation

Multimedia system:

Navigation ► Options ► Navigation Info

► Select the topic.

## Telephone

### Telephony

#### Telephone menu overview

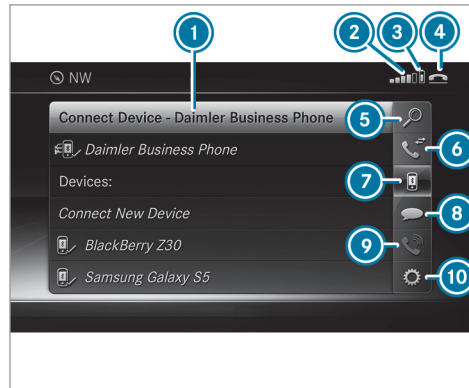

- ① Bluetooth® device name of the currently connected mobile phone
- ② Signal strength of the mobile phone network

- ③ Battery status of the connected mobile phone
- ④ ☎ (telephone ready) or ☎ (call active)
- ⑤ Contacts (→ page 274)
- ⑥ Recent Calls (→ page 277)
- ⑦ Connect Device (→ page 271)
- ⑧ Text Message
- ⑨ Active call
- ⑩ Options

Symbols ① to ④ are not shown until after a mobile phone has been connected to the multimedia system. The symbols depend on your mobile phone and your mobile phone network provider.

**Bluetooth® profile overview**

Bluetooth® profile of the mobile phone	Function
PBAP (Phone Book Access Profile)	Contacts are automatically displayed in the multimedia system
MAP (Message Access Profile)	Message functions can be used

**Telephony operating modes overview**

Depending on your equipment, the following telephony operating modes are available:

- A mobile phone is connected to the multimedia system via Bluetooth® (→ page 271).

**Notes on telephony**

**⚠ WARNING** Risk of distraction from operating integrated communication equipment while the vehicle is in motion

If you operate communication equipment integrated in the vehicle when driving, you will be distracted from the traffic situation. This could also cause you to lose control of the vehicle.

- ▶ Only operate this equipment when the traffic situation permits.
- ▶ If you cannot be sure of this, stop the vehicle whilst paying attention to road and traffic conditions and operate the equipment with the vehicle stationary.

**⚠ WARNING** Risk of distraction from operating mobile communication equipment while the vehicle is in motion

If you operate communication equipment integrated in the vehicle when driving, you will be distracted from the traffic situation.

This could also cause you to lose control of the vehicle.

Only operate this equipment when the vehicle is stationary.

You must observe the legal requirements for the country in which you are currently driving when operating mobile communication equipment in the vehicle.

Further information can be obtained from an authorized Mercedes-Benz Center or at: <http://www.mercedes-benz.com/connect>.

**Information on telephony**

The following situations can lead to the call being disconnected while the vehicle is in motion:

- there is insufficient network coverage in the area
- you move from one GSM or MUST transmitter/receiver area (cell) into another and no communication channels are free
- the SIM card used is not compatible with the network available



- a mobile phone with "Twin card" is logged into the network with the second SIM card at the same time

#### HD Voice®

- To improve voice quality, the multimedia system supports telephone calls in HD Voice®.
- In order to use this function, the mobile phones and the mobile phone network provider of the person you are calling must support HD Voice®.

Depending on the quality of the connection, the voice quality may fluctuate.

#### Connecting a mobile phone (Bluetooth® telephony)

##### Requirements:

- Bluetooth® is activated on the mobile phone (see the manufacturer's operating instructions).
- Bluetooth® is activated on the multimedia system (→ page 233).

Multimedia system:

➤ Phone ➤  Connect Device

#### Searching for a mobile phone

- Select **Connect New Device**.
- Select **Start Search on System**.  
The available mobile phones are displayed. If a new mobile phone is found, it is indicated by the  symbol.

#### Connecting a mobile phone (authorization using Secure Simple Pairing)

- Select the mobile phone.  
A code is displayed in the multimedia system and on the mobile phone.
- **If the codes match:** confirm the code on the mobile phone.

#### Connecting a mobile phone (authorization by entering a passkey)

- Select the mobile phone.
- Choose a one to sixteen-digit number combination as a passkey.

➤ **On the multimedia system:** enter the passkey and select .

➤ **On the mobile phone:** enter the passkey again and confirm.

- ⓘ Up to 15 mobile phones can be authorized on the multimedia system. Authorized mobile phones are reconnected automatically.

#### Switching mobile phones

##### Requirements:

- The mobile phones are authorized (→ page 271).

Multimedia system:

➤ Phone ➤  Connect Device

➤ In the device list, select a mobile phone which has already been authorized.

- ⓘ Only one mobile phone can be connected at any one time. The connected mobile phone is displayed at the top of the list.

### Disconnecting a mobile phone (de-authorizing)

Multimedia system:

➔ Phone ➔  Connect Device

- ▶ Select the mobile phone from the device list.
- ▶ Select .
- ▶ Select **Deauthorize**.
- ▶ Select **Yes**.

### Information on Near Field Communication (NFC)

NFC enables short-range wireless data transfer or (re)connection of a mobile phone with the multimedia system.

The following functions are available without having authorized a mobile phone:

- Transferring a URL to be viewed in the multimedia system (see the manufacturer's operating instructions).
- Setting up the vehicle's Wi-Fi access data via the system settings (→ page 235).

Further information can be found at: <http://www.mercedes-benz.com/connect>

### Using the mobile phone with Near Field Communication (NFC)

#### Requirements:

- NFC is activated on the mobile phone (see the manufacturer's operating instructions)
- The mobile phone's screen is switched on and unlocked (see the manufacturer's operating instructions)

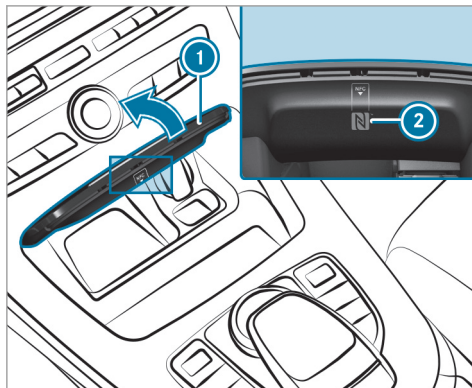

▶ **To connect a mobile phone:** open stowage compartment cover **1**.

▶ Place the NFC area of the mobile phone (see manufacturer's operating instructions) on NFC logo **2** on the inside of the cover. The mobile phone is connected to the multimedia system.

▶ **To change mobile phones:** place the NFC area of the mobile phone (see manufacturer's operating instructions) on NFC logo **2**. If the mobile phone has already been authorized on the multimedia system, it is now connected.

If the mobile phone is authorized on the multimedia system for the first time, it is connected after confirming the mobile phone instructions (see the manufacturer's operating instructions).

Further information can be found at: <http://www.mercedes-benz.com/connect>

## Setting the reception and transmission volume

### Requirements:

- A mobile phone is authorized (→ page 271).

Multimedia system:

☛ Phone ▶  Connect Device

This function ensures optimal language quality.

- ▶ Highlight the mobile phone in the device list.
- ▶ Select .
- ▶ Select [Reception Volume](#) or [Transmission Volume](#).
- ▶ Set the volume.

Further information on the recommended reception and transmission volume: <http://www.mercedes-benz.com/connect>

## Adjusting the call and ring tone volume

Multimedia system:

☛ System ▶  Audio ▶ Phone

- ▶ Select [Call Volume](#) or [Ringtone Volume](#).
- ▶ Set the volume.

## Starting/stopping mobile phone voice recognition

### Requirements

- The mobile phone is connected to the multimedia system (→ page 271).

### Starting mobile phone voice recognition

- ▶ Press and hold the  button on the multi-function steering wheel for more than one second.  
You can use mobile phone voice recognition.

### Stopping mobile phone voice recognition

- ▶ Press the  or  button on the multi-function steering wheel.

## Calls

### Using the telephone

Multimedia system:

☛ Phone ▶  Contacts

### Making a call

- ▶ Select [Numerical Keypad](#).

- ▶ Enter the number.
- ▶ Select .  
The call is made.

### Accepting a call

- ▶ Select [Accept](#).

### Rejecting a call

- ▶ Select [Reject](#).

### Ending a call

- ▶ Select .

### Activating functions during a call

- ▶ To show all functions, navigate down.

The following functions are available during a call:

- [End Call](#)
- [Make Additional Call](#)
- [Keyboard](#) (show to send DTMF tones)
- Switch [Mute Mic](#) on  or off .
- [Private Mode](#) (an active call in hands-free mode is transferred over to the telephone)

### Conducting calls with several participants

#### Requirements:

- There is an active call (→ page 273).
- Another call is being made.

#### Switching between calls

- ▶ Select call ●.  
The selected call is active. The other call is on hold.

#### Activating or ending a call on hold

- ▶ Select [Continue Call](#) or [End Call](#).

#### Conducting a conference call

- ▶ Select [Create Conference Call](#) in the telephone menu.  
The new participant is included in the conference call.

#### Ending an active call

- ▶ Select .
- ⓘ On some mobile phones, the call on hold is activated as soon as the active call is ended.

### Accepting/rejecting a waiting call

#### Requirements:

- There is an active call (→ page 273).

If you receive a call while already in a call, a message is displayed. An acoustic signal also sounds.

- ▶ Select [Accept](#).  
The incoming call is active. The previous call is on hold.
- ▶ Select [Reject](#).
- ⓘ This function and behavior depends on your mobile phone network provider and the mobile phone (see the manufacturer's operating instructions).

### Contacts

#### Information about the contacts menu

The contacts menu contains all contacts from existing data sources, e.g. mobile phone or memory card.

It is possible to store up to 6,000 contacts:

- 3,000 entries are for permanently saved contacts.
- 3,000 for contacts loaded from the mobile phone.

From the contacts menu, you can perform the following actions:

- Using the telephone:
  - Calling a contact (→ page 276)
  - Calling a new number (→ page 273)
- Navigation (→ page 250)
- Compose messages (→ page 278)

If a mobile phone is connected to the multimedia system (→ page 271) and automatic calling up (→ page 274) is activated, the mobile phone's contacts are displayed in the address book.

#### Downloading mobile phone contacts

Multimedia system:

➔ [Phone](#) ➔  [Options](#)

#### Automatically

- ▶ Activate  [Synchronize Contacts Automatically](#).

**Manually**

- ▶ Deactivate  [Synchronize Contacts Automatically](#).
- ▶ Select [Synchronize Contacts](#).

**Calling up contacts**

Multimedia system:

↳ [Phone](#) ▶ [Contacts](#)

Depending on the character set, the following options can be used to search for contacts:

- searching by initials
  - searching by name
  - searching by phone number
- ▶ Enter characters into the search field. A selection of possible contacts appears. Entering more characters into the search field narrows down the number of possible selections.
  - ▶ Select the contact.

A contact can contain the following details:

- phone numbers
- navigation addresses

- geo-coordinates
- Internet address

**Editing the format of a contact's name**



Multimedia system:



↳ [Phone](#) ▶ [Options](#) ▶ [Name Format](#)

The following options are available:

- [Last Name, First Name](#)
  - [Last Name First Name](#)
  - [First Name Last Name](#)
- ▶ Select an option.

**Overview of importing contacts****Importing contacts as electronic business cards**



Source	Requirements
 Memory card	The SD memory card is inserted.
 USB device	The USB device is inserted in the USB port.

Source	Requirements
 Bluetooth® connection	<p>If the sending of vCards via Bluetooth® is supported, vCards can be received on mobile phones or notebooks, for example.</p> <p>Bluetooth® is activated in the multimedia system and on the respective device (see the manufacturer's operating instructions).</p>
 Mobile phone	The mobile phone is connected to the multimedia system.

### Importing contacts into the contacts menu

Multimedia system:







 Phone   Options

-  Select **Import**.
-  Select an option.

### Saving a mobile phone contact

Multimedia system:



 Phone   Contacts

-  Select the  mobile phone contact.
-  Select .
-  Select **Save to Vehicle**.  
The contact saved in the multimedia system is identified by the  symbol.

### Calling a contact

Multimedia system:



 Phone   Contacts

-  Enter characters into the search field.
-  Select the contact.
-  Select the telephone number.  
The number is dialed.

### Selecting further options in the contacts menu

Multimedia system:

 Phone   Contacts

-  Select a contact.
-  Select .

Depending on the stored data, the following options are available:







- **Call**
  - **Send Text Message**
  - **Show Website** (if a web address has been stored)
  - **Navigate** (if an address has been stored)
  - **Save My Favorite**
  - **Send DTMF Tones** (for a number with DTMF tones)
-  Select an option.

### Deleting a contact

Multimedia system:

 Phone   Contacts

You can delete contacts stored in the vehicle.

-  Search for the contact.
-  Select the contact.
-  Select .
-  Select **Delete Contact**.
-  Select **Yes**.

## Call list

### Call list overview

If your mobile phone supports the PBAP Bluetooth® profile:

- The call lists from the mobile phone are displayed in the multimedia system.
- When connecting the mobile phone, you may have to confirm the connection for the PBAP Bluetooth® profile.

If your mobile phone does not support the PBAP Bluetooth® profile:

- The multimedia system generates its own call lists.
- The call list is not synchronized with the call lists in the mobile phone.

### Making a call from the call list

Multimedia system:

☛ Phone ▶ ☎ Recent Calls -  
Mobile phone

- ▶ Select an entry.  
The call is made.

### Options in the call list

Multimedia system:

☛ Phone ▶ ☎ Recent Calls -  
Mobile phone

- ▶ Highlight an entry.
- ▶ Select .

The following options are available:

- [Send Text Message](#)
- [Open Contact](#)

- ▶ Select an option.

## Text messages

### Overview of text message functions

If the connected mobile phone supports the MAP Bluetooth® profile, the text message functions can be used on the multimedia system.

You can obtain further information about settings and supported functions of Bluetooth®-capable mobile phones from an authorized Mercedes-Benz Center or at: <http://www.mercedes-benz.com/connect>

Some mobile phones require further settings after being connected to the multimedia system (see manufacturer's operating instructions).

New messages are identified by the  symbol in the multimedia system's display and an audible signal.

Depending on the mobile phone, the multimedia system only displays new incoming text messages or the 100 newest text messages.

### Configuring the displayed text messages

Multimedia system:

☛ Phone ▶ ⚙ Options ▶ Message Display

- ▶ Select .

A menu with the following options is shown:

- [All Messages](#)
- [New and Unread Messages](#)
- [New Messages](#)
- [Off](#) (The text messages are not displayed automatically.)

- ▶ Select an option.

**Reading text messages**

Multimedia system:

☞ Phone ▶  Text Message

**Reading a text message**

- ▶ Select a text message.  
The message text is displayed.

**Using the read-aloud function**

- ▶ Select a text message.
- ▶ Select **Read Aloud**.  
The text message is read aloud.

**Composing and sending a text message**

Multimedia system:

☞ Phone ▶  Text Message

- ▶ Navigate to the left twice.
- ▶ Select **Write New Text Message**.

**Adding a recipient**

- ▶ Select **Press to Add Recipient**.
- ▶ Select the contact.

**Dictating text**

- ▶ Select **Press to Dictate**.  
The app for the dictation function is loaded.  
If there was no prior Internet connection, a connection is now established.
- ▶ **To start the dictation function:** press the controller or touchpad.
- ▶ Say the message.  
The dictation ends automatically after you have finished speaking.  
After the voice message has been processed, it is shown as text.

**Editing text**

- ▶ Select the word.
- ▶ **To call up the correction menu:** press the controller or touchpad.  
The following options are available:
  - adjusting the capitalization of words (if supported by the character set)
  - expanding the choice of words
  - deleting the selection

- recording a new dictation
- ▶ **To leave the menu:** select **Done**.

**Sending text messages**

- ▶ Select **Send Text Message**.

**Replying to a text message**

Multimedia system:

☞ Phone ▶  Text Message

- ▶ Select the text message.
- ▶ Select .
- ▶ Select **Reply**.

**Calling a text message sender**

Multimedia system:

☞ Phone ▶  Text Message

- ▶ Select the text message.
- ▶ Select .
- ▶ Select **Call Sender**.



## Deleting text messages

Multimedia system:

↳ Phone >>  Text Message

▶ Select .

▶ **To delete a text message:** select **Delete**.

▶ **To change folders:** select **Switch Folder**.

▶ **Outbox**

or

▶ Select **Drafts**.

## Apple CarPlay™

### Overview of Apple CarPlay™

iPhone® functions can be used via the multimedia system using Apple CarPlay™. They are operated using the controller or the Siri® voice-operated control system. You can activate the voice-operated control system by pressing and holding the  button on the multifunction steering wheel.

When using Apple CarPlay™ via the voice-operated control system, the multimedia system can

still be operated via the Voice Control System (→ page 212).

Only one mobile phone at a time can be connected via Apple CarPlay™ to the multimedia system.

The availability of Apple CarPlay™ may vary according to the country.

The service provider is responsible for this application and the services and content connected to it.

### Information on Apple CarPlay™

While using Apple CarPlay™ various functions of the multimedia system, e.g. telephony or the media sources Bluetooth® audio and iPod®, are unavailable.

Only one route guidance can be active at a time. If route guidance is active on the multimedia system, it is closed when route guidance is started on the mobile phone.

## Connecting an iPhone® via Apple CarPlay™

### Requirements:

- Apple® operating system version iOS 8.3 or above is installed on the iPhone®.
- There is an Internet connection for the full range of functions for Apple CarPlay™.
- The iPhone® is connected to the multimedia system via the USB port  using a suitable cable (→ page 296).

Multimedia system:

↳ Connect >> Apple CarPlay

### Setting automatic or manual start

A message appears when connected for the first time.

- ▶ **Automatic start:** select **Automatically**. **Start Automatically** is activated .

Apple CarPlay™ will now start immediately after the iPhone® is connected to the multimedia system using a USB cable.

- ▶ **Manual start:** select **Manually**.
- ▶ Select the iPhone® in the device list.

### Accepting/rejecting the data protection regulations

A message with the data protection regulations appears.

- ▶ Select **Accept & Start**.

or

- ▶ Select **Decline & End**.

If you selected automatic start, you will have to start Apple CarPlay™ manually the next time you want to use it.

### Exiting Apple CarPlay™

- ▶ Press the  button on the multifunction steering wheel, for example.

- ⓘ If Apple CarPlay™ was not displayed in the foreground before disconnecting, the application starts in the background when reconnected. You can call up Apple CarPlay™ in the main menu.

### Calling up Apple CarPlay™ sound settings

Multimedia system:

- ➔ **Connect** ▶ **Apple CarPlay** ▶ **Sound**

- ▶ Select the tone menu (→ page 312).

### Ending Apple CarPlay™

Multimedia system:

- ➔ **Connect** ▶ **Apple CarPlay**

- ▶ Select **Disconnect**.

The connection is ended.

The mobile phone continues to be supplied with electricity.

or

- ▶ Disconnect the connecting cable between the mobile phone and multimedia system. Mercedes-Benz recommends disconnecting the connecting cable only when the vehicle is stationary.

### Android Auto

#### Android Auto overview

Mobile phone functions can be used with Android Auto using the Android operating system on the multimedia system. It is operated using the controller or the voice-operated control system. You can activate the voice-operated control system by pressing and holding the  button on the multifunction steering wheel.

When using Android Auto via the voice-operated control system, the multimedia system can still be operated via the Voice Control System (→ page 212).

Only one mobile phone at a time can be connected via Android Auto to the multimedia system.

The availability of Android Auto and Android Auto Apps may vary according to the country.

The service provider is responsible for this application and the services and content connected to it.

#### Information on Android Auto

While using Android Auto, various functions of the multimedia system, for example the media source Bluetooth® audio, are not available.

Only one route guidance can be active at a time. If route guidance is active on the multimedia system, it is closed when route guidance is started on the mobile phone.

## Connecting a mobile phone via Android Auto

### Requirements:

- The first activation of Android Auto on the multimedia system must be carried out when the vehicle is stationary for safety reasons.
- The mobile phone supports Android Auto from Android 5.0.
- The Android Auto app is installed on the mobile phone.
- In order to use the telephone functions, the mobile phone must be connected to the multimedia system via Bluetooth® (→ page 271).  
If there was no prior Internet connection, this is established with the use of the mobile phone with Android Auto.
- The mobile phone is connected to the multimedia system via the USB port  using a suitable cable (→ page 296).
- There is an Internet connection for the full range of functions for Android Auto.

Multimedia system:

↳ Connect ▶ Android Auto

- ▶ Select the mobile phone from the device list.

### Accepting/rejecting the data protection regulations

A message with the data protection regulations appears.

- ▶ Select **Accept & Start**.

or

- ▶ Select **Decline & End**.

### Activating automatic start

- ▶ Select **Start Automatically** .

### Starting manually

- ▶ Select the mobile phone from the device list.

### Exiting Android Auto

- ▶ Press the  button on the multifunction steering wheel, for example.

- ⓘ If Android Auto was not displayed in the foreground before disconnecting, the application starts in the background when reconnected.

You can call up Android Auto in the main menu.

### Calling up the Android Auto sound settings

Multimedia system:

↳ Connect ▶ Android Auto ▶ Sound

- ▶ Selecting the tone menu (→ page 312).

### Ending Android Auto

Multimedia system:

↳ Connect ▶ Android Auto

- ▶ Select **Disconnect**.

The connection is ended.

The mobile phone continues to be supplied with electricity.

or

- ▶ Disconnect the connecting cable between the mobile phone and multimedia system. Mercedes-Benz recommends disconnecting the connecting cable only when the vehicle is stationary.

## Transferred vehicle data when using Apple CarPlay™ and Android Auto

### Information on transferred vehicle data

When using Android Auto or Apple CarPlay™, certain vehicle data is transferred to the mobile phone. This enables you to get the best out of selected mobile phone services. Vehicle data is not directly accessible.

System information:

- Software release of the multimedia system
- System ID (anonymized)

The transfer of this data is used to optimize communication between the vehicle and the mobile phone.

To do this, and to assign several vehicles to the mobile phone, a vehicle identifier is randomly generated.

This has no connection to the vehicle identification number (VIN) and is deleted when the multimedia system is reset (→ page 242).

Driving status data:

- Transmission position engaged

- Distinction between parked, standstill, rolling and driving
- Day/night mode of the instrument cluster

The transfer of this data is used to alter how content is displayed to correspond to the driving situation.

Position data:

- Coordinates
- Speed
- Compass direction
- Acceleration direction

This data is only transferred while the navigation system is active in order to improve it (e.g. so it can continue functioning when in a tunnel).

### Mercedes-Benz mbrace® (USA only)

#### Making a call via the overhead control panel

Mercedes-Benz mbrace® is only available in the USA.

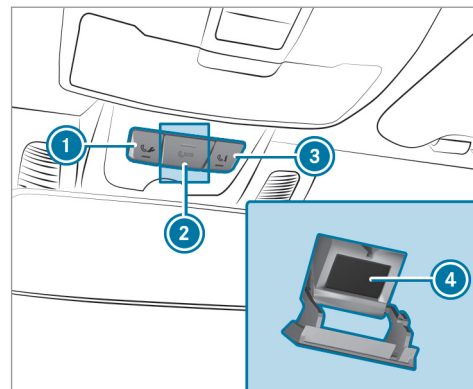

- ① Roadside Assistance call
- ② SOS button cover
- ③ MB Info call
- ④ SOS button

▶ **To make a Roadside Assistance call:** press button ①.  
This initiates a call to the Mercedes-Benz Customer Assistance Center.

- ▶ **To make an emergency call:** press SOS button cover ② briefly to open.
- ▶ Press and hold SOS button ④ for at least one second.  
This initiates a call to the Mercedes-Benz Customer Assistance Center.
- ▶ **To make an MB Info call:** press button ③.  
This initiates a call to the Mercedes-Benz Customer Assistance Center.

An emergency call can be initiated even if a Roadside Assistance or MB Info call is active. This has priority over all other active calls.

Calls via the overhead control panel are only possible with an available mobile phone network.

Further information on Mercedes-Benz mbrace® and other services can be found at: <http://www.mbusa.com>

### Information on the emergency call system

**⚠ WARNING** Risk of accident and injury despite pressing the SOS button

Even if you press the SOS button in an emergency, remaining in the vehicle may be dangerous for the following reasons:

- you see smoke inside or outside of the vehicle, e.g. if there is a fire after an accident
  - the vehicle is on a dangerous section of road
  - the vehicle is not visible or cannot easily be seen by other road users, particularly when dark or in poor visibility conditions
- ▶ Leave the vehicle immediately in this or similar situations as soon as it is safe to do so.
  - ▶ Move to a safe location along with other vehicle occupants.
  - ▶ In such situations, secure the vehicle in accordance with national regulations, e.g. with a warning triangle.

### Automatic emergency call

The emergency call is initiated in the following situations:

- the air bag is deployed.
- the Emergency Tensioning Devices are triggered.

You can end an automatically initiated emergency call yourself after 60 seconds.

### Manual emergency call

An emergency call can be initiated manually via the SOS button in the overhead control panel (→ page 282).

If you leave the vehicle immediately after pressing the SOS button, you do not know if Mercedes-Benz mbrace® has successfully made the emergency call.

### Initiated emergency call

When a voice connection is established between the Customer Assistance Center and the vehicle occupants, the following options apply:

- If the vehicle occupants are responsive: the Mercedes-Benz Customer Assistance Center

asks for more detailed information on the emergency.

- If the vehicle occupants are not responsive: an ambulance is sent to the vehicle immediately.

#### **Transferred data**

During the voice connection to the Customer Assistance Center, the following data is transferred:

- Current vehicle location
- Vehicle identification number

#### **Emergency call not possible**

- If the mobile phone network is unavailable, Mercedes-Benz mbrace® is not able to make an emergency call.

A corresponding message appears in the multimedia system display.

The indicator lamp flashes continuously.

In this case, seek assistance by other means.

#### **Information on the MB Info call**

An Info call to the Mercedes-Benz Customer Assistance Center has been initiated via the overhead control panel (→ page 282).

You can find information on the following topics:

- Mercedes-Benz mbrace® activation
- operating the vehicle
- nearest authorized Mercedes-Benz Center
- other products and services from Mercedes-Benz

Data is transmitted during the connection to the Mercedes-Benz Customer Assistance Center (→ page 284).

#### **Information on the Roadside Assistance call**

A Roadside Assistance call to the Mercedes-Benz Customer Assistance Center has been initiated via the overhead control panel:

- the problem with the vehicle is analyzed using remote diagnosis.

Further information about this can be obtained at: <http://www.mbusa.com>

- a qualified Mercedes-Benz technician carries out repairs on site and/or the vehicle will be towed to the nearest authorized Mercedes-Benz Center.

You may be charged for these services.

Data is transmitted during the connection to the Mercedes-Benz Customer Assistance Center (→ page 284).

#### **Transferred data during a service call**

---

In certain countries you must confirm the data transfer.

If you make service calls using Mercedes-Benz mbrace® (USA), transferred data includes the following:

**Overview of transferred data**

Service call	Transferred data
MB Info call Roadside Assistance call	<ul style="list-style-type: none"> <li>• Current vehicle location</li> <li>• Vehicle identification number</li> <li>• Service code</li> <li>• Selected data about the status of the vehicle</li> </ul>

**Online and Internet functions****Internet connection****Internet connection restrictions**

**⚠ WARNING** Risk of distraction from information systems and communications equipment

If you operate information and communication equipment integrated in the vehicle when driving, you will be distracted from the

traffic situation. This could also cause you to lose control of the vehicle.

- ▶ Only operate this equipment when the traffic situation permits.
- ▶ If you cannot be sure of this, stop the vehicle whilst paying attention to road and traffic conditions and operate the equipment with the vehicle stationary.

You must observe the legal requirements for the country in which you are currently driving when operating the multimedia system.

**USA:** to use Mercedes-Benz Apps and access the Internet, mbrace must be activated and operational. Furthermore, mbrace must be activated for Mercedes-Benz Apps and Internet access.

**Canada:** the multimedia system must be connected to a mobile phone via Bluetooth® or to an external device acting as a Wi-Fi hotspot. Furthermore, you need a valid mobile service contract with a data option, which is used to calculate the associated connection costs.

The Internet functions can only be used to a limited degree whilst driving.

**Setting up an Internet connection via Wi-Fi****Requirements**

- the Wi-Fi function is activated on the multimedia system (→ page 234).
- the Wi-Fi function is activated on the external device (see the manufacturer's operating instructions).
- Internet access via Wi-Fi is activated (see the manufacturer's operating instructions).

The Internet connection via Wi-Fi is restricted or does not function if:

- the mobile phone is switched off
- mobile data use is deactivated on the mobile phone
- the Wi-Fi function is deactivated on the multimedia system
- the Wi-Fi function is deactivated on the external device
- Internet access via Wi-Fi is deactivated on the external device

Multimedia system:

↳ System ▶▶  Connectivity ▶▶ Internet Settings ▶▶ Search for Wi-Fi Networks

- ▶ Select the network.
- ▶ Logging in to the Wi-Fi network (→ page 234).

### Setting up an Internet connection via Bluetooth®

#### Requirements:

- A mobile phone is connected to the multimedia system via Bluetooth® (→ page 271).

To connect via Bluetooth®, the mobile phone supports one of the following Bluetooth® profiles:

- DUN (**D**ial-**U**p **N**etworking)
- PAN (**P**ersonal **A**rea **N**etwork)

The Internet connection via Bluetooth® is restricted or does not function if:

- the mobile phone is switched off

- the mobile phone network coverage is insufficient
- mobile data use is deactivated on the mobile phone
- the Bluetooth® function on the multimedia system is switched off and the mobile phone is to be connected via Bluetooth®
- the Bluetooth® function is switched off on the mobile phone and the mobile phone is to be connected via Bluetooth®
- neither the mobile phone network nor the mobile phone allow simultaneous use of a telephone and an Internet connection
- the mobile phone has not been enabled for Internet access via Bluetooth®

If a mobile phone is connected to the multimedia system for the first time via Bluetooth®, you will be assisted through the process of setting up an Internet connection.

The Internet connection can also be configured manually.

Further information can be obtained at <http://www.mercedes-benz.com/connect> or from an authorized Mercedes-Benz Center.

Multimedia system:

↳ System ▶▶  Connectivity ▶▶ Internet Settings

### Bluetooth® connection via PAN

- ▶ Select the mobile phone.  
The Internet connection is established.

### Bluetooth® connection via DUN

- ▶ Select the mobile phone.
- ▶ **To select the predefined access data of the mobile phone network provider:** select [Predefined Settings](#).  
A list of countries appears.
- ▶ Select the country of your mobile phone network provider.  
The list of available providers appears.
- ▶ Select your mobile phone network provider.  
When an overview of the provider settings appears, make the necessary settings.



- ▶ Select [Confirm Settings](#).
- ▶ **To manually set the access data of the mobile phone network provider:** select [Manual Settings](#).  
An overview of the provider settings appears.
- ▶ Set the access data.
- ▶ Select [Confirm Settings](#).
- ⓘ Set the access data in accordance with your data package. Otherwise, additional costs may be incurred. You can contact your mobile phone network provider to obtain the precise access data.

### Switching the Bluetooth® profile



#### Requirements

- The mobile phone supports the DUN and PAN Bluetooth® profiles.

Multimedia system:

↳ System ▶  Connectivity ▶ Internet Settings

- ▶ **To switch from DUN to PAN:** select the mobile phone.

- ▶ Select .
- ▶ Select [Change Configuration](#).
- ▶ Activate  [Automatic Configuration](#).  
The Internet connection is automatically configured using the PAN Bluetooth® profile.
- ▶ **To switch from PAN to DUN:** select the mobile phone.
- ▶ Select .
- ▶ Select [Change Configuration](#).
- ▶ Deactivate  [Automatic Configuration](#).
- ▶ Select [Configure Settings Using COMAND](#).
- ▶ Configuring the Internet connection using preset or manual access data (→ page 286).

### Editing access data

#### Requirements

- The mobile phone supports the Bluetooth® DUN profile.

Multimedia system:

↳ System ▶  Connectivity ▶ Internet Settings

- ▶ Highlight the mobile phone.
- ▶ Select .
- ▶ Select [Change Configuration](#).
- ▶ **For mobile phones with PAN and DUN:** select [Configure Settings Using COMAND](#).
- ▶ Configure the Internet connection using preset or manual access data (→ page 286).

### Canceling Internet access permission for a mobile phone

Multimedia system:

↳ System ▶  Connectivity ▶ Internet Settings

- ▶ Highlight the mobile phone.
- ▶ Select .
- ▶ Select [Delete Configuration](#).
- ▶ Select [Yes](#).

### Displaying mobile phone details

Multimedia system:

→ System →  Connectivity → Internet Settings

- ▶ Highlight the mobile phone.
- ▶ Select .
- ▶ Select **Details**.

### Establishing an Internet connection

Multimedia system:

→ Connect

- ▶ For example, select  **Browser**.

- ① The multimedia system usually establishes the Internet connection automatically. If the multimedia system is not connected to the Internet, the Internet connection is established when an Internet application is used.

### Connection status

#### Connection status overview



- ① Display of existing connection and reception field strength of the connected device

#### Displaying the connection status

Multimedia system:

→ System →  Connectivity

- ▶ Select **Internet Status**.

- ① Depending on the means of connection, the approximate data volume transmitted is displayed.

### Mercedes-Benz Apps

#### Calling up Mercedes-Benz Apps

##### Requirements:

- The registration for the use of Mercedes-Benz Apps has been completed.
- The general terms and conditions have been confirmed.

Multimedia system:

→ Connect →  Mercedes-Benz Apps

- ▶ Select an app.

Further Mercedes-Benz Apps and information can be obtained at: <http://apps.mercedes-benz.com/apps/>

- ① The available features are country-dependent.

License fees may be applicable.

#### Operating Mercedes-Benz Apps using voice control

##### Requirements:

- The registration for the use of Mercedes-Benz Apps has been completed.

- The general terms and conditions have been confirmed.

The  symbol indicates that a Mercedes-Benz app can be used via voice control.

▶ Select a Mercedes-Benz App (→ page 288). The app menu is displayed.

▶ **To use voice control:** select  **Language.**

▶ Say the question or command.

- ⓘ Voice control is not available in all countries and languages.

## Web browser

### Calling up a web page

Multimedia system:

→ Con-  
nect ▶  Browser ▶  Enter URL

▶ Enter a web address.

▶ **To finish the entry and call up the website:** select  .

### Showing/hiding the web browser menu

If you call up a website by selecting a link, for example, the web browser menu is hidden.

▶ **To show/hide:** press the  button.

- ⓘ The web browser supports video playback.
- ⓘ No websites or videos are displayed while the vehicle is in motion.

### Web browser overview

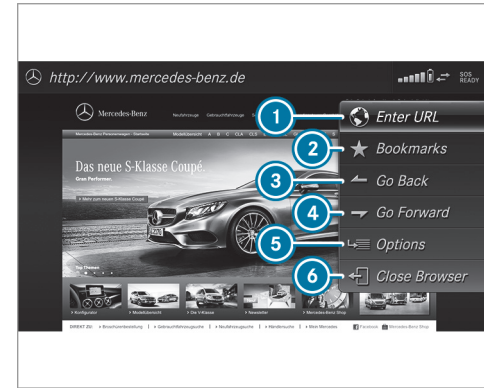

- ① URL entry
- ② Bookmarks
- ③ Web page, back
- ④ Web page, forwards
- ⑤ Options
- ⑥ To close the browser

**Calling up web browser options**

Multimedia system:

 Con-  
 nect  Browser  Options

The following functions are available:

- Refresh Page/Cancel
- Zoom
- Browser Settings
- Delete Browser Data

- ▶ Select an option.
- ▶ Make the desired changes to the settings.

**Calling up the web browser settings**

Multimedia system:

 Con-  
 nect  Browser  Options  Bro  
 wser Settings

The following functions are available:

- Block Pop-Ups
- Activate Javascript
- Allow Cookies

- ▶ Activate  or deactivate  the function.

**Deleting browser data**

Multimedia system:

 Con-  
 nect  Browser  Options  Del  
 ete Browser Data

The following options are available:

- All
- Cache
- Cookies
- Entered URLs
- Form Data

- ▶ Select an option.
- ▶ Select Yes.

**Managing bookmarks**

Multimedia system:

 Con-  
 nect  Browser  Bookmarks

**Selecting a bookmark**

- ▶ Select an entry.

**Creating a bookmark**

- ▶ Select **Add New Bookmark**.
- ▶ Enter a URL and a name.
- ▶ Select **OK**.

**Editing a bookmark**

- ▶ Highlight a bookmark.
- ▶ Select .
- ▶ Select **Edit**.
- ▶ Enter a URL and a name.
- ▶ Select **OK**.

**Deleting a bookmark**

- ▶ Highlight a bookmark.
- ▶ Select .
- ▶ Select **Delete**.
- ▶ Select **Yes**.

**Closing the browser**

Multimedia system:

 Connect  Browser  
 ▶ Select  Close Browser.

## Internet radio

### Calling up the Internet radio

#### Requirements:

- The Internet radio service is activated.
- The data volume is available.  
Depending on the country, data volume may need to be purchased.
- A fast Internet connection for data transmission free of interference.  
The services are country-dependent.  
For more information, consult an authorized Mercedes-Benz Center.

Multimedia system:

➔ Radio ➔  Radio Source

- ▶ Select **Tuneln Radio**.  
The Internet radio display appears. The last station set starts playing.
- ⓘ The connection quality depends on the local mobile phone reception.

### Internet radio overview

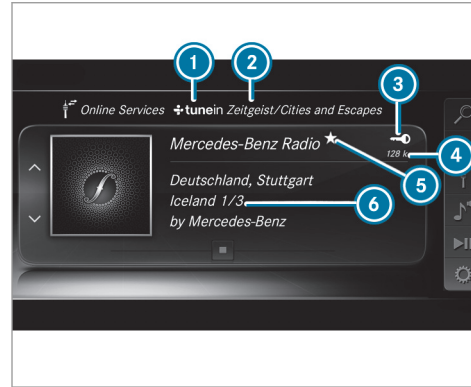

- 1 Internet radio provider
- 2 Selected category
- 3 Display (if connected to private user account)
- 4 Data transfer rate
- 5 Current station is stored as a favorite
- 6 Additional information on the current station

### Selecting and connecting to Internet radio stations

Multimedia system:

➔ Radio ➔  Radio Source ➔ Tuneln Radio ➔  Search

- ▶ Select a category.
- ▶ Select a station.  
The connection is established automatically.

or

- ▶ Select **Enter Address or POI**.
- ▶ Enter a station name using the entry field.

- ⓘ A relatively large volume of data can be transmitted when using Internet radio.

### Saving/deleting Internet radio stations as favorites

Multimedia system:

➔ Radio ➔  Radio Source ➔ Tuneln Radio

- ▶ Select a station.

▶ Press and hold the touchpad or controller until an audible signal sounds.

The  symbol appears by the station name.

▶ Select  **Favorites**.

The list of saved favorite stations appears.

or

▶ Create an account for the online provider (TuneIn radio) and then log in on the multimedia system.

Your favorites are imported to the multimedia system.

### Deleting favorites

▶ Select  **Favorites**.

▶ Select a station.

▶ Press and hold the touchpad or controller until an audible signal sounds.

The  symbol by the station name disappears.

### Setting the Internet radio options

Multimedia system:

 **Radio** ▶▶  **Radio Source** ▶▶ **TuneIn Radio** ▶▶  **Options**

The following options are available:

- **Select Stream:** select the stream quality.
- **Login to TuneIn Account:** log in to your TuneIn user account.
- **Log Out of Account:** log out of your TuneIn user account.

▶ Select an option.

### Media

#### Audio mode

#### Information on the audio mode

 **WARNING** Risk of distraction when handling data storage media

If you handle a data storage medium while driving, your attention is diverted from the

traffic conditions. This could also cause you to lose control of the vehicle.

▶ Only handle a data storage medium when the vehicle is stationary.

Permissible file systems:

- FAT32
- exFAT
- NTFS

Permissible data storage medium:

- SD card
- USB storage device
- iPod®/iPhone®
- MTP devices
- Bluetooth® audio equipment

-  • The multimedia system supports a total of up to 50,000 files.
- Data storage media up to 2 TB are supported (32-bit address space).

## Supported formats:

- MP3
- WMA
- AAC
- WAV
- FLAC
- ALAC

**i** Observe the following notes:

- Due to the large variety of available music files regarding encoders, sampling rates and data rates, playback cannot always be guaranteed.
- Due to the wide range of USB devices available on the market, playback cannot be guaranteed for all USB devices.
- Copy-protected music files or DRM encrypted files cannot be played back.
- MP3 players must support Media Transfer Protocol (MTP).



Manufactured under license from Dolby Laboratories. Dolby, Dolby Audio and the double-D symbol are trademarks of Dolby Laboratories.



Gracenote, the Gracenote logo and logotype, "Powered by Gracenote", MusicID and Playlist Plus are either registered trademarks or trademarks of Gracenote, Inc. in the United States and/or other countries.

**Notes on copyright**

Audio files that you create or reproduce yourself for playback are generally subject to copyright protection. In many countries, reproductions, even for private use, are not permitted without the prior consent of the copyright holder. Make sure that you know about the applicable copyright regulations and that you comply with these.

### Activating media mode

Multimedia system:

→ Media →  Media Sources

- ▶ Select a media source.  
Playable music files are played back.

### Inserting/removing an SD card

**⚠ DANGER** Risk of fatal injury from swallowing SD cards

SD cards are small parts.

They could be swallowed and lead to choking.

- ▶ Keep SD cards out of the reach of children.

- ▶ Seek medical attention immediately if an SD card has been swallowed.

**!** **NOTE** Damage caused by high temperatures

High temperatures can damage the SD memory card.

- ▶ Remove the SD memory card after use and take it out of the vehicle.

Multimedia system:

→ Media →  Media Sources → Mem. Card

### Inserting

The multimedia connection unit is located in the stowage compartment under the armrest.

- ▶ Insert the SD memory card into the SD card slot until it engages. The side with the contacts must face downwards.  
Playable music files are played back.

### Removing

- ▶ Press the SD card.
- ▶ Remove the SD card.



## Overview of the audio mode

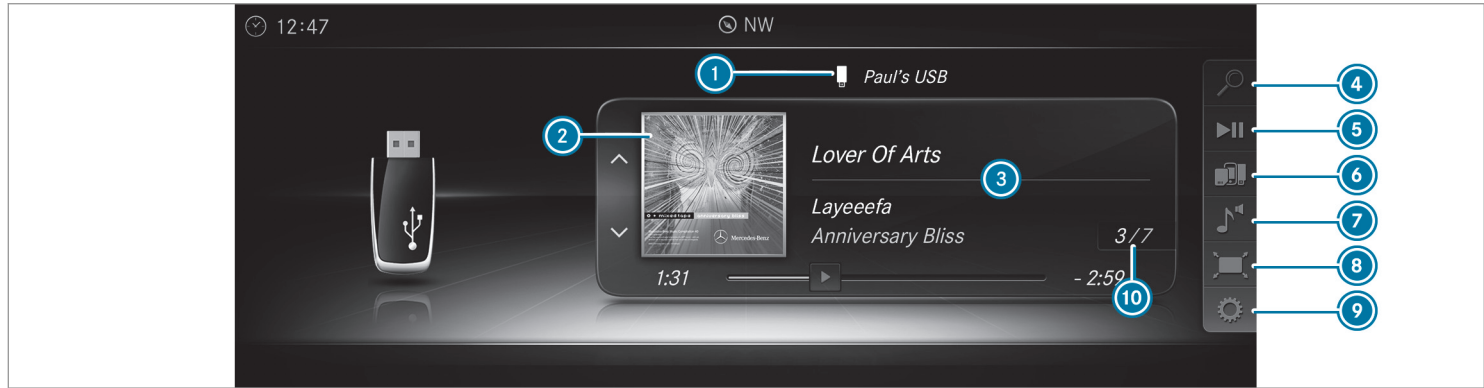

- ① Active data storage medium
- ② Album cover
- ③ Track, artist, album
- ④ Search

- ⑤ Playback Control
- ⑥ Media Sources
- ⑦ Sound

- ⑧ Full Screen (for video playback)
- ⑨ Options
- ⑩ Track number and number of tracks in the track list

## Connecting USB devices

**NOTE** Damage caused by high temperatures

High temperatures can damage USB devices.

- ▶ Remove the USB device after use and take it out of the vehicle.

The multimedia connection unit is found in the stowage compartment under the armrest and has two USB ports. Depending on the vehicle's equipment, additional USB ports can be found in the stowage compartment of the center console or rear folding compartment.

- ▶ Connect the USB device to the USB port. Playable music files are played back only if the corresponding media display is activated.
- ① Use the USB port identified by  to use Apple CarPlay™ and Android Auto.

### Selecting a track

Multimedia system:

 [Media](#)

### Selecting a track by skipping to a track

- ▶ **To skip backwards or forwards to a track:** navigate up or down.

### Selecting a track using the current track list

- ▶ Select .
- ▶ Select [Current Track List](#).
- ▶ Select a track.

### Selecting playback options

Multimedia system:

 [Media](#)  [Options](#)

### Playing back similar tracks

- ▶ Select [Play Similar Tracks](#).  
A track list with similar tracks is created and played back.

## Playback mode



- ▶ Select [Random Mode - Current Playlist](#).  
The current track list is played in random order.
- ▶ Select [Random Mode - Current Medium](#).  
All tracks on the active data storage medium are played in random order.
- ▶ Select [Normal Track Sequence](#).  
The current track list is played in the order it appears on the data storage medium.

## Controlling media playback

Multimedia system:

 [Media](#)  [Playback Control](#)

A bar with playback controls is shown.

- ▶ **To pause playback:** press the touchpad. The  symbol is displayed.
- ▶ **To resume playback:** press the touchpad again. The  symbol is displayed.

### To fast forward/rewind

- ▶ To move  on the timeline: swipe left or right on the touchpad.

### To hide the playback controls

- ▶ Press the  button.

### Video mode

---

#### Switching to video mode

Multimedia system:

 **Media** ▶  **Media Sources**

- ▶ Select a data storage medium.  
▶ Playable video files are played back.

The multimedia system supports the following formats:

- MPEG
  - AVI, DivX, MKV
  - MP4, M4V
  - WMV
-  Due to the large variety of available video files regarding encoders, sampling rates and data transfer rates, playback cannot always be guaranteed.  
Videos up to FullHD (1920x1080) are supported.

Copy-protected video files or DRM (Digital Rights Management) encrypted files cannot be played back.

### Overview of video mode

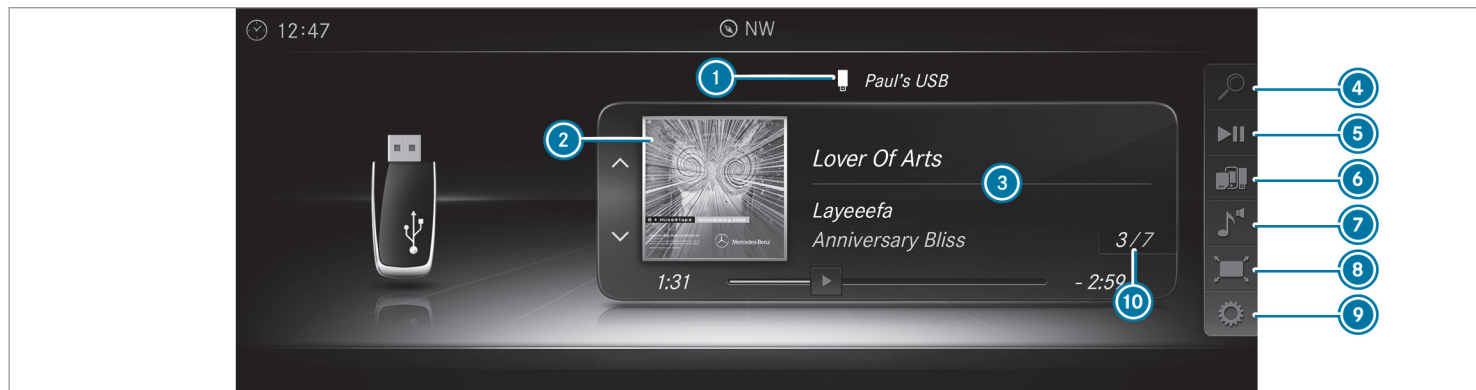

- ① Active data storage medium
- ② Album cover
- ③ Track, artist, album
- ④ Search

- ⑤ Playback Control
- ⑥ Media Sources
- ⑦ Sound
- ⑧ Full Screen

- ⑨ Options
- ⑩ Track number and number of tracks in the track list

### Activating/deactivating full-screen mode

Multimedia system:

↳ Media ▶  Media Sources

- ▶ Select a data storage medium.  
Playable video files are played back.
- ▶ **To activate full-screen mode:** select  Full Screen.
- ▶ **To deactivate full-screen mode:** press the touchpad.

### Changing video settings

Multimedia system:

↳ Media ▶  Options ▶ Picture Format

The following picture formats are available:

- Automatic
  - 16:9
  - 4:3
  - Zoom
- ▶ Select a picture format.

### Adjusting the brightness manually

- ▶ Select **Brightness**.
- ▶ Adjust the brightness.

### Media search

#### Starting the media search

Multimedia system:

↳ Media ▶  Search

Depending on the connected media sources and files, the following categories are listed:

- Current Track List
- Keyword Search
- Playlists
- Artists
- Albums
- Tracks
- Folder
- Music Genres
- Year
- Composers

- Videos
- Podcasts (Apple® devices)
- Audiobooks (Apple® devices)

- ▶ Select a category.

 The categories are available as soon as the entire media content has been read in and analyzed.

### Media Interface

#### Information about the Media Interface

Media Interface is a universal interface for the connection of mobile audio equipment. The multimedia system has two USB ports. The USB ports are located in the stowage compartment under the armrest.

#### Supported devices

The Media Interface allows you to connect the following data storage media:

- iPod®
- iPhone®
- MP3 player

## 300 Multimedia system

---

- USB devices

For details and a list of supported devices, visit our website at <http://www.mercedes-benz.com/connect>. Follow the instructions in the "Media Interface" section.

### Switching to Media Interface

Multimedia system:

 [Media](#)   [Media Sources](#)

- ▶ Connect a data storage medium to the USB port (→ page 296).

- ▶ Select a media device.  
▶ Playable music files are played back.

## Overview of Media Interface

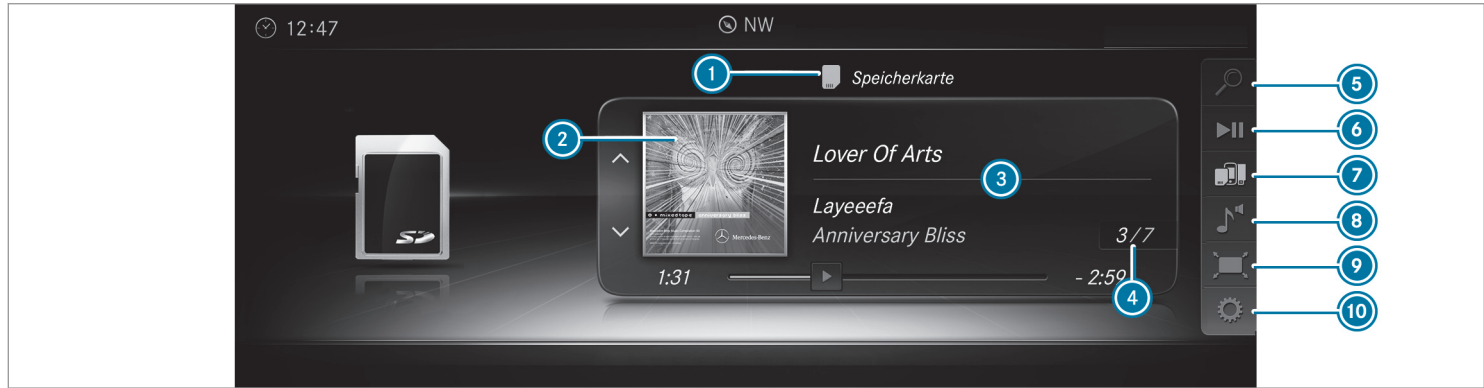

① Active data storage medium

② Cover

③ Artist, track and album

④ Track number and number of tracks in the track list

⑤ Search

⑥ Playback Control

⑦ Media Sources

⑧ Sound

⑨ Full Screen (video playback only)

⑩ Options

### Bluetooth® audio

### Information about Bluetooth® audio

## 302 Multimedia system

Before using your Bluetooth® audio equipment with the multimedia system for the first time, you will need to authorize it (→ page 303).

### Bluetooth® Audio overview

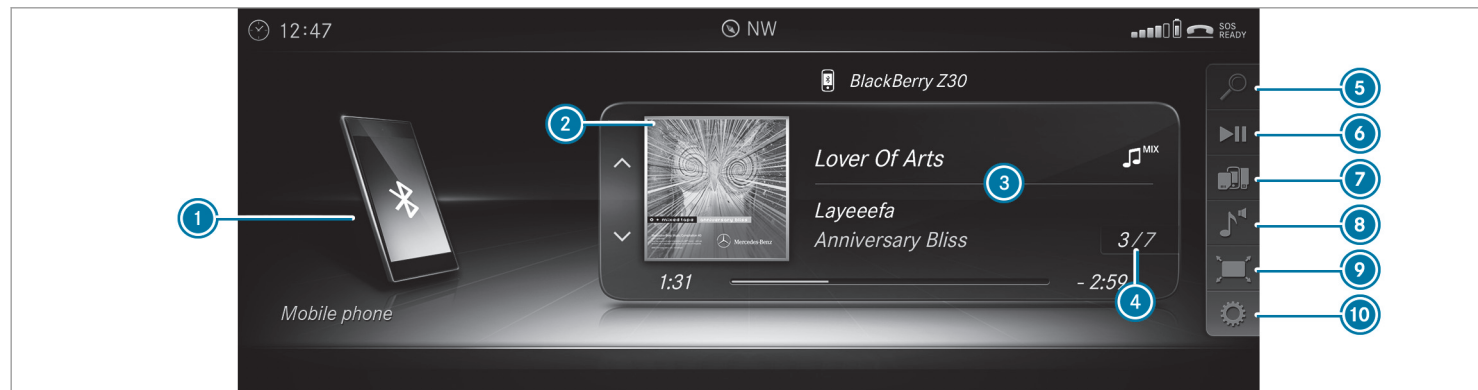

- ① Active data storage medium
- ② Cover art

- ③ Track, artist, album

- ④ Track number and number of tracks in the track list



- 5 Search
- 6 Playback Control

### Searching for and authorizing Bluetooth® audio equipment

#### Requirements

- Bluetooth® is activated on the multimedia system and audio equipment (→ page 233).
- The audio equipment supports the Bluetooth® audio profiles A2DP and AVRCP.
- The audio equipment is "visible" for other devices.

Multimedia system:

→ Media →  Media Sources →  Bluetooth Audio

#### Authorizing new Bluetooth® audio equipment

- ▶ Select .
- ▶ Select **Add New Bluetooth Audio Device**.
- ▶ Select **Start Search on System**.  
Detected audio equipment is displayed in the device list.

- 7 Media Sources
- 8 Sound

- ▶ Select a Bluetooth® audio device.  
Authorization starts. A code is displayed on the multimedia system and on the mobile phone.
- ▶ If the codes are identical, confirm on the audio device.  
The audio equipment is connected and playback starts.

#### Selecting Bluetooth® audio equipment that has already been authorized

- ▶ Select .
- ▶ Select a Bluetooth® audio device.

#### Establishing a connection from the Bluetooth® audio device

- The Bluetooth® device name of the multimedia system is **MB BLUETOOTH XXXXX**.
- ▶ Select **Search from Device**.

- 9 Full Screen (video playback only)
- 10 Options

- ▶ Start the authorization on the audio equipment (see manufacturer's operating instructions).  
A code is displayed on the multimedia system and on the mobile phone.
- ▶ Confirm on both devices if the codes are identical.  
The audio equipment is connected and playback starts.

With some audio equipment, playback must be initially started on the device itself so that the multimedia system can play the audio files.

- ⓘ Device-specific information on authorizing and connecting Bluetooth®-capable mobile phones can be obtained at <http://www.mercedes-benz.com/connect> or from an authorized Mercedes-Benz Center.

**Activating Bluetooth® audio**

Multimedia system:

↳ **Media** ▶  **Media Sources**

- ▶ Select  **Bluetooth Audio**.  
The multimedia system activates the connected Bluetooth® audio equipment.

**Selecting a music player**

Multimedia system:

↳ **Media** ▶  **Media Sources** ▶  **Bluetooth Audio**

- ▶ Select a Bluetooth® audio device.  
If multiple music players are present on the Bluetooth® audio equipment a list appears.
- ▶ Select a music player.  
Playback starts.

**Searching for a track**

Multimedia system:

↳ **Media** ▶  **Media Sources** ▶  **Bluetooth Audio**

- ▶ Select .

- ▶ Select a category.  
A track list appears.
- ▶ Select a track.
- ① The function is only available when the mobile phone and the music player selected on the mobile phone support this function.

**Switching Bluetooth® audio equipment via NFC****Requirements:**

- Observe the notes on using NFC (→ page 272).
- The Bluetooth® audio overview is displayed (→ page 304).
- ▶ Lightly press the NFC area on the mobile phone (see the manufacturer's operating instructions).  
If the mobile phone has already been authorized on the multimedia system as Bluetooth® audio equipment, it is now connected.  
If the mobile phone is authorized on the multimedia system as Bluetooth® audio equip-

ment for the first time, it is connected after confirming the instructions for the mobile phone (see the manufacturer's operating instructions).

**Disconnecting Bluetooth® audio equipment**

Multimedia system:

↳ **Phone** ▶  **Media Sources**

- ▶ Select a Bluetooth® audio device.
- ▶ Select  **Deauthorize**.
- ▶ Select **Yes**.

**Radio****Switching on the radio**

Multimedia system:

↳ **Radio**

- ▶ Alternatively: press the  button.  
The radio display appears. You will hear the last station played on the last frequency band selected.

## Radio overview



- ① Active frequency band
- ② Station name or set frequency
- ③ Artist, title, album and radio text

- ④ Station list
- ⑤ Presets
- ⑥ Radio Source

- ⑦ Sound
- ⑧ Tag This Song
- ⑨ Options

### Switching HD Radio on/off

Multimedia system:

↳ Radio ▶ ⚙️ Options ▶ HD Radio



▶ Switch the function on  or off .

ⓘ HD Radio Technology manufactured under license from iBiquity Digital Corporation. U.S. and Foreign Patents. HD Radio™ and the HD, HD Radio and "Arc" logos are proprietary trademarks of iBiquity Digital Corp.

### Setting the frequency band

Multimedia system:

↳ Radio ▶ 📻 Radio Source

HD Radio FM HD Radio AM and SiriusXM Radio can be selected.

▶ Select a frequency band.

### Selecting a radio station

Multimedia system:

↳ Radio

▶ Navigate up or down.

### Calling up the radio station list

Multimedia system:

↳ Radio ▶ 🔍

▶ Select a station.

### Searching for radio stations using station names or direct frequency entry

Multimedia system:

↳ Radio ▶ 🔍 ▶ 🔍

▶ Enter a station name or frequency.

▶ Select  .

The search results are displayed.

▶ Select a station.

### Storing radio stations

Multimedia system:

↳ Radio ▶ ⭐ Presets

▶ Select Store Current Station in the Presets.

### Editing radio station presets

Multimedia system:

↳ Radio ▶ ⭐ Presets

### Moving stations:

▶ Highlight a preset entry and navigate to the left.

- ▶ Select **Move Highlighted Station**.
- ▶ Select a preset.

#### Deleting stations:

- ▶ Highlight a preset entry and navigate to the left.
- ▶ Select **Delete Highlighted Station**.
- ▶ Select **Yes**.

#### Tagging music tracks

Multimedia system:

↳ **Radio**

If radio stations provide the relevant information, this function allows you to transfer information on the music track currently playing to an Apple® device. You can then purchase the audio file from the iTunes Store®.

- ▶ Select **♪→ Tag This Song**.
- ▶ The track information is saved.

#### Activating/deactivating radio text

Multimedia system:

↳ **Radio** ▶  **Options** ▶ **Display Radio Text Information**

- ▶ Activate  or deactivate  the function.

#### Satellite radio

##### Information on the satellite radio

SIRIUS XM® Satellite Radio offers more than 175 digital-quality radio channels providing 100% commercial-free music, sports, news and entertainment, for example. SIRIUS XM satellite radio employs a fleet of high-performance satellites to broadcast around the clock throughout the USA and Canada. The satellite radio program is available for a monthly fee. Information about this can be obtained from a Sirius XM® Service Center and at <http://www.siriusxm.com> (USA) or <http://www.siriusxm.ca> (Canada). Your new Mercedes-Benz vehicle comes with SIRIUS XM® Satellite Radio pre-installed at the factory. This service is free for a six-month trial period. About a month before the trial period ends, information

will be provided on how to extend this subscription. A message is shown, describing how the subscription can be extended.

- ⓘ Sirius, XM and all related marks and logos are trademarks of Sirius XM Radio Inc. and its subsidiaries. All other marks, channel names and logos are the property of their respective owners. All rights reserved.

##### Satellite radio restrictions

Satellite radio mode may be temporarily unavailable or interrupted for a variety of reasons. These include environmental or topographical conditions beyond the control of Mercedes-Benz USA, LLC. Thus, operation at certain locations may not be possible.

##### Registering satellite radio

###### Requirements:

- satellite radio equipment
- registration with a satellite radio provider
- if registration is not included when purchasing the system, your credit card details will be required to activate your account

Multimedia system:

↳ Radio ▶▶  Radio Source ▶▶ SiriusXM Radio ▶▶  Options

▶ Select **Service Information**.

The service information screen appears showing the radio ID and the current subscription status.

▶ Establish a telephone connection.

▶ Follow the service staff's instructions.

The activation process may take up to ten minutes.

 You can also have the satellite service activated online. To do so, please visit [http://](http://www.siriusxm.com)

[www.siriusxm.com](http://www.siriusxm.com) (USA) or <http://www.siriusxm.ca> (Canada).

### Switching on satellite radio

Multimedia system:

↳ Radio ▶▶  Radio Source

▶ Select **SiriusXM Radio**.

## Overview of the satellite radio

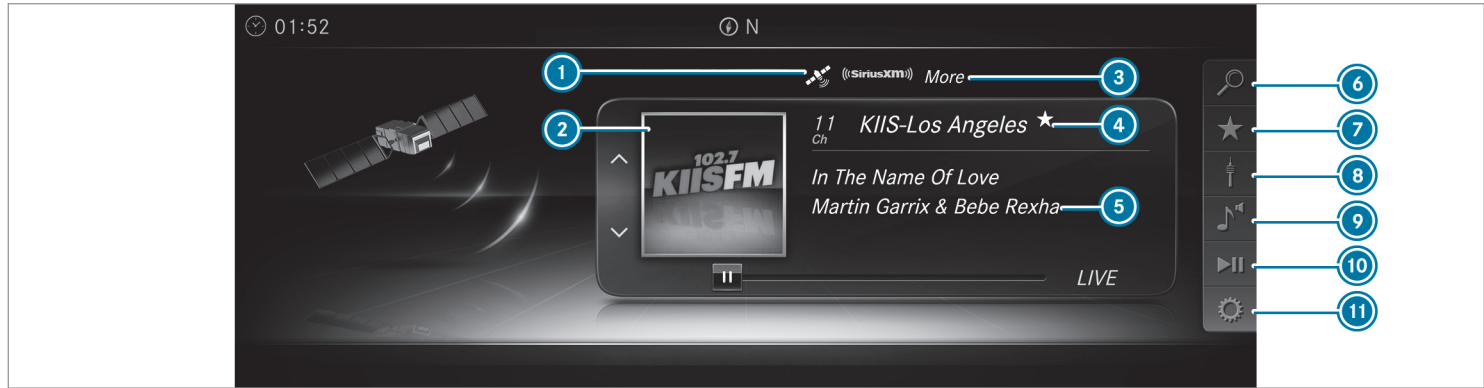

- ① Active frequency band
- ② Logo or album art (if available)
- ③ Category
- ④ Channel name

- ⑤ Channel information
- ⑥ SiriusXM Radio Channels
- ⑦ Presets
- ⑧ Radio Source

- ⑨ Sound
- ⑩ Playback Control
- ⑪ Options

**Selecting a satellite radio category**

Multimedia system:

↳ Radio ▶  Radio Source ▶ SiriusXM Radio ▶  SiriusXM Radio Channels ▶ Category

- ▶ Select a category.

**Selecting a satellite radio channel**

Multimedia system:

↳ Radio ▶  Radio Source ▶ SiriusXM Radio

- ▶ Navigate up or down.

**Saving or deleting a satellite radio channel**

Multimedia system:

↳ Radio ▶  Radio Source ▶ SiriusXM Radio ▶  Presets

- ▶ Select Store Current Station in the Presets.

**Moving a channel**

- ▶ Select **Options**.
- ▶ Select **Move Highlighted Station**.
- ▶ Select a preset.

**Deleting a channel**

- ▶ Select **Delete Highlighted Station**.
- ▶ Select a preset.

**Displaying PEG information for the current channel**



Multimedia system:

↳ Radio ▶  Radio Source ▶ SiriusXM Radio ▶  Options

- ▶ Select **EPG Information about Current Channel**.

**Setting the parental control**

Multimedia system:

↳ Radio ▶  Radio Source ▶ SiriusXM Radio ▶  Options ▶ Parental Control

- ▶ Activate the function .
- ▶ Determine a four-digit character sequence and select **OK**.
- ▶ All channels with adult content are locked.

**Unlocking a channel**

- ▶ Enter the four-digit character sequence and select **OK**.
- ▶ All channels with adult content are unlocked.

**Music and sport alerts function**

This function enables you to program an alert for your favorite artists, tracks or sporting events. Music alerts can be saved whilst a track is being played and sport alerts can be saved during a live game. You can also specify sport alerts via the menu option. The system then continuously searches through all the channels. If a match is found with a stored alert, you will be informed.

**Setting music and sport alerts**

Multimedia system:

↳ Radio ▶  Radio Source ▶ SiriusXM Radio ▶  Options ▶ Alert for Artist, Song & Sporting Event

**Setting a music alert**

- ▶ Select **Add New Alert**.
- or
- ▶ Select **Manage Artist & Song Alerts**.



- ▶ Select  **Options**.

The following options are available:

- [Mark This Entry](#)
- [Unmark This Entry](#)
- [Mark All Entries](#)
- [Unmark All Entries](#)
- [Delete This Entry](#)
- [Delete All Entries](#)

- ▶ Select an option.

- ▶ [Activate Artist & Song Alerts](#) .

The alert is set for the current artist or track. If a match is found, a prompt appears asking whether you wish to change to the station.

### Setting a sport alert

- ▶ Select [Add New Alert](#).

or

- ▶ Select [Manage Sports Alerts](#).
- ▶ Select [Select New Alerts](#).

or

- ▶ Select [Edit Alerts](#).
- ▶ Select a team from a league.

- ▶ [Activate Sports Alerts](#) .

### Information on Smart Favorites and Tune Start

Stations in the station presets can be added as smart favorites. Smart favorites stations are automatically saved to temporary storage in the background. If you change to a smart favorite station, you can replay, pause or actively skip forward or back to broadcasts which you have missed. If Tune Start is activated and you change to another smart favorite station, the music track currently playing on the station is automatically restarted from the beginning of the track.

### Activating/deactivating Tune Start

Multimedia system:

 [Radio](#) ▶▶  [Options](#) ▶▶ [TuneStart](#)

- ▶ Activate  or deactivate  the function.

### Playback controls

Multimedia system:

 [Radio](#) ▶▶ ▶| [Playback Control](#)

You can pause the playback of the current station or skip forward or backward in the timeline.

This leaves live mode to access the internal temporary storage.

- ▶ **To fast forward/rewind:** turn the controller anti-clockwise or clockwise.
- ▶ **To jump to the previous/next song:** slide the controller to the left or right.
- ▶ **To pause playback:** select .
- ▶ **To return to live mode:** navigate to the end of the timeline.

### Displaying satellite radio service information

Multimedia system:

 [Radio](#) ▶▶  [Radio Source](#) ▶▶ [SiriusXM Radio](#) ▶▶  [Options](#)

- ▶ Select [Service Information](#).

## Sound

### Tone settings

### Information about the sound system

The sound system has a total output of 100 watts and is equipped with 7 speakers. It is

available for all functions in the radio and media modes.

### Calling up the sound menu

Multimedia system:

→ Media →  Sound

The following functions are available:

- Equalizer
- Balance and Fader
- Automatic Volume Adjustment
- Other Sound Settings

▶ Select a sound menu.

### Adjusting treble, mid-range and bass settings

Multimedia system:

→ Media →  Sound → Equalizer

- ▶ Select Treble, Mid Range or Bass.
- ▶ Change the settings.

### Activating/deactivating automatic volume adjustment

Multimedia system:

→ Media →  Sound → Automatic Volume Adjustment

Automatic volume adjustment compensates for differing volumes when changing between audio sources.

▶ Switch the function on  or off .

### Adjusting the balance/fader

Multimedia system:

→ Media →  Sound → Balance and Fader

▶ Adjust the balance and fader.

▶ To exit the menu: press the  button.

### Burmester® surround sound system

#### Information about the Burmester® surround sound system

The Burmester® surround sound system has a total output of 590 watts and is equipped with

13 speakers. It is available for all functions in the radio and media modes.

### Calling up the sound menu in the Burmester® surround sound system

Multimedia system:

→ Media →  Sound

The following functions are available:

- Equalizer
- Balance and Fader
- Automatic Volume Adjustment
- Surround Sound
- Sound Focus
- Other Sound Settings

▶ Select a function.

### Adjusting the treble, mid and bass settings on the Burmester® surround sound system

Multimedia system:

→ Media →  Sound → Equalizer

- ▶ Select Treble, Mid Range or Bass.
- ▶ Set the desired values.

### Activating/deactivating volume adjustment in the Burmester® surround sound system

Multimedia system:

↳ Media ▶  Sound ▶ Automatic Volume Adjustment

Automatic volume adjustment compensates for differing volumes when changing between audio sources.

▶ Switch the function on  or off .

### Adjusting the balance/fader in the Burmester® surround sound system

Multimedia system:

↳ Media ▶  Sound ▶ Balance and Fader

▶ Adjust the balance and fader.

▶ **To exit the menu:** press the  button.

### Switching surround sound on/off in the Burmester® surround sound system

Multimedia system:

↳ Media ▶  Sound ▶ Surround Sound

▶ Switch the function on  or off .

### Adjusting the sound focus in the Burmester® surround sound system

Multimedia system:

↳ Media ▶  Sound ▶ Sound Focus

▶ Adjust the sound focus.

### ASSYST PLUS service interval display

#### Function of the ASSYST PLUS service interval display

The ASSYST PLUS service interval display in the instrument display provides information on the remaining time or distance before the next service due date.

You can hide this service message using the back button on the left-hand side of the steering wheel.

You can obtain further information concerning the servicing of your vehicle from a qualified specialist workshop, e.g. an authorized Mercedes-Benz Center.

#### Displaying the service due date

On-board computer:

→ Service ► ASSYST PLUS

The next service due date is displayed.

► **To exit the display:** press the back button on the left-hand side of the steering wheel.

Make sure to observe the following further related subject:

- Operating the on-board computer (→ page 200).

#### Carrying out maintenance work at regular intervals

**!** **NOTE** Premature wear through failure to observe service due dates

Service work which is not carried out at the right time or incompletely can lead to increased wear and damage to the vehicle.

- Always observe the prescribed service intervals.
- Always have the prescribed service work carried out at a qualified specialist workshop.

#### Special service requirements

The prescribed service interval is based on normal operation of the vehicle. Maintenance work

will need to be performed more often than specified if the vehicle is operated under arduous conditions or increased loads, for example:

- regular city driving with frequent intermediate stops.
- if the vehicle is primarily used for short-distance driving.
- for frequent operation in mountainous terrain or on poor road surfaces.
- if the engine is often left idling for long periods.
- in particularly dusty conditions and/or if air-recirculation mode is frequently used.

In these or similar operating conditions, have the interior air filter, engine air cleaner, engine oil, oil filter etc. changed more frequently. The tires must be checked more frequently if the vehicle is operated under increased loads. Further information can be obtained at a qualified specialist workshop.

### Non-operational times with the battery disconnected

**The ASSYST PLUS service interval display can only calculate the service due date when the battery is connected.**

- ▶ Note down the service due date displayed on the instrument display before disconnecting the battery (→ page 314).

### Engine compartment

#### Active hood (pedestrian protection)

**Operation of the active hood (pedestrian protection)**

In certain accident situations, the risk of injury to pedestrians can be reduced by the actuation of the active hood. The rear area of the engine hood is raised by approximately 85 mm.

For the drive to the workshop, reset the triggered active hood yourself. If the active hood has been triggered, pedestrian protection may be limited.

A qualified specialist workshop must re-instate the full functionality of the active hood.

The active hood is not available in all countries.

#### Resetting the active hood

**⚠ WARNING** Risk of burns from hot component parts in the engine compartment

Certain component parts in the engine compartment can be very hot, e.g. the engine, the cooler and parts of the exhaust system.

- ▶ Let the engine cool down and only touch the component parts described as follows.

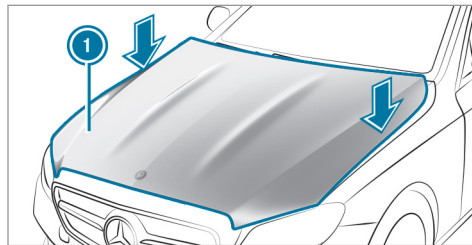

- ▶ With your hand flat, push down active hood **1** in the area around the hinges on both sides (arrows). The engine hood must engage in position.
- ▶ If the active hood can be raised slightly at the rear in the area of the hinges, repeat the step until it engages correctly.

#### Opening/closing the hood

**⚠ WARNING** Risk of accident if the engine hood is unlatched while driving

An unlocked engine hood may open up when the vehicle is in motion and block your view.

- ▶ Never unlatch the engine hood while driving.
- ▶ Before every trip, ensure that the engine hood is latched.

**⚠ WARNING** Risk of accident and injury when opening and closing the engine hood

When opening or closing the engine hood, it may suddenly drop into the end position.

There is a risk of injury for anyone in the engine hood's range of movement.

- ▶ Only open or close the engine hood when there are no persons in the engine hood's range of movement.

**⚠ WARNING** Danger of burns when opening the hood

If you open the hood when the engine has overheated or during a fire in the engine compartment, you could come into contact with hot gases or other escaping operating fluids.

- ▶ Before opening the hood, allow the engine to cool down.

- ▶ In the event of a fire in the engine compartment, keep the hood closed and call the fire service.

**⚠ WARNING** Risk of injury due to moving parts

Certain components in the engine compartment may continue to move or suddenly move again even after the ignition has been switched off, e.g. the cooler fan.

Make sure of the following before performing tasks in the engine compartment:

- ▶ Switch the ignition off.
- ▶ Never touch the danger zone surrounding moving component parts, e.g. the rotation area of the fan.
- ▶ Remove jewelry and watches.
- ▶ Keep items of clothing and hair away from moving parts.

**⚠ WARNING** Risk of injury from touching component parts under voltage

The ignition system and the fuel injection system work under high voltage. If you touch component parts which are under voltage, you could receive an electric shock.

- ▶ Never touch component parts of the ignition system or the fuel injection system when the ignition is switched on.

**⚠ WARNING** Risk of burns from hot component parts in the engine compartment

Certain component parts in the engine compartment can be very hot, e.g. the engine, the cooler and parts of the exhaust system.

- ▶ Let the engine cool down and only touch the component parts described as follows.

**⚠ WARNING** Risk of injury from using the windshield wipers while the engine hood is open

When the engine hood is open and the windshield wipers are set in motion, you can be trapped by the wiper linkage.

- ▶ Always switch off the windshield wipers and ignition before opening the engine hood.

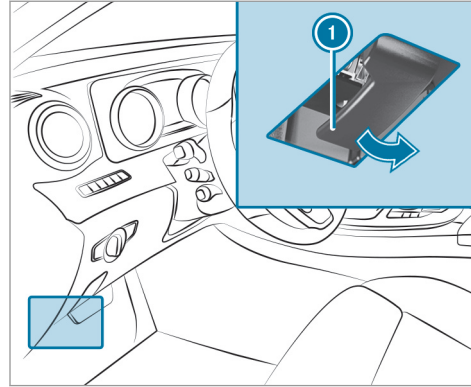

- ▶ **To open:** pull lever ① to release the engine hood.

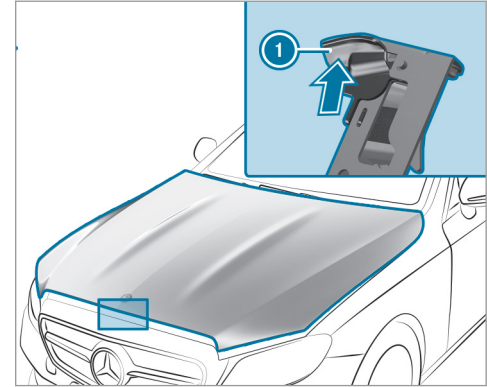

- ▶ Push hood catch ① upwards and lift the hood by approximately 15 in (40 cm).
- ▶ **To close:** lower the hood and let it fall from a height of approximately 8 in (20 cm).
- ▶ If the hood can still be lifted slightly, open the hood again and close it with a little more force until it engages correctly.

## Engine oil

### Checking the engine oil level using the oil dipstick

**⚠ WARNING** Risk of burns from hot component parts in the engine compartment

Certain component parts in the engine compartment can be very hot, e.g. the engine, the cooler and parts of the exhaust system.

- ▶ Let the engine cool down and only touch the component parts described as follows.

Depending on the engine, the oil dipstick may be installed in the engine compartment in different locations.

Waiting time before checking the oil level:

- Engine at normal operating temperature: five minutes.

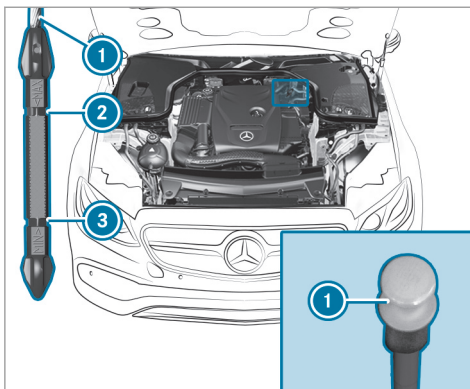

- ▶ Park the vehicle on a level surface.
- ▶ Pull oil dipstick ① out and wipe off.
- ▶ Slowly slide oil dipstick ① into the guide tube to the stop, and pull it out again after approximately three seconds.
  - Oil level is correct: oil level is between ② and ③.
  - Oil level too low: oil level is at ③ or below.

- Oil level too high: oil level is above ②.

- ▶ If the oil level is too low, top up with 1.1 US qt (1 l) of engine oil.
- ▶ If the engine oil level is too high, have the excess engine oil removed immediately at a qualified specialist workshop.

### Adding engine oil

**⚠ WARNING** Risk of burns from hot component parts in the engine compartment

Certain component parts in the engine compartment can be very hot, e.g. the engine, the cooler and parts of the exhaust system.

- ▶ Let the engine cool down and only touch the component parts described as follows.

**⚠ WARNING** Risk of fire and injury from engine oil

If engine oil comes into contact with hot component parts in the engine compartment, it may ignite.



- ▶ Make sure that no engine oil is spilled next to the filler opening.
- ▶ Allow the engine to cool off and thoroughly clean the engine oil from component parts before starting the vehicle.

**!** **NOTE** Engine damage caused by an incorrect oil filter, incorrect oil or additives

- ▶ Do not use engine oils or oil filters which do not correspond to the specifications explicitly prescribed for the service intervals.
- ▶ Do not alter the engine oil or oil filter in order to achieve longer change intervals than prescribed.
- ▶ Do not use additives.
- ▶ Follow the instructions in the service interval display regarding the oil change.

**!** **NOTE** Damage caused by topping up too much engine oil

Adding too much engine oil can cause damage to the engine or the catalytic converter.

- ▶ Have excess engine oil removed at a qualified specialist workshop.

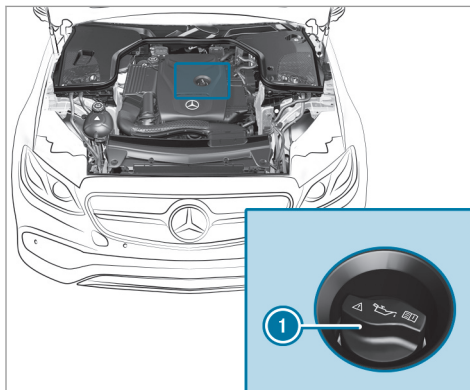

- ▶ Turn cap ① counter-clockwise and remove it.
- ▶ Add engine oil.
- ▶ Replace cap ① and turn it clockwise as far as it will go.
- ▶ Check the oil level again (→ page 318).

### Checking coolant level

**!** **WARNING** Risk of burns from hot component parts in the engine compartment

Certain component parts in the engine compartment can be very hot, e.g. the engine, the cooler and parts of the exhaust system.

- ▶ Let the engine cool down and only touch the component parts described as follows.

**!** **WARNING** Danger of burns from hot coolant

The engine cooling system is pressurized, particularly when the engine is warm. If you

open the cap, you could be scalded by hot coolant spraying out.

- ▶ Let the motor cool down before opening the cap.
- ▶ When opening the cap, wear gloves and protective eyewear.
- ▶ Slowly turn the cap half a turn to allow pressure to escape.

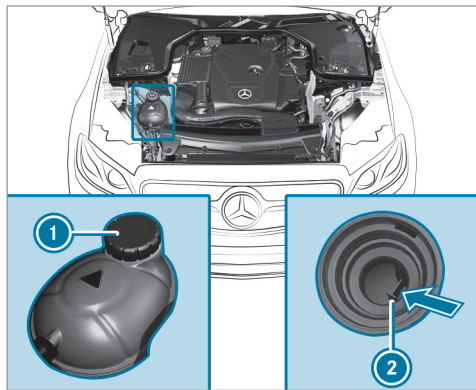

- ▶ Park the vehicle on a level surface.
- ▶ Check the coolant temperature display in the instrument cluster. The coolant temperature must be below 158 °F (70 °C).
- ▶ Slowly turn cap ① counter-clockwise to relieve overpressure.
- ▶ Continue turning cap ① counter-clockwise and remove it.

The coolant level is correct:

- if the engine is cold, up to marker bar ②.
  - if the engine is warm, up to 0.6 in (1.5 cm) over marker bar ②.
- ▶ If necessary, top up with coolant that has been approved by Mercedes-Benz.
- Further information on coolant (→ page 391)

### Adding washer fluid to the windshield washer system

**⚠ WARNING** Risk of burns from hot component parts in the engine compartment

Certain component parts in the engine compartment can be very hot, e.g. the engine, the cooler and parts of the exhaust system.

- ▶ Let the engine cool down and only touch the component parts described as follows.

**⚠ WARNING** Danger of burns when opening the hood

If you open the hood when the engine has overheated or during a fire in the engine compartment, you could come into contact with hot gases or other escaping operating fluids.

- ▶ Before opening the hood, allow the engine to cool down.

- ▶ In the event of a fire in the engine compartment, keep the hood closed and call the fire service.

**⚠ WARNING** - Risk of fire and injury from windshield washer concentrate

Windshield washer concentrate is highly flammable. It could ignite if it comes into contact with hot engine component parts or the exhaust system.

- ▶ Make sure that no windshield washer concentrate spills out next to the filler opening.

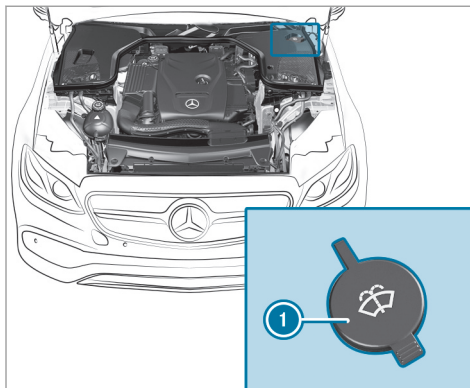

- ▶ Remove cap ① by the tab.
- ▶ Add washer fluid.

## Cleaning and care

### Information on washing the vehicle in a car wash

**⚠ WARNING** Risk of accident due to reduced braking effect after washing the vehicle

The braking effect is reduced after washing the vehicle.

- ▶ After the vehicle has been washed, brake carefully while paying attention to the traffic conditions until the braking effect has been fully restored.

To avoid damage to your vehicle when using a car wash, ensure the following beforehand:

- To avoid possible water ingress in the vehicle, it is preferable to use car washes which allow the high-pressure pre-wash to be deactivated (specification for the convertible program).
- It is imperative to avoid a subsequent hot-wax treatment.

- Remove the SmartKey in order to ensure that the wind deflector on the windshield retracts.
  - Active Distance Assist DISTRONIC and the HOLD function are deactivated.
  - The 360° Camera or the rear view camera is switched off.
  - The side windows and soft top are closed completely.
  - The blower for the ventilation/heating is switched off.
  - The windshield wiper switch is in position **0**.
  - In car washes with a towing mechanism: neutral **N** is engaged.
  - The SmartKey is at a distance of at least 10 ft (3 m) away from the vehicle, otherwise the trunk lid could open unintentionally.
- i** If, after the car wash, you remove the wax from the windshield and wiper rubber, this will prevent smearing and reduce wiper noise.

### Information on using a high-pressure cleaner

**⚠ WARNING** Risk of accident when using high-pressure cleaning equipment with round-spray nozzles

The water jet from a round-spray nozzle (dirt grinder) may cause damage to tires and suspension components that is not visible.

Components damaged in this way may fail unexpectedly.

- ▶ Do not use high-pressure cleaning equipment with round-spray nozzles to clean your vehicle.
- ▶ Damaged tires or suspension components must be replaced immediately.

To avoid damage to your vehicle, observe the following when using a high-pressure cleaner:

- Keep the SmartKey at least 10 ft (3 m) away from the vehicle. Otherwise the trunk lid could open unintentionally.
- Maintain a distance of at least 11.8 in (30 cm) to the vehicle.

- **Vehicles with decorative foil:** parts of your vehicle are covered with a decorative foil. Maintain a distance of at least 27.6 in (70 cm) between the foil-covered parts of the vehicle and the nozzle of the high pressure cleaner. Move the high-pressure cleaner nozzle around whilst cleaning.
- Observe the information on the correct distance in the equipment manufacturer's operating instructions.
- Do not point the nozzle of the high-pressure cleaner directly at sensitive parts such as tires, the soft top, the wind deflector net, slits, electrical component parts, batteries, light sources and ventilation slots.

### Washing the vehicle by hand

Observe the legal requirements, e.g. in a number of countries, washing by hand is only permitted in specially designated wash bays.

- ▶ Use a mild cleaning agent, e.g. car shampoo.

▶ Wash the vehicle with lukewarm water using a soft car sponge. When doing so, do not expose the vehicle to direct sunlight.

▶ Carefully hose the vehicle off with water and dry using a chamois. Take care not to point

the water jet directly towards the air inlet grille.

### Notes on paintwork/matt finish paintwork care

Observe the following information:

	Cleaning and care	Avoiding paintwork damage
<b>Paintwork</b>	<ul style="list-style-type: none"> <li>• Insect remains: soak with insect remover and rinse off the treated areas afterwards.</li> <li>• Bird droppings: soak with water and rinse off afterwards.</li> <li>• Coolant, brake fluid, tree resins, oils, fuel and greases: remove by gently rubbing with a cloth soaked in petroleum ether or lighter fluid.</li> <li>• Tar stains: use tar remover.</li> <li>• Wax: use silicone remover.</li> </ul>	<ul style="list-style-type: none"> <li>• Do not attach stickers, films or similar.</li> <li>• Remove dirt immediately, where possible.</li> </ul>
<b>Matt finish</b>	<ul style="list-style-type: none"> <li>• Only use care products approved by Mercedes-Benz.</li> </ul>	<ul style="list-style-type: none"> <li>• Do not polish the vehicle and light-alloy wheels.</li> <li>• Only use car washes that correspond to the latest engineering standards.</li> <li>• Do not use car wash programs with a final hot wax treatment.</li> <li>• Do not use paint cleaners, buffing or polishing products, gloss preservers, e.g. wax.</li> <li>• Always have paintwork repairs carried out at a qualified specialist workshop.</li> </ul>

## Notes on cleaning and care of the soft top

Observe the following information:

	Notes on cleaning and care	Avoiding soft-top damage
<b>Light soiling</b>	<ul style="list-style-type: none"> <li>• Clean the soft top when dry.</li> <li>• Rinse with clean water.</li> </ul>	<ul style="list-style-type: none"> <li>• Never use gasoline, thinners, tar remover or stain remover or other organic solvents.</li> <li>• Remove bird droppings immediately, as they are corrosive and can therefore cause the soft-top fabric to leak.</li> <li>• Never use a high-pressure cleaner.</li> <li>• Do not use sharp-edged equipment to remove ice and snow.</li> </ul>
<b>Normal to heavy soiling</b>	<ul style="list-style-type: none"> <li>• Clean the soft top with a brush and clean water.</li> <li>• Clean stains and other dirt with a brush and soft-top cleaning agents recommended and approved by Mercedes-Benz.</li> <li>• Always brush from front to back in the direction of the fabric.</li> </ul>	

Frequent cleaning reduces the soft top's resistance to dirt. To restore the effect, clean the soft top with the care products and cleaning agents recommended and approved by Mercedes-Benz. Incorrect cleaning and care, as well as aging, can cause the soft-top seams to leak. Have the soft-top seams sealed at a qualified specialist

workshop, e.g. at your Mercedes-Benz service center.

- ① Place a suitable cover over the soft top if you plan to leave the vehicle outside for a long period of time.

## Cleaning AIRCAP

### Cleaning the wind deflector

#### Requirements:

- The soft top is closed.
- Apply the electric parking brake manually.
- The ignition is switched on.

- Never use a high-pressure cleaner to clean the net of the wind deflector.

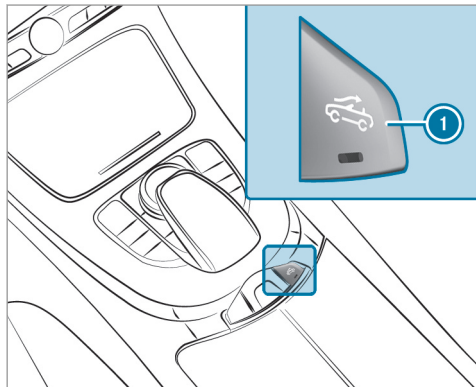

- ▶ Pull button ①.  
The wind deflector between the windshield and the soft top extends.

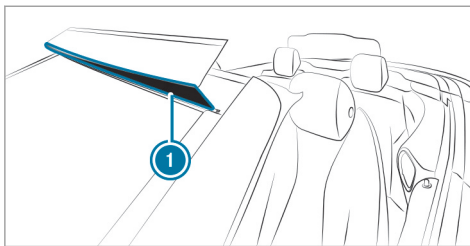

- ▶ **Light soiling:** clean wind deflector net ① with a soft brush or a moist cloth.
- ▶ **Heavier soiling:** clean wind deflector net ① with care products and cleaning agents recommended and approved by Mercedes-Benz.
- ▶ Subsequently, rinse off with clean water.

### Cleaning the wind screen

#### Requirements:

- The soft top is open.
- Apply the electric parking brake manually.
- The ignition is switched on.

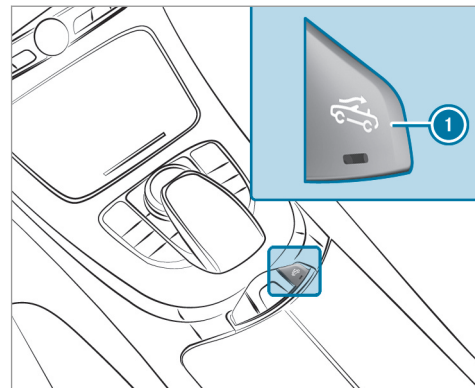

- ▶ Pull button ①.  
The AIRCAP wind screen moves upwards.



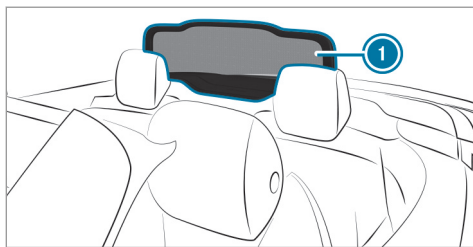

- ▶ Clean wind screen net ① with a damp cloth in conjunction with the care products and cleaning agents recommended and approved by Mercedes-Benz.

### Cleaning the folding draft stop

#### Requirements:

- Never use a high-pressure cleaner to clean the net of the wind deflector.

- Observe the notes on the correct installation and stowing location of the folding draft stop (→ page 80).
- ▶ Clean the net of the folding draft stop with a damp cloth in conjunction with the care products and cleaning agents recommended and approved by Mercedes-Benz.

### Notes on care of vehicle parts

- ⚠ **WARNING** Risk of entrapment if the windshield wipers are switched on while the windshield is being cleaned

If the windshield wipers are set in motion while you are cleaning the windshield or wiper blades, you can be trapped by the wiper arm.

- ▶ Always switch off the windshield wipers and the ignition before cleaning the windshield or wiper blades.

- ⚠ **WARNING** Risk of burns from tailpipes and tailpipe trim

The tailpipe and tailpipe trim can become very hot. If you come into contact with these parts of the vehicle, you could burn yourself.

- ▶ Always be particularly careful around the tailpipe and the tailpipe trim.
- ▶ Allow the vehicle parts to cool down before you touch them.

**Observe the following information:**

	<b>Notes on cleaning and care</b>	<b>Avoiding vehicle damage</b>
<b>Wheels/rims</b>	Use water and acid-free wheel cleaners.	<ul style="list-style-type: none"><li>• Do not use acidic wheel cleaners to remove brake dust. This could damage wheel bolts and brake components.</li><li>• To avoid corrosion of the brake discs and brake pads, drive the vehicle for a few minutes after cleaning before parking it. The brake discs and brake pads warm up and dry out.</li></ul>
<b>Windows</b>	Clean the windows on the inside and outside using a damp cloth and cleaning agents recommended by Mercedes-Benz.	Do not use dry cloths or abrasive or solvent-based cleaning agents to clean the inside of windows.
<b>Wiper blades</b>	Fold out the wiper blades and clean them using a damp cloth.	Do not clean the wiper blades too often.
<b>Exterior lighting</b>	Clean the windows with a wet sponge and mild cleaning agent, e.g. car shampoo.	Only use cleaning agents or cleaning cloths that are suitable for plastic covers.
<b>Sensors</b>	Clean the sensors in the front and rear bumper and in the radiator grille with a soft cloth and car shampoo.	When using a high-pressure cleaner, maintain a minimum distance of 11.8 in (30 cm).

	Notes on cleaning and care	Avoiding vehicle damage
<b>Rear view camera and 360° Camera</b>	<ul style="list-style-type: none"> <li>• Open the camera cover with the multimedia system(→ page 183) .</li> <li>• Use clear water and a soft cloth to clean the camera lens.</li> </ul>	Do not use a high-pressure cleaner.
<b>Tailpipes</b>	Clean with cleaning agents recommended by Mercedes-Benz, particularly in the winter and after washing the vehicle.	Do not use acidic cleaning agents.

### Notes on care of the interior

**⚠ WARNING** Risk of injury from plastic parts breaking off after the use of solvent-based care products

Care and cleaning products containing solvents can cause surfaces in the cockpit to become porous.

When the airbags are deployed, plastic parts may break away.

- ▶ Do not use any care or cleaning products containing solvents to clean the cockpit.

**⚠ WARNING** Risk of injury or death from bleached seat belts

Bleaching or dyeing seat belts can severely weaken them.

This can, for example, cause seat belts to tear or fail in an accident.

- ▶ Never bleach or dye seat belts.

## Observe the following information:

	Cleaning and care	Avoiding vehicle damage
<b>Seat belts</b>	Clean with lukewarm and soapy water.	<ul style="list-style-type: none"> <li>Do not use chemical cleaning agents.</li> <li>Do not dry seat belts by heating them to over 176 °F (80 °C) or exposing them to direct sunlight.</li> </ul>
<b>Display</b>	Clean the surface carefully with a microfiber cloth and TFT/LCD display care product.	<ul style="list-style-type: none"> <li>Switch off the display and let it cool down.</li> <li>Do not use any other cleaning products.</li> </ul>
<b>Plastic trim</b>	<ul style="list-style-type: none"> <li>Clean with a damp microfiber cloth.</li> <li>For heavy soiling: use care product recommended by Mercedes-Benz.</li> </ul>	<ul style="list-style-type: none"> <li>Do not attach stickers, films or similar.</li> <li>Do not allow cosmetics, insect repellent or sun cream to come in contact with the plastic trim.</li> </ul>
<b>Real wood/trim elements</b>	<ul style="list-style-type: none"> <li>Clean with a microfiber cloth.</li> <li>Black piano-lacquer look: clean with a damp cloth and soap solution.</li> <li>For heavy soiling: use care product recommended by Mercedes-Benz.</li> </ul>	Do not use solvent-based cleaning agents, polishes or waxes.
<b>Roof lining</b>	Clean with a brush or dry shampoo.	
<b>Carpet</b>	Use carpet and textile cleaning agents recommended by Mercedes-Benz.	

	Cleaning and care	Avoiding vehicle damage
<b>Genuine leather seat covers</b>	<ul style="list-style-type: none"><li>• Clean with a damp cloth and then wipe with a dry cloth.</li><li>• Leather care: use leather care agents that have been recommended by Mercedes-Benz.</li></ul>	<p>Do not allow the leather to become too damp. Do not use a microfiber cloth.</p>
<b>DINAMICA seat covers</b>	Clean with a damp cloth.	Do not use a microfiber cloth.
<b>Artificial leather seat covers</b>	Clean with a damp cloth and 1% soapy water.	Do not use a microfiber cloth.
<b>Cloth seat covers</b>	Clean with a damp cloth and 1% soapy water and allow to dry.	

## Emergency

### Removing the safety vest

The safety vests are located in the safety vest compartments in the driver's and front passenger door stowage compartments.

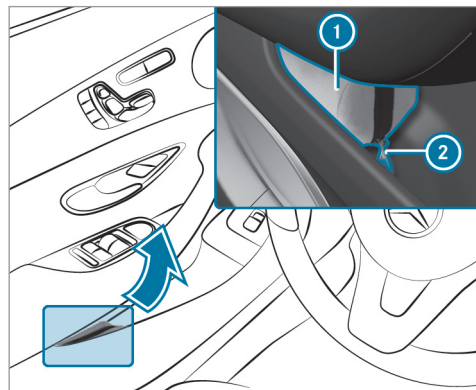

▶ **To remove:** pull out safety vest bag ① by loop ②.

▶ Open safety vest bag ① and pull out the safety vest.

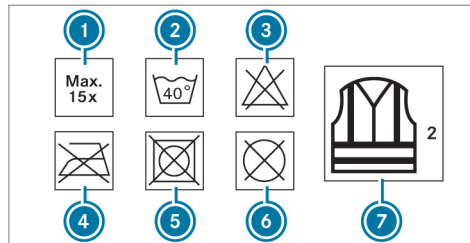

- ① Maximum number of washes
- ② Maximum wash temperature
- ③ Do not bleach
- ④ Do not iron
- ⑤ Do not use a laundry dryer
- ⑥ Do not dry-clean
- ⑦ This is a class 2 vest

The requirements defined by the legal standard are only fulfilled if the safety vest is the correct size and is fully closed.

Replace the safety vest if:

- it is damaged or dirt on the reflective strips can no longer be removed
- the maximum number of washes is exceeded
- the fluorescence of the safety vest has faded

## Flat tire

### Notes on flat tires

**⚠ WARNING** Risk of accident due to a flat tire

A flat tire severely affects the driving characteristics as well as the steering and braking of the vehicle.

#### Tires without run-flat characteristics:

- ▶ Do not drive on with a flat tire.
- ▶ Change the flat tire immediately with the emergency spare wheel or spare wheel. Alternatively, consult a qualified specialist workshop.

#### Tires with run-flat characteristics:

- ▶ Observe the information and warning notes on MOExtended tires (run-flat tires).

In the event of a flat tire, the following options are available depending on your vehicle's equipment:

- **Vehicles with MOExtended tires:** it is possible to continue the journey for a short period of time. Make sure you observe the notes on MOExtended tires (run-flat tires) (→ page 333).
- **Vehicles with a TIREFIT kit:** you can repair the tire so that it is possible to continue the journey for a short period of time. To do this, use the TIREFIT kit (→ page 334).
- **Vehicles with Mercedes-Benz mbrace®(USA only):** you can make a call for Roadside Assistance via the overhead control panel in the case of a breakdown (→ page 282).
- **All vehicles:** change the wheel (→ page 377).

### MOExtended tires (run-flat tires)

**▲ WARNING** Risk of accident when driving in limp-home mode

When driving in emergency mode the handling characteristics are impaired, e.g. when cornering, when accelerating strongly and when braking.

- ▶ Do not exceed the specified maximum speed.
- ▶ Avoid any abrupt steering and driving maneuvers as well as driving over obstacles (curbs, pot holes, off-road). This applies, in particular, to a loaded vehicle.
- ▶ Stop driving in the emergency mode if you notice:
  - banging noise
  - vehicle vibration
  - smoke which smells like rubber
  - continuous ESP® intervention
  - cracks in tire side walls

- ▶ After driving in emergency mode have the rims checked by a qualified specialist workshop with regard to their further use.
- ▶ The defective tire must be replaced in every case.

With MOExtended tires (run-flat tires), you can continue to drive your vehicle even if there is a total loss of pressure in one or more tires. However, the tire affected must not show any clearly visible damage.

You can recognize MOExtended tires by the MOExtended marking which appears on the side wall of the tire.

**Vehicles with tire pressure loss warning system:** MOExtended tires may only be used in conjunction with an activated tire pressure loss warning system.

**Vehicles with tire pressure monitoring system:** MOExtended tires may only be used in conjunction with an activated tire pressure monitoring system.

## 334 Breakdown assistance

If a pressure loss warning message appears in the multifunction display:

- Check the tire for damage.
- If driving on, observe the following notes.

### Driving distance possible in limp-home mode after the pressure loss warning:

Load condition	Driving distance possible in limp-home mode
Partially laden	50 miles (80 km)
Fully laden	19 miles (30 km)

- The driving distance possible in limp-home mode may vary depending on the driving style.
- Maximum permissible speed 50 mph (80 km/h).

If a tire has gone flat and cannot be replaced with an MOExtended tire, you can use a standard tire as a temporary measure.

### TIREFIT kit storage location

The TIREFIT kit is located under the trunk floor.

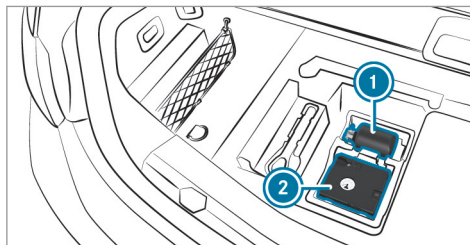

- ① Tire sealant bottle
- ② Tire inflation compressor

### Using the TIREFIT kit

#### Requirements

Have the following tools readily available:

- Tire sealant bottle
- Sticker TIREFIT
- Tire inflation compressor

You can use TIREFIT tire sealant to seal perforation damage of up to 0.16 in (4 mm), particularly those in the tire contact surface. You can use TIREFIT in outside temperatures down to -4 °F (-20 °C).

**⚠ WARNING** Risk of accident when using tire sealant.

In the following situations, the tire sealant is unable to provide sufficient breakdown assistance, as it is unable to seal the tire properly:

- There are cuts or punctures in the tire larger than those previously mentioned.
- The wheel rim is damaged.
- You have driven at a very low tire pressure or on a flat tire.

- ▶ Do not continue driving.
- ▶ Consult a qualified specialist workshop.



**⚠ WARNING** Risk of injury and poisoning from tire sealant

The tire sealant is harmful and causes irritation. Do not allow it to come into contact with the skin, eyes or clothing, and do not swallow it. Do not inhale tire sealant fumes. Keep the tire sealant away from children.

If you come into contact with the tire sealant, observe the following:

- ▶ Rinse off the tire sealant from your skin immediately using water.
- ▶ If tire sealant gets into your eyes, thoroughly rinse out the eyes using clean water.
- ▶ If tire sealant has been swallowed, immediately rinse out the mouth thoroughly and drink plenty of water. Do not induce vomiting and seek medical attention immediately.
- ▶ Change out of any clothes contaminated with tire sealant immediately.
- ▶ If allergic reactions occur, seek medical attention immediately.

**⚠ NOTE** Overheating due to the tire inflation compressor running too long

- ▶ Do not run the tire inflation compressor for longer than ten minutes without interruption.

Comply with the manufacturer's safety notes on the sticker on the tire inflation compressor.

Have the tire sealant bottle replaced in a qualified specialist workshop every five years.

- ▶ Do not remove any foreign objects which have entered the tire.

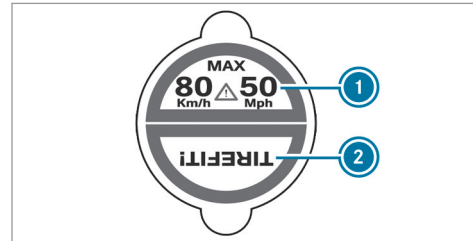

- ▶ Affix part ① of the TIREFIT sticker to the instrument cluster within the driver's field of vision.
- ▶ Affix part ② of the TIREFIT sticker near the valve on the wheel with the defective tire.

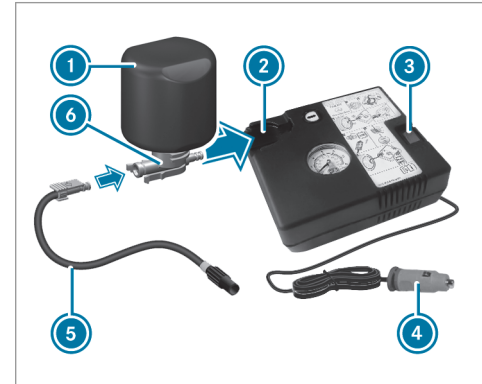

- ▶ Pull plug ④ with the cable and hose ⑤ out of the tire inflation compressor housing.

- ▶ Push the plug of hose ⑤ into flange ⑥ of tire sealant bottle ① until the plug engages.
- ▶ Place tire sealant bottle ① head downwards into recess ② of the tire inflation compressor.



- ▶ Remove the valve cap from valve ⑦ on the defective tire.
- ▶ Screw filling hose ⑧ onto valve ⑦.
- ▶ Insert plug ④ into a 12 V socket in your vehicle.
- ▶ Switch on the ignition.

- ▶ Press on and off switch ③ on the tire inflation compressor. The tire inflation compressor is switched on. The tire is inflated. First, tire sealant is pumped into the tire. The pressure may briefly rise to approximately 500 kPa (5 bar/73 psi).

**Do not switch off the tire inflation compressor during this phase.**

- ▶ Let the tire inflation compressor run for a maximum of ten minutes. The tire should then have attained a tire pressure of at least 200 kPa (2.0 bar/29 psi).

If tire sealant leaks out, make sure you clean the affected areas as quickly as possible. It is preferable to use clean water.

If you get tire sealant on your clothing, have it cleaned as soon as possible with perchloroethylene.

**If, after ten minutes, a tire pressure of 200 kPa (2.0 bar/29 psi) has not been achieved:**

- ▶ Switch off the tire inflation compressor.
- ▶ Unscrew the filling hose from the valve of the defective tire.

Please note that tire sealant may leak out when unscrewing the filling hose.

- ▶ Very slowly drive the vehicle forwards or reverse approximately 33 ft (10 m).
- ▶ Pump up the tire again. After a maximum of ten minutes the tire pressure must be at least 200 kPa (2.0 bar/29 psi).

**⚠ WARNING** Risk of accident due to the specified tire pressure not being reached

If the specified tire pressure is not reached after the specified time, the tire is too badly damaged. The tire sealant cannot repair the tire in this instance.

Damaged tires and a tire pressure that is too low can significantly impair braking and handling characteristics.

- ▶ Do not continue driving.
- ▶ Consult a qualified specialist workshop.

**If, after ten minutes, a tire pressure of 200 kPa (2.0 bar/29 psi) has been achieved:**

**⚠ WARNING** Risk of accident from driving with sealed tires

A tire temporarily sealed with tire sealant impairs the handling characteristics and is not suitable for higher speeds.

- ▶ Adapt your driving style accordingly and drive carefully.
- ▶ Do not exceed the specified maximum speed with a tire that has been repaired using tire sealant.

- ▶ Observe the maximum permissible speed for a tire sealed with tire sealant 50 mph (80 km/h).

- ▶ Fasten the upper section of the TIREFIT sticker to the instrument cluster where it will be easily seen by the driver.

**! NOTE** Staining caused by leaking tire sealant

After use, excess tire sealant may leak out from the filling hose.

- ▶ Therefore, place the filling hose in the plastic bag that contained the TIREFIT kit.

**🌿 ENVIRONMENTAL NOTE** Environmental pollution caused by environmentally irresponsible disposal

Tire sealant contains pollutants.

- ▶ Have the tire sealant bottle disposed of professionally, e.g. at an authorized Mercedes-Benz Center.

- ▶ Switch off the tire inflation compressor.
- ▶ Unscrew the filling hose from the valve of the defective tire.

- ▶ Store the tire sealant bottle and the tire inflation compressor.

▶ **Pull away immediately.**

- ▶ Stop after driving for approximately ten minutes and check the tire pressure using the tire inflation compressor. The tire pressure must now be at least 130 kPa (1.3 bar/ 19 psi).

**⚠ WARNING** Risk of accident due to the specified tire pressure not being reached

If the specified tire pressure is not reached after a brief drive, the tire is too badly damaged. The tire sealant cannot repair the tire in this instance.

Damaged tires and tire pressure that is too low can significantly impair the braking properties and the handling characteristics.

- ▶ Do not continue driving.
- ▶ Consult a qualified specialist workshop.

In cases such as the one mentioned above, contact an authorized Mercedes-Benz Center. Or

call 1-800-FOR-MERCEDES (in the USA) or 1-800-387-0100 (in Canada).

▶ Correct the tire pressure if it is still at least 130 kPa (1.3 bar/ 19 psi). See the Tire and Loading Information placard on the driver's side B-pillar or the tire pressure table in the fuel filler flap for values.

▶ **To increase the tire pressure:** switch on the tire inflation compressor.

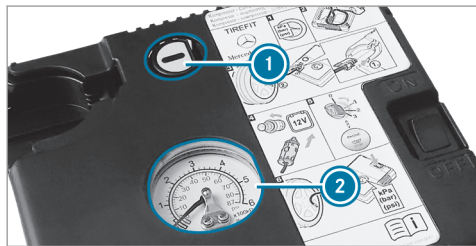

▶ **To reduce the tire pressure:** press pressure release button ① next to manometer ②.

- ▶ When the tire pressure is correct, unscrew the filling hose from the valve of the sealed tire.
- ▶ Screw the valve cap onto the tire valve of the sealed tire.
- ▶ Pull the tire sealant bottle out of the tire inflation compressor. The filling hose stays on the tire sealant bottle.
- ▶ Drive to the nearest qualified specialist workshop and have the tire, tire sealant bottle and filling hose replaced there.

### Battery (vehicle)

#### Notes on the 12 V battery

**⚠ WARNING** Risk of an accident due to work carried out incorrectly on the battery

Work carried out incorrectly on the battery can, for example, lead to a short circuit. This can lead to function restrictions in safety-rel-

evant systems, for example the lighting system, ABS (anti-lock braking system) or ESP® (Electronic Stability Program). The operating safety of your vehicle may be restricted.

You could lose control of the vehicle in the following situations:

- when braking
- in the event of abrupt steering maneuvers and/or when the vehicle's speed is not adapted to the road conditions

▶ In the event of a short circuit or a similar incident, contact a qualified specialist workshop immediately.

▶ Do not continue driving.

▶ Always have work on the battery carried out at a qualified specialist workshop.

- Further information on ABS (→ page 154)
- Further information on ESP®

For safety reasons, Mercedes-Benz recommends that you only use batteries which have been tested and approved for your vehicle by Mercedes-

Benz. These batteries provide increased impact protection to prevent vehicle occupants from suffering acid burns should the battery be damaged in the event of an accident.

**All vehicles except vehicles with a lithium-ion battery**

**⚠ WARNING** Risk of explosion due to electrostatic charge

Electrostatic charge can cause sparks which may ignite the highly flammable gas mixture in the battery.

- ▶ To discharge any electrostatic charge that may have built up, touch the metal vehicle body before handling the battery.

The highly flammable gas mixture is created while the battery is charging and during starting assistance.

**⚠ WARNING** Danger of chemical burns from the battery acid

Battery acid is caustic.

- ▶ Avoid contact with the skin, eyes or clothing.
- ▶ Do not lean over the battery.
- ▶ Do not inhale battery gases.
- ▶ Keep children away from the battery.
- ▶ Immediately rinse battery acid off thoroughly with plenty of clean water and seek medical attention immediately.

**All vehicles**

**🔥 ENVIRONMENTAL NOTE** Environmental damage caused by improper disposal of batteries



Batteries contain pollutants. It is illegal to dispose of them with the household rubbish.



Dispose of batteries in an environmentally responsible manner. Take discharged batteries to a qualified specialist workshop or to a collection point for used batteries.

If you have to connect the 12 volt battery, contact a qualified specialist workshop.

Comply with safety notes and take protective measures when handling batteries.



Risk of explosion



Fire, open flames and smoking are prohibited when handling the battery. Avoid creating sparks.



Electrolyte or battery acid is corrosive. Avoid contact with the skin, eyes or clothing. Wear suitable protective clothing, in particular gloves, an

apron and a face mask. Immediately rinse electrolyte or acid splashes off with clean water. Consult a doctor if necessary.

Wear safety glasses.



Keep children away.



Observe this Operator's Manual.



If you do not intend to use the vehicle over an extended period of time:

- Activate standby mode, or
- Connect the battery to a battery charger approved by Mercedes-Benz, or
- Consult a qualified specialist workshop to disconnect the battery

### Starting assistance and charging the 12 V battery

#### Vehicles with a lithium-ion battery

- ▶ When charging the battery and during starting assistance, always use the jump-start connection point in the engine compartment.

**!** **NOTE** Damage to the battery from overvoltage

When charging using a battery charger without a maximum charging voltage, the battery or the on-board electronics may be damaged.

- ▶ Only use battery chargers with a maximum charging voltage of 14.4 V.

#### All other vehicles

- ▶ When charging the battery and during starting assistance, always use the jump-start connection point in the engine compartment.

**!** **NOTE** Damaging the battery through overvoltage

When charging using a battery charger without a maximum charging voltage, the battery or the vehicle electronics may be damaged.

- ▶ Only use battery chargers with a maximum charging voltage of 14.8 V.

**!** **WARNING** Risk of explosion from hydrogen gas igniting

A battery generates hydrogen gas during the charging process. If there is a short circuit or sparks start to form, there is a danger of the hydrogen gas igniting.

- ▶ Make sure that the positive terminal of the connected battery does not come into contact with vehicle parts.
- ▶ Never place metal objects or tools on a battery.
- ▶ When connecting and disconnecting the battery, you must observe the described order for the battery clamps.

- ▶ When giving starting assistance, always make sure that you only connect battery terminals with identical polarity.
- ▶ During starting assistance, you must observe the described order for connecting and disconnecting the jumper cables.
- ▶ Do not connect or disconnect the battery clamps while the engine is running.

**⚠ WARNING** Risk of explosion during charging process and starting assistance

During the charging process and starting assistance, the battery may release an explosive gas mixture.

- ▶ Avoid fire, open flames, creating sparks and smoking.
- ▶ Make sure that there is sufficient ventilation during the charging process and during starting assistance.
- ▶ Do not lean over a battery.

If the indicator/warning lamps in the instrument cluster do not light up at low temperatures, it is very likely that the discharged battery has frozen.

**⚠ WARNING** Risk of explosion from a frozen battery

A discharged battery may freeze at temperatures slightly above or below freezing point.

During starting assistance or battery charging, battery gas may be released.

- ▶ Always thaw a frozen battery out first before charging it or performing starting assistance.

The service life of a battery that has been thawed may be dramatically shortened.

It is recommended that you have a thawed battery checked at a qualified specialist workshop.

### All vehicles

**!** **NOTE** Damage caused by numerous or extended attempts to start the engine

Numerous or extended attempts to start the engine may damage the catalytic converter due to non-combusted fuel.

- ▶ Avoid numerous and extended attempts to start the engine.

Observe the following points during starting assistance and when charging the battery:

- Only use undamaged jumper/charging cables with a sufficient cross-section and insulated terminal clamps.
- Non-insulated parts of the terminal clamps must not come into contact with other metal parts while the jumper/charging cable is connected to the battery/jump-start connection point.
- The jumper/charging cable must not come into contact with any parts which may move when the engine is running.

- Always make sure that neither you nor the battery is electrostatically charged.
- Keep away from fire and open flames.
- Do not lean over the battery.
- **When charging:** only use battery chargers tested and approved by Mercedes-Benz and read the battery charger's operating instructions before charging the battery.

Observe the additional following points during starting assistance:

- Starting assistance may only be provided using batteries with a nominal voltage of 12 V.
- The vehicles must not touch.
- **Gasoline engine:** only accept starting assistance if the engine and exhaust system are cold.

- ▶ Secure the vehicle by applying the electric parking brake.
- ▶ **Automatic transmission:** shift the transmission to position **P**.

- ▶ Make sure that the ignition and all electrical consumers are switched off.
- ▶ Open the hood.

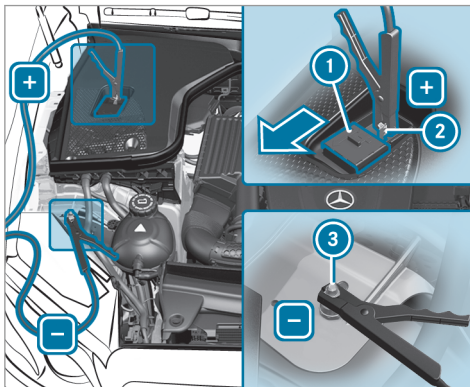

- ▶ Slide cover **1** of positive clamp **2** on the jump-starting connection point in the direction of the arrow.
- ▶ Connect positive clamp **2** on your vehicle to positive pole of the donor battery using the

jumper/charging cable. Always begin with positive clamp **2** on your own vehicle first.

- ▶ **During the starting assistance procedure:** start the engine of the donor vehicle and run at idle speed.
- ▶ Connect the negative pole of the donor battery and ground point **3** of your own vehicle by using the jumper/charging cable. Begin with the donor battery first.
- ▶ **During starting assistance:** start the engine of your own vehicle.
- ▶ **During the charging process:** start the charging process.
- ▶ **During starting assistance:** let the engines run for several minutes.
- ▶ **During starting assistance:** before disconnecting the jumper cable, switch on an electrical consumer in your own vehicle, e.g. the rear window heater or lighting.

When the starting assistance/charging process is complete:



- ▶ First, remove the jumper/charging cable from ground point ③ and negative pole of the donor battery, then from positive clamp ② and positive pole of the donor battery. Begin each time with the contacts on your own vehicle first.
- ▶ After removing the jumper/charging cable, close cover ① of positive clamp ②.

Further information can be obtained at a qualified specialist workshop.

### Tow starting or towing away



#### Permitted towing methods

Mercedes-Benz recommends transporting your vehicle in the case of a breakdown, rather than towing it away.

**!** **NOTE** Damage to the vehicle due to towing away incorrectly

- ▶ Observe the instructions and notes on towing away.

## Permitted towing methods

Vehicle equipment/towing method	 Both axles on the ground	 Front axle raised	 Rear axle raised
Vehicles with manual transmission	Yes, maximum 31 miles (50 km) at 31 mph (50 km/h)	Yes, maximum 31 miles (50 km) at 31 mph (50 km/h)	Yes, maximum 31 miles (50 km) at 31 mph (50 km/h)
Vehicles with automatic transmission	Yes, maximum 31 miles (50 km) at 31 mph (50 km/h)	No	Yes, if the steering wheel is fixed in the center position with a steering wheel lock.
4MATIC vehicles	Yes, maximum 31 miles (50 km) at 31 mph (50 km/h)	No	No

**Towing with a raised axle:** towing should be performed by a towing company.

### Towing the vehicle with both axles on the ground

- ▶ Observe the notes on the permitted towing methods (→ page 343) (→ page 344).

- ▶ Make sure that the battery is connected and charged.

When the battery is discharged:

- the engine cannot be started.
- the electric parking brake cannot be released or applied.

- **vehicles with automatic transmission:** the automatic transmission cannot be shifted to position **N** or **P**.

**i Vehicles with automatic transmission:** if the automatic transmission cannot be shifted to position **N**, or the multifunction display in the instrument cluster does not show anything, have the vehicle transported away (→ page 346). A towing vehicle with lifting equipment is required for vehicle transportation.

**!** **NOTE** Damage due to towing away at excessively high speeds or over long distances

The drivetrain could be damaged when towing at excessively high speeds or over long distances.

- ▶ A towing speed of 30 mph (50 km/h) must not be exceeded.
- ▶ A towing distance of 30 miles (50 km) must not be exceeded.

**!** **WARNING** Risk of accident when towing a vehicle which is too heavy

If the vehicle being tow-started or towed away is heavier than the permissible gross mass of your vehicle, the following situations can occur:

- The towing eye may become detached.
- The vehicle/trailer combination may swerve or even overturn.

▶ If another vehicle is tow-started or towed away, its weight must not exceed the permissible gross mass of your own vehicle.

If a vehicle must be tow-started or towed away, its weight must not exceed the permissible gross mass of the towing vehicle.

▶ Information on the permissible gross mass of the vehicle can be found on the vehicle identification plate.

▶ **Vehicles with automatic transmission:** do not open the driver's door or front passenger

door, otherwise the automatic transmission automatically shifts to position **P**.

▶ Install the towing eye (→ page 348).

▶ Attach the tow bar.

**!** **NOTE** Damage due to incorrect connection

▶ Only connect the tow rope or tow bar to the towing eyes.

▶ Deactivate the automatic locking mechanism (→ page 64).

▶ Do not activate the HOLD function.

▶ Deactivate Active Brake Assist (→ page 159).

▶ **Vehicles with automatic transmission:** shift the automatic transmission to position **N**.

▶ Release the electric parking brake.

**⚠ WARNING** Risk of accident due to limited safety-related functions during the towing process

Safety-related functions are limited or no longer available in the following situations:

- the ignition is switched off.
- the brake system or power steering system is malfunctioning.
- the energy supply or the on-board electrical system is malfunctioning.

When your vehicle is then towed away, significantly more effort may be required to steer and brake than is normally required.

- ▶ Use a tow bar.
- ▶ Make sure that the steering wheel can move freely, before towing the vehicle away.

**⚠ NOTE** Damage due to excessive tractive power

If you pull away sharply, the tractive power may be too high and the vehicles could be damaged.

- ▶ Pull away slowly and smoothly.

### Loading the vehicle for transport

- ▶ Observe the notes on towing away (→ page 344).
- ▶ Connect the tow bar to the towing eye to load the vehicle.
- ▶ **Vehicles with automatic transmission:** Shift the automatic transmission to position **[N]**.
- ▶ **Vehicles with automatic transmission:** The automatic transmission may be locked in position **[P]** in the event of damage to the electrical system. To shift to **[N]**, provide the on-board electrical system with power (→ page 340).

- ▶ Load the vehicle onto the transporter.
- ▶ **Vehicles with automatic transmission:** Shift the automatic transmission to position **[P]**.
- ▶ Use the electric parking brake to secure the vehicle and prevent it from rolling away.
- ▶ Only secure the vehicle by the wheels.

### Vehicles with ADS PLUS (Adaptive Damping System PLUS)

**⚠ WARNING** Risk of an accident when transporting vehicles with Adaptive Damping System PLUS

The reduced damping forces on the vehicle being transported can cause the vehicle/trailer combination to start to swing.

As a result, when transporting vehicles with the Adaptive Damping System PLUS, the vehicle/trailer combination may start to skid. Consequently, you could lose control of your vehicle.

- ▶ When transporting, ensure that:

- The vehicle has been loaded onto the transporter correctly
- The vehicle is secured at all four wheels with suitable tensioning straps
- The maximum permissible speed of 35 mph (60 km/h) is not exceeded when transporting

**!** **NOTE** Damage to the vehicle from securing it incorrectly

- ▶ After loading, the vehicle must be secured at all four wheels. Otherwise, the vehicle could be damaged.
- ▶ A minimum distance of 8 in (20 cm) up and 4 in (10 cm) down must be kept to the transport platform.
- ▶ Secure the vehicle on all four wheels after loading.

#### 4MATIC vehicles/vehicles with automatic transmission

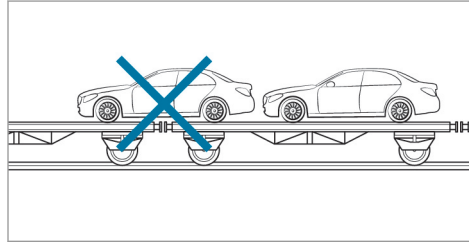

- ▶ Make sure that the front and rear axles come to rest on the same transportation vehicle.

**!** **NOTE** Damage to the drivetrain due to incorrect positioning

- ▶ Do not position the vehicle above the connection point of the transport vehicle.

#### Towing eye storage location

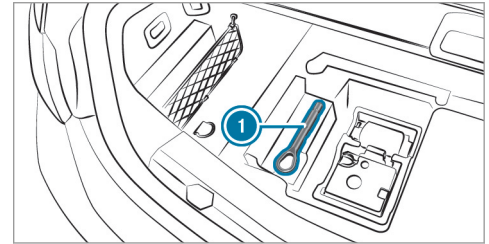

Towing eye ① is in a stowage space under the trunk floor.

## Installing the towing eye

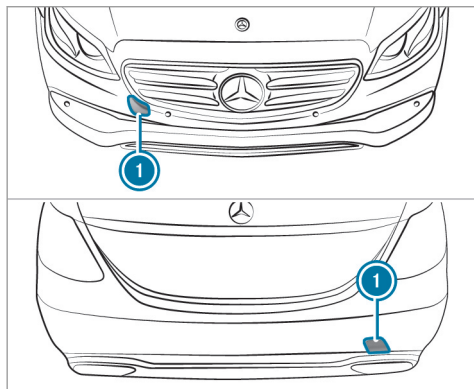

- ▶ Press the mark on cover ① inwards and remove.
- ▶ Screw in the towing eye clockwise as far as it will go and tighten.
- ① Make sure that cover ① engages in the bumper when you remove the towing eye.

**!** **NOTE** Damage due to incorrect use of the towing eye

When a towing eye is used to recover a vehicle, the vehicle may be damaged in the process.

- ▶ Only use the towing eye to tow away or tow start the vehicle.

## Tow starting the vehicle (emergency engine starting)

### Vehicles with automatic transmission

**!** **NOTE** Damage to the automatic transmission due to tow starting

The automatic transmission may be damaged in the process of tow starting vehicles with automatic transmission.

- ▶ Vehicles with automatic transmission must not be tow started.
- ▶ Vehicles with automatic transmission must not be tow started.

## Electrical fuses

### Notes on electrical fuses

**!** **WARNING** Risk of accident and injury due to overloaded lines

If you manipulate or bridge a faulty fuse or if you replace it with a fuse with a higher amperage, the electric line could be overloaded.

This could result in a fire.

- ▶ Always replace faulty fuses with specified new fuses containing the correct amperage.

**!** **NOTE** Damage caused by incorrect fuses

Incorrect fuses may cause damage to electrical components or systems.

- ▶ Only use Mercedes-Benz approved fuses with the correct fuse rating.

Blown fuses must be replaced with fuses of the same rating, which you can recognize by the colour and fuse rating. For fuses in the engine com-

partment and trunk, only use those fuses marked with an "S". The fuse ratings are listed in the fuse assignment diagram.

**Fuse assignment diagram:** on the fuse box in the trunk (→ page 351).

**! NOTE** Damage or malfunctions caused by moisture

Moisture may cause damage to the electrical system or cause it to malfunction.

- ▶ When the fuse box is open, make sure that no moisture can enter the fuse box.
- ▶ When closing the fuse box, make sure that the seal of the lid is positioned correctly on the fuse box.

If the newly inserted fuse also blows, have the cause traced and rectified at a qualified specialist workshop, e.g. a Mercedes-Benz Service Center.

Ensure the following before replacing a fuse:

- The vehicle is secured against rolling away.

- All electrical consumers are switched off.
- The ignition is switched off.

The electrical fuses are located in various fuse boxes:

- Fuse box on the driver's side of the engine compartment (→ page 349)
- Fuse box on the driver's side of the cockpit (→ page 350)
- Fuse box in the front passenger footwell (→ page 350)
- Fuse box in the trunk on the right-hand side of the vehicle, when viewed in the direction of travel (→ page 351)

### Fuse box in the engine compartment

Observe the notes on electrical fuses (→ page 348).

Requirements:

- You need a dry cloth and a screwdriver.

### Opening

**⚠ WARNING** Risk of injury from using the windshield wipers while the engine hood is open

When the engine hood is open and the windshield wipers are set in motion, you can be trapped by the wiper linkage.

- ▶ Always switch off the windshield wipers and ignition before opening the engine hood.

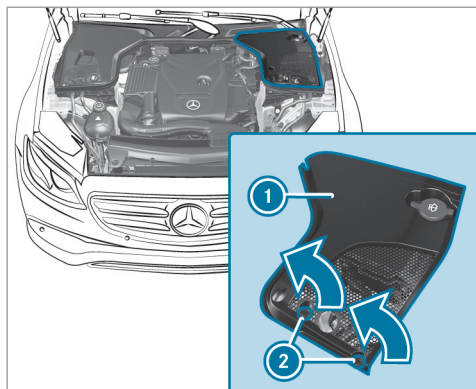

- ▶ Turn clip ② on cover ① a quarter-turn to the left.
- ▶ Pull cover ① upwards in the direction of the arrow.

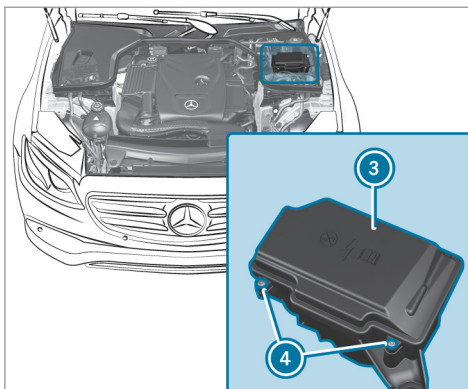

- ▶ Remove any existing moisture from the fuse box using a dry cloth.
- ▶ Loosen screws ④, remove fuse box lid ③ from the top.

#### Closing

- ▶ Check whether the seal is positioned correctly in the lid.

- ▶ Insert the lid into the bracket at the rear of the fuse box.
- ▶ Fold down lid of the fuse box and tighten screws ④.
- ▶ Insert cover ① on both sides and engage the safety clips.
- ▶ Turn clip ② on cover ① one quarter-turn to the right.
- ▶ Close the engine hood.

#### Dashboard fuse box

The fuse box is on the side of the dashboard under a cover.

- ▶ Contact an authorized Mercedes-Benz Center for further information.

#### Fuse box in the front-passenger footwell

Observe the notes on electrical fuses (→ page 348).



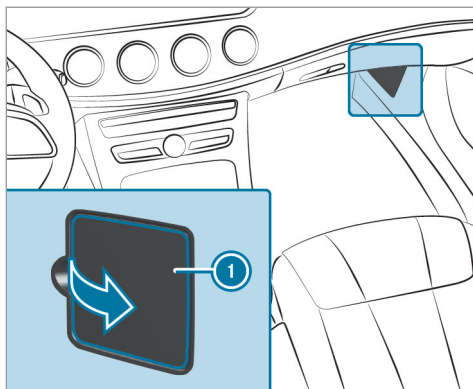

- ▶ Open cover ① in the direction of the arrow and remove it.

### Fuse box in the trunk

Observe the notes on electrical fuses  
(→ page 348).

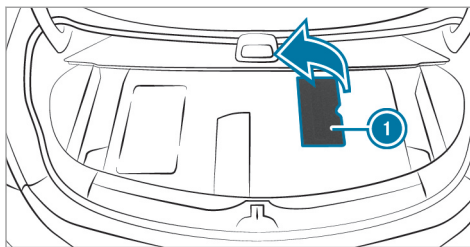

- ▶ Fold up cover ① in the direction of the arrow.

The fuse assignment diagram is in a recess on the side of the fuse box.

### Notes on noise or unusual handling characteristics

While driving, pay attention to vibrations, noises and unusual handling characteristics, e.g. pulling to one side. This may indicate that the wheels or tires are damaged. If you suspect that a tire is defective, reduce your speed immediately. Stop the vehicle as soon as possible to check the wheels and tires for damage. Hidden tire damage could also be causing the unusual handling characteristics. If you find no signs of damage, have the tires and wheels checked at a qualified specialist workshop.

### Regular checking of wheels and tires

**▲ WARNING** Risk of accident from damaged tires

Damaged tires can cause tire pressure loss. As a result, you could lose control of your vehicle.

▶ Check the tires regularly for signs of damage and replace any damaged tires immediately.

**▲ WARNING** Risk of aquaplaning due to insufficient tire tread

Insufficient tire tread will result in reduced tire grip. The tire tread is no longer able to dissipate water.

This means that in heavy rain or slush the risk of hydroplaning is increased, in particular if vehicle speed is not adapted to suit the conditions.

If the tire pressure is too high or too low, tires may exhibit different levels of wear at different locations on the tire contact surface.

▶ Thus, you should regularly check the tread depth and the condition of the tire contact surface across the entire width of all tires.

Minimum tread depth for:

- Summer tires:  $\frac{1}{8}$  in (3 mm)
- M+S tires:  $\frac{1}{6}$  in (4 mm)

▶ For safety reasons, replace the tires before the legally prescribed limit for the minimum tread depth is reached.

Carry out the following checks on all wheels regularly, at least once a month or as required, e.g. prior to a long journey or driving off-road:

- Check the tire pressure (→ page 354).
- Visual inspection of wheels and tires for damage.
- Check the valve caps.

The valves must be protected against moisture and dirt by the valve caps approved especially for your vehicle by Mercedes-Benz.

- Visual check of the tire tread depth and the tire contact surface condition across the entire width.

The minimum tread depth for summer tires is  $\frac{1}{8}$  in (3 mm) and for winter tires  $\frac{1}{4}$  in (4 mm).

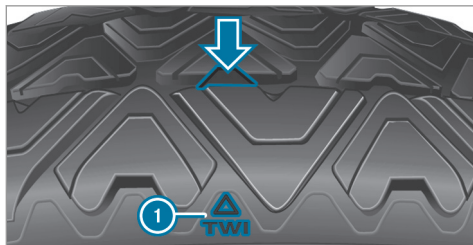

Six marks ① show where the bar indicators (arrow) are integrated into the tire tread. They are visible once a tread depth of approximately  $\frac{1}{16}$  in (1.6 mm) has been reached.

### Notes on snow chains

**⚠ WARNING** Risk of accident due to incorrect mounting of snow chains

If you have mounted snow chains to the front wheels, the snow chains may drag against the vehicle body or chassis components.

This could cause damage to the vehicle or the tires.

- ▶ Never mount snow chains on the front wheels.
- ▶ Only mount snow chains on the rear wheels in pairs.

**! NOTE** Damage to the wheel trim from mounted snow chains

If snow chains are mounted to steel wheels, the wheel trims can be damaged.

- ▶ Remove the wheel trims of steel wheels before mounting snow chains.

- Snow chains are only permissible for certain wheel/tire combinations. You can obtain

information about this from an authorized Mercedes-Benz Center.

- For safety reasons, only use snow chains that have been specifically approved for your vehicle by Mercedes-Benz, or snow chains with the same quality standard.
  - If snow chains are mounted, the maximum permissible speed is 30 mph (50 km/h).
  - **Vehicles with Active Parking Assist:** Do not use Active Parking Assist when snow chains are mounted.
  - **Vehicles with AIR BODY CONTROL:** Only drive at raised vehicle level when snow chains are mounted.
- ① You can deactivate ESP® to pull away (→ page 155). This allows the wheels to spin, achieving an increased driving force.

## Tire pressure

### Notes on tire pressure

**⚠ WARNING** Risk of accident due to insufficient or excessive tire pressure

Underinflated or overinflated tires pose the following risks:

- The tires may burst, especially as the load and vehicle speed increase.
  - The tires may wear excessively and/or unevenly, which may greatly impair tire traction.
  - The driving characteristics, as well as steering and braking, may be greatly impaired.
- Comply with the recommended tire pressure and check the tire pressure of all tires including the spare wheel regularly:
- at least once a month
  - when the load changes

- before embarking on a longer journey
  - if operating conditions change, e.g. off-road driving
- Adjust the tire pressure as necessary.

Driving with tire pressure that is too high or too low can:

- Shorten the service life of the tires.
- Cause increased tire damage.
- Adversely affect driving characteristics and thus driving safety, e.g. due to aquaplaning.

**⚠ WARNING** Risk of an accident due to insufficient tire pressure

Tires with pressure that is too low can overheat and burst as a result.

In addition, they also suffer from excessive and/or irregular wear, which can significantly impair the braking properties and the handling characteristics.

- Avoid excessively low tire pressures in all the tires, including the spare wheel.

Tire pressure which is too low can cause:

- Tire defects as a result of overheating
- Impaired handling characteristics
- Irregular wear
- Increased fuel consumption

**⚠ WARNING** Risk of accident from excessive tire pressure

Tires with excessively high pressure can burst because they are damaged more easily by highway fill, pot holes etc.

In addition, they also suffer from irregular wear, which can significantly impair the braking properties and the handling characteristics.

- Avoid excessively high tire pressures in all the tires, including the spare wheel.

Excessively high tire pressure can result in:

- Increased braking distance
- Impaired handling characteristics
- Irregular wear

- Impaired driving comfort
- Susceptibility to damage

**▲ WARNING** Risk of accident caused by repeated drop in tire pressure

If the tire pressure drops repeatedly, the wheel, valve or tire may be damaged.

Insufficient tire pressure can cause the tires to burst.

- ▶ Inspect the tire for signs of foreign objects.
- ▶ Check whether the wheel or valve has a leak.
- ▶ If you are unable to rectify the damage, contact a qualified specialist workshop.

You can find information on tire pressures for the vehicle's factory-installed tires on the following labels:

- Tire and Loading Information placard on the B-pillar of your vehicle (→ page 360).
- Tire pressure table on the inside of the fuel filler flap (→ page 355).

Observe the maximum tire pressure (→ page 367).

Use a suitable pressure gauge to check the tire pressure. The outer appearance of a tire does not permit any reliable conclusion about the tire pressure.

**Vehicles with a tire pressure monitoring system:** You can also check the tire pressure using the on-board computer.

Only correct tire pressures when the tires are cold. Conditions for cold tires:

- The vehicle has been parked with the tires out of direct sunlight for at least three hours.
- The vehicle has traveled less than 1 mile (1.6 km).

A rise in the tire temperature of 18 °F (10 °C) increases the tire pressure by approx. 10 kPa (0.1 bar/1.5 psi). Take this into account when checking the tire pressure of warm tires.

The tire pressures recommended for increased load/speed in the tire pressure table can affect the ride comfort.

**▲ WARNING** Risk of accident from unsuitable accessories on the tire valves

If you mount unsuitable accessories onto tire valves, the tire valves may be overloaded and malfunction, which can cause tire pressure loss. Tire pressure monitoring systems for retrofitting will cause the tire valve to remain open. This can also result in tire pressure loss.

- ▶ Only screw standard valve caps or valve caps specifically approved by Mercedes-Benz for your vehicle onto the tire valve.

### Tire pressure table

The tire pressure table is on the inside of the fuel filler flap.

- ① The data shown in the images is example data.

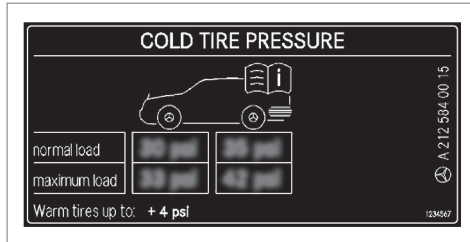

The tire pressure table shows the recommended tire pressure for all tires approved for this vehicle. The recommended tire pressures apply for cold tires under various operating conditions, i.e. loading and/or speed of the vehicle.

If one or more tire sizes precede a tire pressure, the tire pressure information following is only valid for those tire sizes.

The load conditions "partially laden" and "fully laden" are defined in the table for different numbers of passengers and amounts of luggage. The actual number of seats may differ from this.

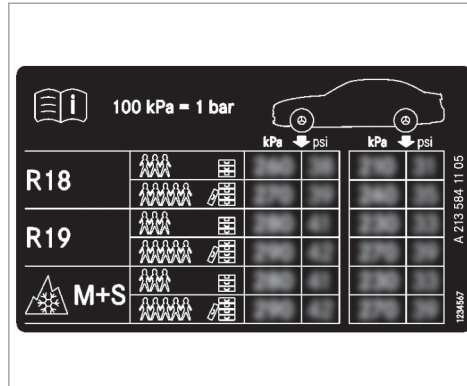

Some tire pressure tables only show the rim diameter instead of the complete tire size, e.g. **R18**. The rim diameter is part of the tire size and can be found on the tire side wall (→ page 368).

Be sure to also observe the following further related subjects:

- Notes on tire pressure (→ page 354)
- Tire and Loading Information placard (→ page 360)

- Maximum tire pressure (→ page 367)

### Checking tire pressures manually

- ▶ Read the tire pressure for the current operating conditions from the Tire and Loading Information placard or the tire pressure table. Observe the notes on tire pressure.
- ▶ Remove the valve cap of the tire to be checked.
- ▶ Press the tire pressure gauge securely onto the valve.
- ▶ Read the tire pressure.
- ▶ If the tire pressure is lower than the recommended value, increase the tire pressure to the recommended value.
- ▶ If the tire pressure is higher than the recommended value, release air. To do so, press down the metal pin in the valve, e.g. using the tip of a pen for example. Then check the tire pressure again using the tire pressure gauge.
- ▶ Screw the valve cap onto the valve.

Further related subjects:

- Notes on tire pressure (→ page 354)
- Tire pressure table (→ page 355)
- Tire and Loading Information placard (→ page 360)

### Tire pressure monitoring system

#### Function of the tire pressure monitoring system

**▲ DANGER** Risk of accident due to incorrect tire pressure

Every tire, including the spare (if provided), should be checked when cold at least once a month and inflated to the pressure recommended by the vehicle manufacturer (see Tire and Loading Information placard on the B-pillar on the driver's side or the tire pressure label on the inside of the fuel filler flap of your vehicle). If your vehicle has tires of a different size than the size indicated on the Tire and Loading Information placard or the

tire pressure table, you need to determine the proper tire pressure for those tires.

As an added safety feature, your vehicle has been equipped with a tire pressure monitoring system (TPMS) that illuminates a low tire pressure indicator lamp when one or more of your tires are significantly underinflated. Accordingly, if the low tire pressure indicator lamp lights up, you should stop and check your tires as soon as possible, and inflate them to the proper pressure. Driving on a significantly underinflated tire causes the tire to overheat and can lead to tire failure. Underinflation also increases fuel consumption and reduces tire tread life, and may affect the vehicle's handling and braking ability. Please note that the TPMS is not a substitute for proper tire maintenance, and it is the driver's responsibility to maintain correct tire pressure, even if underinflation has not reached the level to trigger illumination of the TPMS low tire pressure indicator lamp.

Your vehicle has also been equipped with a TPMS malfunction indicator to indicate when

the system is not operating properly. The TPMS malfunction indicator is combined with the low tire pressure indicator lamp. When the system detects a malfunction, the indicator lamp will flash for approximately a minute and then remain continuously illuminated. This sequence will continue upon subsequent vehicle start-ups as long as the malfunction exists.

When the malfunction indicator is illuminated, the system may not be able to detect or signal low tire pressure as intended. TPMS malfunctions may occur for a variety of reasons, including the installation of incompatible replacement or alternate tires or wheels on the vehicle that prevent the TPMS from functioning properly.

Always check the TPMS malfunction warning lamp after replacing one or more tires or wheels on your vehicle to ensure that the replacement or alternate tires and wheels allow the TPMS to continue to function properly.

The system checks the tire pressure and the tire temperature of the tires fitted to the vehicle by means of a tire pressure sensor.

New tire pressure sensors, e.g. in winter tires, are automatically taught-in the first time they are driven.

The tire pressure and the tire temperature appear in the multifunction display (→ page 202).

If there is a substantial pressure loss or if the tire temperature is excessive, a warning will be given:

- Via display messages (→ page 425).
- Via the  warning lamp in the instrument cluster (→ page 459).

It is the driver's responsibility to set the tire pressure to the recommended cold tire pressure suitable for the operating situation. Set the tire pressure for cold tires using a tire pressure gauge. Note that the correct tire pressure for the current operating situation must first be taught-in to the tire pressure monitoring system.

In most cases, the tire pressure monitoring system will automatically update the new reference values after you have changed the tire pressure. You can, however, also update the reference values by restarting the tire pressure monitoring system manually (→ page 359).

### System limitations

The system may be impaired or may not function in the following situations:

- If the tire pressure is set incorrectly.
- If there is a sudden pressure loss caused, for example, by a foreign object penetrating the tire.
- If there is a malfunction caused by another radio signal source.

Make sure to observe the following further related subject:

- Notes on tire pressure (→ page 354)

### Checking the tire pressure with the tire pressure monitoring system

#### Requirement:

- The ignition is switched on.

On-board computer:

➔ [Service](#) ➔ [Tires](#)

One of the following displays appears:

- Current tire pressure and tire temperature of the individual wheels:

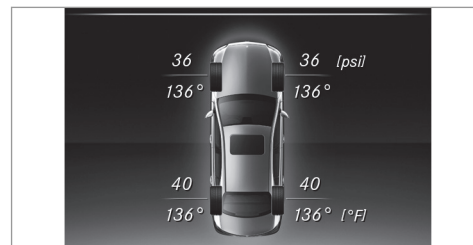

- **Tire pressure will be displayed after driving a few minutes**
  - **Tire Pressure Monitor Active:** the teach-in process of the system is not yet complete. The tire pressures are already being monitored.
- ▶ Compare the tire pressure with the recommended tire pressure for the current operation.



ing status (→ page 355). Observe the notes on tire temperature (→ page 354).

- ① The values displayed in the multifunction display may deviate from those of the tire pressure gauge as they refer to sea level. At high altitudes, the tire pressure values indicated by pressure gauges are higher than those shown by the on-board computer. In this case, do not reduce the tire pressure.

Make sure to observe the following further related subject:

- Notes on tire pressure (→ page 354)

### Restarting the tire pressure monitoring system

#### Requirement:

- The recommended tire pressure is correctly set for the respective operating condition on each of the four wheels (→ page 354).

Restart the tire pressure monitoring system in the following situations:

- The tire pressure has changed.

- The wheels or tires have been changed or newly installed.

On-board computer:

→ Service → Tires

- ▶ Swipe downwards on the Touch Control on the left-hand side of the steering wheel. The **Use Current Pressures as New Reference Values** message is shown in the multifunction display.
- ▶ Press **OK** to confirm the restart. The **Tire Press. Monitor Restarted** message is shown in the multifunction display. Current warning messages are deleted and the **(U)** yellow warning lamp goes out. After you have driven for a few minutes, the system checks whether the current tire pressures are within the specified range. The current tire pressures are then accepted as reference values and monitored.

Make sure to observe the following further related subject:

- Notes on tire pressure (→ page 354)

### Radio-equipment approval of the tire pressure monitoring system

#### Radio equipment approval numbers

Country	Radio equipment approval number
Canada	FCC ID: MRXAG5SP4
USA	FCC ID: MRXMFR IC: 2546A-AG5SP4

Further information on the declaration of conformity for wireless vehicle components (→ page 23).

#### Tire pressure loss warning system

##### Function of the tire pressure loss warning system

The tire pressure loss warning system warns the driver by means of display messages when there is a severe tire pressure loss.

After a change in tire pressure, a wheel rotation or a wheel change, the tire pressure loss warn-

ing system has to be taught-in again by being restarted (→ page 360).

The tire pressure loss warning system does not replace the need to regularly check the tire pressures.

### System limitations

The system may be impaired or may not function in the following situations:

- If the tire pressure is set incorrectly.
- If there is a sudden pressure loss caused, for example, by a foreign object penetrating the tire.
- If the pressure loss in several tires decreases at the same rate.

The system has a limited or delayed function:

- When the road surface is poor, e.g. snow or gravel.
- When driving with snow chains.
- When driving in a very sporty driving style with high cornering speeds or sudden acceleration.
- When driving with a high load.

Be sure to also observe the following further related subjects:

- Notes on tire pressure (→ page 354)
- Display messages about the tires (→ page 425)

### Restarting the tire pressure loss warning system

#### Requirement:

- The recommended tire pressure is correctly set for the respective operating condition on each of the four wheels (→ page 354).

On-board computer:

↳ Service ▶▶ Tires

The **Run Flat Indicator Active** Press 'OK' to **Restart** message is shown in the multifunction display.

Restart the tire pressure loss warning system in the following situations:

- The tire pressure has changed.
- The wheels or tires have been changed or newly installed.

- ▶ Press **[OK]** to begin the new start. The **Tire Pressure Now OK?** message is shown in the multifunction display.
- ▶ Select **Yes**.
- ▶ Press **[OK]** to confirm the restart. The **Run Flat Indicator Restarted** message is shown in the multifunction display. After you have driven for a few minutes, the tire pressure loss warning system monitors the set tire pressures of all the tires.

Be sure to also observe the following further related subjects:

- Notes on tire pressure (→ page 354)

### Loading the vehicle

#### Tire and Loading Information placard

**⚠ WARNING** Risk of accident from overloaded tires

Overloaded tires may overheat and burst as a consequence. Overloaded tires can also

impair the steering and handling characteristics and lead to brake failure.

- ▶ Observe the load rating of the tires.
- ▶ The load rating must be at least half the permissible axle load of the vehicle.
- ▶ Never overload the tires by exceeding the maximum load.

The Tire and Loading Information placard is on the B-pillar on the driver's side of the vehicle.

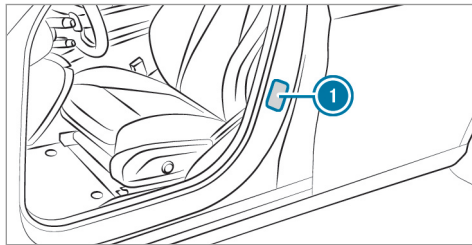

1 Tire and Loading Information placard

TIRE AND LOADING INFORMATION		RENSEIGNEMENTS SUR LES PNEUS ET LE CHARGEMENT	
SEATING CAPACITY NOMBRE DE PLACES	TOTAL 7	FRONT AVANT 2	MIDDLE MILIEU 3
		REAR ARRIERE 2	
The combined weight of occupants and cargo should never exceed XXX kg or XXX lbs. Le poids total des occupants et du chargement ne doit jamais dépasser XXX kg ou XXX lbs.			
TIRE PNEU	SIZE DIMENSIONS	COLD TIRE PRESSURE PRESSION DES PNEUS A FROID	SEE OWNER'S MANUAL FOR ADDITIONAL INFORMATION
FRONT AVANT	265/40 ZR18 99Y XL	200 KPA, 29 PSI	VOIR LE MANUEL DE L'USAGER POUR PLUS DE RENSEIGNEMENTS
REAR ARRIERE	285/35 ZR18 101Y XL	200 KPA, 29 PSI	
SPARE DE SECOURS	175/55-18 95P	420 KPA, 60 PSI	

i The data shown in the image is example data.

The Tire and Loading Information placard shows:

- Maximum number of seats 2 according to the maximum number of people permitted to travel in the vehicle.
- Maximum permissible load 3 comprises the gross weight of all vehicle occupants, load and luggage.

- Recommended tire pressures 1 for cold tires. The recommended tire pressures are valid for the maximum permissible load and up to the maximum permissible vehicle speed.

Please also note:

- Information on permissible weights and loads on the vehicle identification plate (→ page 385).
- Information on tire pressure on the tire pressure table (→ page 355).

Further related subjects:

- Determining the maximum permissible load (→ page 361)
- Notes on tire pressure (→ page 354)

### Determining the maximum permissible load

The following steps have been developed as required of all manufacturers under Title 49, Code of U.S. Federal Regulations, Part 575, pursuant to the "National Traffic and Motor Vehicle Safety Act of 1966".

- ▶ **Step 1:** locate the statement "The combined weight of occupants and cargo should never exceed XXX kg or XXX lbs." ("The combined weight of occupants and cargo should never exceed XXX kg or XXX lbs.") on your vehicle's Tire and Loading Information placard.
- ▶ **Step 2:** determine the combined weight of the driver and passengers that will be traveling in your vehicle.
- ▶ **Step 3:** subtract the combined weight of the driver and passengers from XXX kg or XXX lbs.
- ▶ **Step 4:** the resulting figure equals the permissible cargo and luggage load capacity. For example: If "XXX" equals 1400 lbs and there are five occupants in your vehicle with a weight of 150 lbs each, the maximum cargo and luggage load capacity is 650 lbs ( $1400 - 750 (5 \times 150) = 650$  lbs).
- ▶ **Step 5:** determine the combined weight of luggage and cargo that the vehicle will be carrying. For safety reasons, this weight may not safely exceed the available cargo and luggage load capacity calculated in step 4.

Even if you have calculated the total load carefully, you should still make sure that the maximum permissible gross mass and the maximum permissible axle load of your vehicle are not exceeded. Details can be found on the vehicle identification plate.

- ▶ Have your loaded vehicle – including driver, occupants and load – weighed on a vehicle weighbridge.  
The measured values may not exceed the maximum permissible values stated on the vehicle identification plate.

Further related subjects:

- Calculation example for determining the maximum load (→ page 362)
- Tire and Loading Information placard (→ page 360)
- Tire pressure table (→ page 355)
- Vehicle identification plate

### Calculation example for determining the maximum load

---

The following table shows examples of how to calculate total and load capacities with varying seating configurations and different numbers and sizes of occupants. The following examples use a maximum load of 1500 lbs (680 kg). **This is for illustration purposes only.** Make sure you are using the actual load limit for your vehicle stated on your vehicle's Tire and Loading Information placard (→ page 360).

The higher the weight of all the occupants, the smaller the maximum load for luggage.

**Step 1**

	Example 1	Example 2
Combined maximum weight of occupants and load (data from the Tire and Loading Information placard)	1500 lbs (680 kg)	1500 lbs (680 kg)

**Step 2**

	Example 1	Example 2
Number of people in the vehicle (driver and occupants)	5	1
Distribution of the occupants	Front: 2 Rear: 3	Front: 1
Weight of occupants	Occupant 1: 150 lbs (68 kg) Occupant 2: 180 lbs (82 kg) Occupant 3: 160 lbs (73 kg) Occupant 4: 140 lbs (63 kg) Occupant 5: 120 lbs (54 kg)	Occupant 1: 200 lbs (91 kg)
Total weight of all occupants	750 lbs (340 kg)	200 lbs (91 kg)

**Step 3**

	<b>Example 1</b>	<b>Example 2</b>
Permissible load (maximum gross vehicle weight rating from the Tire and Loading Information placard minus the gross weight of all occupants)	1500 lbs (680 kg) - 750 lbs (340 kg) = 750 lbs (340 kg)	1500 lbs (680 kg) - 200 lbs (91 kg) = 1300 lbs (589 kg)

## Tire labeling

### Overview of tire labeling

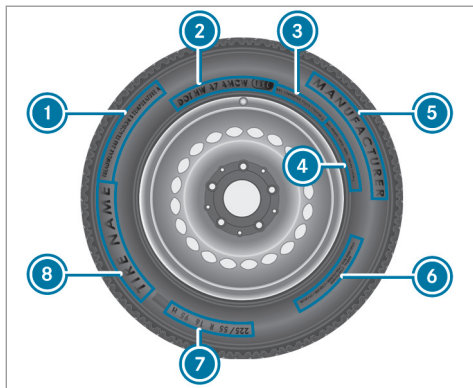

- ① Uniform Tire Quality Grading Standard (→ page 365)
- ② DOT, Tire Identification Number (→ page 366)
- ③ Maximum tire load (→ page 367)
- ④ Maximum tire pressure (→ page 367)

- ⑤ Manufacturer
  - ⑥ Characteristics of the tire (→ page 368)
  - ⑦ Tire size designation, load-bearing capacity, speed rating and load index (→ page 368)
  - ⑧ Tire name
- ① The data shown in the image is example data.

### Tire Quality Grading

In accordance with the US Department of Transportation's "Uniform Tire Quality Grading Standards", tire manufacturers are required to grade their tires on the basis of the following three performance factors:

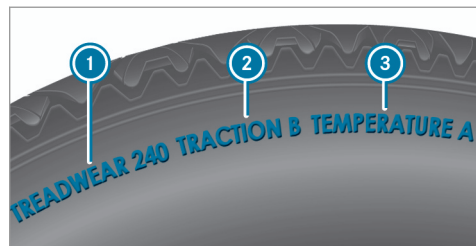

- ① Tread wear grade
  - ② Traction grade
  - ③ Temperature grade
- ① The data shown in the image is example data.
- ① The classification is not legally stipulated for Canada, but it is generally stated.

### Tread wear grade

The tread wear grade is a comparative rating based on the wear rate of the tire when tested under controlled conditions on a specified test track of the US Department of Transportation. For example, a tire graded 150 would wear one

and one-half times as well on the government test track as a tire graded 100.

The relative performance of tires depends upon the actual conditions of their use, however, and may depart significantly from the norm due to variations in driving habits, service practices and differences in road characteristics and climate conditions.

### Traction grade

**⚠ DANGER** Risk of accident due to inadequate traction

The traction grade assigned to this tire is based on straight-ahead braking traction tests, and does not include either acceleration, cornering, hydroplaning or peak traction characteristics.

- ▶ Always adapt your driving style and drive at a speed to suit the prevailing traffic and weather conditions.

**!** **NOTE** Damage to the drivetrain from wheelspin

- ▶ Avoid wheelspin.

The traction grades – from highest to lowest – are AA, A, B and C. Those grades represent the tire's ability to stop on wet pavement as measured under controlled conditions on specified government test surfaces made of asphalt and concrete.

### Temperature grade

**⚠ WARNING** Risk of accident from tire overheating and tire failure

The temperature grade for this tire is established for a tire that is properly inflated and not overloaded. Excessive speed, underinflation, or excessive loading, either separately or in combination, can cause excessive heat build-up and possible tire failure.

- ▶ Observe the recommended tire pressures and regularly check the tire pres-

sure of all tires including the spare wheel.

- ▶ Adjust the tire pressure as necessary.

The temperature grades are A (the highest), B and C. They represent the tire's resistance to the generation of heat and its ability to dissipate heat when tested under controlled conditions on a specified indoor laboratory test wheel. Sustained high temperature can cause the material of the tire to degenerate and reduce tire life, and excessive temperature can lead to sudden tire failure. Grade C corresponds to a level of performance which all passenger car tires must meet under the requirements of the US Department of Transportation.

### DOT, Tire Identification Number (TIN)

US tire regulations stipulate that every tire manufacturer or retreader must imprint a TIN in or on the side wall of each tire produced.



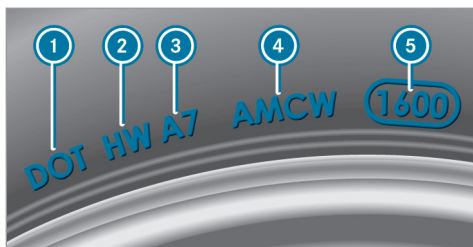

**i** The data shown in the image is example data.

The TIN is a unique identification number to identify tires and comprises the following:

- **DOT (Department of Transportation):** tire symbol marks **1** indicating that the tire complies with the requirements of the US Department of Transportation.
- **Manufacturer identification code:** manufacturer identification code **2** contains details of the tire manufacturer. New tires have a code with two symbols. Retreaded tires have a code with four symbols. Further information on retreaded tires (→ page 373).

- **Tire size:** identifier **3** describes the tire size.
- **Tire type code:** tire type code **4** can be used by the manufacturer as a code to describe specific characteristics of the tire.
- **Manufacturing date:** manufacturing date **5** provides information about the age of a tire. The 1st and 2nd positions represent the calendar week and the 3rd and 4th positions state the year of manufacture (e.g. "3208" represents the 32nd week of 2008).

#### Information on the maximum tire load



**i** The data shown in the image is example data.

Maximum tire load **1** is the maximum permissible weight for which the tire is approved.

Do not overload the tires by exceeding the specified load limit. The maximum permissible load can be found on the vehicle's Tire and Loading Information placard on the B-pillar on the driver's side (→ page 360).

#### Specifications for maximum tire pressure

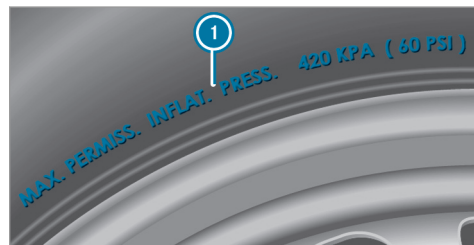

**i** The data shown in the image is example data.

Never exceed maximum tire pressure ❶ specified for the tire.

### Information on tire characteristics



❶ The data shown in the image is example data.

This information describes the type of tire cord and the number of layers in side wall ❶ and under tire tread ❷.

### Tire size designation, load-bearing capacity, speed rating and load index

**⚠ WARNING** Risk of injury through exceeding the specified tire load rating or the permissible speed rating

Exceeding the specified tire load rating or the permissible speed rating may lead to tire damage and to the tires bursting.

- ▶ Therefore, only use tire types and sizes approved for your vehicle model.
- ▶ Observe the tire load rating and speed rating required for your vehicle.

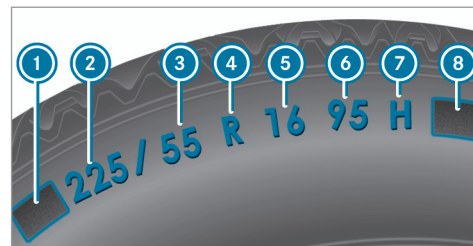

- ❶ Preceding letter
- ❷ Nominal tire width in millimeters
- ❸ Aspect ratio in %
- ❹ Tire code
- ❺ Rim diameter
- ❻ Load-bearing index
- ❼ Speed rating
- ❽ Load index

❶ The data shown in the image is example data.

Information about reading tire data can be obtained from any qualified specialist workshop.

**Preceding letter 1:**

- Without: passenger vehicle tires according to European manufacturing standards.
- "P": passenger vehicle tires according to US manufacturing standards.
- "LT": light truck tires according to US manufacturing standards.
- "T": compact emergency spare wheels with high tire pressure that are only designed for temporary use in an emergency.

**Aspect ratio 2:**

Ratio between tire height and tire width in percent (tire height divided by tire width).

**Tire code 3 (tire type):**

- "R": radial tire
- "D": bias ply tire
- "B": bias belted tires
- "ZR": radial tire with a maximum speed above 149 mph (240 km/h) (optional)

**Rim diameter 5:**

The diameter of the bead seat (not the diameter of the rim flange). The rim diameter is specified in inches (in).

**Load-bearing index 6:**

Numerical code that specifies the maximum load-bearing capacity of a tire (e.g. "91" corresponds to 1356 lbs (615 kg)).

The load-bearing capacity of the tire must be at least half the permissible axle load of your vehicle. Do not overload the tires by exceeding the specified load limit.

See also:

- Maximum permissible load on the Tire and Loading Information placard (→ page 360)
- Maximum tire load (→ page 367)
- Load index

**Speed rating 7:**

Specifies the approved maximum speed of the tire.

- **i** An electronic speed limiter prevents your vehicle from exceeding a speed of 130 mph (210 km/h).

Make sure that your tires have the required speed rating. You can obtain information on the required speed rating from an authorized Mercedes-Benz Center.

**Summer tires**

Index	Speed rating
Q	up to 100 mph (160 km/h)
R	up to 106 mph (170 km/h)
S	up to 112 mph (180 km/h)
T	up to 118 mph (190 km/h)
H	up to 130 mph (210 km/h)
V	up to 149 mph (240 km/h)
W	up to 168 mph (270 km/h)
Y	up to 186 mph (300 km/h)

Index	Speed rating
ZR...Y <sup>1</sup>	up to 186 mph (300 km/h)
ZR...(..Y) <sup>1</sup>	over 186 mph (300 km/h)
ZR <sup>1</sup>	over 149 mph (240 km/h)

- Specifying the speed rating as the "ZR" index in tire code ④ is optional for tires up to 186 mph (300 km/h).
- If your tire code ④ includes "ZR" and there is no speed rating ⑦, find out what the maximum speed is from the tire manufacturer.
- If load-bearing index ⑥ and speed rating ⑦ are in brackets, the maximum speed rating of your tire is above 186 mph (300 km/h). To find out the maximum speed, ask the tire manufacturer.

<sup>1</sup> "ZR" stated in the tire code.

<sup>2</sup> Or "M+S"  " for winter tires

### All-weather tires and winter tires

Index	Speed rating
Q M+S <sup>2</sup>	up to 100 mph (160 km/h)
T M+S <sup>2</sup>	up to 118 mph (190 km/h)
H M+S <sup>2</sup>	up to 130 mph (210 km/h)
V M+S <sup>2</sup>	up to 149 mph (240 km/h)

Winter tires bear the  snowflake symbol and fulfill the requirements of the Rubber Manufacturers Association (RMA) and the Rubber Association of Canada (RAC) regarding the tire traction on snow.

### Load index ⑧:

- No specification given: standard load (SL) tire
- "XL" or "Extra Load": extra load tire or reinforced tire
- "Light Load": light load tire

- "C", "D", "E": a load range that depends on the maximum load that the tire can carry at a certain pressure

### Definition of terms for tires and loading

**Tire structure and characteristics:** describes the number of layers or the number of rubber-coated belts in the tire contact surface and the tire wall. These are made of steel, nylon, polyester and other materials.

**Bar:** metric unit for tire pressure.

14.5038 pounds per square inch (psi) and 100 kilopascal (kPa) is the equivalent of one bar.

**DOT (Department of Transportation):** DOT-marked tires fulfill the requirements of the US Department of Transportation.

**Average weight of the vehicle occupants:** the number of vehicle occupants for which the vehicle is designed, multiplied by 150 lb (68 kg).

**Uniform Tire Quality Grading Standards:** a uniform standard to grade the quality of tires with regard to tread quality, tire traction and temperature characteristics. The quality grading assessment is made by the manufacturer following specifications from the U.S. government. The quality grade of a tire is imprinted on the side wall of the tire.

**Recommended tire pressure:** the recommended tire pressure is the tire pressure specified for the tires mounted to the vehicle at the factory.

The tire and information table contains the recommended tire pressures for cold tires, the maximum permissible load and the maximum permissible vehicle speed.

The tire pressure table contains the recommended tire pressures for cold tires under various operating conditions, i.e. loading and/or speed of the vehicle.

**Increased vehicle weight due to optional equipment:** the combined weight of all standard and optional equipment available for the vehicle,

regardless of whether it is actually installed on the vehicle or not.

**Rim:** the part of the wheel on which the tire is installed.

**GAWR (Gross Axle Weight Rating):** the GAWR is the maximum permissible axle load. The actual load on an axle must never exceed the gross axle weight rating. The gross axle weight rating can be found on the vehicle identification plate on the B-pillar on the driver's side.

**Speed rating:** the speed rating is part of the tire identification. It specifies the speed range for which a tire is approved.

**GVW (Gross Vehicle Weight):** the gross vehicle weight comprises the weight of the vehicle including fuel, tools, the spare wheel, accessories installed, occupants, luggage and the trailer drawbar noseweight, if applicable. The gross vehicle weight must not exceed the gross vehicle weight rating GVWR as specified on the vehicle identification plate on the B-pillar on the driver's side.

**GVWR (Gross Vehicle Weight Rating):** the GVWR is the maximum permitted gross weight

of the fully laden vehicle (weight of the vehicle including all accessories, occupants, fuel, luggage and the trailer drawbar noseweight if applicable). The gross vehicle weight rating is specified on the vehicle identification plate on the B-pillar on the driver's side.

**Maximum weight of the laden vehicle:** the maximum weight is the sum of the curb weight of the vehicle, the weight of the accessories, the maximum load and the weight of optional equipment installed at the factory.

**Kilopascal (kPa):** metric unit for tire pressure. 6.9 kPa corresponds to 1 psi. Another unit for tire pressure is bar. 100 kilopascal (kPa) equals 1 bar.

**Load index:** in addition to the load-bearing index, the load index may also be imprinted on the side wall of the tire. This specifies the load-bearing capacity of the tire more precisely.

**Curb weight:** the weight of a vehicle with standard equipment including the maximum capacity of fuel, oil and coolant. It also includes the air conditioning system and optional equipment if

these are installed on the vehicle, but does not include passengers or luggage.

**Maximum tire load:** the maximum tire load is the maximum permissible weight in kilograms or lbs for which a tire is approved.

**Maximum permissible tire pressure:** maximum permissible tire pressure for one tire.

**Maximum load on one tire:** maximum load on one tire. This is calculated by dividing the maximum axle load of one axle by two.

**PSI (pounds per square inch):** standard unit of measurement for tire pressure.

**Aspect ratio:** ratio between tire height and tire width in percent.

**Tire pressure:** pressure inside the tire applying an outward force to every square inch of the tire. The tire pressure is specified in pounds per square inch (psi), in kilopascals (kPa) or in bar. The tire pressure should only be corrected when the tires are cold.

**Cold tire pressure:** the tires are cold when the vehicle has been parked for at least 3 hours

without direct sunlight on the tires or the vehicle has been driven for less than 1 mile (1.6 km).

**Tire contact surface:** the part of the tire that comes into contact with the road.

**Tire bead:** the purpose of the tire bead is to ensure that the tire sits securely on the wheel rim. There are several wire cores in the tire bead to prevent the tire from changing length on the wheel rim.

**Side wall:** the part of the tire between the tread and the tire bead.

**Weight of optional equipment:** the combined weight of the optional equipment weighing more than the replaced standard parts and more than 5 lbs (2.3 kg). This optional equipment, such as high-performance brakes, level control system, a roof luggage rack or high-performance batteries, is not included in the curb weight and the weight of the accessories.

**TIN (Tire Identification Number):** a unique identification number which can be used by a tire manufacturer to identify tires, for example, in a product recall, and thus identify the purchasers. The TIN is made up of the manufactur-

er's identity code, tire size, tire type code and the manufacturing date.

**Load-bearing index:** the load-bearing index is a code that contains the maximum load-bearing capacity of a tire.

**Traction:** traction is the grip resulting from friction between the tires and the road surface.

**Wear indicator:** narrow bars (tread wear bars) that are distributed over the tire contact surface. If the tire tread is level with the bars, the wear limit of 1/16 in (1.6 mm) has been reached.

**Distribution of vehicle occupants:** distribution of vehicle occupants over designated seat positions in a vehicle.

**Maximum permissible payload weight:** nominal load and luggage load plus 150 lb (68 kg) multiplied by the number of seats in the vehicle.

## Changing a wheel

### Notes on selecting, installing and replacing tires

You can ask for information regarding permitted wheel/tire combinations at an authorized Mercedes-Benz Center.

**⚠ WARNING** Risk of accident due to incorrect dimensions of wheels and tires

If wheels and tires of the wrong size are installed, the wheel brakes or wheel suspension components may be damaged.

- ▶ Always replace wheels and tires with those that fulfill the specifications of the original part.

When replacing wheels, make sure to fit the correct:

- Designation
- Model

When replacing tires, make sure to install the correct:

- Designation
- Manufacturer
- Model

**⚠ WARNING** Risk of injury through exceeding the specified tire load rating or the permissible speed rating

Exceeding the specified tire load rating or the permissible speed rating may lead to tire damage and to the tires bursting.

- ▶ Therefore, only use tire types and sizes approved for your vehicle model.
- ▶ Observe the tire load rating and speed rating required for your vehicle.

**!** **NOTE** Damage to vehicle and tires due to non-approved tire types and sizes

For safety reasons, only use wheels, tires and accessories which have been approved for your vehicle by Mercedes-Benz.

These tires have been specially adapted for use with the control systems, e.g. ABS or ESP<sup>®</sup>, and are marked as follows:

- MO = Mercedes-Benz Original
- MOE = Mercedes-Benz Original Extended (run-flat tires only for certain wheels)
- MO1 = Mercedes-Benz Original (only certain AMG tires)

Certain characteristics, e.g. handling, vehicle noise emissions or fuel consumption, may otherwise be adversely affected. In addition, when driving with a load, tire dimension variations could cause the tires to come into contact with the body and axle components. This could result in damage to the tires or the vehicle.

Only use tires, wheels or accessories tested and approved by Mercedes-Benz.

**!** **NOTE** Risk to driving safety from retreaded tires

Retreaded tires are neither tested nor recommended by Mercedes-Benz, since previous damage cannot always be detected on retreaded tires.

For this reason driving safety cannot be guaranteed.

- ▶ Do not use used tires if you have no information about their previous usage.

**!** **NOTE** Possible damage to wheels or tires when driving over obstacles

Large wheels have a lower tire section width. The lower the tire section width, the greater is the risk of damage to wheels or tires when driving over obstacles.

- ▶ Avoid obstacles or drive particularly carefully.

**!** **NOTE** Damage to electronic component parts from the use of tire-mounting tools

**Vehicles with a tire pressure monitoring system:** Electronic component parts are located in the wheel. Tire-mounting tools should not be used in the area of the valve.

This could otherwise damage the electronic component parts.

- ▶ Have the tires changed at a qualified specialist workshop only.

**!** **NOTE** Damage to summer tires at low ambient temperatures

Using summer tires at very low ambient temperatures can cause cracks to form, thereby damaging the tires permanently.

- ▶ At temperatures below 45 °F (7 °C) use M+S tires.

Accessory parts that are not approved for your vehicle by Mercedes-Benz or are not being used correctly can impair the operating safety.

Before purchasing and using non-approved accessories, visit a qualified specialist workshop and enquire about:

- Suitability
- Legal stipulations
- Factory recommendations

**!** **WARNING** Risk of accident with high performance tires

The special tire tread in combination with the optimized tire compound means that the risk of skidding or hydroplaning on wet roads is increased.

In addition, the tire grip is greatly reduced at a low outside temperature and tire running temperature.

- ▶ Switch on the ESP® and adapt your driving style accordingly.
- ▶ Use M+S tire at outside temperatures of less than 10 °C (50 °F).



Observe the following when selecting, installing and replacing tires:

- Only use tires and wheels of the same type (summer tires, winter tires, MOExtended tires) and the same make.
- Only install wheels of the same size on one axle (left and right).  
It is only permissible to install a different wheel size in the event of a flat tire in order to drive to the specialist workshop.
- Only install tires of the correct size onto the wheels.
- **Vehicles with a tire pressure monitoring system:** all mounted wheels must be equipped with functioning sensors for the tire pressure monitoring system.
- At temperatures below 45 °F (7 °C), use winter tires or all-season tires marked M+S for all wheels.

Winter tires bearing the  snowflake symbol in addition to the M+S marking provide the best possible grip in wintry road conditions.

- For M+S tires, only use tires with the same tread.
- Observe the maximum permissible speed for the M+S tires installed.  
If this is below the vehicle's maximum speed, this must be indicated in an appropriate label in the driver's field of vision.
- Run in new tires at moderate speeds for the first 60 miles (100 km).
- Replace the tires after six years at the latest, regardless of wear.
- **When replacing with tires that do not feature run-flat characteristics:** vehicles with MOExtended tires are not equipped with a TIREFIT kit at the factory. Equip the vehicle with a TIREFIT kit after replacing with tires that do not feature run-flat characteristics, e.g. winter tires.

For more information on wheels and tires, contact a qualified specialist workshop.

Be sure to also observe the following further related subjects:

- Notes on tire pressure (→ page 354)

- Tire and Loading Information placard (→ page 360)
- Tire size designation, load-bearing capacity, speed rating and load index (→ page 368)
- Tire pressure table (→ page 355)

### Notes on rotating wheels

 **WARNING** Risk of injury through different wheel sizes

Interchanging the front and rear wheels if the wheels or tires have different dimensions may severely impair the driving characteristics.

The wheel brakes or wheel suspension components may also be damaged.

- ▶ Rotate front and rear wheels only if the wheels and tires are of the same dimensions.

The wear patterns on the front and rear wheels differ:

- Front wheels wear more on the shoulder of the tire
- Rear wheels wear more in the center of the tire

On vehicles that have the same size front and rear wheels, rotate the wheels according to the intervals in the tire manufacturer's warranty book in your vehicle documents. If this is not available, rotate the tires every 3,000 to 6,000 miles (5,000 to 10,000 km), depending on the wear. Ensure that the direction of rotation is maintained.

It is imperative to observe the instructions and safety notes on "Wheel change" when doing so.

### Notes on storing wheels

- After removing wheels, store them in a cool, dry and preferably dark place.
- Protect the tires from contact with oil, grease or fuel.

### Overview of the tire-change tool kit

Apart from some country-specific variants, vehicles are not equipped with a tire-change tool kit. For more information on which tire-changing tools are required and approved for performing a wheel change on your vehicle, consult a qualified specialist workshop.

Necessary tire-changing tools may include, for example:

- Jack
- Chock
- Wheel wrench
- Centering pin

The tire-change tool kit is located in tool bag ①.

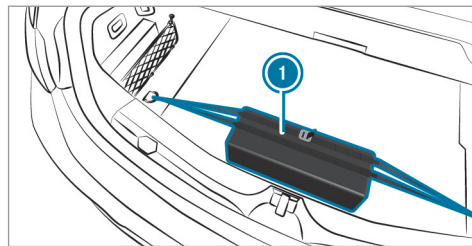

#### ① Tool bag

Tool bag ① contains:

- Jack
- Gloves
- Wheel wrench
- Centering pin
- Folding wheel chock
- Ratchet for jack

### Setting up the folding wheel chock

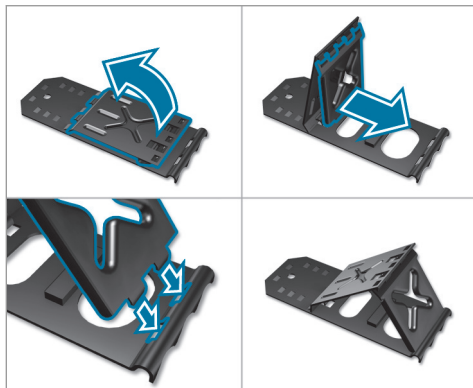

### Preparing the vehicle for a wheel change

#### Requirements

- The required tire-change tool kit is available. If your vehicle is not equipped with the tire-change tool kit, consult a qualified specialist workshop to find out about suitable tools.

- The vehicle is not on a slope.
- The vehicle is on solid, non-slippery and level ground.

- ▶ Apply the electric parking brake manually.
- ▶ Move the front wheels to the straight-ahead position.
- ▶ **Vehicles with automatic transmission:** shift into position **P**.
- ▶ **Vehicles with AIR BODY CONTROL:** set the normal vehicle level (→ page 173).
- ▶ Switch off the engine.
- ▶ Make sure that the engine cannot be started.
- ▶ Place chocks or other suitable items under the front and rear of the wheel that is diagonally opposite the wheel you wish to change.
- ▶ Remove the hub caps if necessary (→ page 377).
- ▶ Raising the vehicle (→ page 378).

### Removing and installing hub caps

#### Requirement:

- The vehicle is prepared for a wheel change (→ page 377).

#### Plastic hub cap

- ▶ **To remove:** turn the center cover of the hub cap anti-clockwise and remove the hub cap.
- ▶ **To install:** make sure that the center cover of the hub cap is turned anti-clockwise.
- ▶ Position the hub cap and turn the center cover clockwise until the hub cap engages physically and audibly.

### Aluminum hub cap

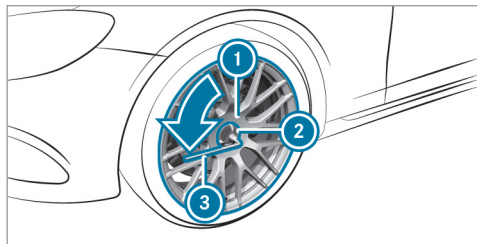

▶ **To remove:** position socket ② on hub cap ①.

① The socket can be found in the tire-change tool kit.

▶ Position wheel spanner ③ on socket ②.

▶ Using wheel spanner ③, turn hub cap ① counter-clockwise and remove it.

▶ **To install:** position hub cap ① and turn until it is completely flush with the wheel.

▶ Position socket ② on hub cap ①.

▶ Attach wheel spanner ③ to socket ② and tighten the hub cap clockwise.

**Specified tightening torque:** 18 lb-ft (25 Nm).

▶ Raise the vehicle (→ page 378).

### Raising the vehicle when changing a wheel

#### Requirements:

- There are no persons in the vehicle.
- The vehicle has been prepared for a wheel change (→ page 377).
- The hub caps have been removed (→ page 377).

#### Important notes on using the jack:

- only use the vehicle-specific jack that has been tested and approved by Mercedes-Benz to raise the vehicle.
- the jack is only designed for raising and holding the vehicle for a short time while a wheel is being changed and not for maintenance work under the vehicle.

- the jack must be placed on a firm, flat and non-slip surface. If necessary, use a large, load-bearing, non-slip underlay.
- the foot of the jack must be positioned vertically under the jack support point.

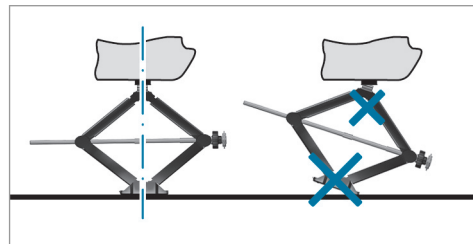

#### Rules of conduct when the vehicle is raised:

- Never place your hands or feet under the vehicle.
- Do not lie under the vehicle.
- Do not start the engine and do not release the electric parking brake.
- Do not open or close any doors or the trunk lid.

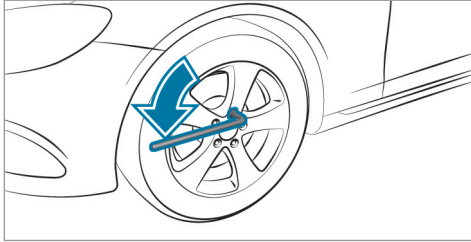

- ▶ Using the wheel wrench, loosen the wheel bolts on the wheel you wish to change by about one full turn. Do not unscrew the bolts completely.

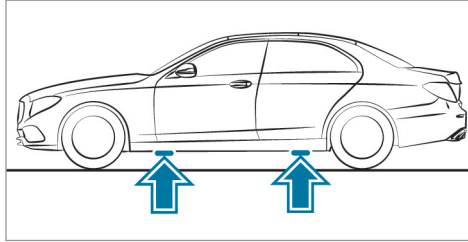

Position of jack support points

- ⚠ **WARNING** Risk of injury from incorrect positioning of the jack

If you do not position the jack correctly at the appropriate jacking point of the vehicle, the jack could tip with the vehicle raised.

- ▶ Only position the jack at the appropriate jacking point of the vehicle. The base of the jack must be positioned vertically under the jacking point of the vehicle.

- ⓘ **NOTE** Vehicle damage from the jack

If you do not position the jack correctly at the appropriate jack support point of the vehicle, the jack could tip over with the vehicle raised.

- ▶ The jack is designed exclusively for jacking up the vehicle at the jack support points.

- ▶ Take the ratchet ring spanner out of the tire-change tool kit and place it on the hexagon nut of the jack so that the lettering "AUF" is visible.

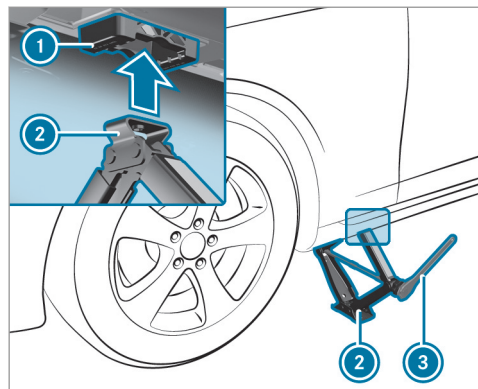

- ▶ Position jack ② at jack support point ①.
- ▶ Turn ratchet ring spanner ③ clockwise until jack ② sits completely on jack support point ① and the base of the jack lies evenly on the ground.
- ▶ Continue to turn ratchet ring spanner ③ until the tire is raised a maximum of 1.2 in (3 cm) off the ground.
- ▶ Loosen and remove the wheel (→ page 380).

### Removing a wheel

#### Requirement:

- The vehicle is raised (→ page 378).

When changing a wheel, avoid applying any force to the brake discs, since this could impair the level of comfort when braking.

**!** **NOTE** Damage to threading from dirt on wheel bolts

▶ Do not place wheel bolts in sand or on a dirty surface.

- ▶ Unscrew the uppermost wheel bolt completely.

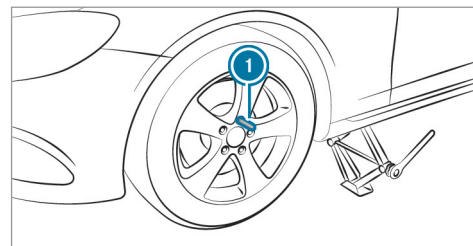

- ▶ Screw centering pin ① instead of the wheel bolt into the threading.
- ▶ Unscrew the remaining wheel bolts fully.
- ▶ Remove the wheel.
- ▶ Install the new wheel (→ page 380).

### Installing a new wheel

#### Requirement:

- The wheel is removed (→ page 380).

**⚠ WARNING** Risk of accident from losing a wheel

Oiled, greased or damaged wheel bolt/wheel nut threads or wheel hub/wheel mounting bolt threads can cause the wheel bolts/wheel nuts to come loose.

As a result, you could lose a wheel while driving.

- ▶ Never oil or grease the threads.
- ▶ In the event of damage to the threads, contact a qualified specialist workshop immediately.
- ▶ Have the damaged wheel bolts or damaged hub threads replaced.
- ▶ Do not continue driving.

- ▶ Observe the information on the choice of tires (→ page 373).

For tires with a specified direction of rotation, an arrow on the side wall of the tire indicates the correct direction of rotation. Observe the direction of rotation when installing.

- ▶ Slide the wheel to be mounted onto the centering pin and push it on.

**⚠ WARNING** Risk of injury from tightening wheel bolts and nuts

If you tighten the wheel bolts or wheel nuts when the vehicle is raised, the jack could tip.

- ▶ Only tighten wheel bolts or wheel nuts when the vehicle is on the ground.

- ▶ For safety reasons, only use wheel bolts which have been approved by Mercedes-Benz and for the wheel in question.

**! NOTE** Damage to paintwork of the wheel rim when screwing on the first wheel bolt

If the wheel has too much play when screwing in the first wheel bolt, the wheel rim paint can be damaged.

- ▶ Press the wheel firmly against the wheel hub when screwing on the first wheel bolt.

- ▶ Tighten the wheel bolts until they are finger-tight.
- ▶ Unscrew the centering pin.
- ▶ Tighten the last wheel bolt until it is finger-tight.
- ▶ Lower the vehicle (→ page 381).

### Lowering the vehicle after a wheel change

**Requirements:**

- The new wheel has been installed (→ page 380).
- ▶ Place the ratchet ring spanner onto the hexagon nut of the jack so that the lettering "AB" is visible.
- ▶ **To lower the vehicle:** turn the ratchet ring spanner of the jack anti-clockwise.

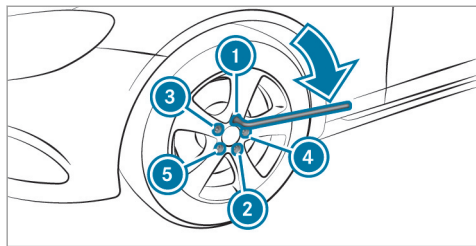

- ▶ Tighten the wheel bolts evenly in a diagonal pattern in the order indicated (1 to 5).  
**Specified tightening torque:** 111 lb-ft (150 Nm).

**⚠ WARNING** Risk of accident due to incorrect tightening torque

The wheels could come loose if the wheel bolts or wheel nuts are not tightened to the prescribed tightening torque.

- ▶ Have the tightening torque checked immediately at a qualified specialist workshop after changing a wheel.

- ▶ Check the tire pressure of the newly mounted wheel and adjust accordingly.
- ▶ **Vehicles with tire pressure loss warning system:** Restart the tire pressure loss warning system (→ page 360).
- ▶ **Vehicles with a tire pressure monitoring system:** Restart the tire pressure monitoring system (→ page 359).

Make sure to observe the following further related subject:

- Notes on tire pressure (→ page 354)



### Notes on technical data

The data stated only applies to vehicles with standard equipment. You can obtain further information from an authorized Mercedes-Benz Center.

### Vehicle electronics

#### Two-way radios

#### Notes on installing two-way radios

**⚠ WARNING** Risk of accident due to improper work on two-way radios

The electromagnetic radiation from two-way radios can interfere with the on-board electronics if RF transmitters are manipulated or retrofitted incorrectly.

This could jeopardize the operating safety of the vehicle.

- ▶ You should have all work on electrical and electronic components carried out at a qualified specialist workshop.

**⚠ WARNING** Risk of accident from incorrect operation of two-way radios

If you operate two-way radios incorrectly in the vehicle, the electromagnetic radiation could interfere with the on-board electronics, e.g.:

- if the two-way radio is not connected to an exterior antenna
- if the exterior antenna is not correctly mounted or is not of low reflection

This could jeopardize the operating safety of the vehicle.

- ▶ Have the low-reflection exterior antenna installed at a qualified specialist workshop.
- ▶ When operating two-way radios in the vehicle, always connect them to the low-reflection exterior antenna.

**! NOTE** Invalidation of the operating permit due to failure to comply with the instructions for installation and use

The operating permit may be invalidated if the instructions for installation and use of two-way radios are not observed.

- ▶ Only use approved frequency bands.
- ▶ Observe the maximum permissible output power in these frequency bands.
- ▶ Only use approved antenna positions.

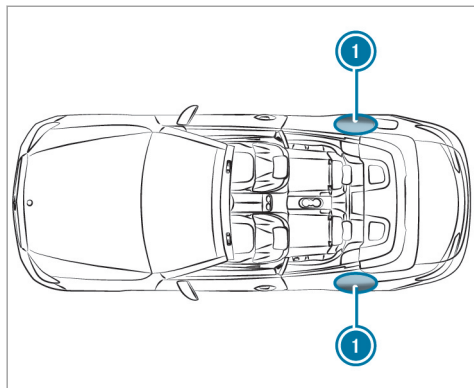

① Rear wing

On the rear wings, it is recommended that you install the antenna on the side of the vehicle closest to the center of the road.

Use Technical Specification ISO/TS 21609 (Road Vehicles - "EMCs for installation of aftermarket radio frequency transmitting equipment") when

installing two-way radios. Comply with the legal requirements for detachable parts.

If your vehicle has installations for two-way radio equipment, use the power supply or antenna connectors intended for use with the basic wiring. Be sure to observe the manufacturer's Supplements when installing.

#### Two-way radio transmission output

The maximum transmission output (PEAK) at the base of the antenna must not exceed the values in the following table:

#### frequency band and maximum transmission output

Frequency band	Maximum transmission output
Short wave 3 - 54 MHz	30 W
4 m frequency band 74 - 88 MHz	15 W

Frequency band	Maximum transmission output
2 m frequency band 144 - 174 MHz	25 W
Trunked radio system/Tetra 380 - 460 MHz	10 W
70 cm frequency band 420 - 450 MHz	15 W
Two-way radio (2G/3G/4G)	10 W

The following can be used in the vehicle without restrictions:

- two-way radios with a maximum transmission output of up to 100 mW
- two-way radios with transmitter frequencies in the 380 - 410 MHz frequency band and a maximum transmission output of up to 2 W (trunked radio system/Tetra)

- mobile phones (2G/3G/4G)

There are no restrictions when positioning the antenna on the outside of the vehicle for the following frequency bands:

- Trunked radio system/Tetra
- 70 cm frequency band
- 2G/3G/4G

### Vehicle identification plate, VIN and engine number

#### Vehicle identification plate

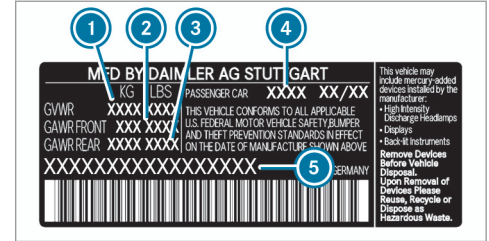
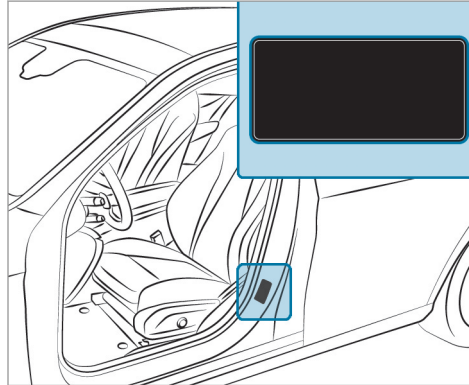

#### Vehicle identification plate (USA only)

- 1 Permissible gross mass
- 2 Permissible front axle load
- 3 Permissible rear axle load
- 4 Paint code
- 5 VIN (vehicle identification number)

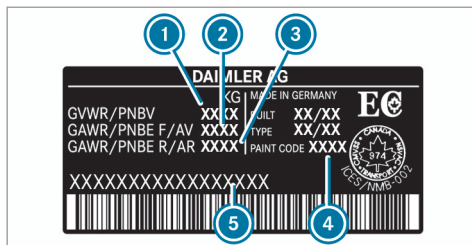

Vehicle identification plate (Canada only)

- ① Permissible gross mass
- ② Permissible front axle load
- ③ Permissible rear axle load
- ④ Paint code
- ⑤ VIN (vehicle identification number)

The maximum permissible gross vehicle weight is made up of the vehicle weight, all vehicle occupants, the fuel and the load. The maximum permissible axle load is the maximum weight that can be carried on one axle (front or rear axle).

Never exceed the maximum gross vehicle weight or the maximum permissible axle load for the front or rear axle.

### VIN in front of the right-hand front seat

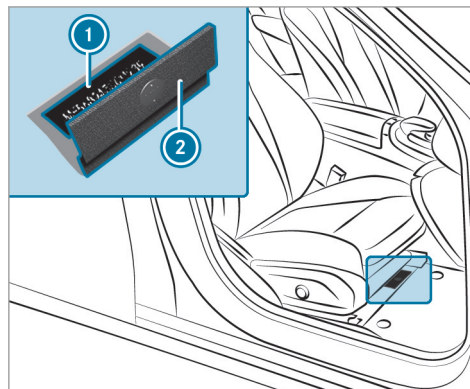

- ① VIN (vehicle identification number)
- ② Floor covering

### Additional plates

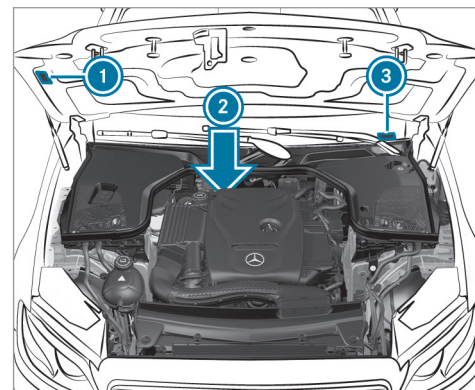

- ① Plate with information about emissions testing, including confirmation of emissions guidelines at the U.S. federal level as well as for California
- ② Engine number (stamped into the crankcase)
- ③ VIN (vehicle identification number)

## Operating fluids

### Notes on operating fluids

**⚠ WARNING** Risk of injury from operating fluids harmful to your health

Operating fluids may be poisonous and harmful to your health.

- ▶ Observe the text on the original containers when using, storing or disposing of operating fluids.
- ▶ Always store operating fluids sealed in their original containers.
- ▶ Always keep children away from operating fluids.

**🔥 ENVIRONMENTAL NOTE** Environmental pollution caused by environmentally irresponsible disposal

- ▶ Dispose of operating fluids in an environmentally responsible manner.

Operating fluids include the following:

- Fuels
- Lubricants
- Coolant
- Brake fluid
- Windshield washer fluid
- Climate control system refrigerant

Only use products approved by Mercedes-Benz. Damage caused by the use of products on the vehicle that have not been approved is not covered by the Mercedes-Benz warranty or goodwill gestures.

You can identify operating fluids approved by Mercedes-Benz by the following inscription on the containers:

- MB-Freigabe (e.g. MB-Freigabe 229.51)
- MB-Approval (e.g. MB-Approval 229.51)

Further information on approved operating fluids:

- in the Mercedes-Benz Specifications for Operating Fluids at <http://bevo.mercedes-benz.com> (by entering the designation)
- in the Mercedes-Benz Specifications for Operating Fluids in the Mercedes-Benz BeVo app (by entering the designation)
- at a qualified specialist workshop

**⚠ WARNING** Risk of fire and explosion caused by fuel

Fuels are highly inflammable.

- ▶ You must avoid fire, open flames, creating sparks and smoking.
- ▶ Before refueling, switch off the engine and, if installed in your vehicle, the stationary heater.

**⚠ WARNING** Risk of injury from fuel

Fuels are poisonous and harmful to your health

- ▶ Do not swallow fuel or let it come into contact with skin, eyes or clothing.
- ▶ Do not inhale fuel vapors.
- ▶ Keep children away from fuel.

If you or other people come into contact with fuel, observe the following:

- ▶ Immediately rinse fuel off your skin with soap and water.
- ▶ If fuel comes into contact with your eyes, immediately rinse them thoroughly with clean water. Seek medical attention immediately.
- ▶ If you swallow fuel, seek medical attention immediately. Do not induce vomiting.
- ▶ Change immediately out of clothing that has come into contact with fuel.

## Fuel

### Information on fuel grades for vehicles with a gasoline engine

Observe the notes on operating fluids (→ page 387).

#### **!** NOTE Damage caused by the wrong fuel

Even small amounts of the wrong fuel could result in damage to the fuel system, the engine and the emission control system.

- ▶ Only refuel with low-sulfur premium grade fuel.

This fuel may contain up to 10 % ethanol. Your vehicle is suitable for use with E10 fuel.

Do not refuel using:

- Diesel
- E15, E85, E100
- Gasoline containing methanol (M15, M30, M85, M100)
- Gasoline with additives containing metal

If you accidentally refuel with the wrong fuel:

- ▶ Do not switch the ignition on.
- ▶ Consult a qualified specialist workshop.

If the available fuel is not sufficiently low in sulfur, this can produce unpleasant odors.

Only refuel with fuel that has at least the octane number specified in the instruction label in the fuel filler flap (→ page 143).

**If you want maximum engine output from the engine:** only refuel using unleaded premium grade gasoline with at least 91 AKI/95 RON.

As a temporary measure, if the recommended fuel is not available, you may also refuel with unleaded regular gasoline with an octane number of at least 87 AKI/91 RON. This may reduce engine output and increase fuel consumption.

Never refuel using gasoline with an even lower RON.

**!** **NOTE** Premature wear caused by unleaded regular gasoline

Unleaded regular gasoline can cause the engine to wear more quickly and impair longevity and performance.

If unleaded premium grade gasoline is unavailable and you have to refuel using unleaded regular gasoline:

- ▶ Only fill the fuel tank to half full with unleaded regular gasoline and refill as soon as possible with unleaded premium grade gasoline.
- ▶ Do not drive at the maximum speed.
- ▶ Avoid sudden acceleration and engine speeds over 3,000 rpm.

Further information on fuel can be found:

- at a gas station
- at a qualified specialist workshop
- **USA only:** at <http://www.mbusa.com>

### Information on additives in gasoline

Observe the notes on operating fluids (→ page 387).

**!** **NOTE** Damage caused by non-approved additives

Even small amounts of the wrong additive may lead to malfunctions occurring.

- ▶ Only add cleaning additives recommended by Mercedes-Benz to the fuel.

Mercedes-Benz recommends that you use brand-name fuels with additives.

The fuel grade available in some countries may not be sufficient. Residue could build up in the fuel injection system as a result. In this case, in consultation with an authorized Mercedes-Benz Center, the fuel may be mixed with the cleaning additive recommended by Mercedes-Benz. Be sure to observe the notes and mixing ratios specified on the container.

### Tank capacity and fuel reserve

#### Capacity

Model	Total capacity
All models	17.4 gal (66.0 l)
Model	Of which reserve
All models	1.8 gal (7.0 l)

#### Engine oil

##### Notes on engine oil

Observe the notes on operating fluids (→ page 387).



**!** **NOTE** Engine damage caused by an incorrect oil filter, incorrect oil or additives

- ▶ Do not use engine oils or oil filters other than those which meet the specifications necessary for the prescribed service intervals.
- ▶ Do not alter the engine oil or oil filter in order to achieve longer change intervals than prescribed.
- ▶ Do not use additives.
- ▶ Have the engine oil changed after the prescribed intervals.

Mercedes-Benz recommends that you have the oil change carried out at a qualified specialist workshop.

Further information on engine oils and oil filters:

- In the Mercedes-Benz Specifications for Operating Fluids at <http://bevo.mercedes-benz.com> (by entering the designation)
- At a qualified specialist workshop

### Quality and filling capacity of engine oil

#### MB-Freigabe or MB-Approval

Gasoline engines	MB-Freigabe or MB-Approval
All models	229.5, 229.6

The following values refer to an oil change, including the oil filter.

#### Replacement amount

Model	Replacement amount
All models	6.9 US qt (6.5 l)

#### Notes on brake fluid

Observe the notes on operating fluids (→ page 387).

**!** **WARNING** Risk of an accident due to vapor pockets forming in the brake system

The brake fluid constantly absorbs moisture from the air. This lowers the boiling point of the brake fluid. If the boiling point is too low, vapor pockets may form in the brake system when the brakes are applied hard.

This causes the braking effect to be impaired.

- ▶ Have the brake fluid renewed at the specified intervals.

Have the brake fluid regularly changed at a qualified specialist workshop.

Only use brake fluid approved by Mercedes-Benz according to MB-Freigabe or MB-Approval 331.0.

Further information on brake fluid:

- in the Mercedes-Benz Specifications for Operating Fluids at <http://bevo.mercedes-benz.com>
- at a qualified specialist workshop



## Coolant

### Notes on coolant

Observe the notes on operating fluids (→ page 387).

**⚠ WARNING** - Risk of fire and injury from antifreeze

If antifreeze comes into contact with hot component parts in the engine compartment, it may ignite.

- ▶ Allow the engine to cool down before adding antifreeze.
- ▶ Make sure that no antifreeze spills out next to the filler opening.
- ▶ Thoroughly clean off any antifreeze from component parts before starting the vehicle.

**! NOTE** Damage caused by incorrect coolant

- ▶ Only add coolant that has been pre-mixed with the required antifreeze protection.

Further information on coolant:

- In the Mercedes-Benz Specifications for Operating Fluids 310.1, e.g. online at <http://bevo.mercedes-benz.com>.
- At a qualified specialist workshop.

**! NOTE** Overheating at high outside temperatures

If an inappropriate coolant is used, the engine cooling system is not sufficiently protected against overheating and corrosion at high outside temperatures.

- ▶ Always use coolant approved by Mercedes-Benz.
- ▶ Observe the instructions in the Mercedes-Benz Specifications for Operating Fluids 310.1.

Have the coolant regularly replaced at a qualified specialist workshop.

The proportion of corrosion inhibitor/antifreeze concentrate in the engine cooling system should be:

- a minimum of 50% (antifreeze protection down to approximately -35 °F (-37 °C)).
- a maximum of 55% (antifreeze protection down to -49 °F (-45 °C)).

### Coolant filling capacity

#### Capacity

Model	Capacity
All models	12.7 US qt (12.0 l)

### Notes on windshield washer fluid

Observe the notes on operating fluids (→ page 387).

**⚠ WARNING** - Risk of fire and injury from windshield washer concentrate

Windshield washer concentrate is highly flammable. It could ignite if it comes into contact with hot engine component parts or the exhaust system.

- ▶ Make sure that no windshield washer concentrate spills out next to the filler opening.

**! NOTE** Damage to the exterior lighting due to unsuitable windshield washer fluid

Unsuitable windshield washer fluid may damage the plastic surface of the exterior lighting.

- ▶ Only use windshield washer fluid which is also suitable for use on plastic surfaces, e.g. MB SummerFit or MB WinterFit.

**! NOTE** Blocked spray nozzles caused by mixing windshield washer fluids

- ▶ Do not mix MB SummerFit and MB WinterFit with other windshield washer fluids.

Do not use distilled or de-ionized water as the fill level sensor may be triggered erroneously.

Recommended windshield washer fluid:

- Above freezing point: e.g. MB SummerFit
- Below freezing point: e.g. MB WinterFit

For the correct mixing ratio refer to the information on the antifreeze container.

Mix the washer fluid with the windshield washer fluid all year round.

### Refrigerant

#### Notes on refrigerants

Observe the notes on operating fluids (→ page 387).

**! NOTE** Damage due to incorrect refrigerant

If a non-approved refrigerant is used, the climate control system may be damaged.

- ▶ Only use the refrigerant R-134a

**! NOTE** Damage to the climate control system due to incorrect refrigerant compressor oil

- ▶ Only use refrigerant compressor oil that has been approved by Mercedes-Benz.
- ▶ Do not mix the approved refrigerant compressor oil with a different refrigerant compressor oil.

Work on the climate control system may only be carried out by a qualified specialist workshop. All applicable regulations, as well as SAE standard J639, must be adhered to.

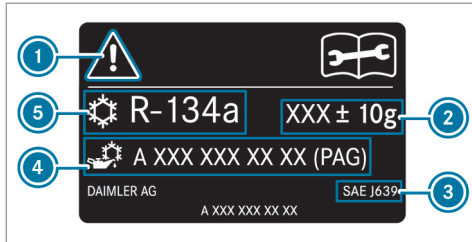

- ① Warning symbols
- ② Refrigerant filling capacity
- ③ Applicable standards
- ④ PAG oil part number
- ⑤ Refrigerant type

Warning symbols ① advise you about:

- possible dangers
- having service work carried out at a qualified specialist workshop

## Refrigerant filling capacity

### Filling capacity for refrigerant and PAG oil

Model	Refrigerant
All models	22.2 ± 0.4 oz (630 ± 10 g)
Model	PAG oil
All models	2.8 ± 0.4 oz (80 ± 10 g)

## Vehicle data

### Vehicle dimensions

The heights specified may vary as a result of the:

- Tires
- Load
- Condition of the suspension
- Optional equipment

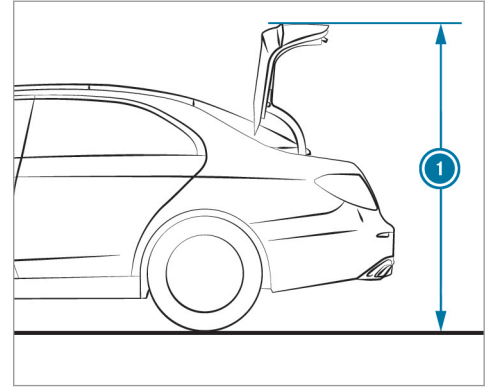

**Height when opened**

Model	 Height when opened
E 400	56.1 in (1424 mm)
E 400 4MATIC	56.4 in (1433 mm)

**Vehicle dimensions**

<b>E 400</b>	
Vehicle length	190 in (4826 mm)
Vehicle width including outside mirrors	80.9 in (2055 mm)
Wheelbase	113.1 in (2873 mm)
Vehicle height	56.3 in (1429 mm)

**E 400**

Vehicle height when opening/closing the roof	78.8 in (2002 mm)
Turning radius	37.3 ft (11.37 m)

**Vehicle dimensions**

<b>E 400 4MATIC</b>	
Vehicle length	190 in (4826 mm)
Vehicle width including outside mirrors	80.9 in (2055 mm)
Wheelbase	113.1 in (2873 mm)
Vehicle height	56.5 in (1436 mm)

**E 400 4MATIC**

Vehicle height when opening/closing the roof	79.1 in (2010 mm)
Turning radius	38.1 ft (11.61 m)

**Weights and loads**

Please note that for the specified vehicle data:

- items of optional equipment increase the unladen weight and reduce the payload.

## Display messages

### Introduction

#### Notes on display messages

Display messages appear on the multifunction display.

Display messages with graphic symbols are simplified in the Operator's Manual and may differ from the symbols on the multifunction display. The multifunction display shows high-priority display messages in red. Certain display messages are accompanied by a warning tone.



Please respond in accordance with the display messages and follow the additional notes in this Operator's Manual.

For some display messages, a symbol is also shown:

-  Further information

-  Hide display message

You can select the desired symbol by swiping left or right on the left-hand Touch Control.

Press the  symbol to show further information on the multifunction display. Press the  symbol to hide the display message.

You can hide low-priority display messages by pressing the  button or the left-hand Touch Control. The display messages are then stored in the message memory.

Rectify the cause of a display message as quickly as possible.

High-priority display messages cannot be hidden. The multifunction display shows these display messages continuously until the cause of the display message has been rectified.

#### Calling up stored display messages

On-board computer:

 Service  1 Message

If there are no display messages, **No Messages** appears on the multifunction display.

▶ Scroll through the display messages by swiping upwards or downwards on the left-hand Touch Control.

▶ **To exit the message memory:** press the  button.

## Safety systems

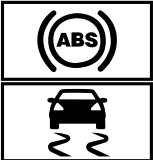
Display messages	Possible causes/consequences and ► Solutions
 <p data-bbox="144 467 417 515">Inoperative See Operator's Manual</p>	<p data-bbox="476 291 1585 410">* ABS and ESP® are malfunctioning. Other driving and driving safety systems may also be malfunctioning. The brake system continues to operate normally. The braking distance in an emergency braking situation can increase.</p> <div data-bbox="495 430 1646 679" style="border: 1px solid gray; padding: 5px;"> <p data-bbox="513 441 1190 467"><b>▲ WARNING</b> Risk of skidding if ABS and ESP® are malfunctioning</p> <p data-bbox="513 482 1585 534">If ABS and ESP® are malfunctioning, the wheels could lock when braking and ESP® cannot carry out vehicle stabilization.</p> <p data-bbox="513 544 1622 596">The steering capability and braking characteristics are thus severely impaired. The braking distance in an emergency braking situation can increase. In addition, other driving safety systems are switched off.</p> <ul style="list-style-type: none"> <li data-bbox="513 607 728 627">► Drive on carefully.</li> <li data-bbox="513 638 1308 669">► Have ABS and ESP® checked immediately at a qualified specialist workshop.</li> </ul> </div> <ul style="list-style-type: none"> <li data-bbox="495 695 709 721">► Drive on carefully.</li> <li data-bbox="495 731 1049 757">► Consult a qualified specialist workshop immediately.</li> </ul>

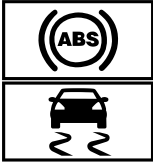





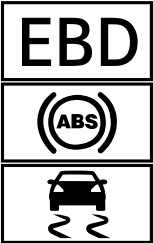

Display messages	Possible causes/consequences and ► Solutions
<div data-bbox="205 253 362 422">  </div> <p data-bbox="195 427 458 477">Currently Unavailable See Operator's Manual</p>	<p data-bbox="526 251 972 277">* ABS and ESP® are temporarily unavailable.</p> <p data-bbox="543 286 1404 312">Other driving systems and driving safety systems may also be temporarily unavailable.</p> <p data-bbox="543 322 1637 370">The brake system continues to operate normally. The braking distance in an emergency braking situation can increase.</p> <div data-bbox="565 399 1241 427" style="background-color: #f0f0f0; padding: 5px;"> <p data-bbox="565 399 1241 427"><b>▲ WARNING</b> Risk of skidding if ABS and ESP® are malfunctioning</p> </div> <p data-bbox="559 443 1642 492">If ABS and ESP® are malfunctioning, the wheels could lock when braking and ESP® cannot carry out vehicle stabilization.</p> <p data-bbox="559 504 1677 553">The steering capability and braking characteristics are thus severely impaired. The braking distance in an emergency braking situation can increase. In addition, other driving safety systems are switched off.</p> <ul data-bbox="559 565 1360 627" style="list-style-type: none"> <li data-bbox="559 565 778 591">► Drive on carefully.</li> <li data-bbox="559 601 1360 627">► Have ABS and ESP® checked immediately at a qualified specialist workshop.</li> </ul> <ul data-bbox="543 655 1687 737" style="list-style-type: none"> <li data-bbox="543 655 1626 704">► Drive carefully on a suitable stretch of road, making slight steering movements at a speed above 19 mph (30 km/h).</li> <li data-bbox="543 714 1687 737">► If the display message does not disappear, consult a qualified specialist workshop immediately. Drive carefully.</li> </ul>

Display messages	Possible causes/consequences and ► Solutions
 <p data-bbox="144 342 408 391">Currently Unavailable See Operator's Manual</p>	<p data-bbox="476 249 1184 311">* ESP® is temporarily unavailable. Other driving and driving safety systems may also be malfunctioning.</p> <div data-bbox="495 329 1646 515" style="border: 1px solid gray; padding: 5px;"><p data-bbox="513 339 1086 365"><b>▲ WARNING</b> Risk of skidding if ESP® is malfunctioning</p><p data-bbox="513 381 1615 433">If ESP® is malfunctioning, ESP® cannot carry out vehicle stabilization. In addition, other driving safety systems are switched off.</p><ul data-bbox="513 443 1092 505" style="list-style-type: none"><li data-bbox="513 443 728 469">▶ Drive on carefully.</li><li data-bbox="513 479 1092 505">▶ Have ESP® checked at a qualified specialist workshop.</li></ul></div> <ul data-bbox="495 531 1637 619" style="list-style-type: none"><li data-bbox="495 531 1578 583">▶ Carefully drive on a suitable stretch of road, making slight steering movements at a speed above 19 mph (30 km/h).</li><li data-bbox="495 593 1637 619">▶ If the display message does not disappear, consult a qualified specialist workshop immediately. Drive carefully.</li></ul>



Display messages	Possible causes/consequences and ► Solutions
 <p data-bbox="199 343 469 391">Inoperative See Operator's Manual</p>	<p data-bbox="528 250 783 277">* ESP® is malfunctioning.</p> <p data-bbox="547 288 1234 314">Other driving and driving safety systems may also be malfunctioning.</p> <p data-bbox="547 325 1633 372">The brake system continues to operate normally. The braking distance in an emergency braking situation can increase.</p> <div data-bbox="554 391 1696 433"><p data-bbox="569 401 1134 428"><b>▲ WARNING</b> Risk of skidding if ESP® is malfunctioning</p></div> <p data-bbox="565 443 1663 491">If ESP® is malfunctioning, ESP® cannot carry out vehicle stabilization. In addition, other driving safety systems are switched off.</p> <ul data-bbox="565 505 1142 567" style="list-style-type: none"><li data-bbox="565 505 779 532">► Drive on carefully.</li><li data-bbox="565 542 1142 567">► Have ESP® checked at a qualified specialist workshop.</li></ul> <ul data-bbox="547 594 1105 656" style="list-style-type: none"><li data-bbox="547 594 761 621">► Drive on carefully.</li><li data-bbox="547 629 1105 656">► Consult a qualified specialist workshop immediately.</li></ul>

Display messages	Possible causes/consequences and ► Solutions
 <p>Inoperative See Operator's Manual</p>	<p>* EBD, ABS and ESP® are malfunctioning. Other driving and driving safety systems may also be malfunctioning.</p> <p><b>▲ WARNING</b> Risk of skidding if EBD, ABS and ESP® are malfunctioning</p> <p>If EBD, ABS and ESP® are malfunctioning, the wheels can lock when braking and ESP® cannot carry out vehicle stabilization.</p> <p>The steering capability and braking characteristics are thus severely impaired. The braking distance in an emergency braking situation can increase. In addition, other driving safety systems are switched off.</p> <ul style="list-style-type: none"><li>▶ Drive on carefully.</li><li>▶ Have the brake system checked immediately at a qualified specialist workshop.</li></ul> <p>► Drive on carefully. ► Consult a qualified specialist workshop immediately.</p>

Display messages	Possible causes/consequences and ► Solutions
<div data-bbox="205 252 362 335"></div> <div data-bbox="205 342 306 366">(USA only)</div> <div data-bbox="205 381 362 464"></div> <div data-bbox="205 471 340 495">(Canada only)</div> <div data-bbox="195 505 463 557">Turn On the Ignition to Release the Parking Brake</div>	<p>* The red  (USA only) or  (Canada only) indicator lamp is lit. You have attempted to release the electric parking brake with the ignition switched off.</p> <ul style="list-style-type: none"> <li>► Switch on the ignition.</li> </ul>
<div data-bbox="205 573 362 656"></div> <div data-bbox="205 664 306 687">(USA only)</div> <div data-bbox="205 702 362 785"></div> <div data-bbox="205 792 340 816">(Canada only)</div> <div data-bbox="195 826 426 873">Please Release Parking Brake</div>	<p>* The red  (USA only) or  (Canada only) indicator lamp flashes. The electric parking brake is applied while you are driving:</p> <ul style="list-style-type: none"> <li>• A condition for automatic release of the electric parking brake is not fulfilled.</li> <li>• You are performing emergency braking using the electric parking brake.</li> </ul> <ul style="list-style-type: none"> <li>► Check that the conditions for automatic release of the electric parking brake are fulfilled.</li> <li>► Release the electric parking brake manually.</li> </ul>

Display messages



(USA only)



(Canada only)

[Parking Brake See Operator's Manual](#)

Possible causes/consequences and ► Solutions



\* The yellow  indicator lamp is lit. The electric parking brake is malfunctioning.

**To apply:**

- Switch off the ignition and turn it back on.
- Apply the electric parking brake manually.

If it is not possible to apply the electric parking brake:

- Visit a qualified specialist workshop.
- Where necessary, also safeguard the parked vehicle against rolling away.

The yellow  and the red  (USA only) or  (Canada only) indicator lamps are lit. The electric parking brake is malfunctioning.

**To release:**



- Switch off the ignition and turn it back on.
- Release the electric parking brake manually.

or





- Release the electric parking brake automatically.

If it is still not possible to release the electric parking brake:

- Do not continue driving under any circumstances. Consult a qualified specialist workshop.





The yellow  indicator lamp is lit and the red  (USA only) or  (Canada only) indicator lamp is flashing. The electric parking brake is malfunctioning.

The electric parking brake could not be applied or released.

Display messages	Possible causes/consequences and ► Solutions
	<ul style="list-style-type: none"><li>► Switch off the ignition and turn it back on.</li></ul> <p><b>To apply:</b></p> <ul style="list-style-type: none"><li>► Release and then apply the electric parking brake manually.</li></ul> <p><b>To release:</b></p> <ul style="list-style-type: none"><li>► Apply and then release the electric parking brake manually.</li></ul> <p>If the electric parking brake cannot be applied or the red  (USA only) or  (Canada only) indicator lamp continues to flash:</p> <ul style="list-style-type: none"><li>► Do not continue driving under any circumstances. Consult a qualified specialist workshop.</li><li>► Where necessary, also safeguard the parked vehicle against rolling away.</li></ul> <p>The yellow  indicator lamp is on and the red  indicator lamp (USA only) or  (Canada only) indicator lamp flashes for approximately ten seconds after the electric parking brake has been applied or released. It then remains lit or goes out. The electric parking brake is malfunctioning.</p> <p><b>If the battery charge level is too low:</b></p> <ul style="list-style-type: none"><li>► Charge the battery.</li></ul> <p><b>To apply:</b></p> <ul style="list-style-type: none"><li>► Switch the ignition off. The electric parking brake is applied automatically.</li></ul>

#### 404 Display messages and warning/indicator lamps

Display messages	Possible causes/consequences and ► Solutions
	<p>If the electric parking brake should not be applied, e.g. when washing the vehicle in an automatic car wash or when having the vehicle towed, leave the ignition switched on. Do not do this when having the vehicle towed with the rear axle raised.</p> <p>If the electric parking brake is not applied automatically:</p> <ul style="list-style-type: none"><li>► Switch off the ignition and turn it back on.</li><li>► Release and then apply the electric parking brake manually.</li></ul> <p>If it is still not possible to apply the electric parking brake:</p> <ul style="list-style-type: none"><li>► Visit a qualified specialist workshop.</li><li>► Where necessary, also safeguard the parked vehicle against rolling away.</li></ul> <p><b>To release:</b></p> <ul style="list-style-type: none"><li>► If the conditions for automatic release are fulfilled and the electric parking brake is not released automatically, release the electric parking brake manually.</li></ul> <p>If it is still not possible to release the electric parking brake:</p> <ul style="list-style-type: none"><li>► Do not continue driving under any circumstances. Consult a qualified specialist workshop.</li></ul>

Display messages	Possible causes/consequences and ► Solutions
 <p>(USA only)</p>  <p>(Canada only)</p> <p>Check Brake Fluid Level</p>	<p>* There is insufficient brake fluid in the brake fluid reservoir.</p> <div style="border: 1px solid gray; padding: 5px; margin: 10px 0;"> <p><b>▲ WARNING</b> Risk of an accident due to low brake fluid level</p> <p>If the brake fluid level is too low, the braking effect and the braking characteristics may be impaired.</p> <ul style="list-style-type: none"> <li>▶ Pull over and stop the vehicle safely as soon as possible, paying attention to road and traffic conditions. Do not continue driving under any circumstances.</li> <li>▶ Consult a qualified specialist workshop. Do not add brake fluid.</li> </ul> </div> <ul style="list-style-type: none"> <li>▶ Pull over and stop the vehicle safely as soon as possible, paying attention to road and traffic conditions. Do not continue driving under any circumstances.</li> <li>▶ Consult a qualified specialist workshop. Do not top up the brake fluid.</li> </ul>
 <p>Check Brake Pad Wear</p>	<p>* The brake pads have reached the wear limit.</p> <ul style="list-style-type: none"> <li>▶ Visit a qualified specialist workshop.</li> </ul>
 <p>Inoperative</p>	<p>* USA only: at least one of the mbrace system's main features is malfunctioning.</p> <ul style="list-style-type: none"> <li>▶ Visit a qualified specialist workshop.</li> </ul>

## 406 Display messages and warning/indicator lamps

---



Display messages	Possible causes/consequences and ► Solutions
<a href="#">Radar Sensors Dirty See Operator's Manual</a>	<p>* The radar sensor system is malfunctioning. Possible causes are:</p> <ul style="list-style-type: none"><li>• soiling of the sensors</li><li>• heavy rain</li><li>• extended country driving without other traffic, e.g. in the desert</li></ul> <p>Driving systems and driving safety systems may be malfunctioning or temporarily unavailable. Once the cause of the problem is no longer present, driving systems and driving safety systems are available again.</p> <p>If the display message does not disappear:</p> <ul style="list-style-type: none"><li>► Pull over and stop the vehicle safely as soon as possible, paying attention to road and traffic conditions.</li><li>► Clean all sensors.</li><li>► Restart the engine.</li></ul>





Display messages	Possible causes/consequences and ► Solutions
<p>Radar Sensors Dirty See Operator's Manual</p>	<p>* The radar sensor system is malfunctioning. Possible causes are:</p> <ul style="list-style-type: none"> <li>• Soiling of the sensors</li> <li>• Heavy rain</li> <li>• Extended country driving without moving traffic, e.g. in the desert</li> </ul> <p>Driving systems and driving safety systems may be malfunctioning or temporarily unavailable. Once the cause of the problem is no longer present, driving systems and driving safety systems are available again. If the display message does not disappear:</p> <ul style="list-style-type: none"> <li>► Pull over and stop the vehicle safely as soon as possible, paying attention to road and traffic conditions.</li> <li>► Clean all sensors.</li> <li>► Restart the engine.</li> </ul>
<p> Example: Left Side Curtain Airbag Malfunction Service Required</p>	<p>* The corresponding head air bag is malfunctioning.</p> <p><b>⚠ WARNING</b> Risk of injury or death due to malfunctions in the head air bag</p> <p>If the head air bag is malfunctioning, it might be triggered unintentionally or might not be triggered at all in the event of an accident with a high rate of vehicle deceleration.</p> <ul style="list-style-type: none"> <li>► Have the head air bag checked and repaired immediately at a qualified specialist workshop.</li> <li>► Consult a qualified specialist workshop immediately.</li> </ul>

## 408 Display messages and warning/indicator lamps

Display messages	Possible causes/consequences and ► Solutions
<a href="#">Active Brake Assist Functions Currently Limited See Operator's Manual</a>	<p>* <b>Vehicles with the Driving Assistance Package:</b> Active Brake Assist with cross-traffic function, Evasive Steering Assist or PRE-SAFE® PLUS are temporarily unavailable or only partially available.</p> <p><b>Vehicles without the Driving Assistance package:</b> Active Brake Assist is temporarily unavailable.</p> <p>The ambient conditions are outside the system limitations.</p> <ul style="list-style-type: none"><li>► Drive on. As soon as the ambient conditions are within the system limitations, the system will become available again.</li><li>► If the display message does not disappear, stop the vehicle while paying attention to road and traffic conditions and restart the engine.</li></ul>
<a href="#">Active Brake Assist Functions Limited See Operator's Manual</a>	<p>* <b>Vehicles with Driving Assistance Package:</b> Active Brake Assist with cross-traffic function, Evasive Steering Assist or PRE-SAFE® PLUS is malfunctioning.</p> <p><b>Vehicles without Driving Assistance Package:</b> Active Brake Assist is malfunctioning.</p> <ul style="list-style-type: none"><li>► Visit a qualified specialist workshop.</li></ul>
<a href="#">PRE-SAFE Inoperative See Operator's Manual</a>	<p>* PRE-SAFE® functions are malfunctioning.</p> <ul style="list-style-type: none"><li>► Visit a qualified specialist workshop.</li></ul>



Display messages	Possible causes/consequences and ► Solutions
 <p data-bbox="195 344 445 394">SRS Malfunction Service Required</p>	<p data-bbox="524 249 883 273">* The restraint system is defective .</p> <div data-bbox="547 293 1702 464" style="border: 1px solid gray; padding: 5px;"> <p data-bbox="565 301 1434 327">▲ <b>WARNING</b> Risk of injury or fatal injury due to a malfunction in the restraint system</p> <p data-bbox="565 342 1646 418">If the restraint system is malfunctioning, restraint system components may be triggered unintentionally or might not be triggered at all in the event of an accident. This may affect the Emergency Tensioning Device or airbag, for example.</p> <p data-bbox="565 428 1548 454">► Have the restraint system checked and repaired immediately at a qualified specialist workshop.</p> </div> <p data-bbox="547 480 986 506">Detection of a restraint system malfunction:</p> <ul data-bbox="547 516 1517 576" style="list-style-type: none"> <li>• the  restraint system warning lamp does not light up when the ignition is switched on.</li> <li>• the  restraint system warning lamp lights up continuously or repeatedly during a journey.</li> </ul> <p data-bbox="547 591 1105 617">► Consult a qualified specialist workshop immediately.</p>



Display messages	Possible causes/consequences and ► Solutions
<div data-bbox="155 251 312 334" data-label="Image"> </div> <p data-bbox="144 342 421 391">Front Left Malfunction Service Required (Example)</p>	<p data-bbox="476 249 1031 272">* The corresponding restraint system is malfunctioning.</p> <div data-bbox="513 291 1648 464" data-label="Complex-Block"> <p data-bbox="513 298 1382 324">▲ <b>WARNING</b> Risk of injury or fatal injury due to a malfunction in the restraint system</p> <p data-bbox="513 339 1594 417">If the restraint system is malfunctioning, restraint system components may be triggered unintentionally or might not be triggered at all in the event of an accident. This may affect the Emergency Tensioning Device or airbag, for example.</p> <p data-bbox="513 427 1498 453">► Have the restraint system checked and repaired immediately at a qualified specialist workshop.</p> </div> <p data-bbox="495 479 935 505">Detection of a restraint system malfunction:</p> <ul data-bbox="500 515 1465 572" style="list-style-type: none"> <li>• the  restraint system warning lamp does not light up when the ignition is switched on.</li> <li>• the  restraint system warning lamp lights up continuously or repeatedly during a journey.</li> </ul> <p data-bbox="495 593 1049 619">► Consult a qualified specialist workshop immediately.</p>
<div data-bbox="155 631 312 714" data-label="Image"> </div> <p data-bbox="144 723 389 800">Left Side Curtain Airbag Malfunction Service Required (example)</p>	<p data-bbox="476 629 1031 655">* The corresponding window air bag is malfunctioning .</p> <div data-bbox="513 674 1648 816" data-label="Complex-Block"> <p data-bbox="513 681 1360 707">▲ <b>WARNING</b> Risk of injury or fatal injury due to malfunctions in the window airbag</p> <p data-bbox="513 723 1594 769">If the window airbag is malfunctioning, it might be triggered unintentionally or might not be triggered at all in the event of an accident with high deceleration.</p> <p data-bbox="513 780 1480 806">► Have the window airbag checked and repaired immediately at a qualified specialist workshop.</p> </div> <p data-bbox="495 831 1018 857">► Visit a qualified specialist workshop immediately.</p>

Display messages	Possible causes/consequences and ► Solutions
Front Passenger Airbag Disabled See Operator's Manual	<p>* The front passenger air bag and the knee air bag are deactivated, even though an adult or a person with a build corresponding to that of an adult is seated on the front passenger seat. If additional forces are applied to the seat, the weight the system detects may be too low.</p> <p><b>▲ WARNING</b> Risk of injury or fatal injury due to a disabled front passenger airbag</p> <p>If the front passenger airbag is disabled, the front passenger airbag will not be deployed in the event of an accident and cannot perform its intended protective function.</p> <p>A person in the front passenger seat could then, for example, come into contact with the vehicle's interior, especially if the person is sitting too close to the cockpit.</p> <p>► Make sure, both before and during the journey, that the status of the front passenger airbag is correct.</p> <ul style="list-style-type: none"><li>► Pull over and stop the vehicle safely as soon as possible, paying attention to road and traffic conditions.</li><li>► Check the status of the automatic front passenger air bag shutoff .</li><li>► If necessary, consult a qualified specialist workshop immediately.</li></ul>

Display messages	Possible causes/consequences and ► Solutions
<p>Front Passenger Airbag Enabled See Operator's Manual</p>	<p>* The front passenger air bag and knee air bags are enabled during the journey:</p> <ul style="list-style-type: none"><li>• even when a child, a small adult or an object weighing less than the system weight threshold is located on the front passenger seat</li><li>• even when the front passenger seat is not occupied</li></ul> <p>The system may detect objects or forces that are adding to the weight applied to the seat.</p> <p><b>▲ WARNING</b> Risk of injury or fatal injury when using a child restraint system while the front passenger air bag is enabled</p> <p>If you secure a child in a child restraint system on the front passenger seat and the front passenger air bag is enabled, the front passenger air bag can deploy in the event of an accident.</p> <p>The child could be struck by the air bag.</p> <p>► Ensure, both before and during the journey, that the status of the front passenger air bag is correct.</p> <p>NEVER use a rearward facing child restraint on a seat protected by an ACTIVE FRONT AIR BAG; DEATH or SERIOUS INJURY to the CHILD can occur.</p> <ul style="list-style-type: none"><li>► Pull over and stop the vehicle safely as soon as possible, paying attention to road and traffic conditions.</li><li>► Check the status of the automatic front passenger air bag shutoff.</li><li>► If necessary, consult a qualified specialist workshop immediately.</li></ul>

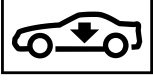
## Driving systems

Display messages	Possible causes/consequences and ► Solutions
 <p data-bbox="195 384 473 430">ATTENTION ASSIST: Take a Break!</p>	<ul style="list-style-type: none"> <li data-bbox="519 291 1578 342">* ATTENTION ASSIST has detected fatigue or an increasing lack of concentration on the part of the driver (→ page 189).</li> <li data-bbox="543 350 842 377">► If necessary, take a break.</li> </ul>
 <p data-bbox="195 542 473 589">ATTENTION ASSIST Inoperative</p>	<ul style="list-style-type: none"> <li data-bbox="519 449 924 470">* ATTENTION ASSIST is malfunctioning.</li> <li data-bbox="543 477 944 504">► Visit a qualified specialist workshop.</li> </ul>
 <p data-bbox="195 700 340 721">Vehicle Rising</p>	<ul style="list-style-type: none"> <li data-bbox="519 608 1092 628">* Your vehicle is adjusting to the level you have selected.</li> </ul>
 <p data-bbox="195 828 288 849">Lowering</p>	<ul style="list-style-type: none"> <li data-bbox="519 736 1092 757">* Your vehicle is adjusting to the level you have selected.</li> </ul>

Display messages	Possible causes/consequences and ► Solutions
 <p>Vehicle Rising Please Wait</p>	<p>* The vehicle level is too low. The vehicle will be raised to the selected vehicle level.</p> <ul style="list-style-type: none"> <li>► Wait until the display message disappears before pulling away.</li> </ul>
 <p>Stop Vehicle Vehicle Too Low</p>	<p>* You have pulled away despite the vehicle level being too low.</p> <ul style="list-style-type: none"> <li>► Pull over and stop the vehicle safely as soon as possible, paying attention to road and traffic conditions. The vehicle will be raised to the selected vehicle level.</li> <li>► Wait until the display message disappears before pulling away.</li> </ul> <p>If the display message does not disappear and a warning tone also sounds, AIR BODY CONTROL/DYNAMIC BODY CONTROL is malfunctioning:</p> <ul style="list-style-type: none"> <li>► Do not drive faster than 50 mph (80 km/h) and consult a qualified specialist workshop immediately.</li> </ul> <div style="border: 1px solid black; padding: 5px; margin-top: 10px;"> <p><b>!</b> <b>NOTE</b> The tires of the front axle or the front fenders could be damaged by large steering movements</p> <ul style="list-style-type: none"> <li>► Avoid large steering movements while driving and listen for scraping sounds.</li> <li>► If you hear scraping sounds, pull over and stop the vehicle safely, paying attention to road and traffic conditions, and set a higher vehicle level if possible.</li> </ul> </div> <ul style="list-style-type: none"> <li>► Set a higher vehicle level.</li> <li>► Depending on the malfunction, the vehicle is raised.</li> </ul>





Display messages	Possible causes/consequences and ► Solutions
 Malfunction Drive at Max. 50 mph	<ul style="list-style-type: none"> <li>* The AIR BODY CONTROL function is restricted. The vehicle's handling characteristics may be affected.               <ul style="list-style-type: none"> <li>► Drive in a manner appropriate for the current level, but do not exceed 50 mph (80 km/h).</li> <li>► Visit a qualified specialist workshop.</li> </ul> </li> </ul>
Active Lane Keeping Assist Currently Unavailable See Operator's Manual	<ul style="list-style-type: none"> <li>* Active Lane Keeping Assist is temporarily unavailable.              The ambient conditions are outside the system limitations (→ page 195).  <b>Vehicles with Active Steering Assist:</b> The camera view may be limited by the windshield.               <ul style="list-style-type: none"> <li>► Drive on.                    As soon as the ambient conditions are within the system limitations, the system will become available again.</li> </ul> <p>If the display message does not disappear on vehicles with Active Steering Assist:</p> <ul style="list-style-type: none"> <li>► Pull over and stop the vehicle safely as soon as possible, paying attention to road and traffic conditions.</li> <li>► Clean the windshield.</li> </ul> </li> </ul>
Active Lane Keeping Assist Inoperative	<ul style="list-style-type: none"> <li>* Active Lane Keeping Assist is malfunctioning.               <ul style="list-style-type: none"> <li>► Visit a qualified specialist workshop.</li> </ul> </li> </ul>

Display messages	Possible causes/consequences and ► Solutions
<p>Active Lane Keeping Assist Camera View Restricted See Operator's Manual</p>	<p>* <b>Vehicles without Active Steering Assist:</b> the camera view is restricted.</p> <p>Possible causes are:</p> <ul style="list-style-type: none"> <li>• dirt on the windshield in the camera's field of vision</li> <li>• heavy rain, snow or fog</li> </ul> <p>Driving systems and driving safety systems may be malfunctioning or temporarily unavailable.</p> <p>Once the cause of the problem is no longer present, driving systems and driving safety systems are available again.</p> <p>If the display message does not disappear:</p> <ul style="list-style-type: none"> <li>► Pull over and stop the vehicle safely as soon as possible, paying attention to road and traffic conditions.</li> <li>► Clean the windshield.</li> </ul>
<p>Blind Spot Assist Currently Unavailable See Operator's Manual</p>	<p>* Blind Spot Assist is temporarily unavailable.</p> <p>The system limitations have been reached (→ page 193).</p> <ul style="list-style-type: none"> <li>► Drive on.</li> </ul> <p>Once the cause of the problem is no longer present, the system will be available again.</p> <p>or</p> <ul style="list-style-type: none"> <li>► If the display message does not disappear, stop the vehicle while paying attention to road and traffic conditions and restart the engine.</li> <li>► If necessary, clean the rear bumper. If the bumper is extremely dirty, the sensors in the bumper may be malfunctioning.</li> </ul>



Display messages	Possible causes/consequences and ► Solutions
Active Blind Spot Assist Currently Unavailable See Operator's Manual	<ul style="list-style-type: none"> <li>* Active Blind Spot Assist is temporarily unavailable. The system limitations have been reached (→ page 193).               <ul style="list-style-type: none"> <li>► Drive on. Once the cause of the problem is no longer present, the system will be available again.</li> <li>► If the display message does not disappear, stop the vehicle while paying attention to road and traffic conditions and restart the engine.</li> </ul> </li> </ul>
Blind Spot Assist Not Available When Towing a Trailer See Operator's Manual	<ul style="list-style-type: none"> <li>* When you establish the electrical connection to the trailer, Blind Spot Assist is unavailable.               <ul style="list-style-type: none"> <li>► Press the left-hand side Touch Control and acknowledge the display message.</li> </ul> </li> </ul>
Active Blind Spot Asst. Not Available When Towing a Trailer See Operator's Manual	<ul style="list-style-type: none"> <li>* When you establish the electrical connection to the trailer, Active Blind Spot Assist is unavailable.               <ul style="list-style-type: none"> <li>► Press the left-hand Touch Control and acknowledge the display message.</li> </ul> </li> </ul>
Blind Spot Assist Inoperative	<ul style="list-style-type: none"> <li>* Blind Spot Assist is malfunctioning.               <ul style="list-style-type: none"> <li>► Visit a qualified specialist workshop.</li> </ul> </li> </ul>
Active Blind Spot Assist Inoperative	<ul style="list-style-type: none"> <li>* Active Blind Spot Assist is malfunctioning.               <ul style="list-style-type: none"> <li>► Visit a qualified specialist workshop.</li> </ul> </li> </ul>

## 418 Display messages and warning/indicator lamps

Display messages	Possible causes/consequences and ► Solutions
<p>Active Parking Assist and PARKTRONIC Inoperative See Operator's Manual</p>	<p>* Active Parking Assist and Parking Assist PARKTRONIC are malfunctioning.</p> <ul style="list-style-type: none"> <li>► Stop the vehicle, paying attention to road and traffic conditions, and restart the engine.</li> <li>► If the display message continues to be displayed, consult a qualified specialist workshop.</li> </ul>
<p>Traffic Sign Assist Currently Unavailable See Operator's Manual</p>	<p>* Traffic Sign Assist is temporarily unavailable.</p> <ul style="list-style-type: none"> <li>► Drive on.</li> </ul> <p>Once the cause of the problem is no longer present, the system will be available again.</p>
<p>Traffic Sign Assist Camera View Restricted See Operator's Manual</p>	<p>* The camera view is restricted. Possible causes are:</p> <ul style="list-style-type: none"> <li>• dirt on the windshield in the camera's field of vision</li> <li>• heavy rain, snow or fog</li> </ul> <p>Driving systems and driving safety systems may be malfunctioning or temporarily unavailable.</p> <p>Once the cause of the problem is no longer present, driving systems and driving safety systems will become available again.</p> <p>If the display message does not disappear:</p> <ul style="list-style-type: none"> <li>► Pull over and stop the vehicle safely as soon as possible, paying attention to road and traffic conditions.</li> <li>► Clean the windshield.</li> </ul>
<p>Traffic Sign Assist Inoperative</p>	<p>* Traffic Sign Assist is malfunctioning.</p> <ul style="list-style-type: none"> <li>► Visit a qualified specialist workshop.</li> </ul>

Display messages	Possible causes/consequences and ► Solutions
 <p>Off</p>	<ul style="list-style-type: none"> <li>* The HOLD function is deactivated because the vehicle is skidding or a condition for activation is not met.               <ul style="list-style-type: none"> <li>► Reactivate the HOLD function later or check the activation conditions for the HOLD function.</li> </ul> </li> </ul>
<p>Active Distance Assist Now Available</p>	<ul style="list-style-type: none"> <li>* Active Distance Assist DISTRONIC is operational again and can be activated (→ page 164).</li> </ul>
<p>Active Distance Assist Currently Unavailable See Operator's Manual</p>	<ul style="list-style-type: none"> <li>* Active Distance Assist DISTRONIC is temporarily unavailable. The ambient conditions are outside the system limitations (→ page 162).               <ul style="list-style-type: none"> <li>► Drive on. As soon as the ambient conditions are within the system limitations, the system will become available again.</li> </ul> </li> </ul>
<p>Active Distance Assist Inoperative</p>	<ul style="list-style-type: none"> <li>* Active Distance Assist DISTRONIC is malfunctioning. Other driving and driving safety systems may also be malfunctioning.               <ul style="list-style-type: none"> <li>► Visit a qualified specialist workshop.</li> </ul> </li> </ul>
 <p>Active Steering Assist Currently Unavailable See Operator's Manual</p>	<ul style="list-style-type: none"> <li>* Active Steering Assist is temporarily unavailable. The ambient conditions are outside the system limitations (→ page 167).               <ul style="list-style-type: none"> <li>► Drive on. As soon as the ambient conditions are within the system limitations, the system will become available again.</li> <li>► If necessary, clean the windshield in the camera's field of vision.</li> </ul> </li> </ul>



## 420 Display messages and warning/indicator lamps

Display messages	Possible causes/consequences and ► Solutions
 <p data-bbox="144 342 421 389">Active Steering Assist Inoperative</p>	<ul style="list-style-type: none"><li>* Active Steering Assist is malfunctioning. Active Distance Assist DISTRONIC remains available.<ul style="list-style-type: none"><li>► Visit a qualified specialist workshop.</li></ul></li></ul>
 <p data-bbox="144 513 389 539">Cruise Control Canceled</p>	<ul style="list-style-type: none"><li>* Cruise control cannot be activated as not all activation conditions are fulfilled.<ul style="list-style-type: none"><li>► Observe the activation conditions for cruise control.</li></ul></li></ul>
<p data-bbox="144 586 408 612">Cruise Control Inoperative</p>	<ul style="list-style-type: none"><li>* Cruise control has been deactivated. If there is an additional warning tone, cruise control has been switched off automatically (→ page 160).</li><li>* Cruise control is malfunctioning.<ul style="list-style-type: none"><li>► Visit a qualified specialist workshop.</li></ul></li></ul>

## Engine

Display messages	Possible causes/consequences and ► Solutions
<p>Check Coolant Level See Operator's Manual</p>	<p>* The coolant level is too low.</p> <div style="border: 1px solid gray; padding: 5px; margin-bottom: 5px;"> <p><b>!</b> <b>NOTE</b> Engine damage due to insufficient coolant</p> <p>► Avoid long journeys with insufficient coolant.</p> </div> <p>► Add coolant.</p>
<div style="text-align: center; margin-bottom: 5px;">  </div> <p>Coolant Too Hot Stop Vehicle Turn Engine Off</p>	<p>* The coolant is too hot.</p> <p>► Pull over and stop the vehicle safely and switch off the engine, paying attention to road and traffic conditions.</p> <div style="background-color: #f0f0f0; padding: 5px; margin-bottom: 5px;"> <p><b>⚠</b> <b>WARNING</b> Danger of burns when opening the hood</p> <p>If you open the hood when the engine has overheated or during a fire in the engine compartment, you could come into contact with hot gases or other escaping operating fluids.</p> <p>► Before opening the hood, allow the engine to cool down.</p> <p>► In the event of a fire in the engine compartment, keep the hood closed and call the fire service.</p> </div> <p>► Wait until the engine has cooled down.</p> <p>► Make sure that the air supply to the radiator is not obstructed.</p> <p>► Avoiding high loads on the engine, drive on to the nearest qualified specialist workshop. In doing so, ensure that the coolant temperature display remains below the red area.</p>

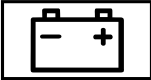

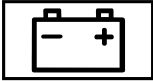
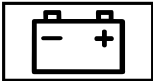

## 422 Display messages and warning/indicator lamps

Display messages	Possible causes/consequences and ► Solutions
 <p>See Operator's Manual</p>	<p>* The battery is not being charged.</p> <div data-bbox="500 294 1646 412"><p><b>!</b> <b>NOTE</b> Possible engine damage if you continue driving</p><ul style="list-style-type: none"><li>► Do not continue driving under any circumstances.</li><li>► Consult a qualified specialist workshop.</li></ul></div> <ul style="list-style-type: none"><li>► Pull over and stop the vehicle safely and switch off the engine, paying attention to road and traffic conditions.</li><li>► Consult a qualified specialist workshop.</li></ul>
 <p>Start Engine See Operator's Manual</p>	<p>* The engine is off and the battery charge level is too low.</p> <ul style="list-style-type: none"><li>► Switch off electrical consumers that are not required.</li><li>► Leave the engine running for a few minutes, or drive for a longer distance. The battery charges.</li></ul>



Display messages	Possible causes/consequences and ► Solutions
 <p data-bbox="194 347 443 393">Stop Vehicle See Operator's Manual</p>	<p data-bbox="526 248 1321 274">* The battery is no longer being charged and the battery charge level is too low.</p> <div data-bbox="563 295 1696 336" style="border: 1px solid black; padding: 5px;"> <p data-bbox="563 300 1136 326"><b>!</b> <b>NOTE</b> Possible engine damage if you continue driving</p> <ul data-bbox="563 341 1108 404" style="list-style-type: none"> <li data-bbox="563 341 1099 367">► Do not continue driving under any circumstances.</li> <li data-bbox="563 372 997 404">► Consult a qualified specialist workshop.</li> </ul> </div> <ul data-bbox="545 429 1690 549" style="list-style-type: none"> <li data-bbox="545 429 1690 481">► Pull over and stop the vehicle safely as soon as possible, paying attention to road and traffic conditions. Do not continue driving under any circumstances.</li> <li data-bbox="545 486 803 512">► Switch off the engine.</li> <li data-bbox="545 518 979 549">► Consult a qualified specialist workshop.</li> </ul>
 <p data-bbox="194 657 462 704">Stop Vehicle Leave Engine Running</p>	<p data-bbox="526 564 896 590">* The battery charge level is too low.</p> <ul data-bbox="545 595 1690 714" style="list-style-type: none"> <li data-bbox="545 595 1690 647">► Pull over and stop the vehicle safely as soon as possible, paying attention to road and traffic conditions. Do not continue driving under any circumstances.</li> <li data-bbox="545 652 840 678">► Leave the engine running.</li> <li data-bbox="545 683 1201 714">► Wait until the display message disappears before pulling away.</li> </ul>

## 424 Display messages and warning/indicator lamps

Display messages	Possible causes/consequences and ► Solutions
 <p data-bbox="144 342 399 391">Check Engine Oil At Next Refueling</p>	<p data-bbox="473 249 1036 270">* The engine oil level has dropped to the minimum level.</p> <div data-bbox="500 294 1646 377" style="border: 1px solid black; padding: 5px;"><p data-bbox="513 301 1221 322">! <b>NOTE</b> Engine damage caused by driving with insufficient engine oil</p><p data-bbox="513 342 1018 363">► Avoid long journeys with insufficient engine oil.</p></div> <p data-bbox="495 394 994 415">► Check the engine oil level when next refueling.</p> <p data-bbox="495 436 846 456">Top up the engine oil (→ page 318).</p> <p data-bbox="495 467 833 487">Notes on engine oil (→ page 389).</p>
 <p data-bbox="144 605 291 625">Fuel Level Low</p>	<p data-bbox="473 511 1009 532">* The fuel supply has dropped into the reserve range.</p> <p data-bbox="495 542 598 563">► Refuel.</p>
 <p data-bbox="144 732 291 753">Gas Cap Loose</p>	<p data-bbox="473 639 1591 684">* There has been pressure loss in the fuel system. The fuel filler cap is not closed correctly or the fuel system is leaking.</p> <p data-bbox="495 695 765 715">► Close the fuel filler cap.</p> <p data-bbox="495 726 1448 746">► <b>If the fuel filler cap was already properly closed:</b> consult a qualified specialist workshop.</p>
 <p data-bbox="144 864 291 884"></p>	<p data-bbox="473 770 759 791">* The fan motor is defective.</p> <p data-bbox="495 801 1646 847">► Avoiding high loads on the engine, drive on to the nearest qualified specialist workshop. In doing so, ensure that the coolant temperature display remains below the red marking.</p>

## Tires

Display messages	Possible causes/consequences and ► Solutions
Check Tire Pressure Soon	<p>* Canada only: The tire pressure loss warning system has detected a significant loss in pressure.</p> <p><b>▲ WARNING</b> Risk of an accident due to insufficient tire pressure</p> <p>Tire pressures that are too low pose the following hazards:</p> <ul style="list-style-type: none"><li>• The tires may burst, especially as the load and vehicle speed increase.</li><li>• The tires may wear excessively and/or unevenly, which may greatly impair tire traction.</li><li>• The driving characteristics, as well as steering and braking, may be greatly impaired.</li></ul> <p>You could then lose control of the vehicle.</p> <ul style="list-style-type: none"><li>► Observe the recommended tire pressure.</li><li>► Adjust the tire pressure if necessary.</li></ul> <p>► Stop the vehicle, paying attention to road and traffic conditions.</p> <p>► Check the tire pressure and the tires.</p> <p>► When the tire pressure is correct, restart the tire pressure loss warning system.</p>

## 426 Display messages and warning/indicator lamps

Display messages	Possible causes/consequences and ► Solutions
Check Tire Pressure Then Restart Run Flat Indicator	<ul style="list-style-type: none"><li>* Canada only: The tire pressure loss warning system generated a display message and has not been restarted since. ► When the tire pressure is correct, restart the tire pressure loss warning system.</li></ul>
Run Flat Indicator Inoperative	<ul style="list-style-type: none"><li>* Canada only: The tire pressure loss warning system is malfunctioning. ► Visit a qualified specialist workshop.</li></ul>
 Please Correct Tire Pressure	<ul style="list-style-type: none"><li>* The tire pressure is too low in at least one of the tires, or the tire pressure difference between the wheels is too great. ► Check the tire pressure and add air, if necessary. ► When the tire pressure is correct, restart the tire pressure monitoring system.</li></ul>

Display messages	Possible causes/consequences and ► Solutions
 <p data-bbox="199 341 317 367">Check Tires</p>	<p data-bbox="526 248 1506 274">* The tire pressure in one or more tires has dropped significantly. The wheel position is displayed.</p> <div data-bbox="545 290 1690 590"><p data-bbox="563 300 1228 326"><b>▲ WARNING</b> Risk of an accident due to insufficient tire pressure</p><p data-bbox="563 341 1145 367">Tire pressures that are too low pose the following hazards:</p><ul data-bbox="563 378 1469 471" style="list-style-type: none"><li>• The tires may burst, especially as the load and vehicle speed increase.</li><li>• The tires may wear excessively and/or unevenly, which may greatly impair tire traction.</li><li>• The driving characteristics, as well as steering and braking, may be greatly impaired.</li></ul><p data-bbox="563 486 979 512">You could then lose control of the vehicle.</p><ul data-bbox="563 523 1007 585" style="list-style-type: none"><li>► Observe the recommended tire pressure.</li><li>► Adjust the tire pressure if necessary.</li></ul></div> <p data-bbox="545 606 1219 631">► Stop the vehicle, paying attention to road and traffic conditions.</p> <p data-bbox="545 642 951 668">► Check the tire pressure and the tires.</p>

Display messages	Possible causes/consequences and ► Solutions
 <p data-bbox="144 342 399 366">Warning Tire Malfunction</p>	<p data-bbox="476 249 1421 273">* The tire pressure in one or more tires has dropped suddenly. The wheel position is displayed.</p> <div data-bbox="500 291 1648 555" style="border: 1px solid gray; padding: 5px;"> <p data-bbox="513 301 1130 325">▲ <b>WARNING</b> Risk of an accident from driving with a flat tire</p> <p data-bbox="513 339 968 363">Flat tires are dangerous in the following ways:</p> <ul data-bbox="519 377 1387 433" style="list-style-type: none"> <li data-bbox="519 377 944 400">• The tires can overheat and cause a fire.</li> <li data-bbox="519 410 1387 433">• The driving characteristics, as well as steering and braking, may be greatly impaired.</li> </ul> <p data-bbox="513 451 931 475">You could then lose control of the vehicle.</p> <ul data-bbox="513 487 857 543" style="list-style-type: none"> <li data-bbox="513 487 820 511">► Do not drive with a flat tire.</li> <li data-bbox="513 521 857 543">► Observe the notes on flat tires.</li> </ul> </div> <p data-bbox="495 573 824 597">Notes on flat tires (→ page 332).</p> <ul data-bbox="495 610 1166 666" style="list-style-type: none"> <li data-bbox="495 610 1166 634">► Stop the vehicle, paying attention to road and traffic conditions.</li> <li data-bbox="495 643 685 666">► Check the tires.</li> </ul>
<p data-bbox="144 687 389 736">Tire Press. Monitor Currently Unavailable</p>	<p data-bbox="476 681 1624 729">* No signals can be received from the tire pressure sensors due to strong radio signal source interference. The tire pressure monitoring system is temporarily unavailable.</p> <ul data-bbox="495 741 1522 790" style="list-style-type: none"> <li data-bbox="495 741 1522 790">► Drive on. The tire pressure monitoring system restarts automatically as soon as the cause has been rectified.</li> </ul>

Display messages	Possible causes/consequences and ► Solutions
 <p>Wheel Sensor(s) Missing</p>	<ul style="list-style-type: none"> <li>* There is no signal from the tire pressure sensor of one or more tires. The pressure of the affected tire is not displayed.                             <ul style="list-style-type: none"> <li>► Have the defective tire pressure sensor replaced at a qualified specialist workshop.</li> </ul> </li> </ul>
<p>Tire Pressure Monitor Inoperative No Wheel Sensors</p>	<ul style="list-style-type: none"> <li>* The wheels installed do not have suitable tire pressure sensors. The tire pressure monitoring system is deactivated.                             <ul style="list-style-type: none"> <li>► Install wheels with suitable tire pressure sensors.</li> </ul> </li> </ul>
<p>Tire Press. Monitor Inoperative</p>	<ul style="list-style-type: none"> <li>* The tire pressure monitoring system is defective.                             <div style="border: 1px solid gray; padding: 10px; margin-top: 10px;"> <p><b>⚠ WARNING</b> There is a risk of an accident if the tire pressure monitoring system is malfunctioning</p> <p>If the tire pressure monitoring system is malfunctioning, it is not able to issue a warning if there is pressure loss in one or more of the tires.</p> <p>Underinflated tires may, for example, impair the driving, steering and braking characteristics.</p> <ul style="list-style-type: none"> <li>► Have the tire pressure monitoring system checked at a qualified specialist workshop.</li> </ul> </div> <ul style="list-style-type: none"> <li>► Visit a qualified specialist workshop.</li> </ul> </li> </ul>
<p>Tires Overheated</p>	<ul style="list-style-type: none"> <li>* At least one tire is overheating. The affected tires are displayed in red. At temperatures close to the limit value, the tires are displayed in yellow.                             <ul style="list-style-type: none"> <li>► Drive more slowly.</li> </ul> </li> </ul>



## 430 Display messages and warning/indicator lamps

Display messages	Possible causes/consequences and ► Solutions
<p>Tires Overheated Decrease Speed</p>	<p>* At least one tire is overheating.</p> <div data-bbox="495 291 1648 412"><p><b>▲ WARNING</b> Risk of an accident from driving with overheated tires</p><p>Overheated tires may burst, particularly at high speeds.</p><p>► Reduce speed so that the tires cool down.</p></div> <p>► Reduce speed so that the tires cool down.</p>

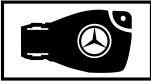
## SmartKey

Display messages	Possible causes/consequences and ► Solutions
 <p>Obtain a New Key</p>	<p>* The SmartKey needs to be replaced.</p> <p>► Visit a qualified specialist workshop.</p>
 <p>Replace Key Battery</p>	<p>* The SmartKey battery is discharged.</p> <p>► Replace the battery.</p>



Display messages	Possible causes/consequences and ► Solutions
 <p>Key Not Detected (white display message)</p>	<p>* The SmartKey is currently undetected.</p> <ul style="list-style-type: none"> <li>► Change the location of the SmartKey in the vehicle.</li> <li>► If the SmartKey is still not recognized, start the engine with the SmartKey in the stowage compartment.</li> </ul>
 <p>Key Not Detected (red display message)</p>	<p>* The SmartKey cannot be detected and may no longer be in the vehicle. The SmartKey is no longer in the vehicle and you switch off the engine:</p> <ul style="list-style-type: none"> <li>• you can no longer start the engine.</li> <li>• you cannot centrally lock the vehicle.</li> </ul> <p>► Ensure that the SmartKey is in the vehicle.</p> <p>If the SmartKey detection function has a malfunction due to a strong radio signal source:</p> <ul style="list-style-type: none"> <li>► Pull over and stop the vehicle safely as soon as possible, paying attention to road and traffic conditions.</li> <li>► Place the SmartKey in the stowage compartment for starting the engine with the SmartKey.</li> </ul>
 <p>Don't Forget Your Key</p>	<p>* A warning tone also sounds. This message reminds you to take your SmartKey with you when you leave the vehicle.</p>

## 432 Display messages and warning/indicator lamps

Display messages	Possible causes/consequences and ► Solutions
 <p>Place the Key in the Marked Space See Operator's Manual</p>	<ul style="list-style-type: none"><li>* The SmartKey detection function is malfunctioning.<ul style="list-style-type: none"><li>► Change the location of the SmartKey in the vehicle.</li><li>► Start the vehicle with the SmartKey in the stowage compartment.</li></ul></li></ul>



### Vehicle

Display messages	Possible causes/consequences and ► Solutions
Apply Brake to Shift from 'P'	<ul style="list-style-type: none"><li>* You have attempted to shift the transmission out of position <b>P</b> and into another transmission position.<ul style="list-style-type: none"><li>► Depress the brake pedal.</li></ul></li></ul>
To Deselect P or N, Depress Brake and Start Engine	<ul style="list-style-type: none"><li>* You have attempted to shift the transmission out of position <b>P</b> or <b>N</b> into another transmission position.<ul style="list-style-type: none"><li>► Depress the brake pedal.</li><li>► Start the engine.</li></ul></li></ul>
Driver's Door Open & Transmission Not in P Risk of Vehicle Rolling Away	<ul style="list-style-type: none"><li>* The driver's door is not fully closed and the transmission is in position <b>R</b>, <b>N</b> or <b>D</b>.<ul style="list-style-type: none"><li>► Shift the transmission to position <b>P</b> when you park the vehicle.</li></ul></li></ul>

Display messages	Possible causes/consequences and ► Solutions
<p>N Permanently Active Risk of Rolling Away</p>	<ul style="list-style-type: none"> <li>* While the vehicle is rolling or while you are driving, the transmission has been shifted to position <b>N</b>.                             <ul style="list-style-type: none"> <li>► Depress the brake pedal to stop and, when the vehicle is stationary, shift the transmission to position <b>P</b>.</li> <li>► To continue your journey, shift the transmission to position <b>D</b> or <b>R</b>.</li> </ul> </li> </ul>
<p>Only Shift to 'P' when Vehicle is Stationary</p>	<ul style="list-style-type: none"> <li>* The transmission can be shifted to position <b>P</b> only when the vehicle is stationary.</li> </ul>
<p>Service Required Do Not Shift Gears Visit Dealer</p>	<ul style="list-style-type: none"> <li>* The transmission is malfunctioning. The transmission position can no longer be shifted.                             <ul style="list-style-type: none"> <li>► When the transmission is in position <b>D</b>, consult a qualified specialist workshop and do not shift the transmission position.</li> <li>► For all other transmission positions, park the vehicle safely.</li> <li>► Consult a qualified specialist workshop or breakdown service.</li> </ul> </li> </ul>
<div style="text-align: center;">  </div> <p>Vehicle Operational Switch the Ignition Off Before Exiting</p>	<ul style="list-style-type: none"> <li>* You are leaving the vehicle when it is in a ready-to-drive state.                             <ul style="list-style-type: none"> <li>► When you leave the vehicle, switch off the ignition and take the SmartKey with you.</li> <li>► If you do not leave the vehicle, switch off the electrical consumers, e.g. the seat heating. Otherwise, the 12 V battery may discharge and it will then be possible to start the vehicle only using a donor battery (starting assistance).</li> </ul> </li> </ul>

#### 434 Display messages and warning/indicator lamps



Display messages	Possible causes/consequences and ► Solutions
Transmission Malfunction Stop	<ul style="list-style-type: none"><li>* The transmission is malfunctioning. The transmission shifts to position <b>N</b> automatically.<ul style="list-style-type: none"><li>► Pull over and stop the vehicle safely as soon as possible, paying attention to road and traffic conditions.</li><li>► Switch the transmission to position <b>P</b>.</li><li>► Consult a qualified specialist workshop.</li></ul></li></ul>
Reversing Not Possible Service Required	<ul style="list-style-type: none"><li>* The transmission is malfunctioning. Reverse gear can no longer be engaged.<ul style="list-style-type: none"><li>► Visit a qualified specialist workshop.</li></ul></li></ul>
Stop Vehicle Leave Engine Running Wait Transmission Cooling	<ul style="list-style-type: none"><li>* The transmission is overheating. Pulling away may be temporarily impaired or not possible.<ul style="list-style-type: none"><li>► Pull over and stop the vehicle safely as soon as possible, paying attention to road and traffic conditions. Do not continue driving under any circumstances.</li><li>► Leave the engine running.</li><li>► Wait until the display message disappears before pulling away.</li></ul></li></ul>
Auxiliary Battery Malfunction	<ul style="list-style-type: none"><li>* The auxiliary battery for the transmission is no longer being charged.<ul style="list-style-type: none"><li>► Visit a qualified specialist workshop.</li><li>► Until then, always manually set the transmission to position <b>P</b> before you switch off the engine.</li><li>► Before leaving the vehicle, apply the electric parking brake.</li></ul></li></ul>
Air Conditioning Malfunction See Operator's Manual	<ul style="list-style-type: none"><li>* Operation of the climate control system is temporarily restricted. Airflow and fresh air supply are set to automatic mode.<ul style="list-style-type: none"><li>► Have the climate control system checked at a qualified specialist workshop.</li></ul></li></ul>

Display messages	Possible causes/consequences and ► Solutions
<p>To Engage Transmiss. Position R First Depress the Brake</p>	<ul style="list-style-type: none"> <li>* You have attempted to shift the transmission out of position <b>D</b> and into transmission position <b>R</b>.               <ul style="list-style-type: none"> <li>► Depress the brake pedal.</li> <li>► Switch the transmission to position <b>R</b>.</li> </ul> </li> </ul>
<div style="border: 1px solid black; padding: 5px; text-align: center;">  </div> <p>Example: Front Left Seat Backrest Not Locked</p>	<ul style="list-style-type: none"> <li>* The seat backrest of the corresponding front seat is not engaged.               <ul style="list-style-type: none"> <li>► Push the seat backrest back until it engages.</li> </ul> </li> </ul>
<div style="border: 1px solid black; padding: 5px; text-align: center;">  </div> <p>Steering Malfunction Drive Carefully Service Required</p>	<ul style="list-style-type: none"> <li>* The power assistance for the steering is malfunctioning. You may need to use more force to steer.               <ul style="list-style-type: none"> <li>► Drive on carefully.</li> <li>► Visit a qualified specialist workshop.</li> </ul> </li> </ul>

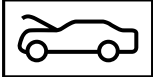
Display messages	Possible causes/consequences and ► Solutions
<p>Let fresh air into the vehicle interior. Air Conditioning Malf. Visit Workshop</p>	<p>* The climate control system is malfunctioning.</p> <div data-bbox="495 291 1644 436" style="border: 1px solid black; padding: 5px;"> <p><b>▲ WARNING</b> Risk of injury and accident due to an insufficient supply of fresh air</p> <p>If the climate control system is malfunctioning, carbon dioxide levels may increase in the vehicle interior. Breathing in carbon dioxide may cause dizziness.</p> <ul style="list-style-type: none"> <li>► Open the window to ensure that there is a sufficient supply of fresh air.</li> </ul> </div> <ul style="list-style-type: none"> <li>► Open the window to ensure that there is an adequate supply of fresh air.</li> <li>► Consult a qualified specialist workshop immediately.</li> </ul>
<div data-bbox="155 526 312 609" style="border: 1px solid black; padding: 5px; text-align: center;">  </div> <p>Steering Malfunction Stop Immediately See Operator's Manual</p>	<p>* The steering is malfunctioning. Steering capability is considerably impaired.</p> <div data-bbox="495 567 1644 743" style="border: 1px solid black; padding: 5px;"> <p><b>▲ WARNING</b> Risk of accident if steering capability is impaired</p> <p>If the steering does not function as intended, the vehicle's operating safety is jeopardized.</p> <ul style="list-style-type: none"> <li>► Pull over and stop the vehicle safely as soon as possible, paying attention to road and traffic conditions. Do not continue driving under any circumstances.</li> <li>► Consult a qualified specialist workshop.</li> </ul> </div> <ul style="list-style-type: none"> <li>► Pull over and stop the vehicle safely as soon as possible, paying attention to road and traffic conditions. Do not continue driving under any circumstances.</li> <li>► Consult a qualified specialist workshop.</li> </ul>

Display messages	Possible causes/consequences and ► Solutions
 <p data-bbox="195 344 449 419">Steering Malfunction Increased Physical Effort See Operator's Manual</p>	<p data-bbox="524 249 1105 275">* The power assistance for the steering is malfunctioning.</p> <div data-bbox="561 298 1698 443" style="border: 1px solid gray; padding: 5px;"> <p data-bbox="561 301 1299 327"><b>▲ WARNING</b> Risk of an accident due to altered steering characteristics</p> <p data-bbox="561 339 1637 365">If the power assistance of the steering fails partially or completely, you will need to use more force to steer.</p> <ul style="list-style-type: none"> <li data-bbox="561 376 1049 401">▶ If safe steering is possible, drive on carefully.</li> <li data-bbox="561 412 1197 438">▶ Visit or consult a qualified specialist workshop immediately.</li> </ul> </div> <ul style="list-style-type: none"> <li data-bbox="543 464 1031 490">▶ If safe steering is possible, drive on carefully.</li> <li data-bbox="543 500 1179 526">▶ Visit or consult a qualified specialist workshop immediately.</li> </ul>
<p data-bbox="195 541 449 591">Active Hood Malfunction See Operator's Manual</p>	<p data-bbox="524 536 1622 562">* The active hood (pedestrian protection) is malfunctioning or inoperative after having already been triggered.</p> <ul style="list-style-type: none"> <li data-bbox="543 572 944 598">▶ Visit a qualified specialist workshop.</li> </ul>
	<p data-bbox="524 607 726 632">* The hood is open.</p> <div data-bbox="561 655 1698 800" style="border: 1px solid gray; padding: 5px;"> <p data-bbox="561 658 1328 684"><b>▲ WARNING</b> Risk of accident if the engine hood is unlatched while driving</p> <p data-bbox="561 697 1458 723">An unlocked engine hood may open up when the vehicle is in motion and block your view.</p> <ul style="list-style-type: none"> <li data-bbox="561 733 1042 759">▶ Never unlatch the engine hood while driving.</li> <li data-bbox="561 769 1169 795">▶ Before every trip, ensure that the engine hood is latched.</li> </ul> </div> <ul style="list-style-type: none"> <li data-bbox="543 821 1147 847">▶ Pull over and stop the vehicle safely as soon as possible.</li> <li data-bbox="543 857 741 883">▶ Close the hood.</li> </ul>

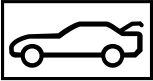
## 438 Display messages and warning/indicator lamps

Display messages	Possible causes/consequences and ► Solutions
	<ul style="list-style-type: none"><li>* At least one door is open.<ul style="list-style-type: none"><li>► Close all doors.</li></ul></li></ul>
	<ul style="list-style-type: none"><li>* The trunk lid is open.<div data-bbox="497 420 1650 601" style="border: 1px solid gray; padding: 5px;"><p><b>⚠ WARNING</b> Risk of exhaust gas poisoning</p><p>Combustion engines emit poisonous exhaust gases such as carbon monoxide. Exhaust gases can enter the vehicle interior if the trunk lid is open when the engine is running, especially if the vehicle is in motion.</p><ul style="list-style-type: none"><li>► Always switch off the engine before opening the trunk lid.</li><li>► Never drive with the trunk lid open.</li></ul></div><ul style="list-style-type: none"><li>► Close the trunk lid.</li></ul></li></ul>
 <p data-bbox="144 746 376 799">Rear Left Backrest Not Latched (Example)</p>	<ul style="list-style-type: none"><li>* The corresponding seat backrest of the rear bench seat is not engaged.<ul style="list-style-type: none"><li>► Fold the corresponding seat backrest back until it engages.</li></ul></li></ul>





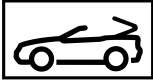

Display messages	Possible causes/consequences and ► Solutions
 <p data-bbox="195 342 399 365">Check Washer Fluid</p>	<ul style="list-style-type: none"> <li>* The washer fluid level in the washer fluid reservoir has dropped below the minimum.               <ul style="list-style-type: none"> <li>► Top up the washer fluid.</li> </ul> </li> </ul>

### Soft top

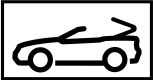
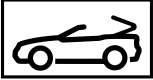

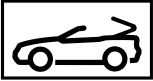
Display messages	Possible causes/consequences and ► Solutions
 <p data-bbox="195 598 399 648">Malfunction Service Required</p>	<ul style="list-style-type: none"> <li>* The roll bars are defective.               <ul style="list-style-type: none"> <li>► Visit a qualified specialist workshop immediately.</li> </ul> </li> </ul>
 <p data-bbox="195 756 439 806">Start Engine See Operator's Manual</p>	<ul style="list-style-type: none"> <li>* The on-board electrical system voltage is too low.               <ul style="list-style-type: none"> <li>► Start the engine.</li> </ul> </li> </ul>





#### 440 Display messages and warning/indicator lamps

Display messages	Possible causes/consequences and ► Solutions
 <p data-bbox="144 342 393 391">Open/Close Convertible Top Completely</p>	<ul style="list-style-type: none"><li>* The soft top is not locked. If you drive at speeds of more than 35 mph (60 km/h) you cannot open or close the soft top.<ul style="list-style-type: none"><li>► Pull over and stop the vehicle safely as soon as possible, paying attention to road and traffic conditions.</li><li>► Push or pull and hold the soft-top switch until the soft top is fully open or closed.</li></ul></li></ul>
 <p data-bbox="144 500 404 522">Convertible Top Lowering</p>	<ul style="list-style-type: none"><li>* The soft top is not fully opened or closed. The hydraulics are depressurizing.<ul style="list-style-type: none"><li>► Fully open or close the soft top.</li></ul></li></ul>
 <p data-bbox="144 629 412 678">Convertible Top Operation Possible to 35 mph</p>	<ul style="list-style-type: none"><li>* If you drive at speeds of more than 35 mph (60 km/h) you cannot open or close the soft top.<ul style="list-style-type: none"><li>► Do not drive faster than 35 mph (60 km/h).</li><li>► Fully open or close the soft top.</li></ul></li></ul>
 <p data-bbox="144 785 413 861">While stationary, apply the brakes before operating the soft top.</p>	<ul style="list-style-type: none"><li>* The vehicle is stationary and you try to open or close the soft top.<ul style="list-style-type: none"><li>► Depress the brake pedal.</li><li>► Push or pull the soft top switch again until the soft top is fully open or closed.</li></ul></li></ul>

Display messages	Possible causes/consequences and ► Solutions
 <p data-bbox="195 342 408 366">Trunk Partition Open</p>	<p data-bbox="513 249 831 273">* The trunk separator is open.</p> <ul style="list-style-type: none"> <li data-bbox="541 283 842 307">► Close the trunk separator.</li> </ul>

## Lights

Display messages	Possible causes/consequences and ► Solutions
 <p data-bbox="195 596 362 647">Check Left Low Beam (Example)</p>	<p data-bbox="513 503 981 527">* The corresponding light source is defective.</p> <ul style="list-style-type: none"> <li data-bbox="541 537 944 561">► Visit a qualified specialist workshop.</li> <li data-bbox="541 571 1702 622">ⓘ LED light bulbs: the display message for the corresponding lamp appears only when all the light-emitting diodes in the lamp have failed.</li> </ul>
 <p data-bbox="195 754 469 804">Active Headlamps Inoperative</p>	<p data-bbox="513 660 905 684">* The active headlamps are defective.</p> <ul style="list-style-type: none"> <li data-bbox="541 695 944 718">► Visit a qualified specialist workshop.</li> </ul>

Display messages	Possible causes/consequences and ► Solutions
 <p>Malfunction See Operator's Manual</p>	<ul style="list-style-type: none"> <li>* The exterior lighting is defective.                             <ul style="list-style-type: none"> <li>► Visit a qualified specialist workshop.</li> </ul> </li> </ul>
 <p>Auto Lamp Function Inoperative</p>	<ul style="list-style-type: none"> <li>* The light sensor is defective.                             <ul style="list-style-type: none"> <li>► Visit a qualified specialist workshop.</li> </ul> </li> </ul>
 <p>Switch Off Lights</p>	<ul style="list-style-type: none"> <li>* You are leaving the vehicle and the lights are still switched on.                             <ul style="list-style-type: none"> <li>► Turn the light switch to the <b>AUTO</b> position.</li> </ul> </li> </ul>
 <p>Switch On Headlamps</p>	<ul style="list-style-type: none"> <li>* You are driving without low-beam headlamps.                             <ul style="list-style-type: none"> <li>► Turn the light switch to the  or <b>AUTO</b> position.</li> </ul> </li> </ul>
<p>Adaptive Highbeam Assist Inoperative</p>	<ul style="list-style-type: none"> <li>* Adaptive Highbeam Assist is malfunctioning.                             <ul style="list-style-type: none"> <li>► Visit a qualified specialist workshop.</li> </ul> </li> </ul>

Display messages	Possible causes/consequences and ► Solutions
<p>Adaptive Highbeam Assist Currently Unavailable See Operator's Manual</p>	<p>* Adaptive Highbeam Assist is temporarily unavailable. The system limitations have been reached (→ page 114).</p> <p>► Drive on. Once the cause of the problem is no longer present, the system will be available again. The <a href="#">Adaptive Highbeam Assist Now Available</a> display message appears.</p>
<p>Adaptive Highbeam Assist Camera View Restricted See Operator's Manual</p>	<p>* The camera view is restricted. Possible causes are:</p> <ul style="list-style-type: none"> <li>• dirt on the windshield in the camera's field of vision</li> <li>• heavy rain, snow or fog</li> </ul> <p>Driving systems and driving safety systems may be malfunctioning or temporarily unavailable. Once the cause of the problem is no longer present, driving systems and driving safety systems will become available again.</p> <p>If the display message does not disappear:</p> <p>► Pull over and stop the vehicle safely as soon as possible, paying attention to road and traffic conditions.</p> <p>► Clean the windshield.</p>

## Warning and indicator lamps

### Overview of warning and indicator lamps

Some systems perform a self-test when the ignition is switched on. Some warning and indicator

lamps may briefly light up or flash. This behaviour is non-critical. These warning and indicator lamps indicate a malfunction only if they light up or flash after the engine is started or during a journey.

## 444 Display messages and warning/indicator lamps

### Instrument Display (standard)

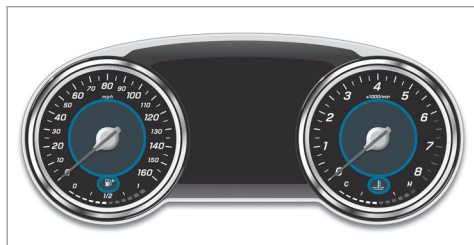

### Instrument Display in the Widescreen Cockpit

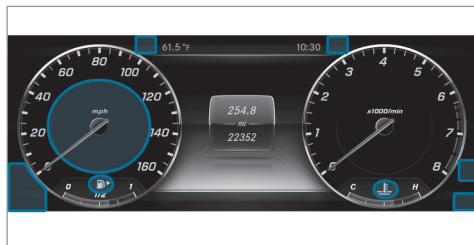





### Progressive setting in the Widescreen Cockpit



If you select the progressive display setting in vehicles with a Widescreen Cockpit, the positions of the indicator lamps on the Instrument Display change.

#### Warning and indicator lamps:

-  Low beam (→ page 111)
-  Parking lights (→ page 111)
-  High beam (→ page 112)
-  Turn signal light (→ page 112)
-  Rear fog lights (→ page 111)



Seat belt is not fastened  
(→ page 453)



USA: brakes (red) (→ page 446)



Canada: brakes (red) (→ page 446)



ABS malfunction (→ page 446)



AIR BODY CONTROL malfunction  
(→ page 453)



ESP® (→ page 446)



ESP® OFF (→ page 446)



USA: electric parking brake applied  
(red) (→ page 446)



Canada: electric parking brake  
applied (red) (→ page 446)



Electric parking brake (yellow)  
(→ page 446)



Steering assistance malfunction  
(→ page 454)



Electrical fault (→ page 455)



Restraint system (→ page 446)



Check Engine (→ page 455)



Fuel reserve with fuel filler flap location indicator (→ page 455)



Coolant too hot/cold (→ page 455)



Distance warning (→ page 453)





Tire pressure monitoring system (→ page 459)

## Safety systems

Warning/indicator lamp	Possible causes/consequences and ► Solutions
<div data-bbox="153 291 310 373" data-label="Image"> </div> <p data-bbox="144 381 408 407">Brake warning lamp (USA)</p> <div data-bbox="153 412 310 495" data-label="Image"> </div> <p data-bbox="144 502 408 552">Brakes warning lamp (Canada)</p>	<p data-bbox="458 288 1138 313">The red brake system warning lamp is lit while the engine is running.</p> <p data-bbox="458 324 657 350">Possible causes are:</p> <ul data-bbox="458 360 1406 417" style="list-style-type: none"> <li data-bbox="458 360 1406 386">• The brake force boosting is malfunctioning and the braking characteristics may be affected.</li> <li data-bbox="458 391 1073 417">• There is insufficient brake fluid in the brake fluid reservoir.</li> </ul> <div data-bbox="458 438 1644 474" data-label="Section-Header"> <p><b>▲ WARNING</b> There is a risk of an accident if brake force boosting is malfunctioning</p> </div> <p data-bbox="458 484 1613 536">If brake force boosting is malfunctioning, increased brake pedal force may be necessary for braking. Braking characteristics may be impaired. The braking distance in an emergency braking situation can increase.</p> <ul data-bbox="458 547 1581 629" style="list-style-type: none"> <li data-bbox="458 547 1581 598">► Pull over and stop the vehicle safely as soon as possible, paying attention to road and traffic conditions. Do not continue driving under any circumstances.</li> <li data-bbox="458 603 907 629">► Consult a qualified specialist workshop.</li> </ul> <div data-bbox="458 666 1644 702" data-label="Section-Header"> <p><b>▲ WARNING</b> Risk of an accident due to low brake fluid level</p> </div> <p data-bbox="458 712 1474 733">If the brake fluid level is too low, the braking effect and the braking characteristics may be impaired.</p> <ul data-bbox="458 743 1581 852" style="list-style-type: none"> <li data-bbox="458 743 1581 795">► Pull over and stop the vehicle safely as soon as possible, paying attention to road and traffic conditions. Do not continue driving under any circumstances.</li> <li data-bbox="458 800 907 852">► Consult a qualified specialist workshop. Do not add brake fluid.</li> </ul>



Warning/indicator lamp	Possible causes/consequences and ► Solutions
	<ul style="list-style-type: none"><li>► Pull over and stop the vehicle safely as soon as possible, paying attention to road and traffic conditions. Do not continue driving under any circumstances.</li><li>► Observe the messages on the multifunction display.</li><li>► Consult a qualified specialist workshop.</li></ul> <p><b>USA only:</b> if an additional display message appears with the  symbol on the multifunction display, the brake pads have reached their wear limit.</p> <ul style="list-style-type: none"><li>► Visit a qualified specialist workshop.</li></ul>

Warning/indicator lamp	Possible causes/consequences and ► Solutions
 <p data-bbox="144 342 328 366">ABS warning lamp</p>	<p data-bbox="452 249 1073 377">The yellow ABS warning lamp is lit while the engine is running. ABS is malfunctioning. If there is an additional warning tone, EBD is malfunctioning. Other driving and driving safety systems may also be faulty.</p> <div data-bbox="452 394 1646 609" style="border: 1px solid gray; padding: 5px;"> <p data-bbox="467 405 1184 428"><b>▲ WARNING</b> There is risk of skidding if EBD or ABS is malfunctioning</p> <p data-bbox="467 443 1156 467">If EBD or ABS is malfunctioning, the wheels could lock when braking</p> <p data-bbox="467 477 1585 529">The steering capability and braking characteristics are thus severely impaired. The braking distance in an emergency braking situation can increase. In addition, other driving safety systems are switched off.</p> <ul data-bbox="467 539 1295 598" style="list-style-type: none"> <li data-bbox="467 539 685 563">► Drive on carefully.</li> <li data-bbox="467 573 1295 598">► Have the brake system checked immediately at a qualified specialist workshop.</li> </ul> </div> <ul data-bbox="452 625 999 718" style="list-style-type: none"> <li data-bbox="452 625 667 649">► Drive on carefully.</li> <li data-bbox="452 659 999 683">► Observe the messages in the multifunction display.</li> <li data-bbox="452 694 851 718">► Visit a qualified specialist workshop.</li> </ul>
 <p data-bbox="144 823 421 847">ESP® warning lamp flashes</p>	<p data-bbox="452 733 1138 795">The yellow ESP® warning lamp flashes while the vehicle is in motion. ESP® is intervening.</p> <ul data-bbox="452 806 1129 829" style="list-style-type: none"> <li data-bbox="452 806 1129 829">► Adapt your driving style to suit the road and weather conditions.</li> </ul>

**Warning/indicator lamp**

ESP® warning lamp lights up

**Possible causes/consequences and ► Solutions**

The yellow ESP® warning lamp is lit while the engine is running.

ESP® is malfunctioning.

Other driving and driving safety systems may also be malfunctioning.

**▲ WARNING** Risk of skidding if ESP® is malfunctioning



If ESP® is malfunctioning, ESP® cannot carry out vehicle stabilization. In addition, other driving safety systems are switched off.

- Drive on carefully.
- Have ESP® checked at a qualified specialist workshop.

- Drive on carefully.
- Observe the messages in the multifunction display.
- Consult a qualified specialist workshop.



## 450 Display messages and warning/indicator lamps

Warning/indicator lamp	Possible causes/consequences and ► Solutions
 <p data-bbox="144 342 389 368">ESP® OFF warning lamp</p>	<p data-bbox="452 249 1134 311">The yellow ESP® OFF warning lamp is lit while the engine is running. ESP® is deactivated.</p> <div data-bbox="452 332 1646 373"><p data-bbox="467 339 1151 368"><b>▲ WARNING</b> Risk of skidding when driving with ESP® deactivated</p></div> <p data-bbox="467 384 1618 433">If ESP® is deactivated, ESP® cannot carry out vehicle stabilization. The availability of further driving safety systems is also limited.</p> <ul data-bbox="467 446 1088 508" style="list-style-type: none"><li data-bbox="467 446 685 470">► Drive on carefully.</li><li data-bbox="467 480 1088 508">► Only deactivate ESP® for as long as the situation requires.</li></ul> <p data-bbox="467 534 997 560">If ESP® cannot be activated, ESP® is malfunctioning.</p> <ul data-bbox="467 570 1180 596" style="list-style-type: none"><li data-bbox="467 570 1180 596">► Have ESP® checked immediately at a qualified specialist workshop.</li></ul> <p data-bbox="452 622 898 649">► Observe the notes on deactivating ESP®.</p>

Warning/indicator lamp	Possible causes/consequences and ► Solutions
<p data-bbox="203 253 360 336"></p> <p data-bbox="194 341 480 419">Red indicator lamp, electric parking brake applied (USA only)</p> <p data-bbox="203 424 360 507"></p> <p data-bbox="194 512 480 590">Red indicator lamp, electric parking brake applied (Canada only)</p> <p data-bbox="203 595 360 678"></p> <p data-bbox="194 683 480 761">Yellow electric parking brake indicator lamp is malfunctioning</p>	<p data-bbox="508 248 1690 300">The red electric parking brake indicator lamp flashes or is lit. The yellow indicator lamp is also lit if the electric parking brake malfunctions.</p> <p data-bbox="508 310 1053 336">► Observe the messages in the multifunction display.</p>

Warning/indicator lamp	Possible causes/consequences and ► Solutions
 <p data-bbox="144 342 402 391">Restraint system warning lamp</p>	<p data-bbox="452 249 1166 308">The red restraint system warning lamp is lit while the engine is running. The restraint system is malfunctioning.</p> <div data-bbox="452 325 1646 498" style="border: 1px solid gray; padding: 5px;"><p data-bbox="465 335 1345 360"><b>▲ WARNING</b> Risk of injury or fatal injury due to a malfunction in the restraint system</p><p data-bbox="465 373 1633 453">If the restraint system is malfunctioning, restraint system components may be triggered unintentionally or might not be triggered at all in the event of an accident. This may affect the Emergency Tensioning Device or airbag, for example.</p><ul data-bbox="465 464 1461 487" style="list-style-type: none"><li>▶ Have the restraint system checked and repaired immediately at a qualified specialist workshop.</li></ul></div> <ul data-bbox="452 515 999 605" style="list-style-type: none"><li>▶ Drive on carefully.</li><li>▶ Observe the messages in the multifunction display.</li><li>▶ Visit a qualified specialist workshop immediately.</li></ul>

## Seat belts

Warning/indicator lamp	Possible causes/consequences and ► Solutions
 <p data-bbox="195 384 426 433">Seat belt warning lamp lights up</p>	<p data-bbox="504 291 1337 314">After the engine is started, the red seat belt warning lamp lights up for six seconds.</p> <p data-bbox="504 325 994 349">In addition, an acoustic warning tone may sound.</p> <p data-bbox="504 359 1424 383">The seat belt warning lamp reminds the driver and front passenger to fasten their seat belts.</p> <ul style="list-style-type: none"> <li data-bbox="504 393 759 417">► Fasten your seat belt.</li> </ul> <p data-bbox="504 436 1480 459">If you have placed objects on the front passenger seat, the seat belt warning lamp may remain lit.</p>
 <p data-bbox="195 570 426 619">Seat belt warning lamp flashes</p>	<p data-bbox="504 477 1310 501">The red seat belt warning lamp flashes and an intermittent warning tone sounds.</p> <p data-bbox="504 511 1415 535">The driver or front passenger has not fastened their seat belt while the vehicle is in motion.</p> <ul style="list-style-type: none"> <li data-bbox="504 545 759 569">► Fasten your seat belt.</li> <li data-bbox="504 569 968 593">There are objects on the front passenger seat.</li> <li data-bbox="504 603 1049 627">► Remove the objects from the front passenger seat.</li> </ul>

## Driving systems

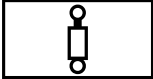
Warning/indicator lamp	Possible causes/consequences and ► Solutions
 <p data-bbox="195 859 454 883">Suspension warning lamp</p>	<p data-bbox="504 766 1021 790">The yellow AIR BODY CONTROL warning lamp is on.</p> <p data-bbox="504 800 800 824">AIR BODY CONTROL is faulty.</p> <ul style="list-style-type: none"> <li data-bbox="504 835 1057 858">► Observe the messages on the multifunction display.</li> </ul>

## 454 Display messages and warning/indicator lamps



Warning/indicator lamp	Possible causes/consequences and ► Solutions
 <p data-bbox="144 342 375 365">Distance warning lamp</p>	<p data-bbox="452 249 1156 272">The red distance warning lamp lights up while the vehicle is in motion.</p> <p data-bbox="452 282 1156 305">The distance to the vehicle in front is too small for the speed selected.</p> <p data-bbox="452 315 1360 338">If there is an additional warning tone, you are approaching an obstacle at too high a speed.</p> <ul data-bbox="452 349 833 409" style="list-style-type: none"><li data-bbox="452 349 833 371">► Be prepared to brake immediately.</li><li data-bbox="452 382 711 405">► Increase the distance.</li></ul> <p data-bbox="452 425 652 448">Active Brake Assist.</p>

## Vehicle

Warning/indicator lamp	Possible causes/consequences and ► Solutions
 <p data-bbox="144 687 375 737">Power steering system warning lamp</p>	<p data-bbox="452 594 1230 617">The red power steering system warning lamp is lit while the engine is running.</p> <p data-bbox="452 627 1147 650">The power steering assistance or the steering itself is malfunctioning.</p> <div data-bbox="452 671 1646 847" style="border: 1px solid gray; padding: 5px;"><p data-bbox="467 681 1114 704"><b>▲ WARNING</b> Risk of accident if steering capability is impaired</p><p data-bbox="467 714 1369 737">If the steering does not function as intended, the vehicle's operating safety is jeopardized.</p><ul data-bbox="467 747 1578 835" style="list-style-type: none"><li data-bbox="467 747 1578 797">► Pull over and stop the vehicle safely as soon as possible, paying attention to road and traffic conditions. Do not continue driving under any circumstances.</li><li data-bbox="467 808 905 830">► Consult a qualified specialist workshop.</li></ul></div> <ul data-bbox="452 866 999 888" style="list-style-type: none"><li data-bbox="452 866 999 888">► Observe the messages in the multifunction display.</li></ul>

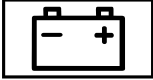

## Engine

Warning/indicator lamp	Possible causes/consequences and ► Solutions
 <p data-bbox="195 410 454 456">Engine diagnosis warning lamp</p>	<p data-bbox="504 314 1221 339">The yellow Check Engine warning lamp is lit while the engine is running.</p> <p data-bbox="504 350 1313 375">A malfunction has occurred in the engine, the exhaust system or the fuel system.</p> <p data-bbox="504 385 1641 410">The emissions limit value may have been exceeded and the engine may be running in emergency operation mode.</p> <p data-bbox="504 420 1692 467">In some states, legal requirements stipulate that you must immediately consult a qualified specialist workshop as soon as the yellow Check Engine warning lamp lights up.</p> <ul style="list-style-type: none"> <li data-bbox="504 477 1341 502">► Have the vehicle checked as soon as possible at a qualified specialist workshop.</li> </ul>
 <p data-bbox="195 610 476 656">Electrical malfunction warning lamp</p>	<p data-bbox="504 519 925 543">The red electrical fault warning lamp is lit.</p> <p data-bbox="504 554 814 579">There is a fault in the electrics.</p> <ul style="list-style-type: none"> <li data-bbox="504 589 1051 614">► Observe the messages in the multifunction display.</li> </ul>
 <p data-bbox="195 765 460 790">Fuel reserve warning lamp</p>	<p data-bbox="504 674 1105 699">The yellow fuel reserve warning lamp lights up while driving.</p> <p data-bbox="504 709 1687 734">There has been pressure loss in the fuel system. The fuel filler cap is not closed correctly or the fuel system is leaking.</p> <ul style="list-style-type: none"> <li data-bbox="504 744 778 769">► Close the fuel filler cap.</li> </ul> <p data-bbox="504 790 1042 815">If the fuel filler cap has already been closed correctly:</p> <ul style="list-style-type: none"> <li data-bbox="504 825 907 850">► Visit a qualified specialist workshop.</li> </ul>

## 456 Display messages and warning/indicator lamps

---

### Warning/indicator lamp



Fuel reserve warning lamp

### Possible causes/consequences and ► Solutions

The yellow fuel reserve warning lamp is lit while the engine is running.

The fuel supply has dropped into the reserve range.

► Refuel.

**Warning/indicator lamp**

Coolant warning lamp

**Possible causes/consequences and ► Solutions**

The red coolant warning lamp is lit while the engine is running.

Possible causes are:

- The temperature sensor is malfunctioning
- Coolant level too low
- The air supply to the radiator is obstructed
- The radiator fan is defective

If there is an additional warning tone, the coolant temperature has exceeded the maximum permissible temperature.

**▲ WARNING** Danger of burns when opening the hood

If you open the hood when the engine has overheated or during a fire in the engine compartment, you could come into contact with hot gases or other escaping operating fluids.

- Before opening the hood, allow the engine to cool down.
- In the event of a fire in the engine compartment, keep the hood closed and call the fire service.

- Pull over and stop the vehicle safely and switch off the engine, paying attention to road and traffic conditions. Do not continue driving under any circumstances.
- Observe the messages in the multifunction display.

If the coolant temperature display is at the lower end of the temperature scale:

- Consult a qualified specialist workshop.

## 458 Display messages and warning/indicator lamps

---

Warning/indicator lamp	Possible causes/consequences and ► Solutions
	<p>Otherwise:</p> <ul style="list-style-type: none"><li>► Leave the vehicle and keep a safe distance from the vehicle until the engine has cooled down.</li><li>► Check the coolant level.</li><li>► Make sure that the air supply to the radiator is not obstructed.</li><li>► Avoiding high loads on the engine, drive on to the nearest qualified specialist workshop. In doing so, ensure that the coolant temperature display remains below the red area.</li></ul>

## Tires

Warning/indicator lamp	Possible causes/consequences and ► Solutions
 <p data-bbox="194 383 471 461">Tire pressure monitoring system warning lamp lights up</p>	<p data-bbox="508 290 1450 347">The yellow tire pressure monitoring system warning lamp (pressure loss/malfunction) is lit. The tire pressure monitoring system has detected tire pressure loss in at least one of the tires.</p> <div data-bbox="508 367 1690 409" style="background-color: #e0e0e0; padding: 5px;"> <p data-bbox="517 372 1191 398">▲ <b>WARNING</b> Risk of an accident due to insufficient tire pressure</p> </div> <p data-bbox="517 414 1108 440">Tire pressures that are too low pose the following hazards:</p> <ul data-bbox="526 450 1432 543" style="list-style-type: none"> <li>• The tires may burst, especially as the load and vehicle speed increase.</li> <li>• The tires may wear excessively and/or unevenly, which may greatly impair tire traction.</li> <li>• The driving characteristics, as well as steering and braking, may be greatly impaired.</li> </ul> <p data-bbox="517 559 942 585">You could then lose control of the vehicle.</p> <ul data-bbox="517 595 970 657" style="list-style-type: none"> <li>► Observe the recommended tire pressure.</li> <li>► Adjust the tire pressure if necessary.</li> </ul> <ul data-bbox="508 678 1182 740" style="list-style-type: none"> <li>► Stop the vehicle, paying attention to road and traffic conditions.</li> <li>► Check the tire pressure and the tires.</li> </ul>

**Warning/indicator lamp**



Tire pressure monitoring system warning lamp flashes

**Possible causes/consequences and ► Solutions**

The yellow tire pressure monitoring system warning lamp (pressure loss/malfunction) flashes for approximately one minute and then remains lit.

The tire pressure monitoring system is malfunctioning.

**▲ WARNING** There is a risk of an accident if the tire pressure monitoring system is malfunctioning

If the tire pressure monitoring system is malfunctioning, it is not able to issue a warning if there is pressure loss in one or more of the tires.

Underinflated tires may, for example, impair the driving, steering and braking characteristics.

► Have the tire pressure monitoring system checked at a qualified specialist workshop.

► Consult a qualified specialist workshop.

**1, 2, 3 ...****12 V socket**

see Socket (12 V)

**48 V on-board electrical system**

Operating safety ..... 22

**360° Camera** ..... 181

Assigning as a favorite ..... 183

Care ..... 327

Function ..... 181

Selecting a view ..... 183

**A****A/C function**

Activating/deactivating (control panel) ..... 125

Activating/deactivating (multimedia system) ..... 125

**ABS (Anti-lock Brake System)** ..... 154**Acceleration**

see Kickdown

**Access data**

Editing ..... 287

Setting ..... 286

**Acoustic locking verification signal**

Activating/deactivating ..... 58

**Active Blind Spot Assist** ..... 193

Activating/deactivating ..... 195

Brake application ..... 193

Function ..... 193

System limitations ..... 193

Towing a trailer ..... 193

**Active Brake Assist**

Function/notes ..... 156

Setting ..... 159

**Active Distance Assist DISTRONIC** ..... 162

Active Emergency Stop Assist ..... 170

Active Lane Change Assist ..... 169

Calling up a speed ..... 164

Function ..... 162

Increasing/decreasing speed ..... 164

Requirements ..... 164

Steering wheel buttons ..... 164

Storing a speed ..... 164

Switching off/deactivating ..... 164

Switching on/activating ..... 164

System limitations ..... 162

**Active Emergency Stop Assist** ..... 170**Active hood (pedestrian protection)** ..... 315

Method of operation ..... 315

Resetting ..... 315

**Active Lane Change Assist**

Function ..... 169

**Active Lane Keeping Assist** ..... 195

Function ..... 195

Sensitivity (function/notes) ..... 198

Setting the sensitivity ..... 198

Switching on/off ..... 197

System limitations ..... 195

**Active Parking Assist** ..... 184

Cross Traffic Alert ..... 189

Drive Away Assist ..... 188

Exiting a parking space ..... 186

Function ..... 184

Parking ..... 185

System limitations ..... 184

**Active Speed Limit Assist** ..... 192

Setting ..... 192

**Active Steering Assist** ..... 167

Activating/deactivating ..... 168

Active Emergency Stop Assist ..... 170

Active Lane Change Assist ..... 169

- Function ..... 167  
System limitations ..... 167
- Adaptive cruise control**  
see Active Distance Assist DISTRONIC
- Adaptive Highbeam Assist**  
Function ..... 114  
Switching on/off ..... 115
- Additives** ..... 389  
Engine oil ..... 389  
Fuel ..... 389
- Additives (engine oil)**  
see Additives
- Additives (fuel)**  
see Fuel
- Address book**  
see Contacts
- Adjusting the balance/fader**  
Burmester® surround sound system .... 313
- Adjusting the sound focus**  
Burmester® surround sound system .... 313
- ADS PLUS damping system**  
see AIR BODY CONTROL
- After-sales service center**  
see ASSYST PLUS
- Air bag** ..... 38  
Activation ..... 32  
Front air bag ..... 38  
Head air bag ..... 38  
Installation locations ..... 38  
Knee air bag ..... 38  
Overview ..... 38  
Protection ..... 39  
Reduced protection ..... 40  
Side impact air bag ..... 38
- AIR BODY CONTROL** ..... 171  
Setting ..... 173  
Suspension ..... 171
- Air conditioning system**  
see Climate control
- Air distribution** ..... 124
- Air freshener system**  
see Fragrance system
- Air pressure**  
see Tire pressure
- Air suspension**  
see AIR BODY CONTROL
- Air vents** ..... 128  
Adjusting (front) ..... 128  
Adjusting (rear passenger compartment) ..... 129  
Adjusting the AIRSCARF vents ..... 130  
Glove box ..... 129
- Air-recirculation mode** ..... 127
- AIRCAP**  
Activating ..... 79  
Deactivating ..... 79
- Airflow** ..... 124
- AIRSCARF**  
Activating/deactivating ..... 94
- AIRSCARF vents**  
Setting ..... 130
- Alarm**  
see Panic alarm
- Alarm system**  
see ATA (anti-theft alarm system)
- Alternative route**  
see Route



- Ambient lighting** ..... 116
- Android Auto** ..... 280
- Connecting a mobile phone ..... 281
  - Ending ..... 281
  - Note ..... 280
  - Overview ..... 280
  - Sound settings ..... 281
  - Transferred vehicle data ..... 282
- Animals**
- Pets in the vehicle ..... 56
- Anti-lock braking system**
- see ABS (Anti-lock Brake System)
- Anti-skid chains**
- see Snow chains
- Anti-theft alarm system**
- see ATA (anti-theft alarm system)
- Anti-theft protection**
- Immobilizer ..... 83
- Anti-theft protection**
- see ATA (anti-theft alarm system)
- Anticipatory occupant protection**
- see PRE-SAFE® (anticipatory occupant protection)
- Apple CarPlay™** ..... 279
- Connecting an iPhone® ..... 279
  - Ending ..... 280
  - Notes ..... 279
  - Overview ..... 279
  - Sound settings ..... 280
  - Transferred vehicle data ..... 282
- Ashtray**
- Front center console ..... 106
  - Rear passenger compartment ..... 107
- Assistance graphic**
- Menu (on-board computer) ..... 204
- Assistance systems**
- see Driving safety system
- ASSYST PLUS** ..... 314
- Displaying the service due date ..... 314
  - Function/notes ..... 314
  - Non-operational times with the battery disconnected ..... 315
  - Regular maintenance work ..... 314
  - Special service requirements ..... 314
- ATA (anti-theft alarm system)** ..... 83
- Deactivating the alarm ..... 84
  - Function ..... 83
- ATTENTION ASSIST** ..... 189, 190
- Function ..... 189
  - Setting ..... 190
  - System limitations ..... 189
- Attention assistant**
- see ATTENTION ASSIST
- Audio mode**
- Activating media mode ..... 294
  - Connecting USB devices ..... 296
  - Copyright ..... 293
  - Information ..... 292
  - Inserting/removing an SD card ..... 294
  - Media search ..... 299
  - Overview ..... 295
  - Pause and playback function ..... 296
  - Selecting a track ..... 296
  - Selecting playback options ..... 296
  - Track list ..... 296
- Authorized workshop**
- see Qualified specialist workshop

- Automatic distance control**  
see Active Distance Assist DISTRONIC
- Automatic driving lights** ..... 112
- Automatic engine start (ECO start/stop function)** ..... 136
- Automatic front passenger front air bag shutoff** ..... 41, 43  
PASSENGER AIR BAG indicator lamp ..... 43
- Automatic front-passenger front air bag deactivation system** ..... 41  
Function of the automatic front passenger air bag shutoff ..... 41
- Automatic mirror folding function**  
Activating/deactivating ..... 123
- Automatic transmission**  
DIRECT SELECT lever ..... 139  
Drive program display ..... 138  
Drive programs ..... 138  
DYNAMIC SELECT switch ..... 138  
Engaging drive position ..... 141  
Engaging reverse gear ..... 140  
Kickdown ..... 142  
Manual gearshifting ..... 141  
Selecting park position ..... 140
- Shifting to neutral ..... 140  
Steering wheel paddle shifters ..... 141  
Transmission position display ..... 139  
Transmission positions ..... 139
- B**
- Bag hook** ..... 103
- BAS (Brake Assist System)** ..... 154
- Battery**  
SmartKey ..... 59
- Battery (vehicle)**  
Charging ..... 340  
Jump-starting ..... 340  
Notes ..... 338
- Belt**  
see Seat belts
- Blind Spot Assist** ..... 193  
Activating/deactivating ..... 195  
Function ..... 193  
System limitations ..... 193
- Blower**  
see Climate control
- Bluetooth®**  
Activating/deactivating ..... 233  
Setting up an Internet connection ..... 286  
Settings ..... 233  
Switching profile (DUN/PAN) ..... 287
- Bluetooth® audio**  
Activating ..... 304  
De-authorizing (de-registering) the device ..... 304  
Information ..... 301  
Overview ..... 302  
Searching for a track ..... 304  
Searching for and authorizing the device ..... 303  
Selecting a music player ..... 304  
Switching device via NFC ..... 304
- Brake Assist System**  
see BAS (Brake Assist System)
- Brake fluid**  
Notes ..... 390
- Brake force distribution**  
EBD (Electronic Brake force Distribution) ..... 155

- Brakes**  
 ABS (Anti-lock Braking System) ..... 154  
 Active Brake Assist ..... 156  
 BAS (Brake Assist System) ..... 154  
 Driving tips ..... 134  
 EBD (Electronic Brake force Distribution) ..... 155  
 HOLD function ..... 170  
 Limited braking effect (salt-treated roads) ..... 134  
 New/replaced brake pads/brake discs ..... 134  
 Notes on breaking-in a new vehicle .... 134
- Braking assistance**  
 see BAS (Brake Assist System)
- Breakdown**  
 Changing a wheel ..... 377  
 Overview of the help functions ..... 16  
 Roadside Assistance ..... 21  
 Tow-starting ..... 348  
 Towing away ..... 344  
 Transporting the vehicle ..... 346
- Breakdown**  
 see Flat tire
- Burmester® surround sound system** .... 312  
 Adjusting the balance/fader ..... 313  
 Adjusting the sound focus ..... 313  
 Adjusting treble, mid-range and bass settings ..... 312  
 Automatic volume adjustment ..... 313  
 Calling up the sound menu ..... 312  
 Information ..... 312  
 Switching the surround sound on/off ..... 313
- Buttons**  
 Steering wheel ..... 200
- C**
- California**  
 Important information for private customers and lessees ..... 22
- Call list**  
 Making a call ..... 277  
 Options in the call list ..... 277  
 Overview ..... 277
- Calling up the sound menu**  
 Burmester® surround sound system .... 312
- Calls** ..... 273  
 Accepting ..... 273  
 Activating functions during a call ..... 273  
 Calls with several participants ..... 274  
 Declining ..... 273  
 Ending a call ..... 273  
 Incoming call during an existing call .... 274  
 Making ..... 273
- Camera**  
 see 360° Camera  
 see Rear view camera
- Car key**  
 see SmartKey
- Car wash**  
 see Care
- Car wash (care)** ..... 321
- Care** ..... 329  
 Car wash ..... 321  
 Carpet ..... 329  
 Display ..... 329  
 EASY-PACK trunk box ..... 329  
 Exterior lighting ..... 327  
 Folding draft stop ..... 327  
 Matt finish ..... 324

- Paintwork ..... 324  
 Plastic trim ..... 329  
 Power washer ..... 322  
 Real wood/trim elements ..... 329  
 Rear view camera/360° Camera ..... 327  
 Roof lining ..... 329  
 Seat belts ..... 329  
 Seat cover ..... 329  
 Sensors ..... 327  
 Soft top ..... 325  
 Tailpipes ..... 327  
 Washing by hand ..... 322  
 Wheels/rims ..... 327  
 Wind deflector ..... 325  
 Wind screen ..... 326  
 Windows ..... 327  
 Wiper blades ..... 327
- Carpet (Care)** ..... 329  
**Change of address** ..... 21  
**Change of ownership** ..... 21  
**Changing a wheel**  
 Lowering the vehicle ..... 381  
 Mounting a new wheel ..... 380  
 Preparation ..... 377
- Raising the vehicle ..... 378  
 Removing a wheel ..... 380  
 Removing/installing hub caps ..... 377  
**Changing hub caps** ..... 377  
**Channel list**  
 Calling up ..... 306  
**Character entry**  
 Function/notes ..... 229  
 On the touchpad ..... 230  
 Using the controller ..... 230  
**Charging**  
 Battery (vehicle) ..... 340  
 Mobile phone (wireless) ..... 108  
**Chassis level (AIR BODY CONTROL)**  
 Setting ..... 173  
**Child safety lock**  
 Rear side windows ..... 55  
 Setting ..... 236  
**Child seat**  
 Front passenger seat (notes) ..... 54  
 Front passenger seat (rearward-facing/forward-facing) ..... 54  
 LATCH-type (ISOFIX) (installing) ..... 52
- LATCH-type (ISOFIX) (notes) ..... 50  
 Notes ..... 47  
 Top Tether ..... 53  
**Child seat safety feature** ..... 50  
**Children**  
 Child seat safety feature ..... 50  
 Restraint systems ..... 47  
**Chock**  
 Storage location ..... 376  
**Chock**  
 see Wheel chock  
**Cigarette lighter**  
 Front center console ..... 107  
**Cleaning**  
 see Care  
**Climate control** ..... 124  
 3-zone automatic climate control  
 panel ..... 124  
 Activating/deactivating ..... 125  
 Activating/deactivating the A/C  
 function (control panel) ..... 125  
 Activating/deactivating the A/C  
 function (multimedia system) ..... 125

- Activating/deactivating the synchronization function (control panel) ..... 126
- Activating/deactivating the synchronization function (multimedia system) ..... 126
- Adjusting the climate style settings ..... 126
- Air distribution settings ..... 126
- Air-recirculation mode ..... 127
- Automatic control ..... 125
- Climate style function ..... 126
- Defrosting the windows ..... 126
- Defrosts the windshield ..... 124
- Dual-zone automatic climate control panel ..... 124
- Filling capacity for PAG oil ..... 393
- Front air vents ..... 128
- Glove box air vent ..... 129
- Inserting/removing the flacon (fragrance system) ..... 127
- Ionization ..... 127
- Rear air vents ..... 129
- Rear operating unit ..... 124
- Refrigerant ..... 392
- Refrigerant filling capacity ..... 393
- Residual heat ..... 127
- Sets the airflow ..... 124
- Setting the air distribution ..... 124
- Setting the fragrance system ..... 127
- Setting the temperature ..... 124
- Switching the rear window heater on/off ..... 124
- Ventilating the vehicle (convenience opening) ..... 73
- Climate style**
  - Function ..... 126
  - Setting ..... 126
- Cockpit** ..... 6
  - Overview ..... 6
- COMAND**
  - see Multimedia system
- COMAND Touch**
  - Managing devices ..... 236
- Combination switch**
  - see Turn signals
- Compass** ..... 268
- Computer**
  - On-board computer ..... 200
- Connection status**
  - Displaying ..... 288
- Overview ..... 288
- Contacts** ..... 274
  - Calling up ..... 275
  - Deleting ..... 276
  - Downloading (from mobile phone) ..... 274
  - Importing ..... 276
  - Information ..... 274
  - Making a call ..... 276
  - Name format ..... 275
  - Options ..... 276
  - Storing ..... 276
- Controller**
  - Operating ..... 224
- Convenience closing feature** ..... 74
- Convenience opening** ..... 73
- Coolant (engine)**
  - Checking level ..... 319
  - Filling capacity ..... 391
  - Notes ..... 391
- Cooling**
  - see Climate control
- Copyright**
  - Licenses ..... 29









Trademarks .....	30
<b>Cornering light function</b> .....	113
<b>Cross Traffic Alert</b> .....	189
<b>Crosswind Assist</b>	
Function/notes .....	155
<b>Cruise control</b> .....	160
Activating .....	160
Calling up a speed .....	160
Deactivating .....	160
Function .....	160
Lever .....	160
Prerequisites .....	160
Selecting .....	160
Setting a speed .....	160
Storing a speed .....	160
System limitations .....	160
<b>Cup holder</b>	
Rear bench seat .....	106
<b>Cup holder in the center console</b>	
Installing/removing (automatic transmission) .....	105
<b>Customer Assistance Center (CAC)</b> .....	25
<b>Customer Relations Department</b> .....	25























## D

<b>Dashboard</b>	
see Cockpit	
<b>Dashboard lighting</b>	
see Instrument lighting	
<b>Data acquisition</b>	
Vehicle .....	26
<b>Data import/export</b>	
Function/notes .....	237
Importing/exporting .....	237
PIN protection for data export .....	238
<b>Date</b>	
Setting the time and date automatically .....	232
<b>Daytime running lights</b> .....	115
Activating/deactivating .....	115
<b>Daytime running lights mode</b>	
see Daytime running lights	
<b>Deactivating the alarm (ATA)</b> .....	84
<b>Declaration of conformity</b>	
Wireless vehicle components .....	23
<b>Definitions (tires and loading)</b> .....	370

























## Designs













Menu (on-board computer) .....	210
<b>Destination</b> .....	259
Editing intermediate destinations .....	250
Editing the previous destinations .....	259
External .....	260
Saving (current vehicle position) .....	259
Saving as global favorite .....	259
Storing a map position .....	259
Using intelligent destination suggestions .....	260
<b>Destination entry</b> .....	246, 248
Enter geo-coordinates .....	250
Entering a POI or address .....	246
Entering an intermediate destination ...	249
Selecting a contact .....	250
Selecting a POI .....	248
Selecting from the map .....	251
Selecting previous destinations .....	248
<b>Detecting inattentiveness</b>	
see ATTENTION ASSIST	
<b>Diagnostics connection</b> .....	24
<b>Digital Operator's Manual</b> .....	18
<b>Digital speedometer</b> .....	204

- DIRECT SELECT lever** ..... 139
- Engaging drive position ..... 141
  - Engaging park position automatically .. 140
  - Engaging reverse gear ..... 140
  - Function ..... 139
  - Selecting park position ..... 140
  - Shifting to neutral ..... 140
- Display**
- Care ..... 329
- Display (multimedia system)**
- Notes ..... 223
  - Settings ..... 231
- Display (on-board computer)**
- Displays in the multifunction display ... 202
- Display content**
- (Additional value range) ..... 202
- Display message** ..... 395
- Calling up (on-board computer) ..... 395
  - Notes ..... 395
- Display messages**
-  ..... 424
  -  ..... 438
  -  ..... 437
-  ..... 438
  -  ..... 420
  - Active Blind Spot Assist Currently Unavailable See Operator's Manual ..... 417
  - Active Blind Spot Assist Inoperative ..... 417
  - Active Blind Spot Asst. Not Available When Towing a Trailer See Operator's Manual ..... 417
  - Active Brake Assist Functions Currently Limited See Operator's Manual ..... 408
  - Active Brake Assist Functions Limited See Operator's Manual ..... 408
  - Active Distance Assist Currently Unavailable See Operator's Manual ..... 419
  - Active Distance Assist Inoperative ..... 419
  - Active Distance Assist Now Available ... 419
  -  Active Headlamps Inoperative ..... 441
  - Active Hood Malfunction See Operator's Manual ..... 437
  - Active Lane Keeping Assist Camera View Restricted See Operator's Manual ..... 416
  - Active Lane Keeping Assist Currently Unavailable See Operator's Manual ..... 415
  - Active Lane Keeping Assist Inoperative ..... 415
  - Active Parking Assist and PARKTRONIC Inoperative See Operator's Manual ..... 418
  -  Active Steering Assist Currently Unavailable See Operator's Manual ..... 419
  -  Active Steering Assist Inoperative ..... 420
  - Adaptive Highbeam Assist Camera View Restricted See Operator's Manual ..... 443
  - Adaptive Highbeam Assist Currently Unavailable See Operator's Manual ... 443

- Adaptive Highbeam Assist Inoperative ..... 442
- Air Conditioning Malfunction See Operator's Manual ..... 434
- Apply Brake to Shift from 'P' ..... 432
-  ATTENTION ASSIST Inoperative ... 413
-  ATTENTION ASSIST: Take a Break! ..... 413
-  Auto Lamp Function Inoperative ..... 442
- Auxiliary Battery Malfunction ..... 434
- Blind Spot Assist Currently Unavailable See Operator's Manual ..... 416
- Blind Spot Assist Inoperative ..... 417
- Blind Spot Assist Not Available When Towing a Trailer See Operator's Manual ..... 417
-  BRAKE Check Brake Fluid Level ..... 405
- Check Coolant Level See Operator's Manual ..... 421
-  Check Engine Oil At Next Refueling ..... 424
-  Check Left Low Beam (Example) ..... 441
- Check Tire Pressure Soon ..... 425
-  Check Tires ..... 427
-  Check Washer Fluid ..... 439
-  Convertible Top Lowering ..... 440
-  Convertible Top Operation Possible to 35 mph ..... 440
-  Coolant Too Hot Stop Vehicle Turn Engine Off ..... 421
- Cruise Control Canceled ..... 420
- Cruise Control Inoperative ..... 420
-  Currently Unavailable See Operator's Manual ..... 397
-  Currently Unavailable See Operator's Manual ..... 398
-  Don't Forget Your Key ..... 431
- Driver's Door Open & Transmission Not in P Risk of Vehicle Rolling Away .. 432
-  Example: Front Left Seat Backrest Not Locked ..... 435
-  Example: Left Side Curtain Airbag Malfunction Service Required ..... 407
-  Front Left Malfunction Service Required (Example) ..... 410
- Front Passenger Airbag Disabled See Operator's Manual ..... 411
- Front Passenger Airbag Enabled See Operator's Manual ..... 412
-  Fuel Level Low ..... 424
-  Gas Cap Loose ..... 424
-  Inoperative See Operator's Manual ..... 396
-  Inoperative See Operator's Manual ..... 399
-  EBD Inoperative See Operator's Manual ..... 400



-  Inoperative ..... 405
-  Key Not Detected (white display message) ..... 431
-  Key Not Detected (red display message) ..... 431
-  Left Side Curtain Airbag Malfunction Service Required (example) .. 410  
Let fresh air into the vehicle interior.  
Air Conditioning Malf. Visit Workshop ..... 436
-  Lowering ..... 413
- Malfunction Drive at Max. 50 mph ..... 415
-  Malfunction See Operator's Manual ..... 442
-  Malfunction Service Required .... 439
- N Permanently Active Risk of Rolling Away ..... 433
-  Obtain a New Key ..... 430
-  Off ..... 419
- Only Shift to 'P' when Vehicle is Stationary ..... 433
-  Open/Close Convertible Top Completely ..... 440
-  Parking Brake See Operator's Manual ..... 402
-  Place the Key in the Marked Space See Operator's Manual ..... 432
-  Please Correct Tire Pressure ..... 426
-  Please Release Parking Brake ..... 401
- PRE-SAFE Inoperative See Operator's Manual ..... 408
- Radar Sensors Dirty See Operator's Manual ..... 406, 407
-  Rear Left Backrest Not Latched (Example) ..... 438
-  Replace Key Battery ..... 430
- Reversing Not Possible Service Required ..... 434
-  See Operator's Manual ..... 422
- Service Required Do Not Shift Gears Visit Dealer ..... 433
-  SRS Malfunction Service Required ..... 409
-  Start Engine See Operator's Manual ..... 422
-  Start Engine See Operator's Manual ..... 439
-  Steering Malfunction Drive Carefully Service Required ..... 435
-  Steering Malfunction Increased Physical Effort See Operator's Manual ..... 437
-  Steering Malfunction Stop Immediately See Operator's Manual ... 436
- Stop Vehicle Leave Engine Running Wait Transmission Cooling ..... 434
-  Stop Vehicle Leave Engine Running ..... 423

-  Stop Vehicle See Operator's Manual ..... 423  
 Stop Vehicle Vehicle Too Low ..... 414  
 Switch Off Lights ..... 442  
 Switch On Headlamps ..... 442  
 Tire Press. Monitor Currently Unavailable ..... 428  
 Tire Press. Monitor Inoperative ..... 429  
 Tire Pressure Monitor Inoperative No Wheel Sensors ..... 429  
 Tires Overheated ..... 429  
 Tires Overheated Decrease Speed ..... 430  
 To Deselect P or N, Depress Brake and Start Engine ..... 432  
 To Engage Transmiss. Position R First Depress the Brake ..... 435  
 Traffic Sign Assist Camera View Restricted See Operator's Manual ..... 418  
 Traffic Sign Assist Currently Unavailable See Operator's Manual ..... 418  
 Traffic Sign Assist Inoperative ..... 418  
 Transmission Malfunction Stop ..... 434  
 Trunk Partition Open ..... 441  
 Turn On the Ignition to Release the Parking Brake ..... 401  
 Vehicle Operational Switch the Ignition Off Before Exiting ..... 433  
 Vehicle Rising Please Wait ..... 414  
 Vehicle Rising ..... 413  
 Warning Tire Malfunction ..... 428  
 Wheel Sensor(s) Missing ..... 429  
 While stationary, apply the brakes before operating the soft top. .... 440  
**Display on the windshield**  
   see Head-up Display  
**Distance control**  
   see Active Distance Assist DISTRONIC  
**Distance recorder**  
   see Trip distance  
**DISTRONIC**  
   see Active Distance Assist DISTRONIC  
**Door**  
   Locking (mechanical key) ..... 65  
   Opening (from inside) ..... 62  
   Unlocking (from inside) ..... 62  
   Unlocking (mechanical key) ..... 65  
**Door control panel** ..... 14  
**DOT, Tire Identification Number (TIN)** ... 366  
**Drinking and driving** ..... 134  
**Drive Away Assist** ..... 188  
**Drive position**  
   Selecting ..... 141  
**Drive program display** ..... 138  
**Drive programs**  
   see DYNAMIC SELECT  
**Driving lights**  
   see Automatic driving lights  
**Driving safety system** ..... 153  
   ABS (Anti-lock Brake System) ..... 154  
   Active Brake Assist ..... 156  
   BAS (Brake Assist System) ..... 154

- EBD (Electronic Brake force Distribution) ..... 155
- ESP® (Electronic Stability Program)
  - Crosswind Assist ..... 155
  - Overview ..... 154
  - Radar sensors ..... 153
  - Responsibility ..... 153
  - STEER CONTROL ..... 155
- Driving system**
  - see 360° Camera
  - see Active Blind Spot Assist
  - see Active Distance Assist DISTRONIC
  - see Active Lane Keeping Assist
  - see Active Parking Assist
  - see Active Speed Limit Assist
  - see Active Steering Assist
  - see AIR BODY CONTROL
  - see ATTENTION ASSIST
  - see Blind Spot Assist
  - see Cruise control
  - see Driving safety system
  - see HOLD function
  - see Parking Assist PARKTRONIC
  - see Rear view camera
  - see Traffic Sign Assist
- Driving tips**
  - Drinking and driving ..... 134
  - General driving tips ..... 134
  - Notes on breaking-in a new vehicle ..... 134
- Drowsiness detection**
  - see ATTENTION ASSIST
- Drowsiness warning**
  - see ATTENTION ASSIST
- DYNAMIC SELECT** ..... 138
  - Configuring drive program I ..... 139
  - Displaying engine data ..... 139
  - Displaying vehicle data ..... 139
  - Drive program display ..... 138
  - Drive programs ..... 138
  - Function ..... 138
  - Operating (DYNAMIC SELECT switch) ..... 138
  - Selecting the drive program ..... 138
- E**
- E10** ..... 388
- Easy entry feature**
  - Function/notes ..... 97
  - Setting ..... 98
- Easy exit feature**
  - Function/notes ..... 97
  - Setting ..... 98
- EBD (Electronic Brake force Distribution)**
  - Function/notes ..... 155
- ECO display**
  - Function ..... 137
  - Resetting ..... 206
- ECO start/stop function** ..... 136, 137
  - Automatic engine start ..... 136
  - Automatic engine stop ..... 136
  - Method of operation ..... 136
  - Switching off/on ..... 137
- Electric parking brake** ..... 150, 151, 152
  - Applying automatically ..... 150
  - Applying or releasing manually ..... 152
  - Emergency braking ..... 152
  - Releasing automatically ..... 151
- Electrical fuses**
  - Before replacing a fuse ..... 348
- Electrical fuses**
  - see Fuses

- Electronics** ..... 383
- Emergency**  
 Overview of the help functions ..... 16  
 Safety vest ..... 332
- Emergency braking** ..... 152
- Emergency call system**  
 Mercedes-Benz mbrace® (USA) ..... 283
- Emergency engine start** ..... 348
- Emergency operation mode**  
 Starting the vehicle ..... 132
- Emergency release**  
 Trunk lid (from inside) ..... 70
- Emergency Tensioning Devices**  
 Activation ..... 32
- ENERGIZING comfort**  
 Overview of programs ..... 243  
 Starting the program ..... 244
- Energy consumption**  
 SmartKey ..... 58
- Engine**  
 ECO start/stop function ..... 136  
 Engine number ..... 385
- Jump-starting ..... 340  
 Starting (emergency operation mode) ..... 132  
 Starting (Remote Online) ..... 133  
 Starting (start/stop button) ..... 132  
 Switching off (start/stop button) ..... 145
- Engine data**  
 Displaying ..... 139
- Engine hood**  
 Opening/closing ..... 315
- Engine number** ..... 385
- Engine oil** ..... 318  
 Additives ..... 389  
 Capacity ..... 390  
 Checking the oil level using the oil dipstick ..... 318  
 MB-Freigabe or MB-Approval ..... 390  
 Quality ..... 390  
 Topping up ..... 318
- ESP®**  
 Crosswind Assist ..... 155
- ESP® (Electronic Stability Program)**  
 Activating/deactivating ..... 155
- Exterior lighting**  
 Care ..... 327
- Exterior lighting**  
 see Lights
- External device**  
 Locking ..... 236
- Eyeglasses compartment** ..... 101
- F**
- Fatigue warning**  
 see ATTENTION ASSIST
- Fault message**  
 see Display message
- Favorites**  
 Adding ..... 227  
 Calling up ..... 227  
 Deleting ..... 228  
 Moving ..... 228  
 Overview ..... 227  
 Renaming ..... 228
- Flacon**  
 Inserting/removing ..... 127

- Flat tire** ..... 332  
 Changing a wheel ..... 377  
 MOExtended tires ..... 333  
 Notes ..... 332  
 TIREFIT kit ..... 334
- Floor mats** ..... 110
- Folding draft stop**  
 Care ..... 327
- Folding wind screen**  
 Installing ..... 80  
 Removing ..... 80
- Fragrance**  
 see Fragrance system
- Fragrance system** ..... 127  
 Inserting/removing the flacon ..... 127
- Free software** ..... 29
- Frequencies**  
 Two-way radio ..... 384
- Frequency band**  
 Selecting (on-board computer) ..... 207
- Front air bag** ..... 38
- Front passenger front air bag shutoff**  
 see Automatic front passenger front  
 air bag shutoff
- Front passenger seat**  
 Adjusting from the driver's seat ..... 88
- Fuel** ..... 389  
 Additives ..... 389  
 E10 ..... 388  
 Gasoline ..... 388  
 Quality (gasoline) ..... 388  
 Refueling ..... 143  
 Reserve fuel level ..... 389  
 Sulfur content ..... 388  
 Tank capacity ..... 389
- Fuel consumption**  
 On-board computer ..... 204
- Function seat**  
 see Door control panel
- Fuse insert**  
 see Fuses
- Fuses** ..... 348  
 Assignment diagram ..... 348  
 Dashboard fuse box ..... 350  
 Fuse box in the engine compartment .. 349
- Fuse box in the front-passenger foot-  
 well ..... 350  
 Fuse box in the trunk ..... 351  
 Notes ..... 348
- G**
- Garage door opener**  
 Clearing the memory ..... 149  
 Opening/closing the garage door ..... 148  
 Programming buttons ..... 146  
 Radio equipment approval numbers .... 149  
 Resolving problems ..... 148  
 Synchronizing the rolling code ..... 147
- Gas station search**  
 Starting an automatic gas station  
 search ..... 249  
 Switching the automatic gas station  
 search on/off ..... 254
- Gasoline** ..... 388
- Gearshift paddles**  
 see Steering wheel paddle shifters
- Gearshift recommendation** ..... 141
- Genuine parts** ..... 19

<b>Glide mode</b> .....	142
<b>Glove box</b>	
Air vent .....	129
Locking/unlocking .....	101

## H

<b>Handbrake</b>	
see Electric parking brake	
<b>Handling characteristics (unusual)</b> .....	352
<b>HANDS-FREE ACCESS</b> .....	69
<b>Hazard warning lights</b> .....	113
<b>Head air bag</b> .....	38
<b>Head level heating (AIRSCARF)</b> .....	94
<b>Head restraint</b> .....	89
Front (adjusting manually) .....	89
Rear passenger compartment (remove/installing) .....	91
<b>Head-up Display</b> .....	209
Adjusting brightness (on-board com- puter) .....	209
Adjusting display elements (on-board computer) .....	209
Function .....	210

Menu (on-board computer) .....	209
Setting the position (on-board com- puter) .....	209
Switching on/off .....	211
Using the memory function .....	98

## Heating

    see Climate control

<b>High-beam flasher</b> .....	112
--------------------------------	-----

## High-beam headlamps

Activating/deactivating .....	112
Adaptive Highbeam Assist .....	114

<b>Hill start assist</b> .....	170
--------------------------------	-----

<b>HOLD function</b> .....	170
----------------------------	-----

Activating/deactivating .....	170
Function/notes .....	170

## Hood

Function (active hood) .....	315
Resetting (active hood) .....	315

<b>Hooking the luggage net</b> .....	104
--------------------------------------	-----

## Hotspot

Setting up (Wi-Fi) .....	235
--------------------------	-----

## I

### Identification plate

Engine .....	385
Refrigerant .....	392
Vehicle .....	385

### Ignition

Switching on (Start/Stop button) .....	131
--	-----

### Ignition key

    see SmartKey

<b>Immobilizer</b> .....	83
--------------------------	----

### Indicator lamp

    see Warning/indicator lamps

### Individual drive program

Configuring .....	139
Selecting .....	138

### Instrument cluster

    see Instrument Display  
    see Warning/indicator lamps

<b>Instrument Display</b> .....	199
---------------------------------	-----

Adjusting the lighting .....	203
Function/notes .....	199
Overview .....	199
Overview (standard) .....	8

- Overview (Widescreen) ..... 8
  - Warning/indicator lamps ..... 443
  - Instrument lighting** ..... 203
  - Intelligent Light System**
    - Cornering light function ..... 113
  - Interior lighting** ..... 115
    - Ambient lighting ..... 116
    - Setting ..... 115
    - Switch-off delay time ..... 116
  - Interior lighting**
    - see Interior lighting
    - see Lighting
    - see Lights
  - Intermediate destination**
    - Calculating a route with intermediate destinations ..... 250
    - Editing ..... 250
    - Entering ..... 249
    - Starting an automatic gas station search ..... 249
    - Starting the automatic service station search ..... 254
  - Internet**
    - Deleting a bookmark ..... 290
    - Deleting browser data ..... 290
    - Managing bookmarks ..... 290
  - Internet connection**
    - Canceling permission ..... 287
    - Connection status ..... 288
    - Displaying the connection status ..... 288
    - Editing access data ..... 287
    - Establishing ..... 288
    - Mobile phone details ..... 288
    - Restrictions ..... 285
    - Setting access data ..... 286
    - Setting up (Bluetooth®) ..... 286
    - Switching Bluetooth® profile (DUN/PAN) ..... 287
    - Via Bluetooth® ..... 286
    - Via Wi-Fi ..... 285
  - Internet radio**
    - Calling up ..... 291
    - Deleting stations ..... 291
    - Logging in ..... 292
    - Logging out ..... 292
    - Overview ..... 291
    - Saving stations ..... 291
    - Selecting and connecting to a station ..... 291
  - Selecting stream ..... 292
  - Setting options ..... 292
  - Terms of use ..... 292
  - Ionization** ..... 127
  - iPhone®**
    - see Apple CarPlay™
- J**
- Jack**
    - Storage location ..... 376
  - Jump-start connection** ..... 340
  - Jump-starting**
    - see Jump-start connection
- K**
- KEYLESS-GO**
    - Locking the vehicle ..... 62
    - Problem ..... 63
    - Unlocking setting ..... 58
    - Unlocking the vehicle ..... 62
  - Kickdown** ..... 142
    - Using ..... 142
  - Knee air bag** ..... 38

- L**
- Labeling (tires)**  
see Tire labeling
- Laden** ..... 102  
Stowage space under the trunk floor ... 104  
Tie-down eyes ..... 102
- Lamp**  
see Interior lighting
- Lamp (Instrument Display)**  
see Warning/indicator lamps
- Lane Keeping Assist**  
see Active Lane Keeping Assist
- Language**  
Notes ..... 237  
Setting ..... 237
- LATCH-type (ISOFIX) child seat attachment**  
Installing ..... 52  
Notes ..... 50
- Level control system**  
see AIR BODY CONTROL
- Light switch**  
Overview ..... 111
- Lighting** ..... 115
- Lighting**  
see Lights
- Lights** ..... 111, 115  
Adaptive Highbeam Assist ..... 114  
Adjusting the instrument lighting ..... 203  
Automatic driving lights ..... 112  
Combination switch ..... 112  
Cornering light function ..... 113  
Hazard warning lights ..... 113  
High-beam flasher ..... 112  
High-beam headlamps ..... 112  
Light switch ..... 111  
Low beam ..... 111  
Parking lights ..... 111  
Rear fog light ..... 112  
Responsibility for lighting systems ..... 111  
Setting the surround lighting ..... 115  
Standing lights ..... 111  
Turn signals ..... 112
- Limited Warranty**  
Vehicle ..... 26
- Live Traffic Information**  
Displaying subscription information ..... 261
- Displaying the traffic map ..... 261  
Displaying traffic incidents ..... 262  
Extending a subscription ..... 261  
Issuing hazard alerts ..... 263
- Load index (tires)** ..... 368
- Load-bearing capacity (tires)** ..... 368
- Loading**  
Bag hook ..... 103  
Definitions ..... 370  
Notes ..... 99
- Loading guidelines** ..... 99
- Loading information table** ..... 360
- Loads**  
Securing ..... 99
- Locator lighting**  
Activating/deactivating ..... 115
- Locking/unlocking** ..... 62  
KEYLESS-GO ..... 62
- Low beam**  
Switching on/off ..... 111
- Lubricant additives**  
see Additives



- Luggage**
    - Luggage net ..... 104
    - Securing ..... 99
  - Lumbar support**
    - see Lumbar support (4-way)
  - Lumbar support (4-way)** ..... 89
- M**
- MAGIC VISION CONTROL**
    - Windshield wipers ..... 119
  - Maintenance**
    - Menu (on-board computer) ..... 203
    - Vehicle ..... 21
  - Maintenance**
    - see ASSYST PLUS
  - Making a call via the overhead control panel**
    - Mercedes-Benz mbrace® (USA only) ... 282
  - Malfunction**
    - Restraint system ..... 32
  - Map** ..... 261, 263, 264
    - Avoiding an area ..... 266
    - Avoiding an area (overview) ..... 266
    - Changing an area ..... 267
    - Deleting an area ..... 267
    - Displaying the compass ..... 268
    - Displaying the map version ..... 266
    - Displaying the next intersecting street ..... 266
    - Displaying the satellite map ..... 268
    - Displaying the traffic map ..... 261
    - Displaying traffic signs ..... 266
    - Displaying weather information ..... 268
    - Map data ..... 267
    - Moving ..... 264
    - Overview ..... 263
    - Selecting POI symbols ..... 265
    - Selecting text information ..... 265
    - Selecting the map orientation ..... 265
    - Setting the map scale ..... 264
    - Setting the map scale automatically ... 268
    - Switching highway information on/off ..... 265
    - Updating ..... 267
  - Map and compass**
    - Overview ..... 263
  - Massage program**
    - Selecting the front seats ..... 91
  - Massage programs**
    - Overview ..... 91
  - Massage settings**
    - Resetting ..... 92
  - Matt finish (cleaning instructions)** ..... 324
  - Maximum load rating** ..... 367
  - Maximum permissible load**
    - Calculation example ..... 362
    - Determining ..... 361
  - Maximum tire pressure** ..... 367
  - Mechanical key**
    - Inserting/removing ..... 59
    - Locking a door ..... 65
    - Unlocking a door ..... 65
  - Media**
    - Menu (on-board computer) ..... 208
    - Searching ..... 299
  - Media display**
    - Notes ..... 223
  - Media Interface**
    - Activating ..... 300
    - Information ..... 299
    - Overview ..... 301

- Media mode**
  - Activating ..... 294
- Media playback**
  - Operating (on-board computer) ..... 208
- Media search**
  - Starting ..... 299
- Media source**
  - Dialling (on-board computer) ..... 208
- Memory function**
  - Head-up display – Calling up saved settings ..... 98
  - Head-up Display – Saving settings ..... 98
  - Operating ..... 98
  - Outside mirror – Calling up saved settings ..... 98
  - Outside mirror – Saving settings ..... 98
  - Seat – Calling up saved settings ..... 98
  - Seat – Saving settings ..... 98
  - Steering wheel – Calling up saved settings ..... 98
  - Steering wheel – Saving settings ..... 98
- Menu (on-board computer)**
  - Assistance graphic ..... 204
  - Designs ..... 210
- Maintenance ..... 203
- Media ..... 208
- Navigation ..... 206
- Overview ..... 200
- Radio ..... 207
- Telephone ..... 208
- Trip ..... 204
- Mercedes-Benz Apps**
  - Calling up ..... 288
  - Using voice control ..... 288
- Mercedes-Benz Center**
  - see Qualified specialist workshop
- Mercedes-Benz mbrace® (USA only)**
  - Making a call via the overhead control panel ..... 282
- Mercedes-Benz mbrace® (USA)**
  - Emergency call system ..... 283
  - MB Info call ..... 284
  - Roadside Assistance call ..... 284
  - Transferred data ..... 284
- Message (multifunction display)**
  - see Display message
- Message memory** ..... 395
- Messages**
  - see Text messages
- Mirrors**
  - see Outside mirrors
- Mobile phone**
  - Canceling permission for Internet connection ..... 287
  - Wireless charging ..... 109
- Mobile phone**
  - see Android Auto
  - see Apple CarPlay™
  - see Telephone
- Mobile phone voice recognition**
  - Starting ..... 273
  - Stopping ..... 273
- Model series** ..... 385
- MOExtended tires** ..... 333
- Multifunction display (on-board computer)** ..... 202
- Multifunction steering wheel**
  - Overview of buttons ..... 200
- Multifunction steering wheel**
  - see Steering wheel

<b>Multimedia system</b> .....	223, 231
Activating/deactivating standby mode .....	153
Adjusting the volume .....	229
Calling up lists and menus .....	227
Central control elements .....	223
Configuring display settings .....	231
ENERGIZING comfort program overview .....	243
Main functions .....	226
Overview .....	223
Restoring the factory settings .....	242
Starting the ENERGIZING comfort program .....	244
Switching the sound on/off .....	228

## N

### Navigation

Calling up the Digital Operator's Manual .....	269
Menu (on-board computer) .....	206
Showing/hiding the menu .....	245
Switching on .....	245
Updating the map data .....	267

Voice commands (Voice Control System) .....	216
---	-----

### Navigation

see Destination	
see Destination entry	
see Map	
see Route	
see Route guidance	
see Traffic information	

### Navigation announcements

Activating/deactivating .....	257
Adjusting the volume .....	257
Repeating .....	258
Switching audio fadeout on/off .....	257
Switching on/off during a phone call ..	257

### Navigation messages

On-board computer .....	206
-------------------------	-----

### Near Field Communication (NFC) .....

Connecting the mobile phone to the multimedia system .....	272
Information .....	272
Switching Bluetooth® audio equipment .....	304
Switching mobile phones .....	272

### Neutral

Selecting .....	140
-----------------	-----

### NFC

see Near Field Communication (NFC)	
------------------------------------	--

### Notes on breaking-in a new vehicle .....

134

## O

### Occupant safety

Pets in the vehicle .....	56
---------------------------	----

### Occupant safety

see Air bag	
see Automatic front-passenger front air bag deactivation system	
see PRE-SAFE® (anticipatory occupant protection)	
see PRE-SAFE® PLUS (anticipatory occupant protection plus)	
see Restraint system	
see Seat belts	

### Odometer

see Total distance	
--------------------	--

### Oil

see Engine oil	
----------------	--

- On-board computer** ..... 209
- Assistance graphic menu ..... 204
  - Displaying the service due date ..... 314
  - Media menu ..... 208
  - Menu designs ..... 210
  - Menus ..... 200
  - Multifunction display ..... 202
  - Navigation system menu ..... 206
  - Operating ..... 200
  - Radio menu ..... 207
  - Service menu ..... 203
  - Telephone menu ..... 208
  - Trip menu ..... 204
- On-board diagnostics interface**  
see Diagnostics connection
- Open-source software** ..... 29
- Opening the trunk lid using your foot**  
HANDS-FREE ACCESS ..... 69
- Operating fluids**
- Additives (fuel) ..... 389
  - Brake fluid ..... 390
  - Coolant (engine) ..... 391
  - Engine oil ..... 389
  - Fuel (gasoline) ..... 388
- Notes ..... 387
  - Refrigerant (air conditioning system) ... 392
  - Windshield washer fluid ..... 391
- Operating safety**
- 48 V on-board electrical system ..... 22
  - Declaration of conformity (wireless vehicle components) ..... 23
  - Information ..... 22
- Operating system**  
On-board computer ..... 200
- Operator's Manual**  
Vehicle equipment ..... 20
- Operator's Manual (digital)** ..... 18
- Outside mirrors** ..... 120, 121, 122
- Anti-glare mode (automatic) ..... 121
  - Automatic mirror folding function ..... 123
  - Folding in/out ..... 120
  - Parking position ..... 122
  - Setting ..... 120
  - Using the memory function ..... 98
- Overhead control panel**  
Overview ..... 12
- P**
- Paint code** ..... 385
- Paintwork (cleaning instructions)** ..... 324
- Panel heating**  
Setting ..... 94
- Panic alarm** ..... 58  
Activating/deactivating ..... 58
- Park position**  
Selecting ..... 140  
Selecting automatically ..... 140
- Parking** ..... 152
- Parking**  
see Electric parking brake
- Parking aid**  
see Parking Assist PARKTRONIC
- Parking Assist**  
Maneuvering assistance ..... 189
- Parking Assist PARKTRONIC** ..... 175
- Adjusting warning tones ..... 178
  - Function ..... 175
  - Side impact protection ..... 176
  - Switching off ..... 177

- Switching on ..... 177
- System limitations ..... 175
- Parking assistance systems**  
see Active Parking Assist
- Parking brake**  
see Electric parking brake
- Parking lights** ..... 111
- Parking position**  
Outside mirrors ..... 122  
Storing the position of the passenger  
outside mirror using reverse gear ..... 122
- PASSENGER AIR BAG status display**  
see Automatic front passenger front  
air bag shutoff
- Payload**  
Calculation example ..... 362  
Determining the maximum ..... 361
- Pedestrian protection**  
see Active hood (pedestrian protection)
- Perfume**  
see Fragrance system
- Perfume atomizer**  
Setting ..... 127
- Perfume vial**  
see Fragrance system
- Period out of use**  
Activating/deactivating standby  
mode ..... 153
- Permitted towing methods** ..... 343
- Personalization**  
see User profile
- Pets in the vehicle** ..... 56
- Phone book**  
see Contacts
- Picture formats**  
see Video mode
- Picture settings**  
see Video mode
- PIN protection**  
Activating/deactivating ..... 238
- PIN protection for data export** ..... 238
- Plastic trim (Care)** ..... 329
- Playback options**  
Selecting ..... 296
- POI symbols**  
Custom ..... 265
- Power supply**  
Switching on (Start/Stop button) ..... 131
- Power washer (care)** ..... 322
- PRE-SAFE® (anticipatory occupant protection)** ..... 46  
Function ..... 46  
PRE-SAFE® Sound ..... 46  
Reversing the measures ..... 46
- PRE-SAFE® PLUS (anticipatory occupant protection plus)** ..... 47  
Function ..... 47  
Reversing the measures ..... 46
- Preventative occupant protection system**  
see PRE-SAFE® (anticipatory occupant protection)
- Previous destinations**  
Selecting ..... 248
- Programs**  
see DYNAMIC SELECT

**Protecting the environment**

Notes ..... 19

**Q****QR code**

Rescue card ..... 26

**Qualified specialist workshop** ..... 25**R****Radar sensors** ..... 153**Radio**

Activating ..... 304

Activating/deactivating radio text ..... 307

Calling up the channel list ..... 306

Deleting stations ..... 306

Direct frequency entry ..... 306

Displaying information ..... 307

Displaying radio text ..... 307

Editing station presets ..... 306

Menu (on-board computer) ..... 207

Moving stations ..... 306

Overview ..... 305

Searching for stations ..... 306

Setting a station ..... 306

Setting the waveband ..... 306

Storing radio stations ..... 306

Switching HD Radio on/off ..... 306

Tagging music tracks ..... 307

Voice commands (Voice Control System) ..... 219

**Radio stations**

Selecting (on-board computer) ..... 207

**Range**

Displaying ..... 204

**Reading lamp**

see Interior lighting

**Real wood (Care)** ..... 329**Rear fog light** ..... 112**Rear seat**

see Seat

**Rear view camera** ..... 178

Assigning as a favorite (360° Camera) ..... 183

Function ..... 178

Opening the camera cover (360° Camera) ..... 183

**Rear view camera/ 360° Camera**

Care ..... 327

**Rear window heater** ..... 124**Rear-view mirror**

see Outside mirrors

**Refrigerant (air conditioning system)**

Notes ..... 392

**Refueling**

Refueling the vehicle ..... 143

**Remote Online**

Cooling or heating the vehicle interior ..... 133

Starting the vehicle ..... 133

**Reporting malfunctions relevant to safety** ..... 25**Rescue card** ..... 26**Reserve**

Fuel ..... 389

**Reset function (multimedia system)** ..... 242**Residual heat** ..... 127**Restoring (factory settings)**

see Reset function (multimedia system)

<b>Restraint system</b> .....	31
Children .....	47
Function in an accident .....	32
Functionality .....	32
Malfunction .....	32
Protection .....	31
Reduced protection .....	31
System self-test .....	32
Warning lamp .....	32
<b>Reverse gear</b>	
Selecting .....	140
<b>Rims (Care)</b> .....	327
<b>Roadside Assistance</b> .....	21
<b>Roadside Assistance call</b>	
Mercedes-Benz mbrace® (USA) .....	284
<b>Roll away protection</b>	
see HOLD function	
<b>Roll bar</b>	
Function .....	45
<b>Roof lining (care)</b> .....	329
<b>Roof load</b> .....	394
<b>Route</b> .....	252, 254
Calculating .....	252

Displaying destination information .....	253
External .....	260
Selecting a type .....	252
Selecting an alternative route .....	254
Selecting notifications .....	253
Selecting options .....	253
Starting the automatic service station search .....	254
Switching the automatic gas station search on/off .....	254
With intermediate destinations .....	250
<b>Route guidance</b> .....	255
Canceling .....	258
Changing direction .....	255
Continuing .....	258
Destination reached .....	256
From an off-road location .....	258
Lane recommendations .....	256
Notes .....	255
Off-road .....	259
To an off-road destination .....	258
<b>Run-flat characteristics</b>	
MOExtended tires .....	333

## S

**Safety systems**

  see Driving safety system

<b>Safety vest</b> .....	332
--------------------------	-----

<b>Satellite map</b> .....	268
----------------------------	-----

**Satellite radio**

Activating/deactivating Tune Start .....	311
Deleting a channel .....	310
Displaying EPG information .....	310
Displaying service information .....	311
Information .....	307
Information on smart favorites and Tune Start .....	311
Logging in .....	307
Moving a channel .....	310
Music and sport alerts function .....	310
Overview .....	309
Pause and playback function .....	311
Restrictions .....	307
Selecting a category .....	310
Selecting a channel .....	310
Setting music and sport alerts .....	310
Setting the parental control .....	310
Storing a channel .....	310

- Switching on ..... 308
- SD card**
  - Inserting/removing ..... 294
- Seat** ..... 101
  - 4-way lumbar support ..... 89
  - Adjusting (electrically) ..... 88
  - Adjusting (manually and electrically) ..... 86
  - Backrest (rear) folding forward ..... 101
  - Correct driver's seat position ..... 85
  - Folding back the backrest (rear passenger compartment) ..... 102
  - Folding the backrest forwards/back (with memory function) ..... 92
  - Massage program overview ..... 91
  - Panel heating ..... 94
  - Resetting the settings ..... 92
  - Selecting a massage program ..... 91
  - Setting options ..... 14
  - Switching AIRSCARF on/off ..... 94
  - Using the memory function ..... 98
- Seat**
  - see Head restraint
- Seat adjustment**
  - Configuring ..... 91
- Seat belt**
  - Releasing ..... 38
- Seat belt adjustment**
  - Activating/deactivating ..... 38
  - Function ..... 37
- Seat belt extender** ..... 36
- Seat belt warning**
  - see Seat belts
- Seat belts** ..... 33, 38
  - Activating/deactivating seat belt adjustment ..... 38
  - Care ..... 329
  - Fastening ..... 37
  - Protection ..... 33
  - Reduced protection ..... 34
  - Seat belt adjustment (function) ..... 37
  - Seat belt extender ..... 36
  - Warning lamp ..... 38
- Seat cover (Care)** ..... 329
- Seat heating**
  - Activating/deactivating ..... 92
- Seat ventilation**
  - Switching on/off ..... 94
- Selecting a gear**
  - see Shifting gears
- Selecting a POI**
  - see Destination entry
- Selector lever**
  - see DIRECT SELECT lever
- Sensors (Care)** ..... 327
- Service center**
  - see Qualified specialist workshop
- Service interval display**
  - see ASSYST PLUS
- Setting a speed**
  - see Cruise control
- Setting summer time** ..... 232
- Setting the date format** ..... 232
- Setting the distance unit** ..... 237
- Setting the map scale**
  - see Map
- Shifting gears** ..... 141
  - Gearshift recommendation ..... 141
  - Manual ..... 141



- Short messages**
  - see Text messages
- Side impact air bag** ..... 38
- Side impact protection** ..... 176
- Side windows** ..... 71
  - Child safety lock in the rear passenger compartment ..... 55
  - Closing ..... 71
  - Closing (all) ..... 71
  - Closing using the SmartKey ..... 74
  - Convenience closing feature ..... 73
  - Convenience opening ..... 73
  - Opening ..... 71
  - Opening (all) ..... 71
  - Opening with the SmartKey ..... 73
  - Problem ..... 75
- Size designation (tires)** ..... 368
- SmartKey** ..... 57
  - Battery ..... 59
  - Energy consumption ..... 58
  - Features ..... 57
  - Key ring attachment ..... 59
  - Mechanical key ..... 59
  - Overview ..... 57
- Panic alarm ..... 58
- Problem ..... 60
- Unlocking setting ..... 58
- Smartphone**
  - see Android Auto
  - see Apple CarPlay™
  - see Telephone
- Snow chains** ..... 353
- Socket (12 V)** ..... 107
  - Front center console ..... 107
  - Rear passenger compartment ..... 108
- Soft top**
  - Care ..... 325
  - Closing (soft-top switch) ..... 76
  - Closing using the SmartKey ..... 74
  - Opening (soft-top switch) ..... 76
  - Opening with the SmartKey ..... 73
  - Problem ..... 82
  - Relocking ..... 78
- Soft-top switch** ..... 76
- Software update**
  - Important system updates ..... 241
  - Information ..... 240
  - Performing ..... 241
- Sound**
  - PRE-SAFE® Sound ..... 46
  - Wheels and tires ..... 352
- Sound**
  - see Burmester® surround sound system
  - see Sound settings
- Sound settings** ..... 311
  - Adjusting the balance/fader ..... 312
  - Adjusting treble, mid-range and bass settings ..... 312
  - Automatic volume adjustment ..... 312
  - Calls up the sound menu ..... 312
  - Information ..... 311
- Speech dialog system**
  - see Voice Control System
- Speed index (tires)** ..... 368
- Speedometer**
  - Digital ..... 204
- Standby mode**
  - Activating/deactivating ..... 153
  - Function ..... 152
- Standing lights** ..... 111

- Start/Stop button**  
Starting the vehicle ..... 132  
Switching off the vehicle ..... 145  
Switching on the power supply or  
ignition ..... 131
- Start/stop function**  
see ECO start/stop function
- Starting the engine**  
see Vehicle
- Starting-off aid**  
see Hill start assist
- Station**  
Deleting ..... 306  
Direct frequency entry ..... 306  
Moving ..... 306  
Searching ..... 306  
Setting ..... 306  
Storing ..... 306
- Station presets**  
Editing ..... 306
- STEER CONTROL**  
Function/notes ..... 155
- Steering wheel** ..... 200  
Adjusting (electrically) ..... 96  
Adjusting (manually) ..... 95  
Buttons ..... 200  
Steering wheel heater ..... 97  
Using the memory function ..... 98
- Steering wheel heater**  
Switching on/off ..... 97
- Steering wheel paddle shifters** ..... 141
- Stowage areas**  
see Laden  
see Stowage compartment
- Stowage compartment** ..... 100  
Armrest ..... 100  
Center console ..... 100  
Door ..... 100  
Eyeglasses compartment ..... 101  
Glove box ..... 100
- Stowage compartments**  
see Laden  
see Stowage compartment
- Stowage space under the trunk floor** .... 104
- Sulfur content** ..... 388
- Sun visor**  
Operating ..... 123
- Surround View**  
see 360° Camera
- Suspension**  
Adjusting the chassis level (AIR  
BODY CONTROL) ..... 173
- Suspension**  
see AIR BODY CONTROL
- Switch-off delay time**  
Exterior ..... 115  
Interior ..... 116
- Switching the surround sound on/off**  
Burmester® surround sound system .... 313
- Synchronization function**  
Activating/deactivating (control  
panel) ..... 126  
Activating/deactivating (multimedia  
system) ..... 126
- System self-test**  
Automatic front passenger front air  
bag shutoff ..... 43

**System settings**

Language .....	237
Notes on language selection .....	237
Reset function (multimedia system) ....	242
Setting the distance unit .....	237
Software update .....	241

**System settings**

see Multimedia system

**T**

<b>Tailpipes (Care)</b> .....	327
-------------------------------	-----

**Tank capacity**

Fuel .....	389
Reserve (fuel) .....	389

**Technical data**

Information .....	383
Tire pressure monitoring system .....	359
Vehicle identification plate .....	385

<b>Telephone</b> .....	208, 269
------------------------	----------

Activating functions during a call .....	273
Call and ringtone volume .....	273
Calls with several participants .....	274
Connecting a mobile phone (Near Field Communication (NFC)) .....	272

Connecting a mobile phone (Pass-key) .....	271
--	-----

Connecting a mobile phone (Secure Simple Pairing) .....	271
---	-----

Disconnecting a mobile phone .....	272
Importing contacts .....	275

Incoming call during an existing call ....	274
Information .....	270

Menu (on-board computer) .....	208
Mobile phone voice recognition .....	273
Notes .....	270

Operating modes .....	270
Reception and transmission volume ....	273

Switching mobile phones .....	271
Switching mobile phones (Near Field Communication (NFC)) .....	272

Telephone menu overview .....	269
Telephone operation .....	273

Using Near Field Communication (NFC) .....	272
Voice commands (Voice Control System) .....	218

Wireless charging (mobile phone) .....	109
--	-----

**Telephone number**

Dialing (on-board computer) .....	208
-----------------------------------	-----

**Telephony operating modes**

Bluetooth® Telephony .....	270
----------------------------	-----

<b>Temperature</b> .....	124
--------------------------	-----

<b>Temperature grade</b> .....	365
--------------------------------	-----

<b>Text messages</b> .....	277
----------------------------	-----

calling a message sender .....	278
Changing folders .....	279

Composing .....	278
Configuring the displayed text messages .....	277

Deleting .....	279
Drafts .....	279

Notes .....	277
Options .....	279

Outbox .....	279
Read-aloud function .....	278

Reading .....	278
Replying .....	278

Sending .....	278
Voice commands (Voice Control System) .....	220

**Through-loading feature**

see Seat

<b>Tie-down eyes</b> .....	102
----------------------------	-----

- Time**  
Manual time setting ..... 232  
Setting summer time ..... 232  
Setting the time and date automatically ..... 232  
Setting the time zone ..... 232  
Setting the time/date format ..... 232
- TIN (Tire Identification Number)** ..... 366
- Tire and Loading Information placard** ... 360
- Tire characteristics** ..... 368
- Tire inflation compressor**  
see TIREFIT kit
- Tire information table** ..... 360
- Tire labeling** ..... 365  
Characteristics ..... 368  
DOT, Tire Identification Number (TIN) ..... 366  
Load index ..... 368  
Load-bearing capacity ..... 368  
Maximum tire load ..... 367  
Maximum tire pressure ..... 367  
Overview ..... 365  
Speed rating ..... 368  
Temperature grade ..... 365
- Tire Quality Grading ..... 365  
Tire size designation ..... 368  
Traction grade ..... 365  
Tread wear grade ..... 365
- Tire load (maximum)** ..... 367
- Tire pressure** ..... 356  
Checking (manually) ..... 356  
Checking (tire pressure monitoring system) ..... 358  
Maximum ..... 367  
Notes ..... 354  
Restarting the tire pressure loss warning system ..... 360  
Restarting the tire pressure monitoring system ..... 359  
Tire pressure loss warning system (function) ..... 359  
Tire pressure monitoring system (function) ..... 357  
Tire pressure table ..... 355  
TIREFIT kit ..... 334
- Tire pressure loss warning system**  
Function ..... 359  
Restarting ..... 360
- Tire pressure monitoring system**  
Checking the tire pressures ..... 358  
Checking the tire temperature ..... 358  
Function ..... 357  
Restarting ..... 359  
Technical data ..... 359
- Tire pressure table** ..... 355
- Tire Quality Grading** ..... 365
- Tire temperature**  
Checking (tire pressure monitoring system) ..... 358  
Tire pressure monitoring system (function) ..... 357
- Tire tread** ..... 352
- Tire-change tool kit**  
Overview ..... 376
- TIREFIT kit** ..... 334  
Storage location ..... 334  
Using ..... 334
- Tires**  
Changing hub caps ..... 377  
Characteristics ..... 368  
Checking ..... 352

- Checking the tire pressure (manually) ..... 356
- Checking the tire pressure (tire pressure monitoring system) ..... 358
- Definitions ..... 370
- DOT, Tire Identification Number (TIN) ..... 366
- Flat tire ..... 332
- Installing ..... 380
- Load index ..... 368
- Load-bearing capacity ..... 368
- Maximum tire load ..... 367
- Maximum tire pressure ..... 367
- MOExtended tires ..... 333
- Noise ..... 352
- Notes on installing ..... 373
- Overview of tire labeling ..... 365
- Removing ..... 380
- Replacing ..... 373, 377
- Restarting the tire pressure loss warning system ..... 360
- Restarting the tire pressure monitoring system ..... 359
- Selection ..... 373
- Snow chains ..... 353
- Speed rating ..... 368
- Storing ..... 376
- Temperature grade ..... 365
- Tire and Loading Information placard ..... 360
- Tire pressure (Notes) ..... 354
- Tire pressure loss warning system (function) ..... 359
- Tire pressure monitoring system (function) ..... 357
- Tire pressure table ..... 355
- Tire Quality Grading ..... 365
- Tire size designation ..... 368
- TIREFIT kit ..... 334
- Traction grade ..... 365
- Tread wear grade ..... 365
- Unusual handling characteristics ..... 352
- Tool**  
see Vehicle tool kit
- Top Tether** ..... 53
- Total distance** ..... 204  
Displaying ..... 204
- Touch Control**  
On-board computer ..... 200  
Operating ..... 224
- Setting the sensitivity ..... 224
- Touchpad**  
Activating/deactivating ..... 225  
Activating/deactivating haptic operation feedback ..... 226  
Operating ..... 225  
Reading the handwriting recognition aloud ..... 226  
Selecting a station and track ..... 226  
Setting the sensitivity ..... 226
- Tow-starting** ..... 348
- Towing a trailer**  
Active Blind Spot Assist ..... 193
- Towing away** ..... 344
- Towing eye**  
Installing ..... 348  
Storage location ..... 347
- Towing methods** ..... 343
- Track**  
Selecting (audio mode) ..... 296
- Traction grade** ..... 365
- Traffic information** ..... 261  
Displaying the traffic map ..... 261

- Displaying traffic incidents ..... 262
  - Issuing hazard alerts ..... 263
  - Live Traffic Information ..... 261
  - Overview ..... 261
  - Traffic map**  
see Map
  - Traffic Sign Assist** ..... 191
    - Function/notes ..... 191
    - Setting ..... 192
    - System limitations ..... 191
  - Transferred vehicle data**
    - Android Auto ..... 282
    - Apple CarPlay™ ..... 282
  - Transmission position display** ..... 139
  - Transporting**
    - Vehicle ..... 346
  - Tread wear grade** ..... 365
  - Trim element (Care)** ..... 329
  - Trip**
    - Menu (on-board computer) ..... 204
  - Trip computer**
    - Displaying ..... 204
    - Resetting ..... 206
  - Trip distance** ..... 204
    - Displaying ..... 204
    - Resetting ..... 206
  - Trip odometer**  
see Trip distance
  - Trunk lid**
    - Activating/deactivating the trunk lid  
opening height restriction ..... 71
    - Closing ..... 66
    - Emergency release (from inside) ..... 70
    - HANDS-FREE ACCESS ..... 69
    - Locking separately ..... 70
    - Opening ..... 65
    - Opening dimensions ..... 393
  - Trunk separator**
    - Closing ..... 78
    - Opening ..... 78
  - Turn signal indicator**  
see Turn signals
  - Turn signals** ..... 112
    - Activating/deactivating ..... 112
  - Two-way radios**
    - Frequencies ..... 384
    - Notes on installation ..... 383
  - Transmission output (maximum) ..... 384
- U**
- Units of measurement**
    - Setting ..... 237
  - Unlocking setting** ..... 58
  - USB devices**
    - Connecting ..... 296
  - User profile** ..... 239
    - Creating ..... 239
    - Importing/exporting ..... 239
    - Options ..... 240
    - Selecting ..... 239
  - Using the telephone**  
see Calls
- V**
- Vehicle** ..... 132, 133
    - Activating/deactivating standby  
mode ..... 153
    - Correct use ..... 25
    - Data acquisition ..... 26
    - Diagnostics connection ..... 24
    - Equipment ..... 20

- Limited Warranty ..... 26
  - Locking (automatically) ..... 64
  - Locking (emergency key) ..... 64
  - Locking (from the inside) ..... 62
  - Locking (KEYLESS-GO) ..... 62
  - Lowering ..... 381
  - Maintenance ..... 21
  - Parking ..... 152
  - Problem notification ..... 25
  - QR code rescue card ..... 26
  - Qualified specialist workshop ..... 25
  - Raising ..... 378
  - Starting (emergency operation mode) ..... 132
  - Starting (Remote Online) ..... 133
  - Starting (start/stop button) ..... 132
  - Switching off (start/stop button) ..... 145
  - Unlocking (from the inside) ..... 62
  - Unlocking (KEYLESS-GO) ..... 62
  - Ventilating (convenience opening) ..... 73
  - Voice commands (Voice Control System) ..... 221
- Vehicle**  
see Locking/unlocking
- Vehicle data**
- Displaying (DYNAMIC SELECT) ..... 139
  - Roof load ..... 394
  - Turning radius ..... 393
  - Vehicle height ..... 393
  - Vehicle length ..... 393
  - Vehicle width ..... 393
  - Wheelbase ..... 393
- Vehicle data storage**
- COMAND/mbrace ..... 28
  - Electronic control units ..... 26
  - Event data recorders ..... 28
  - Service providers ..... 28
- Vehicle dimensions** ..... 393
- Vehicle electronics**
- Notes ..... 383
  - Two-way radios ..... 383
- Vehicle identification number**  
see VIN
- Vehicle identification plate**
- Paint code ..... 385
  - VIN ..... 385
- Vehicle identification plate**  
see Model series
- Vehicle interior**
- Cooling or heating (Remote Online) ..... 133
- Vehicle key**  
see SmartKey
- Vehicle maintenance**  
see ASSYST PLUS
- Vehicle operation**  
Outside the USA or Canada ..... 21
- Vehicle position**  
Transmitting ..... 233
- Vehicle tool kit** ..... 334
- TIREFIT kit ..... 334
  - Towing eye ..... 347
- Ventilating**  
Convenience opening ..... 73
- Ventilation**  
see Climate control
- Vents**  
see Air vents
- Video mode** ..... 299
- Activating ..... 297
  - Activating/deactivating full-screen mode ..... 299

Overview .....	298
Settings .....	299
<b>VIN</b> .....	385
Identification plate .....	385
Seat .....	385
Windshield .....	385
<b>Visibility</b>	
Defrosting the windows .....	126
<b>Voice command types (Voice Control System)</b> .....	213
<b>Voice Control System</b> .....	212
Application specific voice commands ..	213
Audible help functions .....	214
Entering numbers .....	214
Global voice commands .....	213
Improving speech quality .....	214
Language setting .....	214
Media player voice commands .....	220
Message voice commands .....	220
Multifunction steering wheel (operating) .....	212
Navigation voice commands .....	216
Operable functions .....	213
Operating safety .....	212

Radio voice commands .....	219
Switch voice commands .....	214
Telephone voice controls .....	218
Text message voice commands .....	220
Types of voice commands .....	213
Vehicle voice commands .....	221
Voice prompting .....	213

## W







### Warning lamp













see Warning/indicator lamps

### Warning system

see ATA (anti-theft alarm system)

### Warning/indicator lamp

 ABS warning lamp .....	448
 Brake warning lamp (USA) .....	446
 Brakes warning lamp (Canada) ....	446
 Coolant warning lamp .....	457
 Distance warning lamp .....	454
 Electrical malfunction warning lamp .....	455
 Engine diagnosis warning lamp ...	455

 ESP® OFF warning lamp .....	450
 ESP® warning lamp flashes .....	448
 ESP® warning lamp lights up .....	449
 Fuel reserve warning lamp ..	455, 456
 Power steering system warning lamp .....	454
 Red indicator lamp, electric parking brake applied (Canada only) ....	451
 Red indicator lamp, electric parking brake applied (USA only) .....	451
 Restraint system warning lamp ...	452
 Seat belt warning lamp flashes ...	453
 Seat belt warning lamp lights up .....	453
 Suspension warning lamp .....	453
 Tire pressure monitoring system warning lamp flashes .....	460
 Tire pressure monitoring system warning lamp lights up .....	459





- Unusual handling characteristics ..... 352
- Wi-Fi**
  - Overview ..... 233
  - Setting ..... 234
  - Setting up a hotspot ..... 235
  - Setting up an Internet connection ..... 285
- Wind deflector**
  - Care ..... 325
- Wind screen**
  - Care ..... 326
- Window lifter**
  - see Side windows
- Windows**
  - Closing (all) ..... 71
  - Opening (all) ..... 71
- Windows**
  - see Side windows
- Windows (Care)** ..... 327
- Windshield** ..... 119
  - Defrosting ..... 124
  - Replacing the wiper blades ..... 117
  - Replacing wiper blades (MAGIC VISION CONTROL) ..... 119
- Windshield**
  - see Windshield
- Windshield washer fluid** ..... 391
  - Notes ..... 391
- Windshield washer system**
  - Refilling ..... 320
- Windshield wipers**
  - Replacing the wiper blades ..... 117
  - Replacing wiper blades (MAGIC VISION CONTROL) ..... 119
  - Switching on/off ..... 117
- Winter operation**
  - Snow chains ..... 353
- Wiper blades**
  - Care ..... 327
  - Replacing ..... 117
  - Replacing (MAGIC VISION CONTROL) .. 119
- Wireless charging**
  - Function/notes ..... 108
  - Mobile phone ..... 109
- Wireless vehicle components**
  - Declaration of conformity ..... 23
- Workshop**
  - see Qualified specialist workshop