



GL

Operator's Manual



Order no. P166 0038 13 Part no. 1665847202 Edition A 2016

GL Operator's Manual



Mercedes-Benz

## Symbols

Registered trademarks:

- Bluetooth® is a registered trademark of Bluetooth SIG Inc.
- DTS is a registered trademark of DTS, Inc.
- Dolby and MLP are registered trademarks of DOLBY Laboratories.
- BabySmart™, ESP® and PRE-SAFE® are registered trademarks of Daimler AG.
- HomeLink® is a registered trademark of Johnson Controls.
- iPod® and iTunes® are registered trademarks of Apple Inc.
- Logic7® is a registered trademark of Harman International Industries.
- Microsoft® and Windows media® are registered trademarks of Microsoft Corporation.
- SIRIUS is a registered trademark of Sirius XM Radio Inc.
- HD Radio is a registered trademark of iBiquity Digital Corporation.
- Gracenote® is a registered trademark of Gracenote, Inc.
- ZAGATSurvey® and related brands are registered trademarks of ZagatSurvey, LLC.

In this Operator's Manual you will find the following symbols:

### **WARNING**

Warning notes make you aware of dangers which could pose a threat to your health or life, or to the health and life of others.

### **Environmental note**

Environmental notes provide you with information on environmentally aware actions or disposal.

 Notes on material damage alert you to dangers that could lead to damage to your vehicle.

 Practical tips or further information that could be helpful to you.

▶ This symbol indicates an instruction that must be followed.

▶ Several of these symbols in succession indicate an instruction with several steps.

(▶ This symbol tells you where you can find more information about a topic.

▶▶ This symbol indicates a warning or an instruction that is continued on the next page.

Dis-  
play This text indicates a message in the multifunction/COMAND/Audio display.



This symbol tells you that you can find further information in the Digital Operator's Manual.

## Publication details

### Internet

Further information about Mercedes-Benz vehicles and about Daimler AG can be found on the following websites:

<http://www.mbusa.com> (USA only)

<http://www.mercedes-benz.ca> (Canada only)

### Editorial office

©Daimler AG: not to be reprinted, translated or otherwise reproduced, in whole or in part, without written permission from Daimler AG.

### Vehicle manufacturer

Daimler AG  
Mercedesstraße 137  
70327 Stuttgart  
Germany



## Welcome to the world of Mercedes-Benz

We urge you to read this Operator's Manual carefully and familiarize yourself with the vehicle before driving. For your own safety and a longer vehicle life, follow the instructions and warning notices in this manual.

Ignoring them could result in damage to the vehicle or personal injury to you or others.

Vehicle damage caused by failure to follow instructions is not covered by the Mercedes-Benz Limited Warranty.

This Operator's Manual provides information on the most important functions of your vehicle.

Additional information on convenience functions can be found in COMAND in your Digital Operator's Manual.

The equipment or product designation of your vehicle may vary depending on:

- model
- order
- country specification
- availability

Mercedes-Benz therefore reserves the right to introduce changes in the following areas:

- design
- equipment
- technical features

The equipment in your vehicle may therefore differ from that shown in the descriptions and illustrations.

The following are integral components of the vehicle:

- Digital Operator's Manual
- Operator's Manual
- Maintenance Booklet
- Equipment-dependent supplements

Keep these documents in the vehicle at all times. If you sell the vehicle, always pass all documents on to the new owner.

You can also use the Mercedes-Benz Guide App:



Apple® iOS



Android™

Please note that the Mercedes-Benz Guides App may not yet be available in your country.

The technical documentation team at Daimler AG wishes you safe and pleasant motoring.

Mercedes-Benz USA, LLC

Mercedes-Benz Canada, Inc.

A Daimler Company

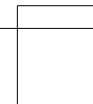
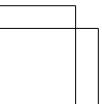
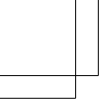

<b>Index</b> .....	<b>4</b>	<b>At a glance</b> .....	<b>39</b>	
<b>Digital Operator's Manual</b> .....	<b>25</b>	<b>Safety</b> .....	<b>49</b>	
<b>Introduction</b> .....	<b>30</b>	<b>Opening and closing</b> .....	<b>87</b>	
		<b>Seats, steering wheel and mirrors</b> ..	<b>107</b>	
		<b>Lights and windshield wipers</b> .....	<b>113</b>	
		<b>Climate control</b> .....	<b>123</b>	
		<b>Driving and parking</b> .....	<b>133</b>	
		<b>On-board computer and displays</b> ....	<b>197</b>	
		<b>COMAND</b> .....	<b>227</b>	
		<b>Stowage and features</b> .....	<b>247</b>	
		<b>Maintenance and care</b> .....	<b>265</b>	
		<b>Breakdown assistance</b> .....	<b>273</b>	
		<b>Wheels and tires</b> .....	<b>291</b>	
		<b>Technical data</b> .....	<b>329</b>	

## 1, 2, 3 ...

**4ETS (Electronic Traction System)**

see ETS/4ETS (Electronic Traction System)

**4MATIC (permanent four-wheel**

**drive)** ..... 186

**12 V socket**

see Sockets

**115 V socket** ..... 255

**360° camera**

Cleaning ..... 272

Function/notes ..... 172

**A****ABS (Anti-lock Braking System)**

Display message ..... 202

Function/notes ..... 74

Important safety notes ..... 74

Warning lamp ..... 217

**Access data of the mobile phone****network provider**

Making entries ..... 241

Selecting ..... 240

**Accident**

Automatic measures after an accident ..... 66

**Activating/deactivating cooling**

**with air dehumidification** ..... 131

**Active Blind Spot Assist**

Display message ..... 201

Function/information ..... 180

**Active Curve System**

Display message ..... 201

Function/notes ..... 165

**Active Driving Assistance package ..** 180

**Active Lane Keeping Assist**

Display message ..... 201

Function/information ..... 183

**Active Parking Assist**

Display message ..... 201

Function/notes ..... 169

Important safety notes ..... 169

Towing a trailer ..... 170

**ADAPTIVE BRAKE** ..... 82

**Adaptive Brake Assist**

Function/notes ..... 78

**Adaptive Highbeam Assist**

Display message ..... 201

Function/notes ..... 115

Switching on/off ..... 116

**Additives (engine oil)** ..... 337

**Address book**

see also Digital Operator's Manual ..... 228

**ADS (Adaptive Damping System)**

Function/notes ..... 165

**Air bags**

Deployment ..... 64

Display message ..... 201, 207

Front air bag (driver, front

passenger) ..... 57

Important safety notes ..... 56

Introduction ..... 56

Knee bag ..... 58

Occupant Classification System

(OCS) ..... 59

PASSENGER AIR BAG OFF indica-

tor lamp ..... 51

Side impact air bag ..... 58

Window curtain air bag ..... 59

**Air filter (display message)** ..... 201

**AIR FLOW** ..... 131

**Air-conditioning system**

see Climate control

**AIRMATIC (display message)** ..... 201

**AIRMATIC package**

ADS (Adaptive Damping System) ... 165

Function/notes ..... 165

Level control ..... 165

**Alarm**

ATA (Anti-Theft Alarm system) ..... 84

Switching off (ATA) ..... 84

Switching the function on/off

(ATA) ..... 84

**Alarm system**

see ATA (Anti-Theft Alarm system)

**Ambient lighting**

Setting the brightness (on-board computer) ..... 199

Setting the color (on-board computer) ..... 199

**AMG adaptive sport suspension**

**system** ..... 167



- AMG menu (on-board computer) .....** 199
- Anti-lock braking system**  
see ABS (Anti-lock Braking System)
- Anti-Theft Alarm system**  
see ATA (Anti-Theft Alarm system)
- Approach/departure angle .....** 154
- Ashtray .....** 255
- Assistance display (on-board computer) .....** 199
- Assistance menu (on-board computer) .....** 199
- ASSYST PLUS**  
Displaying a service message ..... 270  
Driving abroad ..... 270  
Hiding a service message ..... 270  
Resetting the service interval display ..... 270  
Service message ..... 270  
Special service requirements ..... 270
- ATA (Anti-Theft Alarm system)**  
Activating/deactivating ..... 84  
Function ..... 84  
Switching off the alarm ..... 84
- ATTENTION ASSIST**  
Activating/deactivating ..... 199  
Display message ..... 201  
Function/notes ..... 174
- Audio menu (on-board computer) ....** 199
- Audio system**  
see separate operating instructions
- Authorized Mercedes-Benz Center**  
see Qualified specialist workshop
- Authorized workshop**  
see Qualified specialist workshop
- AUTO lights**  
Display message ..... 201  
see Lights
- Automatic car wash (care) .....** 271
- Automatic engine start (ECO start/stop function) .....** 139
- Automatic engine switch-off (ECO start/stop function) .....** 139
- Automatic transmission**  
Accelerator pedal position ..... 141  
Automatic drive program ..... 141  
Changing gear ..... 141  
DIRECT SELECT lever ..... 140  
Display message ..... 201  
Drive program display ..... 140  
Driving tips ..... 141  
Emergency running mode ..... 141  
Engaging drive position ..... 140  
Engaging neutral ..... 140  
Engaging park position automatically ..... 140  
Engaging reverse gear ..... 140  
Engaging the park position ..... 140  
Kickdown ..... 141  
Manual drive program ..... 141  
Manual drive program (Mercedes-AMG vehicles) ..... 141  
Manual drive program (vehicles with the ON&OFFROAD package) .. 141  
Oil temperature (on-board computer, Mercedes-AMG vehicles) ..... 199  
Overview ..... 140  
Problem (malfunction) ..... 141  
Program selector button ..... 141  
Pulling away ..... 138  
Starting the engine ..... 137  
Steering wheel paddle shifters ..... 141  
Trailer towing ..... 141  
Transmission position display ..... 140  
Transmission positions ..... 141
- Automatic transmission emergency mode .....** 141
- Axle load, permissible (trailer towing) .....** 344
- B**
- Back button .....** 236
- Backup lamp**  
Display message ..... 201
- Bag hook .....** 252
- Ball coupling**  
Installing ..... 192  
Removing ..... 196
- BAS (Brake Assist System) .....** 75
- BAS PLUS (Brake Assist System PLUS) .....** 75
- Battery (SmartKey)**  
Checking ..... 91  
Important safety notes ..... 90  
Replacing ..... 91

- Battery (vehicle)**  
 Charging ..... 282  
 Display message ..... 201  
 Important safety notes ..... 279  
 Jump starting ..... 283  
 Overview ..... 279
- Belt**  
 see Seat belts
- Blind Spot Assist**  
 Activating/deactivating ..... 199  
 Display message ..... 201  
 Notes/function ..... 177  
 see Active Blind Spot Assist
- BlueTEC**  
 Adding DEF ..... 145
- BlueTEC (DEF)** ..... 336
- Bluetooth®**  
 see also Digital Operator's Manual ..... 228
- Brake Assist**  
 see BAS (Brake Assist System)
- Brake fluid**  
 Display message ..... 205  
 Notes ..... 337
- Brake force distribution**  
 see EBD (electronic brake force distribution)
- Brake lamps**  
 Changing bulbs ..... 119  
 Display message ..... 201
- Brakes**  
 ABS ..... 74  
 Adaptive Brake Assist ..... 78  
 BAS ..... 75  
 BAS PLUS ..... 75  
 Brake fluid (notes) ..... 337  
 Display message ..... 202  
 High-performance brake system .... 151  
 Important safety notes ..... 151  
 Maintenance ..... 151  
 Parking brake ..... 149  
 Riding tips ..... 151  
 Warning lamp ..... 216
- Breakdown**  
 Where will I find...? ..... 274  
 see Flat tire  
 see Towing away
- Brightness control (instrument cluster lighting)** ..... 41
- Bulbs**  
 see Replacing bulbs
- Buttons on the COMAND controller** ..... 236
- C**
- California**  
 Important notice for retail customers and lessees ..... 32
- Calling up a malfunction**  
 see Display messages
- Car**  
 see Vehicle
- Car key**  
 see SmartKey
- Care**  
 360° camera ..... 272  
 Car wash ..... 271  
 Carpets ..... 272  
 Display ..... 272  
 Exterior lights ..... 272  
 Gear or selector lever ..... 272  
 Interior ..... 272  
 Matte finish ..... 272  
 Night View Assist Plus ..... 272  
 Notes ..... 270  
 Paint ..... 272  
 Plastic trim ..... 272  
 Power washer ..... 272  
 Rear view camera ..... 272  
 Roof lining ..... 272  
 Seat belt ..... 272  
 Seat cover ..... 272  
 Sensors ..... 272  
 Side running board ..... 272  
 Tail pipes ..... 272  
 Trim pieces ..... 272  
 Washing by hand ..... 272  
 Wheels ..... 272  
 Windows ..... 272  
 Wiper blades ..... 272  
 Wooden trim ..... 272
- Cargo compartment cover**  
 Notes/how to use ..... 253

- Cargo compartment enlargement**
  - Important safety notes ..... 250
- Cargo compartment floor**
  - Important safety notes ..... 253
  - Opening/closing ..... 254
  - Stowage well (under) ..... 253
- Cargo tie down rings** ..... 252
- CD**
  - see also Digital Operator's Manual ..... 228
- CD player (on-board computer)** ..... 199
- Center console**
  - Lower section ..... 45
  - Upper section ..... 44
- Central locking**
  - Automatic locking (on-board computer) ..... 199
  - Locking/unlocking (SmartKey) ..... 88
- Changing bulbs**
  - Brake lamps ..... 119
  - High-beam headlamps ..... 118
  - Low-beam headlamps ..... 118
- Child**
  - Restraint system ..... 68
- Child seat**
  - Forward-facing restraint system ..... 72
  - LATCH-type (ISOFIX) child seat anchors ..... 69
  - On the front-passenger seat ..... 71
  - Rearward-facing restraint system .... 72
  - Top Tether ..... 70
- Child-proof locks**
  - Important safety notes ..... 72
  - Rear doors ..... 73
- Children**
  - Special seat belt retractor ..... 67
- Cigarette lighter** ..... 255
- Cleaning**
  - Mirror turn signal ..... 272
  - Trailer tow hitch ..... 272
- Clear button** ..... 236
- Climate control**
  - 3-zone automatic climate control with additional rear-compartment climate control ..... 129
  - Automatic climate control (3-zone) ..... 127
  - Controlling automatically ..... 131
  - Cooling with air dehumidification .. 131
  - Defrosting the windows ..... 131
  - Defrosting the windshield ..... 131
  - Dual-zone automatic climate control ..... 125
  - General notes ..... 124
  - Indicator lamp ..... 131
  - Maximum cooling ..... 131
  - Overview of systems ..... 124
  - Problem with the rear window defroster ..... 131
  - Problems with cooling with air dehumidification ..... 131
  - Rear control panel ..... 127
  - Rear control panel (3-zone automatic climate control with additional rear-compartment climate control) ..... 129
  - Refrigerant ..... 339
  - Refrigerant filling capacity ..... 340
  - Setting the air distribution ..... 131
  - Setting the air vents ..... 131
  - Setting the airflow ..... 131
  - Setting the climate mode (AIR FLOW) ..... 131
  - Setting the temperature ..... 131
  - Switching air-recirculation mode on/off ..... 131
  - Switching on/off ..... 131
  - Switching residual heat on/off ..... 131
  - Switching the rear window defroster on/off ..... 131
  - Switching the ZONE function on/off ..... 131
- Coat hooks** ..... 253
- Cockpit**
  - Overview ..... 40
  - see Instrument cluster
- COLLISION PREVENTION ASSIST**
  - Operation/notes ..... 76
- COMAND**
  - Display ..... 231
  - Examples of operation ..... 236
  - Menu overview ..... 232
  - ON&OFFROAD menu ..... 189
- COMAND and Internet**
  - see Online and Internet functions
- COMAND control panel** ..... 234

<b>COMAND controller</b> .....	235
<b>Combination switch</b> .....	115
<b>Connecting a USB device</b>	
see also Digital Operator's Manual .....	228
<b>Consumption statistics (on-board computer)</b> .....	199
<b>Coolant (engine)</b>	
Checking the level .....	269
Display message .....	209
Filling capacity .....	339
Important safety notes .....	338
Temperature (on-board computer, Mercedes-AMG vehicles) .....	199
Temperature gauge .....	198
Warning lamp .....	223
<b>Cooling</b>	
see Climate control	
<b>Copyright</b> .....	37
<b>Cornering light function</b>	
Display message .....	201
Function/notes .....	115
<b>Crash-responsive emergency lighting</b> .....	116
<b>Crosswind Assist</b> .....	81
<b>Crosswind driving assistance</b> .....	81
<b>Cruise control</b>	
Activation conditions .....	155
Cruise control lever .....	155
Deactivating .....	155
Display message .....	201
Driving system .....	155
Function/notes .....	155
Important safety notes .....	155
Selecting .....	155
Setting a speed .....	155
Storing and maintaining current speed .....	155
<b>Cup holder</b>	
Center console .....	255
Important safety notes .....	255
Rear compartment .....	255
Temperature controlled .....	255
Third row of seats .....	255
<b>Customer Assistance Center (CAC)</b> .....	35
<b>Customer Relations Department</b> .....	35

## D

### Data

see Technical data

### Daytime running lamps

Display message .....	201
Switching on/off (on-board computer) .....	199

### Declarations of conformity

### DEF

Adding .....	145
Display message .....	201
Filling capacity .....	336
Important safety notes .....	336

### Delayed switch-off

Exterior lighting (on-board computer) .....	199
Interior lighting .....	199

### Diagnostics connection

### Differential lock (display message)

### Digital Operator's Manual

Contents .....	28
Installation .....	25
Introduction .....	25
Keyword search .....	27
Operating notes .....	26
Visual search .....	26

### Digital speedometer

### DIRECT SELECT lever

Automatic transmission .....	140
------------------------------	-----

### Display (cleaning instructions)

### Display messages

ASSYST PLUS .....	270
Calling up (on-board computer) .....	201
Driving systems .....	210
Engine .....	209
General notes .....	201
Hiding (on-board computer) .....	201
KEYLESS-GO .....	201
Lights .....	201
Safety systems .....	202
SmartKey .....	201
Tires .....	211
Vehicle .....	213

### Distance recorder

see Trip odometer



- Distance warning (warning lamp) ....** 224
- Distance warning function**
  - Activating/deactivating ..... 199
  - Function/notes ..... 76
  - Warning lamp ..... 224
- DISTRONIC**
  - Display message ..... 201
- DISTRONIC PLUS**
  - Activating ..... 158
  - Activation conditions ..... 158
  - Cruise control lever ..... 158
  - Deactivating ..... 160
  - Display message ..... 201
  - Displays in the multifunction display ..... 160
  - Driving tips ..... 161
  - Function/notes ..... 156
  - Important safety notes ..... 156
  - Setting the specified minimum distance ..... 160
  - Stopping ..... 159
  - Warning lamp ..... 224
- Doors**
  - Automatic locking (on-board computer) ..... 199
  - Automatic locking (switch) ..... 95
  - Central locking/unlocking (SmartKey) ..... 88
  - Control panel ..... 48
  - Display message ..... 201
  - Emergency locking ..... 96
  - Emergency unlocking ..... 95
  - Important safety notes ..... 95
  - Opening (from inside) ..... 95
  - Overview ..... 95
  - Power closing feature ..... 95
- Drinking and driving** ..... 150
- Drive program**
  - Automatic ..... 141
  - Display (DIRECT SELECT lever) ..... 140
  - Manual ..... 141
  - Manual (Mercedes-AMG vehicles) ..... 141
  - Manual (vehicles with the ON&OFFROAD package) ..... 141
  - Off-road program (vehicles with the ON&OFFROAD package) ..... 188
  - SETUP (on-board computer) ..... 199
- see On-road programs
- Driver's door**
  - see Doors
- Driving abroad**
  - Mercedes-Benz Service ..... 270
- Driving in mountainous terrain**
  - Approach/departure angle ..... 154
- Driving lamps**
  - see Daytime running lamps
- Driving off-road**
  - see Off-road driving
- Driving safety systems**
  - ABS (Anti-lock Braking System) ..... 74
  - ADAPTIVE BRAKE ..... 82
  - Adaptive Brake Assist ..... 78
  - BAS (Brake Assist System) ..... 75
  - BAS PLUS (Brake Assist System PLUS) ..... 75
  - COLLISION PREVENTION ASSIST .... 76
  - Distance warning function ..... 76
  - EBD (electronic brake force distribution) ..... 81
  - ESP® (Electronic Stability Program) ..... 79
  - Important safety information ..... 74
  - Overview ..... 74
  - PRE-SAFE® Brake ..... 82
  - STEER CONTROL ..... 83
- Driving systems**
  - 360° camera ..... 172
  - Active Blind Spot Assist ..... 180
  - Active Curve System ..... 165
  - Active Driving Assistance package ..... 180
  - Active Lane Keeping Assist ..... 183
  - Active Parking Assist ..... 169
  - ADS ..... 165
  - AIRMATIC package ..... 165
  - AMG adaptive sport suspension system ..... 167
  - ATTENTION ASSIST ..... 174
  - Blind Spot Assist ..... 177
  - Cruise control ..... 155
  - Display message ..... 210
  - DISTRONIC PLUS ..... 156
  - HOLD function ..... 164
  - Lane Keeping Assist ..... 179

- Level control (vehicles with AIR-MATIC package) ..... 165
  - Level control (vehicles with the ON&OFFROAD package) ..... 162
  - On-road programs ..... 185
  - PARKTRONIC ..... 168
  - Rear view camera ..... 170
  - Driving tips**
    - Automatic transmission ..... 141
    - Brakes ..... 151
    - Break-in period ..... 134
    - DISTRONIC PLUS ..... 161
    - Downhill gradient ..... 151
    - Drinking and driving ..... 150
    - Driving in winter ..... 151
    - Driving on flooded roads ..... 151
    - Driving on sand ..... 154
    - Driving on wet roads ..... 151
    - Driving over obstacles ..... 154
    - Exhaust check ..... 150
    - Fuel ..... 150
    - General ..... 150
    - Hydroplaning ..... 151
    - Icy road surfaces ..... 151
    - Limited braking efficiency on salted roads ..... 151
    - Off-road driving ..... 153
    - Off-road fording ..... 151
    - Snow chains ..... 295
    - Tire ruts ..... 154
    - Towing a trailer ..... 191
    - Traveling uphill ..... 154
    - Wet road surface ..... 151
  - DSR (Downhill Speed Regulation)**
    - Display message ..... 201
    - Function/notes ..... 187
  - DVD video**
    - Operating (on-board computer) .... 199
    - see also Digital Operator's Manual ..... 228
- E**
- EASY-ENTRY feature**
    - Activating/deactivating ..... 199
    - Function/notes ..... 111
  - EASY-EXIT feature**
    - Function/notes ..... 111
  - Switching on/off ..... 199
  - EBD (electronic brake force distribution)**
    - Display message ..... 204
    - Function/notes ..... 81
  - ECO display**
    - Function/notes ..... 151
  - ECO start/stop function**
    - Automatic engine start ..... 139
    - Automatic engine switch-off ..... 139
    - Deactivating/activating ..... 139
    - General information ..... 139
    - Important safety notes ..... 139
    - Introduction ..... 139
  - Electronic Stability Program**
    - see ESP<sup>®</sup> (Electronic Stability Program)
  - Emergency**
    - Automatic measures after an accident ..... 66
  - Emergency release**
    - Driver's door ..... 95
    - Vehicle ..... 95
  - Emergency spare wheel**
    - General notes ..... 325
    - Important safety notes ..... 325
    - Removing ..... 326
    - Storage location ..... 326
    - Technical data ..... 328
  - Emergency Tensioning Devices**
    - Activation ..... 64
  - Emergency unlocking**
    - Tailgate ..... 100
  - Emissions control**
    - Service and warranty information .... 31
  - Engine**
    - Check Engine warning lamp ..... 214
    - Display message ..... 209
    - ECO start/stop function ..... 139
    - Engine number ..... 333
    - Irregular running ..... 139
    - Jump-starting ..... 283
    - Starting (important safety notes) ... 137
    - Starting problems ..... 139
    - Starting the engine with the SmartKey ..... 137
    - Starting with KEYLESS-GO ..... 138
    - Switching off ..... 149

- Tow-starting (vehicle) ..... 288
  - Engine electronics**
    - Problem (malfunction) ..... 139
  - Engine jump starting**
    - see Jump starting (engine)
  - Engine oil**
    - Adding ..... 268
    - Additives ..... 337
    - Checking the oil level ..... 267
    - Checking the oil level using the dipstick ..... 267
    - Display message ..... 201
    - Filling capacity ..... 337
    - Notes about oil grades ..... 336
    - Notes on oil level/consumption .... 267
    - Temperature (on-board computer, Mercedes-AMG vehicles) ..... 199
    - Viscosity ..... 337
  - Entering an address**
    - see also Digital Operator's Manual ..... 228
  - ESP® (Electronic Stability Program)**
    - AMG menu (on-board computer) ... 199
    - Characteristics ..... 80
    - Deactivating/activating ..... 80
    - Display message ..... 202
    - Function/notes ..... 79
    - General notes ..... 79
    - Important safety information ..... 79
    - Trailer stabilization ..... 81
    - Warning lamp ..... 220
  - ETS/4ETS (Electronic Traction System)** ..... 79
  - Exhaust check** ..... 150
  - Exhaust tail pipe (cleaning instructions)** ..... 272
  - Exterior lighting**
    - see Lights
  - Exterior mirrors**
    - Adjusting ..... 112
    - Dipping (automatic) ..... 112
    - Folding in when locking (on-board computer) ..... 199
    - Folding in/out (automatically) ..... 112
    - Folding in/out (electrically) ..... 112
    - Out of position (troubleshooting) ... 112
  - Setting ..... 112
  - Storing settings (memory function) ..... 112
  - Storing the parking position ..... 112
  - Eyeglasses compartment** ..... 249
- F**
- Filler cap**
    - see Fuel filler flap
  - Flat tire**
    - MOExtended tires ..... 275
    - Preparing the vehicle ..... 275
    - TIREFIT kit ..... 276
    - see Emergency spare wheel
  - Floormats** ..... 264
  - Folding the rear bench seat forwards/back** ..... 250
  - Fording**
    - Off-road ..... 151
    - On flooded roads ..... 151
  - Frequencies**
    - Mobile phone ..... 330
    - Two-way radio ..... 330
  - Fuel**
    - Additives ..... 335
    - Consumption statistics ..... 199
    - Displaying the current consumption ..... 199
    - Displaying the range ..... 199
    - Driving tips ..... 150
    - Fuel gauge ..... 41, 198
    - Grade (gasoline) ..... 334
    - Important safety notes ..... 333
    - Low outside temperatures ..... 336
    - Problem (malfunction) ..... 145
    - Quality (diesel) ..... 335
    - Refueling ..... 142
    - Tank content/reserve fuel ..... 334
  - Fuel filler flap**
    - Opening ..... 144
  - Fuel filter (display message)** ..... 201
  - Fuel level**
    - Calling up the range (on-board computer) ..... 199
  - Fuel tank**
    - Capacity ..... 334
    - Problem (malfunction) ..... 145

**Fuses**

Allocation chart .....	288
Before changing .....	288
Dashboard fuse box .....	288
Fuse box in the engine compartment .....	289
Fuse box under rear bench seat ....	289
Important safety notes .....	288

**G****Garage door opener**

Clearing the memory .....	263
General notes .....	260
Important safety notes .....	261
Opening/closing the garage door ..	263
Programming (button in the rear-view mirror) .....	261
Synchronizing the rolling code .....	262

**Gear indicator (on-board computer, Mercedes-AMG vehicles) .....****Gear or selector lever (cleaning guidelines) .....****Genuine parts .....****Glove box .....****Google™ Local Search**

see also Digital Operator's Manual .....	228
--	-----

**GTW (Gross Trailer Weight) (definition) .....****H****Handbrake**

see Parking brake

**Hazard warning lamps .....****Head bags**

Display message .....	201
-----------------------	-----

**Head restraints**

Adjusting .....	110
Adjusting (rear) .....	110
Installing/removing (rear) .....	110

**Headlamps**

Fogging up .....	114
------------------	-----

**Heating**

see Climate control

**High-beam headlamps**

Adaptive Highbeam Assist .....	115
--------------------------------	-----

Changing bulbs .....	118
Display message .....	201
Switching on/off .....	115

**Hill start assist .....****HOLD function**

Deactivating .....	165
Display message .....	201
Function/notes .....	164

**Home address**

see also Digital Operator's Manual .....	228
--	-----

**Hood**

Closing .....	267
Display message .....	213
Important safety notes .....	266
Opening .....	266

**Horn .....****Hydroplaning .....****I****Ignition lock**

see Key positions

**Immobilizer .....****Indicator lamps**

see Warning and indicator lamps

**Indicators**

see Turn signals

**Insect protection on the radiator ....****Instrument cluster**

Overview .....	41, 198
Warning and indicator lamps .....	42

**Instrument cluster lighting .....****Interior lighting**

Automatic control .....	116
Delayed switch-off (on-board computer) .....	199
Emergency lighting .....	116
Manual control .....	116
Overview .....	116
Reading lamp .....	116
Setting the brightness of the ambient lighting (on-board computer) .....	199
Setting the color of the ambient lighting (on-board computer) .....	199

**Internet**

Calling up the carousel view .....	244
------------------------------------	-----



- Conditions for access ..... 237
  - Entering the URL ..... 244
  - Selecting/setting access data ..... 239
  - Internet radio**
  - Calling up ..... 243
  - Searching for stations ..... 244
  - iPod®**
  - see also Digital Operator's Manual ..... 228
- J**
- Jack**
  - Storage location ..... 274
  - Using ..... 316
  - Jump starting (engine)** ..... 283
- K**
- Key positions**
  - KEYLESS-GO ..... 135
  - SmartKey ..... 135
  - KEYLESS-GO**
  - Deactivation ..... 89
  - Display message ..... 201
  - Locking ..... 89
  - Removing the Start/Stop button ... 136
  - Start/Stop button ..... 135
  - Starting the engine ..... 138
  - Unlocking ..... 89
  - Kickdown**
  - Driving tips ..... 141
  - Manual drive program ..... 142
  - Knee bag** ..... 58
- L**
- Lamps**
  - see Warning and indicator lamps
  - Lane Keeping Assist**
  - Activating/deactivating ..... 199
  - Display message ..... 201
  - Function/information ..... 179
  - see Active Lane Keeping Assist
  - Lap time (RACETIMER)** ..... 199
  - LATCH-type (ISOFIX) child seat anchors** ..... 69
  - Level control (display message)** ..... 201
  - Level control (vehicles with AIR-MATIC package)**
  - Basic settings ..... 167
  - Function/notes ..... 165
  - Important safety notes ..... 165
  - Level control (vehicles with the ON&OFFROAD package)**
  - Basic settings ..... 163
  - Function/notes ..... 162
  - Important safety notes ..... 162
  - License plate lamp**
  - Display message ..... 201
  - License plate lamp (display message)** ..... 201
  - Light function, active**
  - Display message ..... 201
  - Light sensor (display message)** ..... 201
  - Lights**
  - Activating/deactivating the interior lighting delayed switch-off ..... 199
  - Adaptive Highbeam Assist ..... 115
  - Cornering light function ..... 115
  - Hazard warning lamps ..... 114
  - High beam flasher ..... 115
  - High-beam headlamps ..... 115
  - Light switch ..... 114
  - Setting the brightness of the ambient lighting (on-board computer) ..... 199
  - Setting the color of the ambient lighting (on-board computer) ..... 199
  - Switching the daytime running lamps on/off (on-board computer) ..... 199
  - Switching the exterior lighting delayed switch-off on/off (on-board computer) ..... 199
  - Switching the surround lighting on/off (on-board computer) ..... 199
  - Turn signals ..... 115
  - see Replacing bulbs
  - List of access data**
  - New provider ..... 241
  - List of mobile phone network providers**
  - Empty ..... 239
  - With the selected provider ..... 240
  - Loading guidelines** ..... 248

- Locking**  
 see Central locking
- Locking (doors)**  
 Automatic ..... 95  
 Emergency locking ..... 96  
 From inside (central locking button) ..... 95
- Locking centrally**  
 see Central locking
- Locking verification signal (on-board computer)** ..... 199
- LOW RANGE**  
 Display message ..... 201  
 Off-road gear ..... 188
- LOW RANGE off-road gear** ..... 188
- Low-beam headlamps**  
 Changing bulbs ..... 118  
 Display message ..... 201
- M**
- M+S tires** ..... 294
- Malfunction message**  
 see Display messages
- Matte finish (cleaning instructions)** ..... 272
- mbrace**  
 Call priority ..... 260  
 Display message ..... 201  
 Downloading destinations (COMAND) ..... 256  
 Downloading routes ..... 256  
 Emergency call ..... 257  
 General notes ..... 256  
 Geo fencing ..... 256  
 Locating a stolen vehicle ..... 256  
 MB info call button ..... 259  
 Remote vehicle locking ..... 256  
 Roadside Assistance button ..... 258  
 Search & Send ..... 256  
 Self-test ..... 257  
 Speed alert ..... 256  
 System ..... 256  
 Triggering the vehicle alarm ..... 256  
 Vehicle remote malfunction diagnosis ..... 256  
 Vehicle remote unlocking ..... 256
- Mechanical key**  
 Function/notes ..... 90  
 Inserting ..... 90  
 Locking vehicle ..... 96  
 Removing ..... 90  
 Unlocking the driver's door ..... 95
- Memory card (audio)** ..... 199
- Memory function** ..... 112
- Mercedes-Benz Intelligent Drive**  
 Active Blind Spot Assist ..... 180  
 Active Parking Assist ..... 169  
 Blind Spot Assist ..... 177  
 DISTRONIC PLUS ..... 156  
 General notes ..... 155  
 Lane Keeping Assist ..... 179  
 PARKTRONIC ..... 168
- Message memory (on-board computer)** ..... 201
- Mirrors**  
 see Exterior mirrors  
 see Rear-view mirror  
 see Vanity mirror (in the sun visor)
- Mobile phone**  
 Frequencies ..... 330  
 Installation ..... 330  
 Menu (on-board computer) ..... 199  
 Transmission output (maximum) .... 330
- Mobile phone network providers**  
 Calling up ..... 239
- Modifying the programming (SmartKey)** ..... 90
- MOExtended tires** ..... 275
- Mounting wheels**  
 Lowering the vehicle ..... 318  
 Mounting a new wheel ..... 318  
 Preparing the vehicle ..... 315  
 Raising the vehicle ..... 316  
 Removing a wheel ..... 317  
 Securing the vehicle against rolling away ..... 315
- MP3**  
 Operation ..... 199  
 see also Digital Operator's Manual ..... 228  
 see separate operating instructions
- Multicontour seat** ..... 110

**Multifunction display**

- Function/notes ..... 198
- Permanent display ..... 199

**Multifunction steering wheel**

- Operating the on-board computer ..... 198
- Overview ..... 43

**Music files**

- see also Digital Operator's Manual ..... 228

**N****Navigation**

- Menu (on-board computer) ..... 199
- see also Digital Operator's Manual ..... 228
- see separate operating instructions

**Night View Assist Plus**

- Activating/deactivating ..... 175
- Cleaning ..... 272
- Problem (malfunction) ..... 177

**Notes on breaking-in a new vehicle**

- ..... 134

**O****Occupant Classification System (OCS)**

- Conditions ..... 59
- Faults ..... 63
- Operation ..... 60
- System self-test ..... 62

**Occupant safety**

- Automatic measures after an accident ..... 66
- Children in the vehicle ..... 67
- Important safety notes ..... 51
- Introduction to the restraint system ..... 50
- Occupant Classification System (OCS) ..... 59
- PASSENGER AIR BAG indicator lamps ..... 51
- Pets in the vehicle ..... 73
- PRE-SAFE® (anticipatory occupant protection) ..... 66
- Restraint system warning lamp ..... 51

**OCS**

- Conditions ..... 59
- Faults ..... 63
- Operation ..... 60
- System self-test ..... 62

**Odometer**

- ..... 199

**Off-road driving**

- Approach/departure angle ..... 342
- Checklist after driving off-road ..... 153
- Checklist before driving off-road ... 153
- Fording depth ..... 341
- General information ..... 153
- Important safety notes ..... 152
- Maximum gradient climbing ability ..... 343
- Traveling uphill ..... 154

**Off-road programs (vehicles with the ON&OFFROAD package)**

- Displays in the COMAND display ... 189
- Function/notes ..... 188
- Off-road program 1 ..... 188
- Off-road program 2 ..... 188

**Off-road system**

- 4MATIC ..... 186
- DSR ..... 187
- LOW RANGE off-road gear ..... 188
- Off-road 4ETS ..... 79
- Off-road ABS ..... 75
- Off-road ESP® ..... 81
- Off-road programs (vehicles with the ON&OFFROAD package) ..... 188

**Oil**

- see Engine oil

**On and Offroad menu (on-board computer)**

- ..... 199

**On-board computer**

- AMG menu ..... 199
- Assistance menu ..... 199
- Audio menu ..... 199
- Convenience submenu ..... 199
- Display messages ..... 201
- Displaying a service message ..... 270
- DISTRONIC PLUS ..... 160
- Factory settings submenu ..... 199
- Important safety notes ..... 198
- Instrument cluster submenu ..... 199
- Lighting submenu ..... 199
- Menu overview ..... 199

- Message memory ..... 201
- Message memory menu ..... 201
- Navigation menu ..... 199
- On and Offroad menu ..... 199
- Operation ..... 198
- RACETIMER ..... 199
- Service menu ..... 199
- Settings menu ..... 199
- Standard display ..... 199
- Telephone menu ..... 199
- Trip menu ..... 199
- Vehicle submenu ..... 199
- Video DVD operation ..... 199
- On-road programs**
- AUTO program ..... 186
- Function/notes ..... 185
- Snow program ..... 186
- SPORT program ..... 186
- Trailer program ..... 186
- Online and Internet functions**
- Ending the connection ..... 243
- Establishing/ending the connection ..... 242
- Manually setting the access data of the mobile phone network provider ..... 241
- Selecting the access data of the mobile phone network provider ..... 240
- Opening and closing the side trim panels** ..... 119
- Operating safety**
- Declaration of conformity ..... 34
- Important safety notes ..... 33
- Operating system**
- see On-board computer
- Operator's Manual**
- Vehicle equipment ..... 31
- Outside temperature display** ..... 198
- Overhead control panel** ..... 47
- Override feature**
- Rear side windows ..... 73
- Panorama roof with power tilt/sliding panel**
- Important safety notes ..... 102
- Opening/closing ..... 104
- Opening/closing the roller sun-blind ..... 105
- Problem (malfunction) ..... 106
- Resetting ..... 105
- Parking**
- Important safety notes ..... 148
- Parking brake ..... 149
- Position of exterior mirror, front-passenger side ..... 112
- Rear view camera ..... 170
- see PARKTRONIC
- Parking aid**
- Active Parking Assist ..... 169
- see Exterior mirrors
- see PARKTRONIC
- Parking assistance**
- see PARKTRONIC
- Parking brake**
- Display message ..... 201
- Electric parking brake ..... 149
- Warning lamp ..... 214
- PARKTRONIC**
- Deactivating/activating ..... 169
- Driving system ..... 168
- Function/notes ..... 168
- Important safety notes ..... 168
- Problem (malfunction) ..... 169
- Range of the sensors ..... 168
- Trailer towing ..... 169
- Warning display ..... 169
- PASSENGER AIR BAG**
- Display message ..... 207
- Problems (malfunction) ..... 207
- PASSENGER AIR BAG OFF**
- Indicator lamp ..... 51
- Pets in the vehicle** ..... 73
- Phone book**
- see also Digital Operator's Manual ..... 228
- Plastic trim (cleaning instructions)** ..... 272
- Power closing feature** ..... 95
- Power washers** ..... 272

## P

- Paint code number** ..... 332
- Paintwork (cleaning instructions)** ... 272
- Panic alarm** ..... 50



- Power windows**
    - see Side windows
  - PRE-SAFE® (anticipatory occupant protection)**
    - Display message ..... 201
    - Operation ..... 66
  - PRE-SAFE® Brake**
    - Activating/deactivating ..... 199
    - Display message ..... 201
    - Function/notes ..... 82
    - Important safety notes ..... 82
    - Warning lamp ..... 224
  - Program selector button** ..... 141
  - Protection against theft**
    - ATA (Anti-Theft Alarm system) ..... 84
    - Immobilizer ..... 84
  - Protection of the environment**
    - General notes ..... 30
  - Pulling away**
    - General notes ..... 138
    - Trailer ..... 138
  - Pulling away (automatic transmission)** ..... 138
- Q**
- QR code**
    - Mercedes-Benz Guide App ..... 1
    - Rescue card ..... 36
  - Qualified specialist workshop** ..... 35
- R**
- RACETIMER (on-board computer)** .... 199
  - Radiator cover** ..... 267
  - Radio**
    - Selecting a station ..... 199
    - see separate operating instructions
  - Radio mode**
    - see also Digital Operator's Manual ..... 228
  - Radio-controlled devices (installing)** ..... 255
  - Radio-wave reception/transmission in the vehicle**
    - Declaration of conformity ..... 34
  - Reading lamp** ..... 116
  - Rear bench seat**
    - Folding forwards/back ..... 251
  - Rear seats**
    - Adjusting ..... 110
    - Display message ..... 201
  - Rear view camera**
    - Cleaning instructions ..... 272
    - Displays in the Audio display ..... 172
    - Displays in the COMAND display ... 172
    - Function/notes ..... 170
    - Switching on/off ..... 171
  - Rear window defroster**
    - Problem (malfunction) ..... 131
    - Switching on/off ..... 131
  - Rear window wiper**
    - Replacing the wiper blade ..... 121
    - Switching on/off ..... 120
  - Rear-view mirror**
    - Anti-glare (manual) ..... 112
    - Dipping (automatic) ..... 112
  - Refrigerant (air-conditioning system)**
    - Important safety notes ..... 339
  - Refueling**
    - Fuel gauge ..... 41, 198
    - Important safety notes ..... 142
    - Refueling process ..... 143
    - see Fuel
  - Remote control**
    - Garage door opener ..... 260
    - Programming (garage door opener) ..... 261
  - Replacing bulbs**
    - Important safety notes ..... 116
    - Overview of bulb types ..... 117
    - Removing/replacing the cover (front wheel arch) ..... 118
  - Reporting safety defects** ..... 35
  - Rescue card** ..... 36
  - Reserve (fuel tank)**
    - see Fuel
  - Reserve fuel**
    - Display message ..... 201
    - Warning lamp ..... 214
    - see Fuel
  - Residual heat (climate control)** ..... 131
  - Restraint system**
    - Display message ..... 205

- Introduction ..... 50
  - Warning lamp ..... 222
  - Warning lamp (function) ..... 51
  - Reversing feature**
    - Panorama sliding sunroof ..... 103
    - Roller sunblinds ..... 104
    - Side windows ..... 101
    - Sliding sunroof ..... 103
    - Tailgate ..... 97
  - Reversing lamps (display message)** ..... 201
  - Roadside Assistance (breakdown)** .... 32
  - Roller sunblind**
    - Panorama roof with power tilt/  
sliding panel ..... 104
    - Rear side windows ..... 255
  - Roof**
    - Display message ..... 201
  - Roof carrier** ..... 255
  - Roof lining and carpets (cleaning guidelines)** ..... 272
  - Roof load (maximum)** ..... 340
  - Route (navigation)**
    - see Route guidance (navigation)
  - Route guidance**
    - see also Digital Operator's Manual ..... 228
  - Route guidance (navigation)** ..... 199
- S**
- Safety**
    - Children in the vehicle ..... 67
  - Safety system**
    - see Driving safety systems
  - SD memory card**
    - see also Digital Operator's Manual ..... 228
  - Search & Send**
    - see also Digital Operator's Manual ..... 228
  - Seat belts**
    - Adjusting the driver's and front-passenger seat belt ..... 55
    - Adjusting the height ..... 54
    - Cleaning ..... 272
    - Correct usage ..... 53
    - Display message ..... 201
    - Fastening ..... 54
    - Important safety guidelines ..... 52
    - Introduction ..... 52
    - Releasing ..... 55
    - Switching belt adjustment on/off (on-board computer) ..... 199
    - Warning lamp ..... 214
    - Warning lamp (function) ..... 55
  - Seats**
    - Adjusting (electrically) ..... 110
    - Adjusting the 4-way lumbar support ..... 110
    - Adjusting the 4-way lumbar support (on seat) ..... 110
    - Adjusting the head restraint ..... 110
    - Cleaning the cover ..... 272
    - Correct driver's seat position ..... 108
    - Folding the 2nd row of seats forward electrically ..... 110
    - Folding the 2nd row of seats forward manually ..... 110
    - Folding the rear bench seat forwards/back ..... 250
    - Important safety notes ..... 109
    - Multicontour seat ..... 110
    - Seat heating problem ..... 111
    - Storing settings (memory function) ..... 112
    - Switching seat heating on/off ..... 110
    - Switching seat ventilation on/off .. 110
  - Section**
    - Sliding sunroof ..... 102
  - Sensors (cleaning instructions)** ..... 272
  - Service menu (on-board computer)** ..... 199
  - Service message**
    - see ASSYST PLUS
  - Service products**
    - Brake fluid ..... 337
    - Coolant (engine) ..... 338
    - DEF special additives ..... 336
    - Engine oil ..... 336
    - Fuel ..... 333
    - Important safety notes ..... 333
    - Refrigerant (air-conditioning system) ..... 339
    - Washer fluid ..... 339
  - Setting the air distribution** ..... 131

- Setting the airflow** ..... 131
- Setting the date/time format**
  - see also Digital Operator's Manual ..... 228
- Setting the language**
  - see also Digital Operator's Manual ..... 228
- Setting the time**
  - see also Digital Operator's Manual ..... 228
- Settings**
  - Factory (on-board computer) ..... 199
  - Menu overview ..... 232
  - On-board computer ..... 199
- SETUP (on-board computer)** ..... 199
- Side impact air bag** ..... 58
- Side marker lamp (display message)** ..... 201
- Side windows**
  - Cleaning ..... 272
  - Important safety information ..... 100, 101
  - Opening/closing (all) ..... 101
  - Opening/closing (front) ..... 101
  - Overview ..... 100
  - Problem (malfunction) ..... 102
  - Resetting ..... 101
  - Reversing feature ..... 101
- SIRIUS services**
  - see also Digital Operator's Manual ..... 228
- Sliding sunroof**
  - Important safety notes ..... 102
  - Opening/closing ..... 103
  - Problem (malfunction) ..... 106
  - Resetting ..... 104
  - see Panorama roof with power tilt/sliding panel
- SmartKey**
  - Changing the battery ..... 91
  - Changing the programming ..... 90
  - Checking the battery ..... 91
  - Display message ..... 201
  - Door central locking/unlocking ..... 88
  - Important safety notes ..... 88
  - KEYLESS-GO start function ..... 90
  - Loss ..... 93
  - Mechanical key ..... 90
  - Overview ..... 88
  - Positions (ignition lock) ..... 135
  - Problem (malfunction) ..... 93
  - Starting the engine ..... 137
- SMS**
  - see also Digital Operator's Manual ..... 228
- Snow chains**
  - Information ..... 295
  - Snow drive program ..... 186
- Sockets**
  - Center console ..... 255
  - General notes ..... 255
  - Luggage compartment ..... 255
  - Rear compartment ..... 255
- Special seat belt retractor** ..... 67
- Specialist workshop** ..... 35
- Speed, controlling**
  - see Cruise control
- Speedometer**
  - Digital ..... 199
  - In the Instrument cluster ..... 41, 198
  - Segments ..... 198
  - Selecting the display unit ..... 199
  - see Instrument cluster
- Standing lamps**
  - Display message ..... 201
- Start/stop function**
  - see ECO start/stop function
- Starting (engine)** ..... 137
- STEER CONTROL** ..... 83
- Steering (display message)** ..... 213
- Steering assistant STEER CONTROL**
  - see STEER CONTROL
- Steering wheel**
  - Adjusting (electrically) ..... 111
  - Adjusting (manually) ..... 111
  - Button overview ..... 43
  - Buttons (on-board computer) ..... 198
  - Important safety notes ..... 111
  - Paddle shifters ..... 141
  - Steering wheel heating ..... 111
  - Storing settings (memory function) ..... 112

- Steering wheel (cleaning instructions)** ..... 272
- Steering wheel heating**  
Switching on/off ..... 111
- Steering wheel paddle shifters** ..... 141
- Stopwatch (RACETIMER)** ..... 199
- Stowage areas** ..... 248
- Stowage compartments**  
Armrest (under) ..... 249  
Center console ..... 249  
Center console (rear) ..... 249  
Cup holders ..... 255  
Display message ..... 201  
Eyeglasses compartment ..... 249  
Glove box ..... 249  
Important safety information ..... 249  
Stowage net ..... 249
- Stowage net** ..... 249
- Summer tires** ..... 294
- Sun visor** ..... 255
- Surround lighting (on-board computer)** ..... 199
- Suspension tuning**  
AMG adaptive sport suspension system ..... 167  
SETUP (on-board computer) ..... 199
- SUV**  
(Sport Utility Vehicle) ..... 33
- Switching air-recirculation mode on/off** ..... 131
- T**
- Tachometer** ..... 198
- Tail lamps**  
Display message ..... 201
- Tailgate**  
Display message ..... 213  
Emergency unlocking ..... 100  
Important safety notes ..... 96  
Limiting the opening angle ..... 100  
Opening dimensions ..... 340  
Opening/closing (automatically from inside) ..... 99  
Opening/closing (automatically from outside) ..... 98  
Opening/closing (from outside) ..... 97  
Power closing ..... 95
- Tank**  
see Fuel tank
- Tank content**  
Fuel gauge ..... 41, 198
- Technical data**  
Capacities ..... 333  
Emergency spare wheel ..... 328  
Information ..... 330  
Tires/wheels ..... 319  
Trailer loads ..... 344  
Vehicle data ..... 340
- TELEAID**  
Call priority ..... 260  
Downloading destinations (COMAND) ..... 256  
Downloading routes ..... 256  
Emergency call ..... 257  
General notes ..... 256  
Geo fencing ..... 256  
Locating a stolen vehicle ..... 256  
MB info call button ..... 259  
Remote vehicle locking ..... 256  
Roadside Assistance button ..... 258  
Search & Send ..... 256  
Self-test ..... 257  
Speed alert ..... 256  
System ..... 256  
Triggering the vehicle alarm ..... 256  
Vehicle remote malfunction diagnosis ..... 256  
Vehicle remote unlocking ..... 256
- Telephone**  
Accepting a call ..... 199  
Display message ..... 201  
Menu (on-board computer) ..... 199  
Number from the phone book ..... 199  
Redialing ..... 199  
Rejecting/ending a call ..... 199  
see also Digital Operator's Manual ..... 228
- Temperature**  
Coolant ..... 198  
Coolant (on-board computer, Mercedes-AMG vehicles) ..... 199  
Engine oil (on-board computer, Mercedes-AMG vehicles) ..... 199  
Setting (climate control) ..... 131

- Transmission oil (on-board computer, Mercedes-AMG vehicles) ..... 199
- Through-loading feature** ..... 250
- Timing (RACETIMER)** ..... 199
- Tire pressure**
  - Calling up (on-board computer) ..... 300
  - Checking manually ..... 298
  - Display message ..... 211
  - Maximum ..... 298
  - Not reached (TIREFIT) ..... 278
  - Notes ..... 296
  - Reached (TIREFIT) ..... 278
  - Recommended ..... 295
- Tire pressure loss warning system**
  - General notes ..... 298
  - Important safety notes ..... 299
  - Restarting ..... 299
- Tire pressure monitor**
  - Checking the tire pressure electronically ..... 301
  - Function/notes ..... 300
  - General notes ..... 300
  - Important safety notes ..... 300
  - Radio type approval for the tire pressure monitor ..... 302
  - Restarting ..... 302
  - Warning lamp ..... 225
  - Warning message ..... 302
- TIREFIT kit** ..... 276
  - Tire pressure not reached ..... 278
  - Tire pressure reached ..... 278
- Tires**
  - Aspect ratio (definition) ..... 313
  - Average weight of the vehicle occupants (definition) ..... 312
  - Bar (definition) ..... 311
  - Changing a wheel ..... 314
  - Characteristics ..... 311
  - Checking ..... 293
  - Curb weight (definition) ..... 313
  - Definition of terms ..... 311
  - Direction of rotation ..... 314
  - Display message ..... 211
  - Distribution of the vehicle occupants (definition) ..... 314
  - DOT (Department of Transportation) (definition) ..... 312
  - DOT, Tire Identification Number (TIN) ..... 311
  - GAWR (Gross Axle Weight Rating) (definition) ..... 312
  - General notes ..... 319
  - GTW (Gross Trailer Weight) (definition) ..... 312
  - GVW (Gross Vehicle Weight) (definition) ..... 312
  - GVWR (Gross Vehicle Weight Rating) (definition) ..... 312
  - Important safety notes ..... 292
  - Increased vehicle weight due to optional equipment (definition) ..... 312
  - Information on driving ..... 292
  - Kilopascal (kPa) (definition) ..... 312
  - Labeling (overview) ..... 308
  - Load bearing index (definition) ..... 313
  - Load index ..... 310
  - Load index (definition) ..... 312
  - M+S tires ..... 294
  - Maximum load on a tire (definition) ..... 313
  - Maximum loaded vehicle weight (definition) ..... 312
  - Maximum permissible tire pressure (definition) ..... 313
  - Maximum tire load ..... 310
  - Maximum tire load (definition) ..... 313
  - MOExtended tires ..... 294
  - Optional equipment weight (definition) ..... 313
  - PSI (pounds per square inch) (definition) ..... 313
  - Replacing ..... 314
  - Service life ..... 294
  - Sidewall (definition) ..... 313
  - Speed rating (definition) ..... 312
  - Storing ..... 314
  - Structure and characteristics (definition) ..... 311
  - Temperature ..... 307
  - TIN (Tire Identification Number) (definition) ..... 313
  - Tire bead (definition) ..... 313
  - Tire pressure (definition) ..... 313
  - Tire pressures (recommended) ..... 312
  - Tire size (data) ..... 319

- Tire size designation, load-bearing capacity, speed rating ..... 308
- Tire tread ..... 293
- Tire tread (definition) ..... 313
- Total load limit (definition) ..... 314
- Traction ..... 307
- Traction (definition) ..... 313
- Tread wear ..... 307
- TWR (permissible trailer drawbar noseweight) (definition) ..... 313
- Uniform Tire Quality Grading Standards ..... 306
- Uniform Tire Quality Grading Standards (definition) ..... 312
- Wear indicator (definition) ..... 314
- Wheel and tire combination ..... 321
- Wheel rim (definition) ..... 312
- see Flat tire
- Tool**
- see Vehicle tool kit
- Top Tether** ..... 70
- Tow-starting**
- Emergency engine starting ..... 288
- Important safety notes ..... 285
- Towing a trailer**
- Active Parking Assist ..... 170
- Axle load, permissible ..... 344
- Cleaning the trailer tow hitch ..... 272
- Coupling up a trailer ..... 193
- Decoupling a trailer ..... 195
- Driving tips ..... 191
- ESP® (Electronic Stability Program) ..... 81
- Important safety notes ..... 190
- Installing the ball coupling ..... 192
- Lights display message ..... 201
- Mounting dimensions ..... 343
- Power supply ..... 196
- Pulling away with a trailer ..... 138
- Removing the ball coupling ..... 196
- Trailer drive program ..... 186
- Trailer loads ..... 344
- Towing away**
- Important safety guidelines ..... 285
- Installing the towing eye ..... 286
- Removing the towing eye ..... 287
- With both axles on the ground ..... 287
- Traffic reports**
- see also Digital Operator's Manual ..... 228
- Trailer**
- Display message ..... 201
- Trailer coupling**
- see Towing a trailer
- Trailer loads and drawbar noseweights** ..... 195
- Trailer towing**
- PARKTRONIC ..... 169
- Permissible trailer loads and drawbar noseweights ..... 195
- Transfer case** ..... 142
- Transmission**
- see Automatic transmission
- Transmission position display** ..... 140
- Transmission position display (DIRECT SELECT lever)** ..... 140
- Transporting the vehicle** ..... 287
- Traveling uphill**
- Brow of hill ..... 154
- Driving downhill ..... 154
- Maximum gradient-climbing capability ..... 154
- Trim pieces (cleaning instructions)** ..... 272
- Trip computer (on-board computer)** ..... 199
- Trip odometer**
- Calling up ..... 199
- Resetting (on-board computer) ..... 199
- Trunk**
- see Tailgate
- Trunk lid**
- Display message ..... 201
- Trunk partition**
- Display message ..... 201
- Turn signals**
- Display message ..... 201
- Switching on/off ..... 115
- Two-way radio**
- Frequencies ..... 330
- Installation ..... 330
- Transmission output (maximum) ..... 330
- TWR (Tongue Weight Rating) (definition)** ..... 313

**Type identification plate**

see Vehicle identification plate

**U****Unlocking**

- Emergency unlocking ..... 95
- From inside the vehicle (central unlocking button) ..... 95

**Upshift indicator (on-board computer, Mercedes-AMG vehicles) .....**

199

**V****Vanity mirror (in the sun visor) .....**

256

**Vehicle**

- Correct use ..... 35
- Data acquisition ..... 36
- Display message ..... 213
- Equipment ..... 31
- Individual settings ..... 199
- Limited Warranty ..... 36
- Loading ..... 303
- Locking (in an emergency) ..... 96
- Locking (SmartKey) ..... 88
- Lowering ..... 318
- Maintenance ..... 32
- Parking for a long period ..... 150
- Pulling away ..... 138
- Raising ..... 316
- Reporting problems ..... 35
- Securing from rolling away ..... 315
- Towing away ..... 285
- Transporting ..... 287
- Unlocking (in an emergency) ..... 95
- Unlocking (SmartKey) ..... 88
- Vehicle data ..... 340

**Vehicle battery**

see Battery (vehicle)

**Vehicle data .....**

340

**Vehicle data (off-road driving)**

- Approach/departure angle ..... 342
- Fording depth ..... 341
- Maximum gradient climbing ability ..... 343

**Vehicle dimensions .....**

340

**Vehicle emergency locking .....**

96

**Vehicle identification number**

see VIN

**Vehicle identification plate .....**

332

**Vehicle level**

- AMG adaptive sport suspension system ..... 167

**Vehicle level (display message) .....**

201

**Vehicle tool kit .....**

274

**Video**

- Operating the DVD ..... 199
- see also Digital Operator's Manual ..... 228

**Video (DVD) .....**

199

**VIN .....**

332

**Voice Control System**

see Separate operating instructions

**W****Warning and indicator lamps**

- ABS ..... 217
- Brakes ..... 216
- Check Engine ..... 214
- Coolant ..... 223
- Distance warning ..... 224
- DISTRONIC PLUS ..... 224
- ESP® ..... 220
- ESP® OFF ..... 221
- Fuel tank ..... 214
- General notes ..... 214
- Overview ..... 42
- PASSENGER AIR BAG OFF ..... 51
- Reserve fuel ..... 214
- Restraint system ..... 222
- Seat belt ..... 214
- Tire pressure monitor ..... 225

**Warranty .....**

31

**Washer fluid**

- Display message ..... 201

**Wheel and tire combinations**

- Tires ..... 321

**Wheel bolt tightening torque .....**

318

**Wheel chock .....**

315

**Wheels**

- Changing a wheel ..... 314
- Checking ..... 293
- Cleaning ..... 272
- Emergency spare wheel ..... 325

- General notes ..... 319
- Important safety notes ..... 292
- Information on driving ..... 292
- Interchanging/changing ..... 314
- Mounting a new wheel ..... 318
- Mounting a wheel ..... 315
- Overview ..... 292
- Removing a wheel ..... 317
- Storing ..... 314
- Tightening torque ..... 318
- Wheel size/tire size ..... 319
- Window curtain air bag**
  - Display message ..... 206
  - Operation ..... 59
- Windows**
  - see Side windows
- Windshield**
  - Defrosting ..... 131
  - Infrared reflective ..... 255
- Windshield washer fluid**
  - see Windshield washer system
- Windshield washer system**
  - Adding washer fluid ..... 270
  - Notes ..... 339
- Windshield wipers**
  - Problem (malfunction) ..... 122
  - Rear window wiper ..... 120
  - Replacing the wiper blades ..... 120
  - Switching on/off ..... 119
- Winter driving**
  - Slippery road surfaces ..... 151
  - Snow chains ..... 295
- Winter operation**
  - General notes ..... 294
  - Overview ..... 294
  - Radiator cover ..... 267
  - Snow drive program ..... 186
- Winter tires**
  - M+S tires ..... 294
- Wiper blades**
  - Cleaning ..... 272
  - Important safety notes ..... 120
  - Replacing ..... 120
  - Replacing (rear window) ..... 121
  - Replacing (windshield) ..... 120
- Wooden trim (cleaning instructions)** ..... 272
- Workshop**
  - see Qualified specialist workshop



## Introduction

In addition to the printed Operator's Manual, the vehicle document wallet also contains further operating instructions, such as:

- Digital Operator's Manual on CD
- Maintenance Booklet
- Equipment-dependent supplements

The printed Operator's Manual provides information on selected functions of your vehicle.

You can also access the Digital Operator's Manual via COMAND. If you have further questions that are not covered in the printed Operator's Manual, please consult the Digital Operator's Manual. The vehicle functions and functions of COMAND are described in the Digital Operator's Manual.

You can purchase a printed Operator's Manual with the same contents as the Digital Operator's Manual in an authorized Mercedes-Benz Center.

**i** You will not incur any costs when calling up the Digital Operator's Manual. It works without connecting to the Internet.

In the following sections you will find further information about:

- how to install the Digital Operator's Manual on your COMAND (▷ page 25)
- how to access and operate the Digital Operator's Manual
- various options for accessing the individual topics covered by the Digital Operator's Manual.



There are three options for accessing via the basic menu of the Digital Operator's Manual:

- Visual search
- Keyword search
- Contents

## Installation

Check whether or not the Digital Operator's Manual has already been installed. To do so,

call up the Digital Operator's Manual via COMAND as follows:

- ▶ Using the COMAND controller, select the  symbol from the menu bar in the COMAND display and press  to confirm.
- ▶ Select the "Operator's Manual" selection card and press  to confirm. There are two possibilities:
  1. The Digital Operator's Manual is installed. The basic menu for the Digital Operator's Manual opens.
  2. The Digital Operator's Manual is not installed. The following message appears: **The Operator's Manual has not yet been installed. Please insert the correct disc.**

If the Digital Operator's Manual has not yet been installed, you have the option of installing it yourself. You will find the installation CD required in the vehicle document wallet.

The duration of the installation process can vary.

The installation process takes approximately 5 minutes. This timespan only applies if you install the Digital Operator's Manual while the vehicle is at a standstill and no other COMAND functions are in use at the time. The duration of the installation process may increase accordingly if other COMAND functions such as navigation or telephony are in use at the time.

If you encounter any problems during installation, please contact an authorized Mercedes-Benz Center.

- ▶ **To install the Digital Operator's Manual:** stop the vehicle safely, paying attention to road and traffic conditions.
- ▶ Turn the SmartKey to position **2** in the ignition lock (▷ page 135).
- ▶ Switch on COMAND.
- ▶ Insert the installation CD into the CD/DVD drive.

- ▶ Select the desired language for the installation.
- ▶ Follow the installation steps on the COMAND display.
- ❗ If the check was not successful, a message appears, e.g. *The Digital Operator's Manual is not supported by the system. Ejecting Disc.* Please contact your authorized Mercedes-Benz Center.



- ▶ **When the installation has been completed:** press the COMAND controller to confirm ejection of the installation CD.
- ❗ **To cancel the installation:** you can cancel the installation of the Digital Operator's Manual during the installation process. The installation can be continued at a later date.
- To continue the installation:** insert the installation CD into the CD/DVD drive again. Follow the installation instructions as described above.

## Operation

### Calling up the Digital Operator's Manual

- ▶ Press the **ON** control knob on COMAND. COMAND switches on. The previously selected menu appears after a warning message.
- ▶ Using the COMAND controller, select the **globe** symbol in the menu bar and press **OK** to confirm.
- ▶ Choose the "Operator's Manual" page and press **OK** to confirm. The basic menu for the Digital Operator's Manual opens.

## Visual search

The visual search allows you to explore your vehicle "virtually". Starting from either the vehicle exterior view or interior view, you can access many of the different topics covered by the Operator's Manual. To access the vehicle interior section, select the "Vehicle interior" view.

If a vehicle has several body styles, you can choose between the different body styles when the visual search is started for the first time. You can change the selected body style in the basic menu under "Settings".

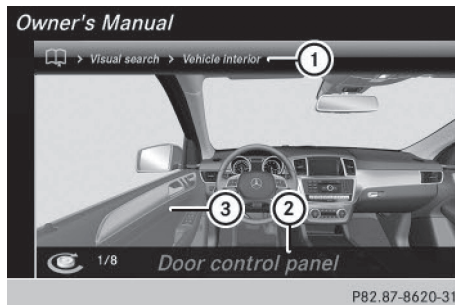

- ① Topic bar
- ② Selected section heading
- ③ Active vehicle component

- ▶ Turn **[⊙]** or slide **←⊙→** the COMAND controller to select individual vehicle components. Individual vehicle components are highlighted in color. Just one vehicle component per view is highlighted.
- ▶ To confirm the currently selected section, press **[⊙]** the COMAND controller.

After you have selected a section, one of the following happens:

- you go straight to the corresponding section in the Digital Operator's Manual.
- a list opens up with further, in-depth headings that you can select using the COMAND controller.
- you go down a level to the visual search. You can refine your search here. Turn **[⊙]** or slide **←⊙→** the COMAND controller to select individual vehicle components highlighted in red **③**.
- ▶ **To access the previous view/the previous section:** press the **[←]** back button next to the COMAND controller. The previous view or previous section opens.

- i** If you are in the vehicle exterior view and you press the **[←]** back button, you will exit the visual search. The basic menu for the Digital Operator's Manual opens.

### Keyword search

The keyword search allows you to perform a keyword search using character entry. A detailed description of character entry can be found in the "COMAND" section under the keyword "Character entry (navigation)".

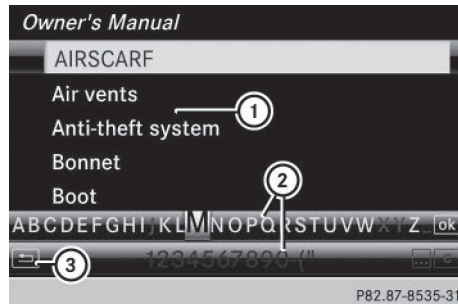

- ① Selection list of available keywords
- ② Character bar
- ③ **[←]** Back symbol

- ▶ **To enter a keyword:** turn **[⊙]** or slide **←⊙→** the COMAND controller to select a character. Slide **↑⊙↓** the COMAND controller to change the character bar.

- i** If you are in the upper character bar, you can access the selection list by sliding **↑⊙** the COMAND controller up.

- ▶ To confirm the character, press **[⊙]** the COMAND controller. Selection list **①** is then filtered.
- ▶ Select characters in the same way until COMAND jumps automatically to selection list **①**. Alternatively, you can call up selection list **①** by pressing **OK**.

- ▶ **To access the previous selection list:** slide **←⊙** the COMAND controller to the left. Press the **[←]** back symbol to open the previous selection list.





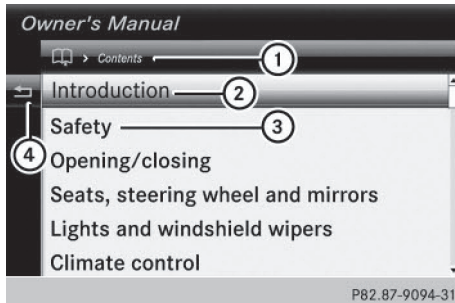

or

- ▶ Press the **[←]** back button next to the COMAND controller. The previous selection list opens.
- i** If you are in the character bar and you press the **[←]** back button, you will exit the keyword search. The basic menu for the Digital Operator's Manual opens.



## Contents

In the contents, the topics are listed in the same order as in the printed Operator's Manual. You can select a section and then a subsection.





- ① Topic bar
  - ② Currently selected section in the contents
  - ③ Section not currently selected in the contents
  - ④  Back symbol
- ▶ Turn  or slide  the COMAND controller to select the desired section.
  - ▶ To confirm the selection, press  the COMAND controller.  
A further selection list with the corresponding subsection opens.
  - ▶ Select the corresponding subsection in the same way.
  - ▶ **To access the previous selection list:** slide  the COMAND controller to the left.  
Press the  back symbol to open the previous selection list.



or

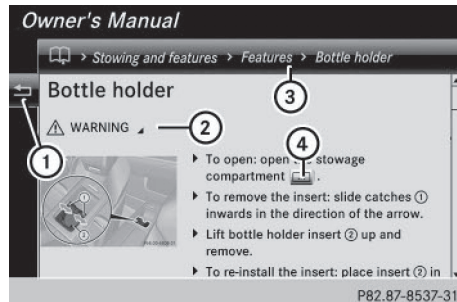

- ▶ Press the  back button next to the COMAND controller.  
The previous selection list opens.
- i** If you are on the uppermost level in the list of contents, press the  back button. You will then exit the list of contents and the basic menu for the Digital Operator's Manual opens.

## Content pages



- ①  Back symbol
- ② Hidden warning
- ③ Topic bar
- ④ Link to a continuing chapter



▶ **To navigate within a contents page:** turn  or slide  the COMAND controller to scroll the text up and down.

▶ **To navigate away from the contents page:** slide  the COMAND controller to the left.  
Press the  back symbol to open the previous page.



or

▶ Press the  back button next to the COMAND controller.











or

▶ Turn  or slide  the COMAND controller up to scroll to the very top of the contents page.

▶ Slide  the COMAND controller up again to select topic bar ③.

▶ Turn  or slide  the COMAND controller to select the desired section or subsection. To confirm the selection, press  the COMAND controller.  
The selected topic bar opens including all the subsections.

▶ **To select a link ④:** links are automatically highlighted when you scroll in a text. When you have selected a link, press  the COMAND controller.  
The desired contents page opens.

- ▶ **To open up warning notes, environmental notes and malfunction information:**  
when scrolling through the text, the cursor jumps automatically to the drop down warnings, environmental information and malfunction information. When you have selected the note, press  the COMAND controller.  
The warning note, environmental note or malfunction information opens up on the same page.
  - ▶ **To navigate away from the Digital Operator's Manual:** press and hold the  back button next to the COMAND controller.  
A window opens and you are asked if you would like to exit the browser.
  - ▶ Confirm with "Yes".  
The overview of COMAND functions opens.
  - ▶ **To switch functions from the Digital Operator's Manual to COMAND using the COMAND function buttons:** press the , , ,  or  button on COMAND.  
The desired menu opens.
  - ▶ **To go back to the Digital Operator's Manual:** use the COMAND controller to select the  symbol in the menu bar and press  to confirm.  
The last page called up in the Digital Operator's Manual is opened.
-  For safety reasons, the "Digital Operator's Manual" function is switched off while you are driving.

## Protection of the environment

### General notes

#### 🌱 Environmental note

Daimler's declared policy is one of comprehensive environmental protection.

The objectives are for the natural resources that form the basis of our existence on this planet to be used sparingly and in a manner that takes the requirements of both nature and humanity into account.

You too can help to protect the environment by operating your vehicle in an environmentally responsible manner.

Fuel consumption and the rate of engine, transmission, brake and tire wear are affected by these factors:

- operating conditions of your vehicle
- your personal driving style

You can influence both factors. You should bear the following in mind:

Operating conditions:

- avoid short trips as these increase fuel consumption.
- always make sure that the tire pressures are correct.
- do not carry any unnecessary weight.
- remove roof racks once you no longer need them.
- a regularly serviced vehicle will contribute to environmental protection. You should therefore adhere to the service intervals.
- always have service work carried out at a qualified specialist workshop.

Personal driving style:

- do not depress the accelerator pedal when starting the engine.
- do not warm up the engine when the vehicle is stationary.
- drive carefully and maintain a safe distance from the vehicle in front.
- avoid frequent, sudden acceleration and braking.

- change gear in good time and use each gear only up to  $\frac{2}{3}$  of its maximum engine speed.
- switch off the engine in stationary traffic.
- keep an eye on the vehicle's fuel consumption.

### Environmental concerns and recommendations

Wherever the operating instructions require you to dispose of materials, first try to regenerate or re-use them. Observe the relevant environmental rules and regulations when disposing of materials. In this way you will help to protect the environment.

### Genuine Mercedes-Benz parts

#### 🌱 Environmental note

Daimler AG also supplies reconditioned major assemblies and parts which are of the same quality as new parts. They are covered by the same Limited Warranty entitlements as new parts.

❗ Air bags and Emergency Tensioning Devices, as well as control units and sensors for these restraint systems, may be installed in the following areas of your vehicle:

- doors
- door pillars
- door sills
- seats
- cockpit
- instrument cluster
- center console

Do not install accessories such as audio systems in these areas. Do not carry out repairs or welding. You could impair the operating efficiency of the restraint systems.

Have aftermarket accessories installed at a qualified specialist workshop.

You could jeopardize the operating safety of your vehicle if you use parts, tires and wheels as well as accessories relevant to safety which have not been approved by Mercedes. This could lead to malfunctions in safety-relevant systems, e.g. the brake system. Use only genuine Mercedes-Benz parts or parts of equal quality. Only use tires, wheels and accessories that have been specifically approved for your vehicle.

Genuine Mercedes-Benz parts are subject to strict quality control. Every part has been specifically developed, manufactured or selected for and adapted to Mercedes-Benz vehicles. Only genuine Mercedes-Benz parts should therefore be used.

More than 300,000 different genuine Mercedes-Benz parts are available for Mercedes-Benz models.

All authorized Mercedes-Benz Centers maintain a supply of genuine Mercedes-Benz parts for necessary service and repair work. In addition, strategically located parts delivery centers provide quick and reliable parts service.

Always specify the vehicle identification number (VIN) when ordering genuine Mercedes-Benz parts (> page 332).

## Operator's Manual

### Vehicle equipment

This Operator's Manual describes all models and all standard and optional equipment of your vehicle available at the time of going to print. Country-specific differences are possible. Bear in mind that your vehicle may not feature all functions described here. This also applies to safety-relevant systems and functions. The equipment in your vehicle may therefore differ from that shown in the descriptions and illustrations.

The original purchase agreement lists all systems installed in your vehicle.

Should you have any questions concerning equipment and operation, please consult an authorized Mercedes-Benz Center.

The Operator's Manual and Maintenance Booklet are important documents and should be kept in the vehicle.

## Service and vehicle operation

### Warranty

The implied warranty for your vehicle applies in accordance with the warranty terms and conditions in the Service and Warranty Information booklet.

Your authorized Mercedes-Benz Center will replace and repair all factory-installed parts in accordance with the following warranty terms and conditions:

- New Vehicle Limited Warranty
- Emission System Warranty
- Emission Performance Warranty
- California, Connecticut, Maine, Massachusetts, New York, Pennsylvania, Rhode Island and Vermont Emission Control System Warranty
- State warranty enforcement laws (lemon laws)

Replacement parts and accessories are covered by the Mercedes-Benz Parts and Accessories warranties. These are available at any authorized Mercedes-Benz Center.

- i** Should you lose your Service and Warranty Information booklet, have an authorized Mercedes-Benz Center arrange for a replacement. The new Service and Warranty Information booklet will be posted to you.



### Information for customers in California

Under California law you may be entitled to a replacement of your vehicle or a refund of the purchase price or lease price, if after a reasonable number of repair attempts Mercedes-Benz USA, LLC and/or its authorized repair or service facilities fail to fix one or more substantial defects or malfunctions in the vehicle that are covered by its express warranty. During the period of 18 months from original delivery of the vehicle or the accumulation of 18,000 miles (approximately 29,000 km) on the odometer of the vehicle, whichever occurs first, a reasonable number of repair attempts is presumed for a retail buyer or lessee if one or more of the following occurs:

- (1) the same substantial defect or malfunction results in a condition that is likely to cause death or serious bodily injury if the vehicle is driven, that defect or malfunction has been subject to repair two or more times, and you have directly notified Mercedes-Benz USA, LLC in writing of the need for its repair,
- (2) the same substantial defect or malfunction of a less serious nature than category (1) has been subject to repair four or more times and you have directly notified us in writing of the need for its repair, or
- (3) the vehicle is out of service by reason of repair of the same or different substantial defects or malfunctions for a cumulative total of more than 30 calendar days.

Please send your written notice to:  
 Mercedes-Benz USA, LLC  
 Customer Assistance Center  
 One Mercedes Drive  
 Montvale, NJ 07645-0350

### Maintenance

The Service and Warranty Booklet describes all the necessary maintenance work which should be done at regular intervals.

Always have the Service and Warranty Booklet with you when you bring the vehicle to an authorized Mercedes-Benz Center. The service advisor will record every service for you in the Service and Warranty Booklet.

### Breakdown assistance

The Mercedes-Benz Roadside Assistance Program offers technical help in the event of a breakdown. Calls to the toll-free Roadside Assistance Hotline are answered by our agents 24 hours a day, 365 days a year.

**1-800-FOR-MERCEdes(1-800-367-6372) (USA)**

**1-800-387-0100 (Canada)**

For additional information, refer to the Mercedes-Benz Roadside Assistance Program brochure (USA) or the "Roadside Assistance" section in the Service and Warranty booklet (Canada). You will find both in your vehicle literature portfolio.

### Change of address or change of ownership

In the event of a change of address, please send us the "Notification of Address Change" in the Service and Guarantee booklet or simply call the Mercedes-Benz Customer Assistance Center (USA) at the hotline number 1-800-FOR-MERCEdes(1-800-367-6372) or Customer Service Center (Canada) at 1-800-387-0100. This will assist us in contacting you in a timely manner should the need arise.

If you sell your Mercedes, please leave the entire literature in the vehicle so that it is available to the next owner.

If you have purchased a used car, please send us the "Notification of Used Car Purchase" in



the Service and Guarantee booklet or simply call the Mercedes-Benz Customer Assistance Center (USA) at the hotline number 1-800-FOR-MERCEdes(1-800-367-6372) or Customer Service (Canada) at 1-800-387-0100.

### Vehicle operation outside the USA and Canada

If you plan to operate your vehicle in foreign countries, please be aware that:

- service facilities or replacement parts may not be readily available.
- unleaded fuel for vehicles with a catalytic converter may not be available. Leaded fuel may cause damage to the catalytic converter.
- the fuel may have a considerably lower octane rating. Unsuitable fuel can cause engine damage.

Some Mercedes-Benz models are available for delivery in Europe through our European Delivery Program. For details, consult an authorized Mercedes-Benz Center or write to one of the following addresses.

#### In the USA

Mercedes-Benz USA, LLC  
European Delivery Department  
One Mercedes Drive  
Montvale, NJ 07645-0350

#### In Canada

Mercedes-Benz Canada, Inc.  
European Delivery Department  
98 Vanderhoof Avenue  
Toronto, Ontario M4G 4C9

### Sports Utility Vehicle

#### WARNING

Due to the high center of gravity, the vehicle may start to skid and roll over in the event of an abrupt steering maneuver and/or when

the vehicle's speed is not adapted to the road conditions. There is a risk of an accident.

Always adapt your speed and driving style to the vehicle's driving characteristics and to the prevailing road and weather conditions.

Utility vehicles have a significantly higher roll-over rate than other types of vehicles.

Failure to operate this vehicle safely may result in an accident, rollover of the vehicle, and severe or fatal injury.

In a rollover crash, an unbelted person is significantly more likely to die than a person wearing a seat belt.

You and all vehicle occupants should always wear your seat belts.

### Operating safety

#### Important safety notes

#### WARNING

If you do not have the prescribed service/maintenance work or any required repairs carried out, this can result in malfunctions or system failures. There is a risk of an accident. Always have the prescribed service/maintenance work as well as any required repairs carried out at a qualified specialist workshop.

#### WARNING

Flammable material such as leaves, grass or twigs may ignite if they come into contact with hot parts of the exhaust system. There is a risk of fire.

When driving off road or on unpaved roads, check the vehicle's underside regularly. In particular, remove parts of plants or other flammable materials which have become trapped. In the case of damage, contact a qualified specialist workshop.

#### WARNING

Modifications to electronic components, their software as well as wiring can impair their function and/or the function of other net-

worked components. In particular, systems relevant to safety could also be affected. As a result, these may no longer function as intended and/or jeopardize the operating safety of the vehicle. There is an increased risk of an accident and injury.

Never tamper with the wiring as well as electronic components or their software. You should have all work to electrical and electronic equipment carried out at a qualified specialist workshop.

**!** There is a risk of damage to the vehicle if:

- the vehicle becomes stuck, e.g. on a high curb or an unpaved road
- you drive too fast over an obstacle, e.g. a curb or a hole in the road
- a heavy object strikes the undercarriage or parts of the chassis

In situations like this, the body, the undercarriage, chassis parts, wheels or tires could be damaged without the damage being visible. Components damaged in this way can unexpectedly fail or, in the case of an accident, no longer withstand the strain they are designed to.

If the underbody paneling is damaged, combustible materials such as leaves, grass or twigs can gather between the underbody and the underbody paneling. If these materials come in contact with hot parts of the exhaust system, they can catch fire.

In such situations, have the vehicle checked and repaired immediately at a qualified specialist workshop. If on continuing your journey you notice that driving safety is impaired, pull over and stop the vehicle immediately, paying attention to road and traffic conditions. In such cases, consult a qualified specialist workshop.

## Declarations of conformity

### Vehicle components which receive and/or transmit radio waves

**USA:** "The wireless devices of this vehicle comply with Part 15 of the FCC Rules. Operation is subject to the following two conditions: 1) These devices may not cause harmful interference, and 2) These devices must accept any interference received, including interference that may cause undesired operation. Changes or modifications not expressly approved by the party responsible for compliance could void the user's authority to operate the equipment."

**Canada:** "The wireless devices of this vehicle comply with Industry Canada license-exempt RSS standard(s). Operation is subject to the following two conditions: (1) These devices may not cause interference, and (2) These devices must accept any interference, including interference that may cause undesired operation of the device."

## Diagnostics connection

The diagnostics connection is only intended for the connection of diagnostic equipment at a qualified specialist workshop.

### WARNING

If you connect equipment to the diagnostics connection in the vehicle, it may affect the operation of the vehicle systems. As a result, the operating safety of the vehicle could be affected. There is a risk of an accident.

Do not connect any equipment to a diagnostics connection in the vehicle.

### WARNING

Objects in the driver's footwell can restrict the pedal travel or obstruct a depressed pedal. The operating and road safety of the vehicle is jeopardized. There is a risk of an accident.

Make sure that all objects in the vehicle are stowed correctly, and that they cannot enter

the driver's footwell. Install the floor mats securely and as specified in order to ensure sufficient clearance for the pedals. Do not use loose floor mats and do not place floor mats on top of one another.

**!** If the engine is switched off and equipment on the diagnostics connection is used, the starter battery may discharge.

Connecting equipment to the diagnostics connection can lead to emissions monitoring information being reset, for example. This may lead to the vehicle failing to meet the requirements of the next emissions test during the main inspection.

### Qualified specialist workshop

An authorized Mercedes-Benz Center is a qualified specialist workshop. It has the necessary specialist knowledge, tools and qualifications to correctly carry out the work required on your vehicle. This is especially the case for work relevant to safety.

Observe the notes in the Maintenance Booklet.

Always have the following work carried out at an authorized Mercedes-Benz Center:

- work relevant to safety
- service and maintenance work
- repair work
- alterations, installation work and modifications
- work on electronic components

### Correct use

If you remove any warning stickers, you or others could fail to recognize certain dangers. Leave warning stickers in position.

Observe the following information when driving your vehicle:

- the safety notes in this manual
- the vehicle technical data

- traffic rules and regulations
- laws and safety standards pertaining to motor vehicles

### Problems with your vehicle

If you should experience a problem with your vehicle, particularly one that you believe may affect its safe operation, we urge you to contact an authorized Mercedes-Benz Center immediately to have the problem diagnosed and rectified. If the problem is not resolved to your satisfaction, please discuss the problem again with a Mercedes-Benz Center or contact us at one of the following addresses.

#### In the USA

Customer Assistance Center  
Mercedes-Benz USA, LLC  
One Mercedes Drive  
Montvale, NJ 07645-0350

#### In Canada

Customer Relations Department  
Mercedes-Benz Canada, Inc.  
98 Vanderhoof Avenue  
Toronto, Ontario M4G 4C9

### Reporting safety defects

USA only:

The following text is published as required of manufacturers under Title 49, Code of U.S. Federal Regulations, Part 575 pursuant to the "National Traffic and Motor Vehicle Safety Act of 1966".

If you believe that your vehicle has a defect which could cause a crash or could cause injury or death, you should immediately inform the National Highway Traffic Safety Administration (NHTSA) in addition to notifying Mercedes-Benz USA, LLC.

If NHTSA receives similar complaints, it may open an investigation, and if it finds that a safety defect exists in a group of vehicles, it may order a recall and remedy campaign.

However, NHTSA cannot become involved in individual problems between you, your dealer, or Mercedes-Benz USA, LLC.

To contact NHTSA, you may call the Vehicle Safety Hotline toll-free at 1-888-327-4236 (TTY: 1-800-424-9153); go to <http://www.safercar.gov>; or write to: Administrator, NHTSA, 400 Seventh Street, SW., Washington, DC 20590.

You can also obtain other information about motor vehicle safety from

<http://www.safercar.gov>

### Limited Warranty

- ❗ Follow the instructions in this manual about the proper operation of your vehicle as well as about possible vehicle damage. Damage to your vehicle that arises from culpable contraventions against these instructions is not covered either by the Mercedes-Benz Limited Warranty or by the New or Used-Vehicle Warranty.

### QR codes for the rescue card

The QR codes are secured in the fuel filler flap and on the opposite side on the B-pillar. In the event of an accident, rescue services can use the QR code to quickly find the appropriate rescue card for your vehicle. The current rescue card contains the most important information about your vehicle in a compact form, e.g. the routing of the electric cables.

You can find more information under [http://portal.aftersales.i.daimler.com/public/content/asportal/en/communication/informationen\\_fuer/QRCode.html](http://portal.aftersales.i.daimler.com/public/content/asportal/en/communication/informationen_fuer/QRCode.html).

### Data stored in the vehicle

#### Data recording

This vehicle is capable of recording diagnostic information relating to vehicle operation, mal-

functions, and user settings. This may include information about the performance or status of various systems, including but not limited to, engine, throttle, steering or brake systems, that is stored and can be read out with suitable devices, particularly when the vehicle is serviced. The data obtained is used to properly diagnose and service your vehicle or to further optimize and develop vehicle functions.

### COMAND/mbrace (Canada: TELEAID)

If the vehicle is equipped with COMAND or mbrace, additional data about the vehicle's operation, the use of the vehicle in certain situations, and the location of the vehicle may be compiled through COMAND or the mbrace system.

For additional information please refer to the COMAND User Manual and/or the mbrace Terms and Conditions.

### Event data recorders

This vehicle is equipped with an event data recorder (EDR). The main purpose of an EDR is to record data that will assist in understanding how a vehicle's systems performed in certain crash or near crash-like situations, such as during air bag deployment or when hitting a road obstacle. The EDR is designed to record data related to vehicle dynamics and safety systems for a short period of time, typically 30 seconds or less.

The EDR in this vehicle is designed to record such data as:

- how various systems in your vehicle are operating
- whether or not the driver and passenger seat belts are fastened
- how far (if at all) the driver is depressing the accelerator and/or brake pedal and
- how fast the vehicle is traveling

This data can help provide a better understanding of the circumstances in which crashes and injuries occur. NOTE: EDR data is recorded by your vehicle only if a non-trivial crash situation occurs; no data is recorded by the EDR under normal driving conditions and no personal data (e.g., name, gender, age, and crash location) are recorded. However, other parties, such as law enforcement, can combine the EDR data with the type of personal identification data routinely acquired during a crash investigation.

To read data recorded by an EDR, special equipment is required, and access to the vehicle or the EDR is needed. In addition to the vehicle manufacturer, other parties that have the special equipment, such as law enforcement, can read the information by accessing the vehicle or the EDR.

EDR data may be used in civil and criminal matters as a tool in accident reconstruction, accident claims, and vehicle safety. Since the Crash Data Retrieval CDR tool that is used to extract data from the EDR is commercially available, Mercedes-Benz USA, LLC ("MBUSA") expressly disclaims any and all liability arising from the extraction of this information by unauthorized Mercedes-Benz personnel.

MBUSA will not share EDR data with others without the consent of the vehicle owners or, if the vehicle is leased, without the consent of the lessee. Exceptions to this representation include responses to subpoenas by law enforcement; by federal, state or local government; in connection with or arising out of litigation involving MBUSA or its subsidiaries and affiliates; or, as required by law.

Warning: The EDR is a component of the Restraint System Module. Tampering with, altering, modifying or removing the EDR component may result in a malfunction of the Restraint System Module and other systems. State laws or regulations regarding EDRs that conflict with federal regulation are pre-empted. This means that in the event of such conflict, the federal regulation governs. As of

February 2013, 13 states have enacted laws relating to EDRs.

### Information on copyright

### General information

Information on license for free and open-source software used in your vehicle and its electronic components is available on the following website:

<http://www.mercedes-benz.com/opensource>



Cockpit .....	40
Instrument cluster .....	41
Multifunction steering wheel .....	43
Center console .....	44
Overhead control panel .....	47
Door control panel .....	48



## Cockpit

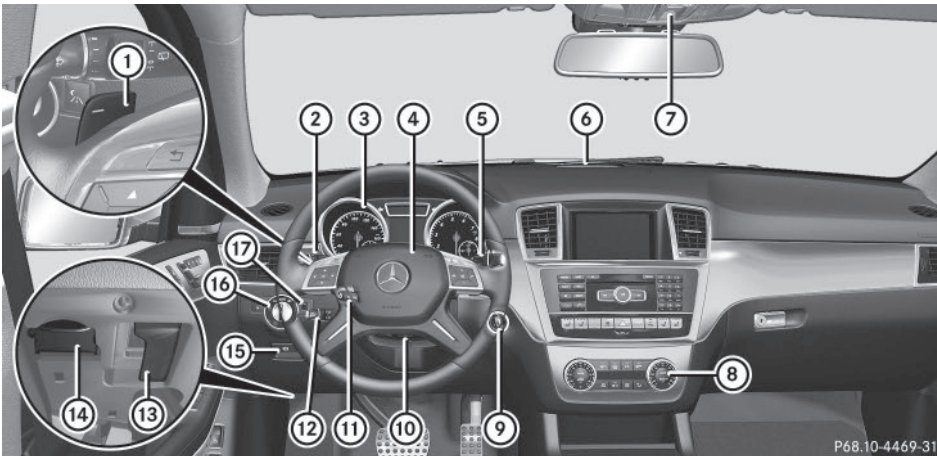

P68.10-4469-31

	Function	Page
①	Steering wheel paddle shifters	
②	Combination switch	115
③	Instrument cluster	41
④	Horn	
⑤	DIRECT SELECT lever	140
⑥	PARKTRONIC warning display	168
⑦	Overhead control panel	47
⑧	Climate control systems	124
⑨	Ignition lock Start/Stop button	135 135

	Function	Page
⑩	Adjusts the steering wheel manually	
⑪	Adjusts the steering wheel electrically Steering wheel heating	 
⑫	Cruise control lever	155
⑬	Opens the hood	266
⑭	Diagnostics connection	34
⑮	Electric parking brake	
⑯	Light switch	114
⑰	Night View Assist Plus	175



## Instrument cluster

## Displays and controls

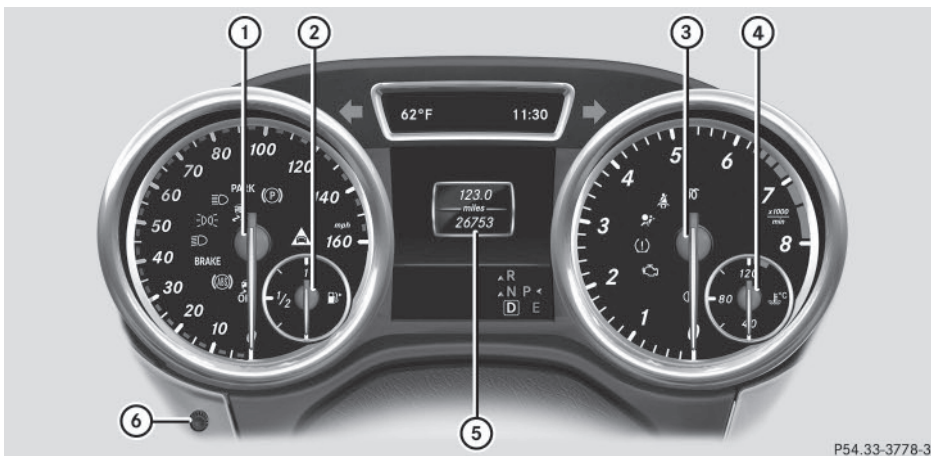

P54.33-3778-31

At a glance

	Function	Page		Function	Page
①	Speedometer Speedometer segments		③	Tachometer	
②	Fuel gauge Fuel filler flap location indicator : the fuel filler cap is on the right-hand side.		④	Coolant temperature	
			⑤	Multifunction display	
			⑥	Instrument cluster lighting	

- i** Information on displaying the outside temperature in the multifunction display can be found under "Outside temperature display" in the Digital Operator's Manual.

## Warning and indicator lamps

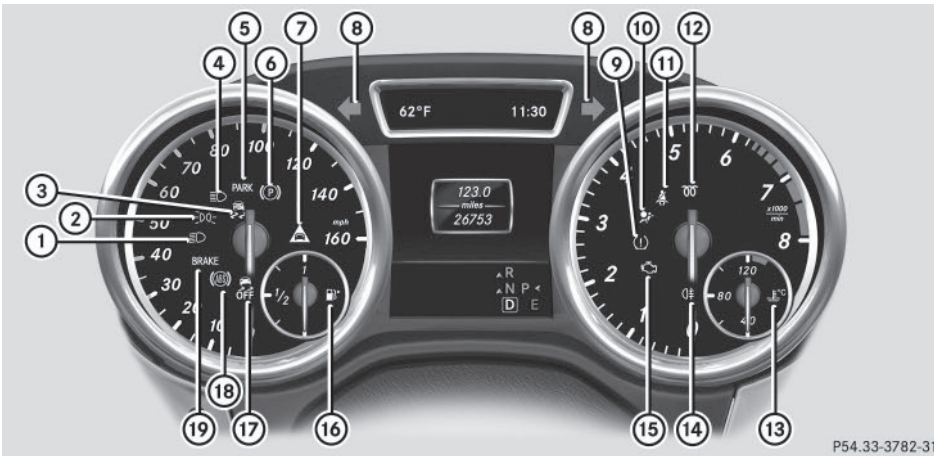

P54.33-3782-31

	Function	Page
①	Low-beam head-lamps	
②	Parking lamps	
③	ESP®	220
④	High-beam head-lamps	
⑤	Electric parking brake (red) (USA only) (Canada only)	
⑥	Electric parking brake (yellow)	
⑦	Distance warning	224
⑧	Turn signals	
⑨	Tire pressure monitor	225

	Function	Page
⑩	Restraint system	50
⑪	Seat belts	214
⑫	Diesel engine: pre-glow	
⑬	Coolant	223
⑭	Rear fog lamp	
⑮	Check Engine	
⑯	Reserve fuel	
⑰	ESP® OFF	220
⑱	ABS	217
⑲	Brakes (USA only) (Canada only)	216

Multifunction steering wheel



At a glance

	Function	Page
①	Multifunction display	
②	COMAND display	
③	 Switches on the Voice Control System (see the separate operating instructions)	
④	 Rejects or ends a call Exits the telephone book / redial memory  Makes or accepts a call Switches to the redial memory  Adjusts the volume  Mute	

	Function	Page
⑤	 Selects a menu  Selects a submenu or scrolls through lists  Confirms selections and hides messages	
⑥	 Back Switches off the Voice Control System (see the separate operating instructions)	





## Center console

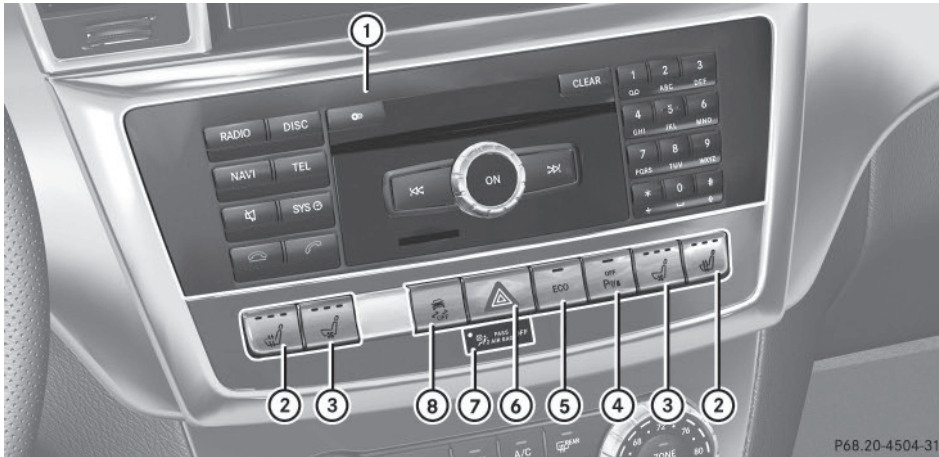

## Center console, upper section

At a glance



P68.20-4504-31

	Function	Page
①	Audio 20 or COMAND; see the separate operating instructions	
②	 Seat heating	110
③	 Seat ventilation	110
④	 PARKTRONIC	168
⑤	 ECO start/stop function	139

	Function	Page
⑥	 Hazard warning lamps	114
⑦	 PASSENGER AIR BAG OFF indicator lamp	51
⑧	 ESP®	79

## Center console, lower section

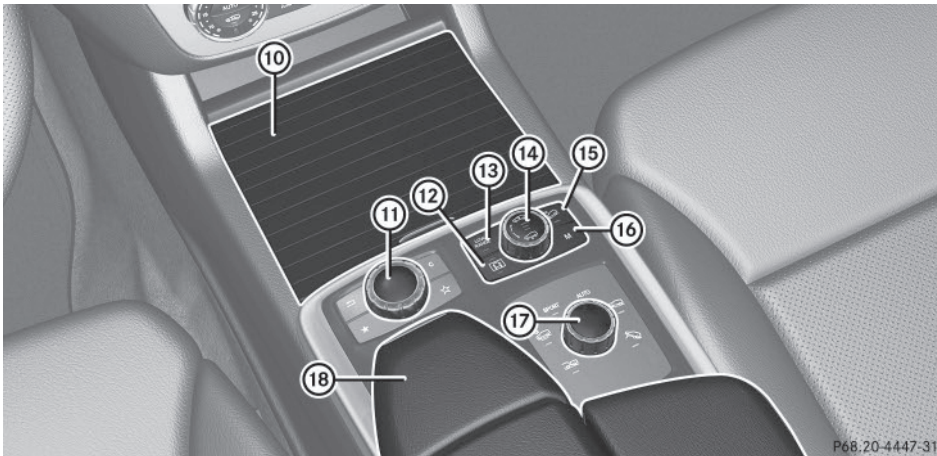

At a glance

**i** Vehicles with the ON&OFFROAD package

	Function	Page		Function	Page	
⑩	Cup holder		⑭	Level control selector wheel	162	
	Ashtray			⑮	DSR (Downhill Speed Regulation)	187
	Cigarette lighter				⑯	Manual drive program
	Socket			⑰		Selector wheel for on-road programs
⑪	Audio or COMAND controller		Selector wheel for off-road programs		188	
	⑫	ON&OFFROAD menu button	189	⑰	Selector wheel for on-road programs	185
⑬	LOW RANGE off-road gear	188	⑰		Selector wheel for off-road programs	188
				⑱	Stowage compartment with Media Interface	

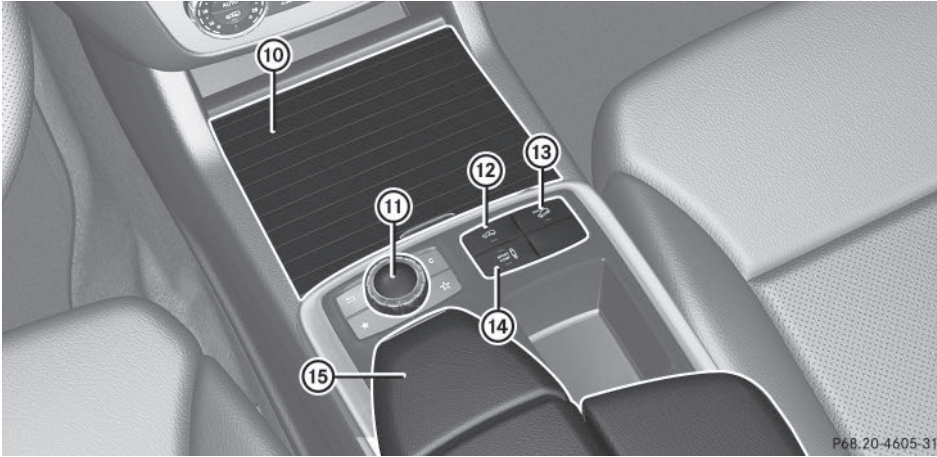

**i** Vehicles without the ON&OFFROAD package and Mercedes-AMG vehicles

	Function	Page
⑩	Cup holder Ashtray Cigarette lighter Socket	
⑪	Audio or COMAND controller	
⑫	Level control	165

	Function	Page
⑬	DSR (Downhill Speed Regulation)	187
⑭	Adaptive Damping System Sets AMG RIDE CONTROL (Mercedes-AMG vehicles)	 167
⑮	Stowage compartment	



Overhead control panel

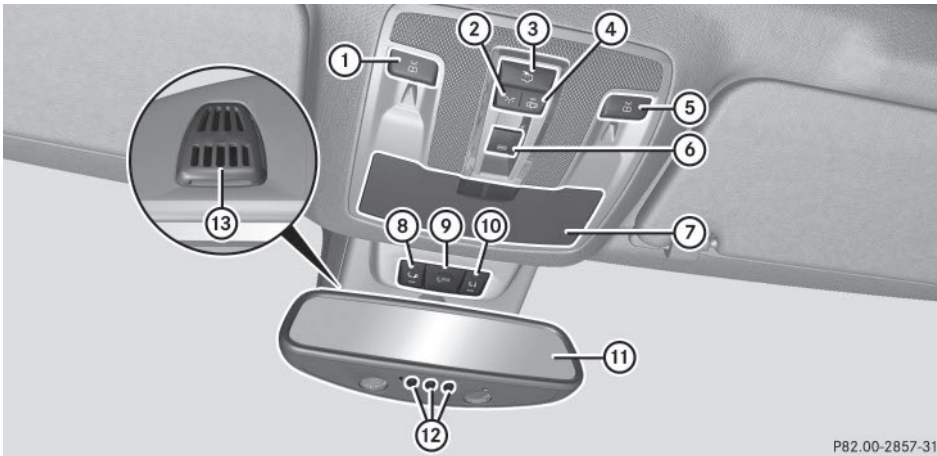

P82.00-2857-31

At a glance

	Function	Page		Function	Page
①	Switches the left-hand reading lamp on or off		⑦	Eyeglasses compartment	
②	Switches the front interior lighting on		⑧	Roadside Assistance call button (mbrace system)	258
③	Switches the rear interior lighting on or off		⑨	SOS button (mbrace system)	257
④	Switches the front interior lighting or automatic interior lighting control off		⑩	MB Info call button (mbrace system)	259
⑤	Switches the right-hand reading lamp on or off		⑪	Rear-view mirror	
⑥	Opens or closes the sliding sunroof Opens or closes the panorama roof with power tilt/sliding panel with roller sunblinds	103 104	⑫	Buttons for the garage door opener	261
			⑬	Microphone for mbrace (emergency call system), telephone and the Voice Control System <sup>1</sup>	

<sup>1</sup> The Voice Control System only available in combination with COMAND. Please observe the separate operating instructions.

## Door control panel

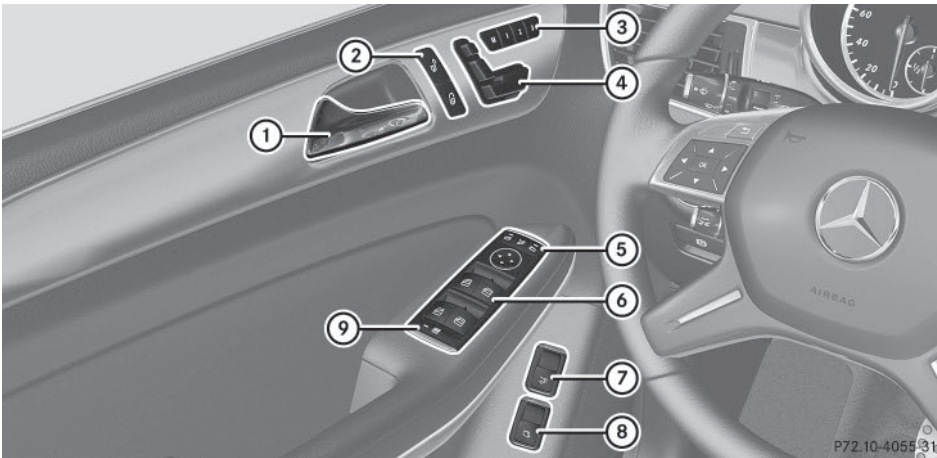

	Function	Page
①	Opens the door	
②	Unlocks/locks the vehicle	
③	 Stores settings for the seat, exterior mirrors and steering column (memory function)	
④	Adjusts the seats	109
⑤	 Adjusts and folds the exterior mirrors in/out electrically	

	Function	Page
⑥	Opens/closes the side windows	
⑦	Opens/closes the tailgate	99
⑧	Opens/closes the hinged side windows electrically	
⑨	Activates/deactivates the override feature for the side windows in the rear compartment	



Useful information .....	50
Panic alarm .....	50
Occupant safety .....	50
Children in the vehicle .....	67
Pets in the vehicle .....	73
Driving safety systems .....	74
Protection against theft .....	84

### Useful information

- i** This Operator's Manual describes all models and all standard and optional equipment of your vehicle available at the time of publication of the Operator's Manual. Country-specific differences are possible. Please note that your vehicle may not be equipped with all features described. This also applies to safety-related systems and functions.
- i** Read the information on qualified specialist workshops (▷ page 35).

### Panic alarm



- ▶ **To activate:** press **PANIC** button ① for at least one second.  
A visual and audible alarm is triggered if the alarm system is armed.
  - ▶ **To deactivate:** press **PANIC** button ① again.
- or
- ▶ Insert the SmartKey into the ignition lock.
- or
- ▶ Press the KEYLESS-GO Start/Stop button.  
The KEYLESS-GO key must be in the vehicle.

### Occupant safety

#### Introduction to the restraint system

The restraint system can reduce the risk of vehicle occupants coming into contact with parts of the vehicle's interior in the event of an accident. The restraint system can also reduce the forces to which vehicle occupants are subjected during an accident.

The restraint system comprises:

- Seat belt system
- Air bags
- Child restraint system
- Child seat securing systems

The components of the restraint system work in conjunction with each other. They can only deploy their protective function if, at all times, all vehicle occupants:

- have fastened their seat belts correctly (▷ page 53)
- have adjusted their seat and head restraint properly (▷ page 109).

As the driver, you also have to make sure that the steering wheel is adjusted correctly. Observe the information relating to the correct driver's seat position (▷ page 108).

You also have to make sure that an air bag can inflate properly if deployed (▷ page 56).

An air bag supplements a correctly worn seat belt. As an additional safety device, the air bag increases the level of protection for vehicle occupants in the event of an accident. For example, if, in the event of an accident, the protection offered by the seat belt is sufficient, the air bags are not deployed. When an accident occurs, only the air bags that increase protection in that particular accident situation are deployed. However, seat belts and air bags generally do not protect against objects penetrating the vehicle from the outside.

Information on restraint system operation can be found under "Triggering of the Emergency Tensioning Devices and air bags" (▷ page 64).

For more information about children traveling with you in the vehicle and on child restraint systems, see "Children in the vehicle" (▷ page 67).

### Important safety notes

#### WARNING

Modifications to the restraint system may cause it to no longer work as intended. The restraint system may then not perform its intended protective function and may fail in an accident or trigger unexpectedly, for example. This poses an increased risk of injury or even fatal injury.

Never modify parts of the restraint system. Never tamper with the wiring, the electronic components or their software.

If it is necessary to modify an air bag system to accommodate a person with disabilities, contact an authorized Mercedes-Benz Center for details. USA only: for further information contact our Customer Assistance Center at 1-800-FOR-MERCEDES (1-800-367-6372).

### Restraint system warning lamp

The functions of the restraint system are checked after the ignition is switched on and at regular intervals while the engine is running. Therefore, malfunctions can be detected in good time.

The  restraint system warning lamp in the instrument cluster lights up when the ignition is switched on. It goes out no later than a few seconds after the vehicle is started. The components of the restraint system are in operational readiness.

A malfunction has occurred if the  restraint system warning lamp:

- does not light up after the ignition is switched on
- does not go out after a few seconds with the engine running
- lights up again while the engine is running

#### WARNING

If restraint system is malfunctioning, restraint system components may be triggered unintentionally or might not be triggered at all in the event of an accident with a high rate of vehicle deceleration. This can affect the Emergency Tensioning Device or air bag, for example. This poses an increased risk of injury or even fatal injury.

Have the restraint system checked and repaired in a qualified specialist workshop as soon as possible.

### PASSENGER AIR BAG OFF indicator lamp



PASSENGER AIR BAG OFF indicator lamp ① is part of the Occupant Classification System (OCS).

The PASSENGER AIR BAG OFF indicator lamp informs you about the status of the front-passenger front air bag.

**If the PASSENGER AIR BAG OFF indicator lamp:**

- **is lit:** the front-passenger front air bag is deactivated. It will then not be deployed in the event of an accident.
- **does not light up:** the front-passenger front air bag is enabled. If, in the event of an accident, all deployment criteria are met, the front-passenger front air bag is deployed.

Depending on the person in the front-passenger seat, the front-passenger front air bag must either be deactivated or enabled; see the following points. You must make sure of this both before and during a journey.

- **Children in a child restraint system:** whether the front-passenger front air bag is enabled or deactivated depends on the installed child restraint system, and the age and size of the child. Therefore, be sure to observe the notes on the "Occupant Classification System (OCS)" (▷ page 59) and on "Children in the vehicle" (▷ page 67). There you will also find instructions on rearward and forward-facing child restraint systems on the front-passenger seat.
- **All other persons:** depending on the classification of the person in the front-passenger seat, the front-passenger front air bag is enabled or deactivated (▷ page 59). Be sure to observe the notes on "Seat belts" (▷ page 52) and "Air bags" (▷ page 56). There you can also find information on the correct seat position.

## Seat belts

### Introduction

Seat belts are the most effective means of restricting the movement of vehicle occupants in the event of an accident or the vehicle rolling over. This reduces the risk of vehicle occupants coming into contact with parts of the vehicle interior or being ejected from the vehicle. Furthermore, the seat belt helps to keep the vehicle occupant in the best position in relation to the air bag.

The seat belt system comprises:

- Seat belts
- Emergency Tensioning Devices for the front seat belts and the outer seat belts in the second row of seats as well as the seat belts in the third row
- Belt force limiters for the front seat belts and the outer seat belts in the second row

of seats as well as the seat belts in the third row

If the seat belt is pulled out of the belt outlet quickly or with a jerky movement, the belt retractor locks. The belt strap cannot be extracted any further.

The Emergency Tensioning Device tightens the seat belt in an accident, pulling the belt close against the body. However it does not pull the vehicle occupant back in the direction of the backrest.

The Emergency Tensioning Device does not correct an incorrect seat position or the routing of an incorrectly fastened seat belt.

When triggered, a belt force limiter helps to reduce the force exerted by the seat belt on the vehicle occupant.

The belt force limiters for the front seats are synchronized with the front air bags, which absorb part of the deceleration force. This can reduce the force exerted on the vehicle occupants during an accident.

**!** If the front-passenger seat is unoccupied, do not insert the belt tongue into the buckle of the front-passenger seat. This may otherwise lead to the triggering of the Emergency Tensioning Device in the event of an accident, which will then need to be replaced.

### Important safety notes

The use of seat belts and child restraint systems is required by law in:

- all 50 states
- the U.S. territories
- the District of Columbia
- all Canadian provinces

Even where this is not required by law, all vehicle occupants should correctly fasten their seat belts before starting the journey.

#### **WARNING**

If the seat belt is incorrectly fastened, it cannot protect as intended. Furthermore, an incorrectly fastened seat belt can cause addi-

tional injury, for example, in an accident, during braking or when abruptly changing direction. This poses an increased risk of injury or even fatal injury.

Make sure that all vehicle occupants are seated properly with a correctly fastened seat belt.

#### **WARNING**

The seat belt does not offer the intended level of protection if you have not moved the backrest to an almost vertical position. When braking or in the event of an accident, you could slide underneath the seat belt and sustain abdomen or neck injuries, for example. This poses an increased risk of injury or even fatal injury.

Adjust the seat properly before beginning your journey. Always ensure that the backrest is in an almost vertical position and that the shoulder section of your seat belt is routed across the center of your shoulder.

#### **WARNING**

Persons under 5 ft (1.50 m) in height cannot fasten the seat belt correctly without an additional suitable restraint system. If the seat belt is incorrectly fastened, it cannot protect as intended. Furthermore, an incorrectly fastened seat belt can cause additional injury, for example, in an accident, during braking or an abrupt change of direction. This poses an increased risk of injury or even fatal injury.

For this reason, always secure persons under 5 ft (1.50 m) in height in suitable restraint systems.

If a child younger than twelve years old and under 5 ft (1.50 m) in height is traveling in the vehicle:

- always secure the child in a child restraint system suitable for this Mercedes-Benz vehicle. The child restraint system must be

appropriate to the age, weight and size of the child

- always observe the instructions and safety notes in the "Children in the vehicle" section of this Operator's Manual (> page 67) in addition to the child restraint system manufacturer's installation instructions
- be sure to observe the instructions and safety notes on the "Occupant classification system (OCS)" (> page 59)

#### **WARNING**

The seat belts may not perform their intended protective function if:

- they are damaged, modified, extremely dirty, bleach or dyed
- the seat belt buckle is damaged or extremely dirty
- the Emergency Tensioning Devices, belt anchorages or inertia reels have been modified

Seat belts may sustain non-visible damage in an accident, e.g. due to glass splinters. Modified or damaged seat belts may tear or fail, e.g. in an accident. Modified Emergency Tensioning Devices could accidentally trigger or fail to deploy when necessary. This poses an increased risk of injury or even fatal injury.

Never modify the seat belts, Emergency Tensioning Devices, belt anchorages or inertia reels. Make sure that the seat belts are undamaged, not worn out and clean. Following an accident, have the seat belts checked immediately at a qualified specialist workshop.

Only use seat belts that have been approved for your vehicle by Mercedes-Benz.

### **Proper use of the seat belts**

Observe the safety notes on the seat belt (> page 52).

All vehicle occupants must be wearing the seat belt correctly before beginning the journey. Also make sure that all vehicle occu-

pants are always wearing the seat belt correctly while the vehicle is in motion.

When fastening the seat belt, always make sure that:

- the seat belt tongue is only inserted to the belt buckle belonging to that seat.
- the seat belt is tight across your body. Avoid wearing bulky clothing, e.g. a winter coat.
- the seat belt is not twisted. Only then can the forces which occur be distributed over the area of the belt.
- the shoulder section of the belt is always routed across the center of your shoulder. The shoulder section of the belt must not come into contact with your neck or be routed under your arm. Where possible, adjust the seat belt to the appropriate height.
- the lap belt passes tightly and as low down as possible across your lap. The lap belt must always be routed across your hip joints and not across your abdomen. This applies particularly to pregnant women. If necessary, push the lap belt down to your hip joint and pull it tight using the shoulder section of the belt.
- the seat belt is not routed across sharp, pointed or fragile objects. If you have such items located on or in your clothing, e.g. pens, keys or eyeglasses, store these in a suitable place.
- only one person is using a seat belt at a time. Infants and children must never travel sitting on the lap of a vehicle occupant. In the event of an accident, they could be crushed between the vehicle occupant and seat belt.
- objects are never secured with a seat belt if the seat belt is also being used by one of the vehicle's occupants.

Seat belts are only intended to secure and restrain vehicle occupants. Always observe

the "Loading guidelines" for securing objects, luggage or loads (▷ page 248).

### Fastening and adjusting the seat belts

Observe the safety notes on the seat belt (▷ page 52) and the notes on correct use of seat belts (▷ page 53).

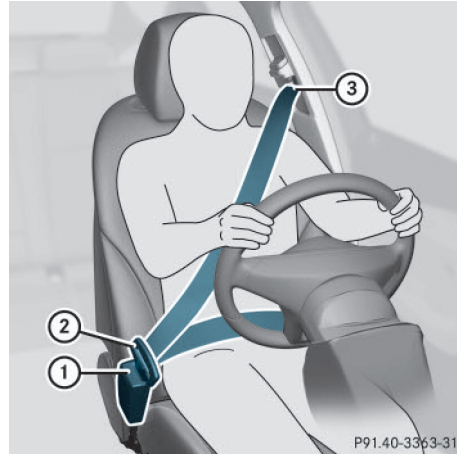

Basic illustration

- ▶ Adjust the seat (▷ page 108). The seat backrest must be in an almost vertical position.
- ▶ Pull the seat belt smoothly from belt outlet ③ and engage belt tongue ② into belt buckle ①. The seat belt on the driver's seat and the front-passenger seat may be tightened automatically, see "Belt adjustment" (▷ page 55).
- ▶ If necessary, pull upwards on the shoulder section of the seat belt to tighten the belt across your body.

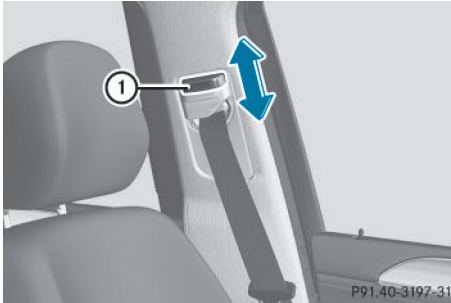

The shoulder section of the seat belt must always be routed across the center of the shoulder. Adjust the belt outlet if necessary.

- ▶ **To raise:** slide the belt outlet upwards. The belt outlet will engage in various positions.
- ▶ **To lower:** hold belt outlet release ① and slide belt outlet downwards.
- ▶ Let go of belt outlet release ① in the desired position and make sure that the belt outlet engages.

All seat belts except the driver's seat belt are equipped with a special seat belt retractor to securely fasten child restraint systems in the vehicle. Further information can be found under "Special seat belt retractor" (▷ page 67).

### Releasing seat belts

- ❗ Make sure that the seat belt is fully rolled up. Otherwise, the seat belt or belt tongue will be trapped in the door or in the seat mechanism. This could damage the door, the door trim panel and the seat belt. Damaged seat belts can no longer fulfill their protective function and must be replaced. Visit a qualified specialist workshop.

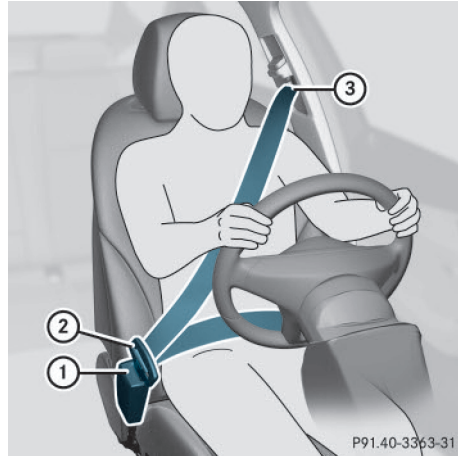

Basic illustration

- ▶ Press release button ①, hold belt tongue ② firmly and guide it back towards belt outlet ③.

### Seat belt adjustment

The seat-belt adjustment is an integral part of the PRE-SAFE® convenience function. This function adjusts the driver's and front-passenger seat belt to the upper body of the occupants.

The belt strap is tightened slightly when:

- the belt tongue is engaged in the buckle and
- the ignition is switched on

The seat-belt adjustment will apply a certain retraction force if any slack is detected between the vehicle occupant and the seat belt. Do not hold on to the seat belt tightly while it is adjusting.



You can switch the seat-belt adjustment on and off in the on-board computer.

### Belt warning for the driver and front passenger

The  seat belt warning lamp in the instrument cluster is a reminder that all vehicle occupants must wear their seat belts. It may



light up continuously or flash. In addition, there may be a warning tone.

Regardless of whether the driver's seat belt has already been fastened, the  seat belt warning lamp lights up for six seconds each time the engine is started. If, after six seconds, the driver or front-passenger seat belt has not been fastened and the doors are closed, the  seat belt warning lamp lights up. As soon as the driver's and front-passenger seat belts are fastened or a front door is opened again, the  seat belt warning lamp goes out.

If the driver's seat belt is not fastened after the engine is started, an additional warning tone will sound. This warning tone stops after six seconds or when the driver's seat belt is fastened.

If the vehicle's speed exceeds 15 mph (25 km/h) once and the driver's and front-passenger seat belts are not fastened, a warning tone sounds. A warning tone also sounds with increasing intensity for 60 seconds or until the driver or front passenger have fastened their seat belts.

If the driver or front passenger unfasten their seat belts during the journey, the seat belt warning is activated again.

**i** For more information on the  seat belt warning lamp, see "Warning and indicator lamps in the instrument cluster, seat belts" (> page 214).

## Air bags

### Introduction

The installation point of an air bag can be recognized by the AIR BAG symbol.

An air bag complements the correctly fastened seat belt. It is no substitute for the seat belt. The air bag provides additional protection in applicable accident situations.

Not all air bags are deployed in an accident. The different air bag systems function independently from one another (> page 64).

However, no system available today can completely eliminate injuries and fatalities.

It is also not possible to rule out a risk of injury caused by an air bag due to the high speed at which the air bag must be deployed.

### Important safety notes

#### WARNING

If you do not sit in the correct seat position, the air bag cannot protect as intended and could even cause additional injury when deployed. This poses an increased risk of injury or even fatal injury.

To avoid hazardous situations, always make sure that all of the vehicle's occupants:

- have fastened their seat belts correctly, including pregnant women
- are sitting correctly and maintain the greatest possible distance to the air bags
- follow the following instructions

Always make sure that there are no objects between the air bag and the vehicle's occupants.

- Adjust the seats properly before beginning your journey. Always make sure that the seat is in an almost upright position. The center of the head restraint must support the head at about eye level.
- Move the driver's and front-passenger seats as far back as possible. The driver's seat position must allow the vehicle to be driven safely.
- Only hold the steering wheel on the outside. This allows the air bag to be fully deployed.
- Always lean against the backrest while driving. Do not lean forwards or lean against the door or side window. You may otherwise be in the deployment area of the air bags.
- Always keep your feet in the footwell in front of the seat. Do not put your feet on the dashboard, for example. Your feet may oth-



erwise be in the deployment area of the air bag.

- For this reason, always secure persons less than 5 ft (1.50 m) tall in suitable restraint systems. Up to this height, the seat belt cannot be worn correctly.

**If a child is traveling in your vehicle, also observe the following notes:**

- Always secure children under twelve years of age and less than 5 ft (1.50 m) tall in suitable child restraint systems.
- Child restraint systems should be installed on the rear seats.
- Only secure a child in a rearward-facing child restraint system on the front-passenger seat when the front-passenger front air bag is deactivated. If the PASSENGER AIR BAG OFF indicator lamp is permanently lit, the front-passenger front air bag is deactivated (▷ page 51).
- Always observe the instructions and safety notes on the "Occupant Classification System (OCS)" (▷ page 59) and on "Children in the vehicle" (▷ page 67) in addition to the child restraint system manufacturer's installation instructions.

**Objects in the vehicle interior may prevent an air bag from functioning correctly.**

Before starting your journey and to avoid risks resulting from the speed of the air bag as it deploys, make sure that:

- there are no people, animals or objects between the vehicle occupants and an air bag.
- there are no objects between the seat, door and B-pillar.
- no hard objects, e.g. coat hangers, hang on the grab handles or coat hooks.
- no accessories, such as cup holders, are attached to the vehicle within the deployment area of an air bag, e.g. to doors, side windows, rear side trim or side walls.
- no heavy, sharp-edged or fragile objects are in the pockets of your clothing. Store such objects in a suitable place.

**⚠ WARNING**

If you modify the air bag cover or affix objects such as stickers to it, the air bag can no longer function correctly. There is an increased risk of injury.

Never modify an air bag cover or affix objects to it.

**⚠ WARNING**

Sensors to control the air bags are located in the doors. Modifications or work not performed correctly to the doors or door paneling, as well as damaged doors, can lead to the function of the sensors being impaired. The air bags might therefore not function properly anymore. Consequently, the air bags cannot protect vehicle occupants as they are designed to do. There is an increased risk of injury.

Never modify the doors or parts of the doors. Always have work on the doors or door paneling carried out at a qualified specialist workshop.

### Front air bags

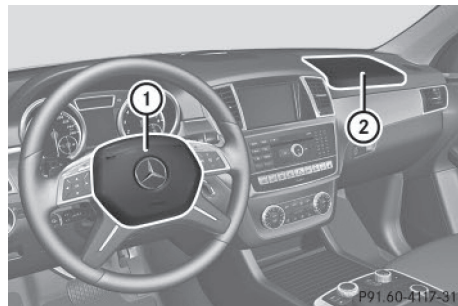

Driver's air bag ① deploys in front of the steering wheel. Front-passenger front air bag ② deploys in front of and above the glove box.

When deployed, the front air bags offer additional head and thorax protection for the occupants in the front seats.

The PASSENGER AIR BAG OFF indicator lamp informs you about the status of the front-passenger front air bag (▷ page 51).

The front-passenger front air bag will only deploy if:

- the system, based on the OCS weight sensor readings, detects that the front-passenger seat is occupied (▷ page 59)
- the PASSENGER AIR BAG OFF indicator lamp is not lit (▷ page 60)
- the restraint system control unit predicts a high accident severity

### Driver's knee bag

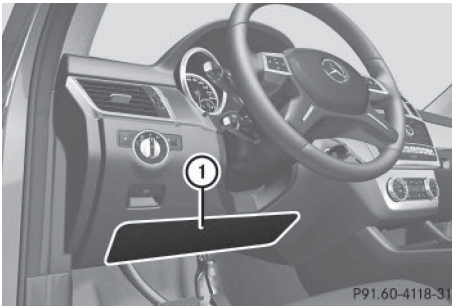

Driver's knee bag ① deploys under the steering column. The driver's knee bag is triggered together with the front air bag.

The driver's knee bag offers additional thigh, knee and lower leg protection for the occupant in the driver's seat.

### Side impact air bags

#### WARNING

Unsuitable seat covers could restrict or even prevent the deployment of the air bags integrated into the seats. Consequently, the air bags cannot protect vehicle occupants as they are designed to do. In addition, the function of the Occupant Classification System (OCS) could be restricted. This poses an increased risk of injury or even fatal injury. You should only use seat covers that have been approved for the respective seat by Mercedes-Benz.

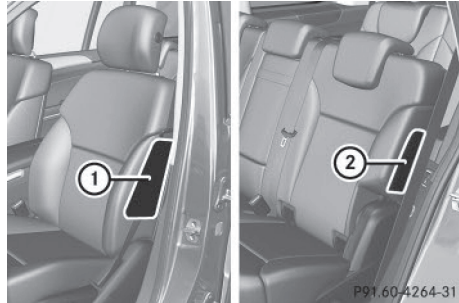

Front side impact air bags ① and second row rear side impact air bags ② deploy next to the outer bolster of the seat backrest.

When deployed, the side impact air bag offers additional thorax protection. It also offers additional pelvis protection for occupants in the front seats. However, it does not protect the:

- head
- neck
- arms

In the event of a side impact, the side impact air bag is deployed on the side on which the impact occurs.

The side impact air bag on the front-passenger side (front) deploys under the following conditions:

- the OCS system detects that the front-passenger seat is occupied or
- the belt tongue is engaged in the belt buckle of the front-passenger seat

If the belt tongue is engaged in the belt buckle, the side impact air bag on the front-passenger side deploys if an appropriate accident situation occurs. In this case, deployment is independent of whether the front-passenger seat is occupied or not.

## Window curtain air bags

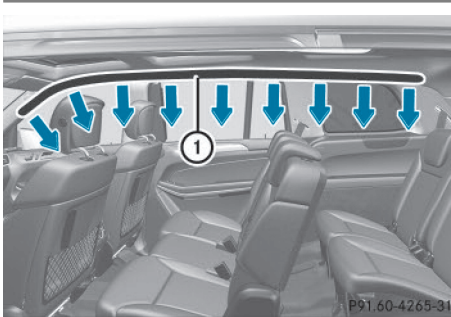

Window curtain air bags ① are integrated into the side of the roof frame and deploy in the area extending from the front door (A-pillar) to the rear side window (D-pillar).

When deployed, the window curtain air bag enhances the level of protection for the head. However, it does not protect the chest or arms.

In the event of a side impact, the window curtain air bag is deployed on the side on which the impact occurs.

If the system determines that they can offer additional protection to that provided by the seat belt, a window curtain air bag may be deployed in other accident situations (▷ page 64).

## Occupant Classification System (OCS)

### Introduction

The Occupant Classification System (OCS) categorizes the person in the front-passenger seat. Depending on that result, the front-passenger front air bag is either enabled or deactivated.

The system does not deactivate:

- the side impact air bag
- the window curtain air bag
- the Emergency Tensioning Devices

In the following situation, the side impact air bag and the Emergency Tensioning Device are deactivated:

- OCS has not categorized the person on the front-passenger seat as an adult or a person of corresponding stature and
- the seat belt tongue of the seat belt is not inserted into the front-passenger seat belt buckle.

### Prerequisites

To be classified correctly, the front passenger must sit:

- with the seat belt fastened correctly
- in an almost upright position with their back against the seat backrest
- with their feet resting on the floor, if possible

If the front passenger does not observe these conditions, OCS may produce a false classification, e.g. because the front passenger:

- transfers their weight by supporting themselves on a vehicle armrest
- sits in such a way that their weight is raised from the seat cushion

If it is absolutely necessary to install a child restraint system on the front-passenger seat, be sure to observe the correct positioning of the child restraint system. Never place objects under or behind the child restraint system, e.g. cushions. The entire base of the child restraint system must always rest on the seat cushion of the front-passenger seat. The backrest of the forward-facing child restraint system must lie as flat as possible against the backrest of the front-passenger seat.

The child restraint system must not touch the roof or be subjected to a load by the head restraint. Adjust the angle of the seat backrest and the head restraint position accordingly.

Only then can OCS be guaranteed to function correctly. Always observe the child restraint system manufacturer's installation instructions.

### Occupant Classification System operation (OCS)



PASSENGER AIR BAG OFF indicator lamp ① shows you whether the front-passenger front air bag is deactivated.

- ▶ Turn the SmartKey to position **1** or **2** in the ignition lock or on vehicles with KEYLESS-GO, press the Start/Stop button once or twice.

The system carries out self-diagnostics.

The PASSENGER AIR BAG OFF indicator lamp must light up for approximately six seconds. The PASSENGER AIR BAG OFF indicator lamp then displays the status of the front-passenger front air bag. If the status of the front-passenger front air bag changes while the vehicle is in motion, an air bag display message may appear in the instrument cluster (▷ page 201). When the front-passenger seat is occupied, always pay attention to the PASSENGER AIR BAG OFF indicator lamp. Be aware of the status of the front-passenger front air bag both before and during the journey.

#### If the PASSENGER AIR BAG OFF indicator lamp:

- **is lit:** the front-passenger front air bag is deactivated. It will then not be deployed in the event of an accident.
- **does not light up:** the front-passenger front air bag is enabled. If, in the event of an accident, all deployment criteria are met, the front-passenger front air bag is deployed.

#### **WARNING**

If the PASSENGER AIR BAG OFF indicator lamp is lit, the front-passenger front air bag is disabled. It will not be deployed in the event of an accident and cannot perform its intended protective function. A person in the front-passenger seat could then, for example, come into contact with the vehicle's interior, especially if the person is sitting too close to the dashboard. This poses an increased risk of injury or even fatal injury.

When the front-passenger seat is occupied, always ensure that:

- the classification of the person in the front-passenger seat is correct and the front-passenger front air bag is enabled or disabled in accordance with the person in the front-passenger seat
- the front-passenger seat has been moved back as far back as possible.
- the person is seated correctly.

Make sure, both before and during the journey, that the status of the front-passenger front air bag is correct.

#### **WARNING**

If you secure a child in a child restraint system on the front-passenger seat and the PASSENGER AIR BAG OFF indicator lamp is off, the front-passenger front air bag can deploy in the event of an accident. The child could be struck by the air bag. This poses an increased risk of injury or even fatal injury.

Make sure that the front-passenger front air bag has been disabled. The PASSENGER AIR BAG OFF indicator lamp must be lit.

 **WARNING**

If you secure a child in a forward-facing child restraint system on the front-passenger seat and you position the front-passenger seat too close to the dashboard, the child could, in the event of an accident:

- come into contact with the vehicle's interior if the PASSENGER AIR BAG OFF indicator lamp is lit, for example
- be struck by the air bag if the PASSENGER AIR BAG OFF indicator lamp is off

This poses an increased risk of injury or even fatal injury.

Move the front-passenger seat as far back as possible. Always make sure that the shoulder belt strap is correctly routed from the vehicle belt sash guide to the shoulder belt guide on the child restraint system. The shoulder belt strap must be routed forwards and downwards from the vehicle belt sash guide. If necessary, adjust the vehicle belt sash guide and the front-passenger seat accordingly. Always observe the child restraint system manufacturer's installation instructions.

If OCS determines that:

- the front-passenger seat is unoccupied, the PASSENGER AIR BAG OFF indicator lamp lights up after the system self-test and remains lit. This indicates that the front-passenger front air bag is deactivated.
- the front-passenger seat is occupied by a child of up to twelve months old, in a standard child restraint system, the PASSENGER AIR BAG OFF indicator lamp lights up after the system self-test and remains lit. This indicates that the front-passenger front air bag is deactivated.

But even in the case of a twelve-month-old child, in a standard child restraint system, the PASSENGER AIR BAG OFF indicator lamp can go out after the system self-test. This indicates that the front-passenger front air bag is activated. The result of the classification is dependent on, among other factors, the child restraint system

and the child's stature. It is recommended that you install the child restraint system on a suitable rear seat.

- the front-passenger seat is occupied by a person of smaller stature (e.g. a teenager or small adult), the PASSENGER AIR BAG OFF indicator lamp lights up and remains lit after the system self-test depending on the result of the classification or, alternatively, goes out.
  - If the PASSENGER AIR BAG OFF indicator lamp is off, move the front-passenger seat as far back as possible. Alternatively, a person of smaller stature can sit on a rear seat.
  - If the PASSENGER AIR BAG OFF indicator lamp is lit, a person of smaller stature should not use the front-passenger seat.
- the front-passenger seat is occupied by an adult or a person of a stature corresponding to that of an adult, the PASSENGER AIR BAG OFF indicator lamp goes out after the system self-test. This indicates that the front-passenger front air bag is activated.

If children are traveling in the vehicle, be sure to observe the notes on "Children in the vehicle" (▷ page 67).

When OCS is malfunctioning, the red  restraint system warning lamp in the instrument cluster and the PASSENGER AIR BAG OFF indicator lamp light up simultaneously. The front-passenger front air bag is deactivated in this case and does not deploy during an accident. Have the system checked by qualified technicians as soon as possible. Consult an authorized Mercedes-Benz Center. The front-passenger seat should only be repaired at an authorized Mercedes-Benz Center.

If the front-passenger seat, the seat cover or the seat cushion is damaged, have the necessary repair work carried out at an authorized Mercedes-Benz Center.

For safety reasons, Mercedes-Benz recommends that you only use seat accessories that have been approved by Mercedes-Benz.

If the driver's air bag deploys, this does not mean that the front-passenger front air bag will also deploy. The Occupant Classification System (OCS) categorizes the occupant in the front-passenger seat. Depending on that result, the front-passenger front air bag is either enabled or deactivated.

### System self-test

#### DANGER

If the PASSENGER AIR BAG OFF indicator lamp does not light up during the system self-test, then the system is malfunctioning. The front-passenger front air bag might be triggered unintentionally or might not be triggered at all in the event of an accident with high deceleration. This poses an increased risk of injury or even fatal injury.

In this case the front-passenger seat may not be used. Do not install a child restraint system on the front-passenger seat. Have the Occupant Classification System (OCS) checked and repaired immediately at a qualified specialist workshop.

#### DANGER

If the PASSENGER AIR BAG OFF indicator lamp remains lit after the system self-test, the front-passenger front air bag is disabled. It will not be deployed in the event of an accident. In this case, the front-passenger front air bag cannot perform its intended protective function, e.g. when a person is seated in the front-passenger seat.

That person could, for example, come into contact with the vehicle's interior, especially if the person is sitting too close to the dashboard. This poses an increased risk of injury or even fatal injury.

When the front-passenger seat is occupied, always ensure that:

- the classification of the person in the front-passenger seat is correct and the front-passenger front air bag is enabled or dis-

abled in accordance with the person in the front-passenger seat

- the person is seated properly with a correctly fastened seatbelt
- the front-passenger seat has been moved back as far back as possible

If the PASSENGER AIR BAG OFF indicator lamp remains lit when it should not, the front-passenger seat may not be used. Do not install a child restraint system on the front-passenger seat. Have the Occupant Classification System (OCS) checked and repaired immediately at a qualified specialist workshop.

#### WARNING

Objects between the seat surface and the child restraint system could affect OCS operation. This could result in the front-passenger air bag not functioning as intended during an accident. This poses an increased risk of injury or even fatal injury.

Do not place any objects between the seat surface and the child restraint system. The entire base of the child restraint system must always rest on the seat cushion of the front-passenger seat. The backrest of the forward-facing child restraint system must, as far as possible, be resting on the backrest of the front-passenger seat. Always comply with the child restraint system manufacturer's installation instructions.

After the system self-test, the PASSENGER AIR BAG OFF indicator lamp displays the status of the front-passenger front air bag (▷ page 60).

For more information about the OCS, see "Problems with the Occupant Classification System" (▷ page 63).



## Problems with the Occupant Classification System (OCS)

Be sure to observe the notes on "System self-test" (▷ page 62).

Problem	Possible causes/consequences and ► Solutions
<p>The PASSENGER AIR BAG OFF indicator lamp lights up and remains lit, even though the front-passenger seat is occupied by an adult or a person of a stature corresponding to that of an adult.</p>	<p>The classification of the person on the front-passenger seat is incorrect.</p> <ul style="list-style-type: none"> <li>▶ Make sure the conditions for a correct classification of the person on the front-passenger seat are met (▷ page 59).</li> <li>▶ If the PASSENGER AIR BAG OFF indicator lamp remains lit, the front-passenger seat may not be used.</li> <li>▶ Have OCS checked as soon as possible at an authorized Mercedes-Benz Center.</li> </ul>
<p>The PASSENGER AIR BAG OFF indicator lamp does not light up and/or does not stay on.</p> <p>The front-passenger seat is:</p> <ul style="list-style-type: none"> <li>• unoccupied</li> <li>• occupied by the weight of a child up to 12 months old in a child restraint system</li> </ul>	<p>OCS is malfunctioning.</p> <ul style="list-style-type: none"> <li>▶ Make sure there is nothing between the seat cushion and the child seat.</li> <li>▶ Make sure that the entire base of the child restraint system rests on the seat cushion of the front-passenger seat. The backrest of the forward-facing child restraint system must lie as flat as possible against the backrest of the front-passenger seat. If necessary, adjust the position of the front-passenger seat.</li> <li>▶ When installing the child restraint system, make sure that the seat belt is tight. Do not pull the seat belt tight using the front-passenger seat adjustment. This could result in the seat belt and the child restraint system being pulled too tightly.</li> <li>▶ Check for correct installation of the child restraint system. Make sure that the head restraint does not apply a load to the child restraint system. If necessary, adjust the head restraint accordingly.</li> <li>▶ Make sure that no objects are applying additional weight onto the seat.</li> <li>▶ If the PASSENGER AIR BAG OFF indicator lamp remains off, do not install a child restraint system on the front-passenger seat. It is recommended that you install the child restraint system on a suitable rear seat.</li> <li>▶ Have OCS checked as soon as possible at an authorized Mercedes-Benz Center.</li> </ul>

## Deployment of Emergency Tensioning Devices and air bags

### Important safety notes

#### WARNING

The air bag parts are hot after an air bag has been deployed. There is a risk of injury.

Do not touch the air bag parts. Have a deployed air bag replaced at a qualified specialist workshop as soon as possible.

#### WARNING

A deployed air bag no longer offers any protection and cannot provide the intended protection in an accident. There is an increased risk of injury.

Have the vehicle towed to a qualified specialist workshop in order to have a deployed air bag replaced.

It is important for your safety and that of your passenger to have deployed air bags replaced and to have any malfunctioning air bags repaired. This will help to make sure the air bags continue to perform their protective function for the vehicle occupants in the event of a crash.

#### WARNING

Pyrotechnic Emergency Tensioning Devices that have been deployed are no longer operational and are unable to perform their intended protective function. This poses an increased risk of injury or even fatal injury.

Therefore, have pyrotechnic Emergency Tensioning Devices which have been triggered immediately replaced at a qualified specialist workshop.

An electric motor is used by PRE-SAFE® to trigger the tightening of the seat belt in hazardous situations. This procedure is reversible.

If Emergency Tensioning Devices are triggered or air bags are deployed, you will hear a bang, and a small amount of powder may also

be released. The  restraint system warning lamp lights up.

Only in rare cases will the bang affect your hearing. The powder that is released generally does not constitute a health hazard, but it may cause short-term breathing difficulties in people with asthma or other respiratory problems. To avoid this, you may wish to get out of the vehicle or open the windows as soon as it is safe to do so.

Air bags and pyrotechnic Emergency Tensioning Devices (ETDs) contain perchlorate material, which may require special handling and regard for the environment. National guidelines must be observed during disposal. In California, see [www.dtsc.ca.gov/HazardousWaste/Perchlorate/index.cfm](http://www.dtsc.ca.gov/HazardousWaste/Perchlorate/index.cfm).

### Method of operation

During the first stage of a collision, the restraint system control unit evaluates important physical data relating to vehicle deceleration or acceleration, such as:

- duration
- direction
- intensity

Based on the evaluation of this data, the restraint system control unit triggers the Emergency Tensioning Devices during a frontal or rear collision.

An Emergency Tensioning Device can only be triggered, if:

- the ignition is switched on
- the components of the restraint system are operational; see "Restraint system warning lamp" (▷ page 51)
- the belt tongue is engaged in the buckle on the respective front-passenger seat

The Emergency Tensioning Devices in the rear compartment are triggered independently of the lock status of the seat belts.

If the restraint system control unit detects a more severe accident, further components of



the restraint system are activated independently of each other in certain frontal collision situations:

- Front air bags and driver's knee bag
- Window curtain air bag, if the system determines that deployment can offer additional protection to that provided by the seat belt

The front-passenger front air bag is activated or deactivated depending on the person on the front-passenger seat. The front-passenger front air bag can only deploy in an accident if the PASSENGER AIR BAG OFF indicator lamp is off. Observe the information on the PASSENGER AIR BAG OFF indicator lamp (▷ page 51).

Your vehicle has two-stage front air bags. During the first deployment stage, the front air bag is filled with propellant gas to reduce the risk of injuries. The front air bag is fully deployed with the maximum amount of propellant gas if a second deployment threshold is reached within a few milliseconds.

The activation threshold of the Emergency Tensioning Devices and the air bag are determined by evaluating the rate of vehicle deceleration or acceleration which occurs at various points in the vehicle. This process is pre-emptive in nature. Deployment should take place in good time at the start of the collision. The rate of vehicle deceleration or acceleration and the direction of the force are essentially determined by:

- the distribution of forces during the collision
- the collision angle
- the deformation characteristics of the vehicle
- the characteristics of the object with which the vehicle has collided

Factors which can only be seen and measured after a collision has occurred do not play a decisive role in the deployment of an air bag. Nor do they provide an indication of air bag deployment.

The vehicle can be deformed considerably, without an air bag being deployed. This is the case if only parts which are relatively easily deformed are affected and the rate of deceleration is not high. Conversely, air bags may be deployed even though the vehicle suffers only minor deformation. This is the case if, for example, very rigid vehicle parts such as longitudinal body members are hit, and sufficient deceleration occurs as a result.

If the restraint system control unit detects a side impact or if the vehicle rolls over, the applicable components of the restraint system are activated independently of each other depending on the apparent type of accident.

- Side impact air bags on the side of impact, independently of the Emergency Tensioning Device and the use of the seat belt on the driver's seat and outer seats in the second row

The side impact air bag on the front-passenger side (front) deploys under the following conditions:

- the OCS system detects that the front-passenger seat is occupied or
- the belt tongue is engaged in the belt buckle of the front-passenger seat
- Window curtain air bag on the side of impact, independently of the use of the seat belt and independently of whether the front-passenger seat is occupied
- Emergency Tensioning Devices, if the system determines that deployment can offer additional protection in this situation
- Window curtain air bags on the driver's and front-passenger side in certain situations when the vehicle rolls over, if the system determines that deployment can offer additional protection to that provided by the seat belt

**i** Not all air bags are deployed in an accident. The different air bag systems work independently of each other.

How the air bag system works is determined by the severity of the accident detected, especially the vehicle deceleration or acceleration and the apparent type of accident:

- frontal collision
- side impact
- rollover

### PRE-SAFE® (anticipatory occupant protection system)

#### Introduction

In certain hazardous situations, PRE-SAFE® takes pre-emptive measures to protect the vehicle occupants.

#### Important safety notes

**!** Make sure that there are no objects in the footwell or behind the seats. There is a danger that the seats and/or objects could be damaged when PRE-SAFE® is activated.

Although your vehicle is equipped with PRE-SAFE®, the possibility of injury in the event of an accident cannot be ruled out. Always adapt your driving style to suit the prevailing road and weather conditions and maintain a safe distance from the vehicle in front. Drive carefully.

#### Function

PRE-SAFE® intervenes:

- in emergency braking situations, e.g. when BAS is activated
- in critical driving situations, e.g. when physical limits are exceeded and the vehicle understeers or oversteers severely
- on vehicles with the Driving Assistance package: if BAS PLUS intervenes powerfully or the radar sensor system detects an imminent danger of collision in certain situations

PRE-SAFE® takes the following measures depending on the hazardous situation detected:

- the front seat belts are pre-tensioned.
- if the vehicle skids, the sliding sunroof and the side windows are closed so that only a small gap remains. The panorama roof with power tilt/sliding panel is completely closed.
- vehicles with the memory function: the front-passenger seat is adjusted if it is in an unfavorable position.
- vehicles with a multicontour seat: the air pressure in the side bolsters of the seat backrest is increased.

If the hazardous situation passes without resulting in an accident, PRE-SAFE® slackens the belt pre-tensioning. On vehicles with multicontour seats, the air pressure in the side bolsters is reduced again. All settings made by PRE-SAFE® can then be reversed.

If the seat belt pre-tensioning is not reduced:

- ▶ Move the seat backrest or seat back slightly when the vehicle is stationary. The seat belt pre-tensioning is reduced and the locking mechanism is released.

The seat-belt adjustment is an integral part of the PRE-SAFE® convenience function. You will find information on the convenience function under "Belt adjustment" (▷ page 55).

#### Automatic measures after an accident

Immediately after an accident, the following measures are implemented, depending on the type and severity of the impact:

- the hazard warning lamps are activated
- the emergency lighting is activated
- the vehicle doors are unlocked
- the front side windows are lowered
- vehicles with a memory function: the electrically adjustable steering wheel is raised

- the engine is switched off and the fuel supply is cut off
- vehicles with mbrace: automatic emergency call

## Children in the vehicle

### Important safety notes

Accident statistics show that children secured in the rear seats are safer than children secured in the front-passenger seat. For this reason, Mercedes-Benz strongly advises that you install a child restraint system on a rear seat. Children are generally better protected there.

If a child younger than twelve years old and under 5 ft (1.50 m) in height is traveling in the vehicle:

- always secure the child in a child restraint system suitable for Mercedes-Benz vehicles. The child restraint system must be appropriate to the age, weight and size of the child
- be sure to observe the instructions and safety notes in this section in addition to the child restraint system manufacturer's installation instructions
- be sure to observe the instructions and safety notes on the "Occupant classification system (OCS)" (▷ page 59)

### WARNING

If you leave children unsupervised in the vehicle, they could set it in motion by, for example:

- release the parking brake.
- shift the automatic transmission out of the parking position **P**.
- start the engine.

In addition, they may operate vehicle equipment and become trapped. There is a risk of an accident and injury.

When leaving the vehicle, always take the SmartKey with you and lock the vehicle. Never leave children unsupervised in the vehicle.

### WARNING

If persons, particularly children are subjected to prolonged exposure to extreme heat or cold, there is a risk of injury, possibly even fatal. Never leave children unattended in the vehicle.

### WARNING

If the child restraint system is subjected to direct sunlight, parts may get very hot. Children may burn themselves on these parts, particularly on the metal parts of the child restraint system. There is a risk of injury.

If you leave the vehicle, taking the child with you, always ensure that the child restraint system is not exposed to direct sunlight. Protect it with a blanket, for example. If the child restraint system has been exposed to direct sunlight, let it cool down before securing the child in it. Never leave children unattended in the vehicle.

Always ensure that all vehicle occupants have their seat belts fastened correctly and are sitting properly. Particular attention must be paid to children.

Observe the safety notes on the seat belt (▷ page 52) and the notes on correct use of seat belts (▷ page 53).

A booster seat may be necessary to achieve proper seat belt positioning for children over 41 lbs (18 kg) until they reach a height where a three-point seat belt can be properly fastened without a booster seat.

### Special seat belt retractor

### WARNING

If the seat belt is released while driving, the child restraint system will no longer be secured properly. The special seat belt retractor is disabled and the inertia reel draws in a portion of the seat belt. The seat belt cannot be immediately refastened. There is an increased risk of injury, possibly even fatal.

Stop the vehicle immediately, paying attention to road and traffic conditions. Reactivate the special seat belt retractor and secure the child restraint system properly.

All seat belts in the vehicle, except the driver's seat belt, are equipped with a special seat belt retractor. When activated, the special seat belt retractor ensures that the seat belt cannot slacken once the child seat is secured.

Installing a child restraint system:

- ▶ Make sure you observe the child restraint system manufacturer's installation instructions.
- ▶ Pull the seat belt smoothly from the belt outlet.
- ▶ Engage seat belt tongue in belt buckle.

Activating the special seat belt retractor:

- ▶ Pull the seat belt out fully and let the inertia reel retract it again.  
While the seat belt is retracting, you should hear a ratcheting sound. The special seat belt retractor is enabled.
- ▶ Push the child restraint system down so that the seat belt is tight and does not loosen.

Removing the child restraint system and deactivating the special seat belt retractor:

- ▶ Make sure you observe the child restraint system manufacturer's installation instructions.
- ▶ Press the release button of the seat belt buckle and guide the seat belt tongue back towards the belt sash guide.  
The special seat belt retractor is deactivated.

### Child restraint system

The use of seat belts and child restraint systems is required by law in:

- all 50 states
- the U.S. territories

- the District of Columbia
- all Canadian provinces

If you install a rearward-facing child restraint system on the center rear seat, the rear arm rest must be folded back as far as possible.

You can obtain further information about the correct child restraint system from any authorized Mercedes-Benz Center.

#### WARNING

If the child restraint system is installed incorrectly on a suitable seat, it cannot protect as intended. The child cannot then be restrained in the event of an accident, heavy braking or sudden changes of direction. There is an increased risk of injury, possibly even fatal.

Make sure that you observe the child restraint system manufacturer's installation instructions and the notes on use. Please ensure, that the base of the child restraint system is always resting completely on the seat cushion. Never place objects, e.g. cushions, under or behind the child restraint system. Only use child restraint systems with the original cover designed for them. Only replace damaged covers with genuine covers.

#### WARNING

If the child restraint system is installed incorrectly or is not secured, it can come loose in the event of an accident, heavy braking or a sudden change in direction. The child restraint system could be thrown about, striking vehicle occupants. There is an increased risk of injury, possibly even fatal.

Always install child restraint systems properly, even if they are not being used. Make sure that you observe the child restraint system manufacturer's installation instructions.

You will find further information on stowing objects, luggage or loads under "Loading guidelines" (> page 248).

#### WARNING

Child restraint systems or their securing systems which have been damaged or subjected

to a load in an accident can no longer protect as intended. The child cannot then be restrained in the event of an accident, heavy braking or sudden changes of direction. There is an increased risk of injury, possibly even fatal.

Replace child restraint systems which have been damaged or subjected to a load in an accident as soon as possible. Have the securing systems on the child restraint system checked at a qualified specialist workshop, before you install a child restraint system again.

The securing systems of child restraint systems are:

- the seat belt system
- the LATCH-type (ISOFIX) securing rings
- the Top Tether anchorages

If it is absolutely necessary to carry a child on the front-passenger seat, be sure to observe the information on the "Occupant Classification System (OCS)" (> page 59). There you will also find information on deactivating the front-passenger front air bag.

All child restraint systems must meet the following standards:

- U.S. Federal Motor Vehicle Safety Standards 213 and 225
- Canadian Motor Vehicle Safety Standards 213 and 210.2

Confirmation that the child restraint system corresponds to the standards can be found on an instruction label on the child restraint system. This confirmation can also be found in the installation instructions that are included with the child restraint system.

Observe the warning labels in the vehicle interior and on the child restraint system.

### LATCH-type (ISOFIX) child seat securing system

#### WARNING

LATCH-type (ISOFIX) child restraint systems do not offer sufficient protective effect for children whose weight is greater than 48 lbs (22 kg) who are secured using the safety belt integrated in the child restraint system. In the event of an accident, a child might not be restrained correctly. This poses an increased risk of injury or even fatal injury.

If the child weighs more than 48 lbs (22 kg), only use LATCH-type (ISOFIX) child restraint systems with which the child is also secured with the vehicle seat belt. Also secure the child restraint system with the Top Tether belt, if available.

Always comply with the manufacturer's installation and operating instructions for the child restraint system used.

Before every trip, make sure that the LATCH-type (ISOFIX) child restraint system is engaged correctly in both LATCH-type (ISOFIX) securing rings

To ensure that the LATCH-type (ISOFIX) child restraint system can perform its protective function as intended, the backrest of the respective outer seat in the second row must be in the upright position.

 When installing the child restraint system, make sure that the seat belt for the middle seat does not get trapped. The seat belt could otherwise be damaged.

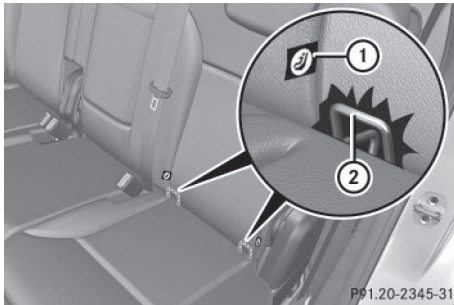

LATCH-type (ISOFIX) securing rings for the outer seat in the second row of seats

Installation indicator ① shows the installation location of LATCH-type (ISOFIX) securing rings ②.

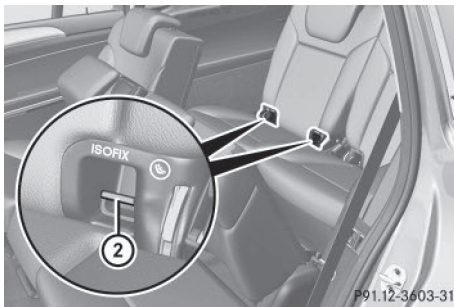

LATCH-type (ISOFIX) securing rings for the third row of seats

LATCH-type (ISOFIX) securing rings ② for two LATCH-type (ISOFIX) child restraint systems are installed on the left and right:

- on the rear seat backrests of the outer seats in the second row
- on the backrests of the seats in the third row of seats

Before installing a LATCH-type (ISOFIX) child restraint system on the second row of seats:

- ▶ Move the rear seat backrests in the second row to an upright position (▷ page 110).
- ▶ Install the LATCH-type (ISOFIX) child restraint system on both LATCH-type (ISOFIX) securing rings ②.

ISOFIX is a standardized securing system for specially designed child restraint systems on the rear seats.

Non-LATCH-type (ISOFIX) child seats may also be used and can be installed using the vehicle's seat belt system. Install the child seat according to the manufacturer's instructions.

## Top Tether

### Introduction

Top Tether provides an additional connection between the child restraint system secured with a LATCH-type (ISOFIX) child seat mount and the vehicle. This helps reduce the risk of injury even further. If the child restraint system is equipped with a Top Tether belt, this should always be used.

### Important safety notes

#### WARNING

If the rear seats or the rear seat backrests are not locked, they could fold forwards in the event of an accident, heavy braking or sudden changes of direction. As a result, child restraint systems cannot perform their intended protective function. Rear seats and rear seat backrests that are not locked can also cause additional injuries, e.g. in the event of an accident. This poses an increased risk of injury or even fatal injury.

Always lock the rear seats and rear seat backrests after installing a Top Tether belt. Observe the lock verification indicator. Adjust the rear seat backrests so that they are in an upright position.

If the rear seat backrest is not engaged and locked, this will be shown in the multifunction display in the instrument cluster.



## Top Tether anchorages

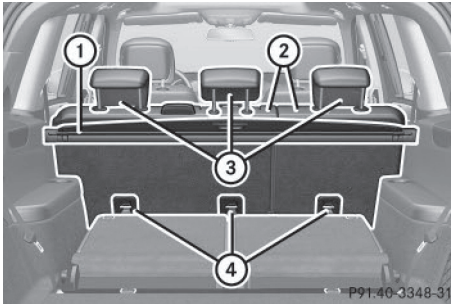

The Top Tether anchorages for the second row of seats are located on the rear of the rear seat backrests. For the third row of seats, use the cargo tie-down rings in the cargo compartment floor.

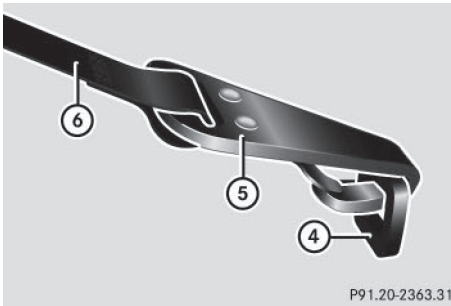

- ▶ Move head restraint ③ upwards.
- ▶ Install the LATCH-type (ISOFIX) child restraint system with Top Tether. Always comply with the child restraint system manufacturer's installation instructions when doing so.
- ▶ Route Top Tether belt ⑥ under head restraint ③ between the two head restraint bars.
- ▶ Guide Top Tether belt ⑥ downwards between cargo compartment cover ① and rear seat backrest ②.
- ▶ Hook Top Tether hook ⑤ of Top Tether belt ⑥ into Top Tether anchorage ④.

Make sure that:

- Top Tether hook ⑤ is hooked into Top Tether anchorage ④ as shown.
  - Top Tether belt ⑥ is not twisted.
  - Top Tether belt ⑥ is routed between rear seat backrest ② and cargo compartment cover ① if cargo compartment cover ① is installed.
  - Top Tether belt ⑥ is routed between the rear seat backrest ② and the cargo net if the cargo net is installed.
- ▶ Tension Top Tether belt ⑥. Always comply with the child restraint system manufacturer's installation instructions when doing so.
  - ▶ Move head restraint ③ back down again slightly if necessary (▶ page 110). Make sure that you do not interfere with the correct routing of Top Tether belt ⑥.

## Child restraint system on the front-passenger seat

### General notes

Accident statistics show that children secured in the rear seats are safer than children secured in the front-passenger seat. For this reason, Mercedes-Benz strongly advises that you install the child restraint system on a rear seat.

If it is absolutely necessary to install a child restraint system on the front-passenger seat, be sure to observe the instructions and safety notes on the "Occupant Classification System (OCS)" (▶ page 59).

You can thus avoid the risks that could arise as a result of:

- an incorrectly categorized person in the front-passenger seat
- the unintentional deactivation of the front-passenger front air bag
- the unsuitable positioning of the child restraint system, e.g. too close to the dashboard

### **Rearward-facing child restraint system**

If it is absolutely necessary to install a rearward-facing child restraint system on the front-passenger seat, always make sure that the front-passenger front air bag is deactivated. Only if the PASSENGER AIR BAG OFF indicator lamp is permanently lit (▷ page 51) is the front-passenger front air bag deactivated.

Always observe the child restraint system manufacturer's installation and operating instructions.

### **Forward-facing child restraint system**

If it is absolutely necessary to install a forward-facing child restraint system on the front-passenger seat, always move the front-passenger seat as far back as possible. The entire base of the child restraint system must always rest on the seat cushion of the front-passenger seat. The backrest of the child restraint system must lie as flat as possible against the backrest of the front-passenger seat. The child restraint system must not touch the roof or be subjected to a load by the head restraint. Adjust the angle of the seat backrest and the head restraint position accordingly. Always make sure that the shoulder belt strap is correctly routed from the vehicle belt outlet to the shoulder belt guide on the child restraint system. The shoulder belt strap must be routed forwards and downwards from the vehicle belt outlet. If necessary, adjust the vehicle belt outlet and the front-passenger seat accordingly.

Always observe the child restraint system manufacturer's installation and operating instructions.

### **Child-proof locks**

#### **Important safety notes**

##### **WARNING**

If children are traveling in the vehicle, they could:

- open doors, thus endangering other people or road users
- exit the vehicle and be caught by oncoming traffic
- operate vehicle equipment and become trapped

There is a risk of an accident and injury.

Always activate the child-proof locks and override feature if children are traveling in the vehicle. When leaving the vehicle, always take the key with you and lock the vehicle. Never leave children unattended in the vehicle.

Override feature for:

- the rear doors (▷ page 73)
- the rear side windows (▷ page 73)

##### **WARNING**

If you leave children unsupervised in the vehicle, they could set it in motion by, for example:

- release the parking brake.
- shift the automatic transmission out of the parking position **P**.
- start the engine.

In addition, they may operate vehicle equipment and become trapped. There is a risk of an accident and injury.

When leaving the vehicle, always take the SmartKey with you and lock the vehicle. Never leave children unsupervised in the vehicle.

##### **WARNING**

If persons, particularly children are subjected to prolonged exposure to extreme heat or cold, there is a risk of injury, possibly even fatal. Never leave children unattended in the vehicle.



**⚠ WARNING**

If the child restraint system is subjected to direct sunlight, parts may get very hot. Children may burn themselves on these parts, particularly on the metal parts of the child restraint system. There is a risk of injury.

If you leave the vehicle, taking the child with you, always ensure that the child restraint system is not exposed to direct sunlight. Protect it with a blanket, for example. If the child restraint system has been exposed to direct sunlight, let it cool down before securing the child in it. Never leave children unattended in the vehicle.

**Child-proof locks for the rear doors**

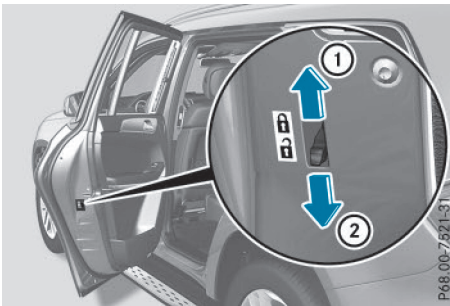

You secure each door individually with the child-proof locks on the rear doors. A door secured with a child-proof lock cannot be opened from inside the vehicle. When the vehicle is unlocked, the door can be opened from the outside.

- ▶ **To activate:** press the child-proof lock lever up in the direction of arrow ①.
- ▶ Make sure that the child-proof locks are working properly.
- ▶ **To deactivate:** press the child-proof lock lever down in the direction of arrow ②.

**Override feature for the rear side windows**

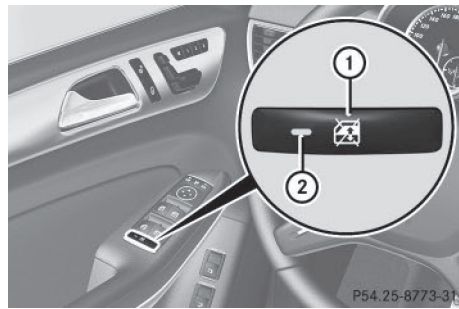

- ▶ **To activate/deactivate:** press button ①. If indicator lamp ② is lit, operation of the rear side windows is disabled. Operation is only possible using the switches in the driver's door. If indicator lamp ② is off, operation is possible using the switches in the rear compartment.

**Pets in the vehicle**

**⚠ WARNING**

If you leave animals unattended or unsecured in the vehicle, they could press buttons or switches, for example.

As a result, they could:

- activate vehicle equipment and become trapped, for example
- activate or deactivate systems, thereby endangering other road users

Unsecured animals could also be flung around the vehicle in the event of an accident or sudden steering or braking, thereby injuring vehicle occupants. There is a risk of an accident and injury.

Never leave animals unattended in the vehicle. Always secure animals properly during the journey, e.g. use a suitable animal transport box.

## Driving safety systems

### Overview of driving safety systems

In this section, you will find information about the following driving safety systems:

- **ABS (Anti-lock Braking System)**  
(▷ page 74)
- **BAS (Brake Assist System)** (▷ page 75)
- **BAS PLUS (Brake Assist System Plus)**  
(▷ page 75)
- **COLLISION PREVENTION ASSIST PLUS**  
(distance warning function and Adaptive Brake Assist) (▷ page 76)
- **ESP® (Electronic Stability Program)**  
(▷ page 79)
- **EBD (Electronic Brake force Distribution)**  
(▷ page 81)
- **ADAPTIVE BRAKE** (▷ page 82)
- **PRE-SAFE® Brake** (▷ page 82)
- **STEER CONTROL** (▷ page 83)

### Important safety notes

If you fail to adapt your driving style or if you are inattentive, the driving safety systems can neither reduce the risk of an accident nor override the laws of physics. Driving safety systems are merely aids designed to assist driving. You are responsible for maintaining the distance to the vehicle in front, for vehicle speed, for braking in good time, and for staying in lane. Always adapt your driving style to suit the prevailing road and weather conditions and maintain a safe distance from the vehicle in front. Drive carefully.

The driving safety systems described only work as effectively as possible when there is adequate contact between the tires and the road surface. Pay particular attention to the information regarding tires, recommended minimum tire tread depths etc. in the "Wheels and tires" section (▷ page 292).

In wintry driving conditions, always use winter tires (M+S tires) and if necessary, snow

chains. Only in this way will the driving safety systems described in this section work as effectively as possible.

### ABS (Anti-lock Braking System)

#### General information

ABS regulates brake pressure in such a way that the wheels do not lock when you brake. This allows you to continue steering the vehicle when braking.

The  ABS warning lamp in the instrument cluster lights up when the ignition is switched on. It goes out when the engine is running.

ABS works from a speed of about 5 mph (8 km/h), regardless of road-surface conditions. ABS works on slippery surfaces, even when you only brake gently.

#### Important safety notes

- i** Observe the "Important safety notes" section (▷ page 74).

#### **WARNING**

If ABS is faulty, the wheels could lock when braking. The steerability and braking characteristics may be severely impaired. Additionally, further driving safety systems are deactivated. There is an increased danger of skidding and accidents.

Drive on carefully. Have ABS checked immediately at a qualified specialist workshop.

When ABS is malfunctioning, other systems, including driving safety systems, will also become inoperative. Observe the information on the ABS warning lamp (▷ page 217) and display messages which may be shown in the instrument cluster (▷ page 202).

## Braking

- ▶ **If ABS intervenes:** continue to depress the brake pedal vigorously until the braking situation is over.
- ▶ **To make a full brake application:** depress the brake pedal with full force.

If ABS intervenes when braking, you will feel a pulsing in the brake pedal.

The pulsating brake pedal can be an indication of hazardous road conditions, and functions as a reminder to take extra care while driving.

## Off-road ABS

A 4ETS system specifically suited to off-road terrain is activated automatically once the off-road program is activated (▷ page 188).

At speeds below 20 mph (30 km/h), the front wheels lock cyclically during braking. The digging-in effect achieved in the process reduces the stopping distance on off-road terrain. This limits steering capability.

## BAS (Brake Assist System)

### General information

BAS operates in emergency braking situations. If you depress the brake pedal quickly, BAS automatically boosts the braking force, thus shortening the stopping distance.

### Important safety notes

- ❗ Observe the "Important safety notes" section (▷ page 74).

#### WARNING

If BAS is malfunctioning, the braking distance in an emergency braking situation is increased. There is a risk of an accident.

In an emergency braking situation, depress the brake pedal with full force. ABS prevents the wheels from locking.

## Braking

- ▶ Keep the brake pedal firmly depressed until the emergency braking situation is over. ABS prevents the wheels from locking.

The brakes will function as usual once you release the brake pedal. BAS is deactivated.

## BAS PLUS (Brake Assist System PLUS)

### General information

BAS PLUS can help you to minimize the risk of a collision with a vehicle or reduce the effects of such a collision. If BAS PLUS detects a danger of collision, you are assisted when braking.

- ❗ Observe the "Important safety notes" section (▷ page 74).

BAS PLUS is only available in vehicles equipped with DISTRONIC PLUS.

For BAS PLUS to assist you, the radar sensor system must be operational.

With the help of the radar sensor system, BAS PLUS can detect obstacles that are in the path of your vehicle for an extended period of time.

If the radar sensor system is malfunctioning, BAS PLUS will not be available. The brake system is still available with complete brake boosting effect and BAS.

### Important safety notes

#### WARNING

BAS PLUS cannot always clearly identify objects and complex traffic situations.

In such cases, BAS PLUS may:

- intervene unnecessarily
- not intervene

There is a risk of an accident.

Always pay careful attention to the traffic situation and be ready to brake. Terminate the intervention in a non-critical driving situation.

**⚠ WARNING**

BAS PLUS does not react:

- to people or animals
- to oncoming vehicles
- to crossing traffic
- when cornering

As a result, BAS PLUS may not intervene in all critical situations. There is a risk of an accident.

Always pay careful attention to the traffic situation and be ready to brake.

In the event of snowfall or heavy rain, the recognition can be impaired.

Recognition by the radar sensor system is also impaired in the event of:

- there is dirt on the sensors or anything else covering the sensors
- there is interference by other radar sources
- there are strong radar reflections, for example in parking garages
- a narrow vehicle traveling in front, e.g. a motorbike
- a vehicle traveling in front on a different line relative to the center of your vehicle

Following damage to the front end of the vehicle, have the configuration and operation of the radar sensors checked at a qualified specialist workshop. This also applies to collisions at low speeds where there is no visible damage to the front of the vehicle.

**Function**

To avoid a collision, BAS PLUS calculates the brake force necessary if:

- you approach an obstacle, and
- BAS PLUS has detected a risk of collision

**When driving at a speed under 20 mph (30 km/h):** if you depress the brake pedal, BAS PLUS is activated. The increase in brake pressure will be carried out at the last possible moment.

**When driving at a speed above 20 mph (30 km/h):** if you depress the brake pedal sharply, BAS PLUS automatically raises the brake pressure to a value adapted to the traffic situation.

BAS PLUS provides braking assistance in hazardous situations with vehicles in front within a speed range between 4 mph (7 km/h) and 155 mph (250 km/h).

At speeds of up to approximately 40 mph (70 km/h), BAS PLUS can also react to stationary objects. Examples of stationary objects are stopped or parked vehicles.

**i** If BAS PLUS demands particularly high braking force, preventative passenger protection measures (PRE-SAFE®) are activated simultaneously.

- ▶ Keep the brake pedal depressed until the emergency braking situation is over. ABS prevents the wheels from locking.

BAS PLUS is deactivated and the brakes function as usual again, if:

- you release the brake pedal.
- there is no longer a risk of collision.
- no obstacle is detected in front of your vehicle.

If you have activated DSR (▷ page 187), BAS PLUS is likewise deactivated.

**COLLISION PREVENTION ASSIST****General notes**

COLLISION PREVENTION ASSIST consists of Adaptive Brake Assist and the distance warning function, which are described in the following.

**Distance warning function****Important safety notes**

**i** Observe the "Important safety notes" section (▷ page 74).

**⚠ WARNING**

The distance warning function does not react:

- to people or animals
- to oncoming vehicles
- to crossing traffic
- when cornering

Thus, the distance warning function cannot provide a warning in all critical situations. There is a risk of an accident.

Always pay careful attention to the traffic situation and be ready to brake.

**⚠ WARNING**

The distance warning function cannot always clearly identify objects and complex traffic situations.

In such cases, the distance warning function may:

- give an unnecessary warning
- not give a warning

There is a risk of an accident.

Always pay careful attention to the traffic situation and do not rely solely on the distance warning function.

**Function**

► **To activate/deactivate:** activate or deactivate the distance warning function in the on-board computer (▷ page 199).

If the distance warning function is not activated, the  symbol appears in the assistance graphics display.

The distance warning function can help you to minimize the risk of a front-end collision with a vehicle ahead or reduce the effects of such a collision. If the distance warning function detects that there is a risk of a collision, you will be warned visually and acoustically. The distance warning function cannot prevent a collision without your intervention.

Starting at a speed of around 4 mph (7 km/h), the distance warning function warns you if you rapidly approach a vehicle in front. An intermittent warning tone will then sound,

and the  distance warning lamp will light up in the instrument cluster.

► Brake immediately in order to increase the distance from the vehicle in front.

or

► Take evasive action, provided it is safe to do so.

Due to the nature of the system, particularly complicated but non-critical driving conditions may also cause the system to display a warning.

With the help of the radar sensor system, the distance warning function can detect obstacles that are in the path of your vehicle for an extended period of time.

Up to a speed of around 40 mph (70 km/h), the distance warning function can also react to stationary obstacles, such as stopped or parked vehicles.

If you approach an obstacle and the distance warning function detects a risk of a collision, the system will initially alert you both visually and acoustically.

In particular, the detection of obstacles can be impaired if:

- there is dirt on the sensors or anything else covering the sensors
- there is snow or heavy rain
- there is interference by other radar sources
- there are strong radar reflections, for example in parking garages
- a narrow vehicle traveling in front, e.g. a motorbike
- a vehicle traveling in front on a different line
- new vehicles or after the COLLISION PREVENTION ASSIST system has been serviced

Observe the notes in the section on breaking-in (▷ page 134).

Following damage to the front end of the vehicle, have the configuration and operation of the radar sensor checked at a qualified specialist workshop. This also applies to colli-

sions at low speeds where there is no visible damage to the front of the vehicle.

### Adaptive Brake Assist

**i** Observe the "Important safety notes" section (> page 74).

Adaptive Brake Assist provides braking assistance in hazardous situations at speeds above 4 mph (7 km/h). It uses radar sensor technology to assess the traffic situation.

#### WARNING

Adaptive Brake Assist cannot always clearly identify objects and complex traffic situations.

In such cases, Adaptive Brake Assist can:

- intervene unnecessarily
- not intervene

There is a risk of an accident.

Always pay careful attention to the traffic situation and be ready to brake. Terminate the intervention in a non-critical driving situation.

#### WARNING

Adaptive Brake Assist does not react:

- to people or animals
- to oncoming vehicles
- to crossing traffic
- to stationary obstacles
- when cornering

As a result, the Adaptive Brake Assist may not intervene in all critical conditions. There is a risk of an accident.

Always pay careful attention to the traffic situation and be ready to brake.

Due to the nature of the system, particularly complicated but non-critical driving conditions may also cause Brake Assist to intervene.

With the help of Adaptive Brake Assist, the distance warning signal can detect obstacles that are in the path of your vehicle for an extended period of time.

If adaptive Brake Assist has detected that there is a risk of a collision, it calculates the braking force necessary to avoid a collision. Should you apply the brakes vigorously, Adaptive Brake Assist will automatically increase the braking force to a level suitable for the traffic conditions.

- ▶ Keep the brake pedal depressed until the emergency braking situation is over. ABS prevents the wheels from locking.

The brakes will work normally again if:

- you release the brake pedal.
- there is no longer any danger of a collision.
- no obstacle is detected in front of your vehicle.

Adaptive Brake Assist is then deactivated.

**Vehicles with PRE-SAFE®:** if adaptive Brake Assist requires particularly high brake pressure, preventive passenger protection measures (PRE-SAFE®) are deployed simultaneously.

Up to vehicle speeds of around 155 mph (250 km/h), adaptive Brake Assist is capable of reacting to moving objects that have already been recognized as such at least once over the period of observation. Adaptive Brake Assist does not react to stationary obstacles.

If Adaptive Brake Assist is not available due to a malfunction in the radar sensor system, the brake system remains available with full brake boosting effect and BAS.

In particular, the detection of obstacles can be impaired if there is:

- there is dirt on the sensors or anything else covering the sensors
- there is snow or heavy rain
- there is interference by other radar sources
- there are strong radar reflections, for example in parking garages
- a narrow vehicle traveling in front, e.g. a motorbike

- a vehicle traveling in front on a different line relative to the center of your vehicle
- new vehicles or after the COLLISION PREVENTION ASSIST system has been serviced

Observe the notes in the section on breaking-in (▷ page 134).

Following damage to the front end of the vehicle, have the configuration and operation of the radar sensor checked at a qualified specialist workshop. This also applies to collisions at low speeds where there is no visible damage to the front of the vehicle.

### ESP® (Electronic Stability Program)

#### General notes

- i** Observe the "Important safety notes" section (▷ page 74).

ESP® monitors driving stability and traction, i.e. power transmission between the tires and the road surface.

If ESP® detects that the vehicle is deviating from the direction desired by the driver, one or more wheels are braked to stabilize the vehicle. The engine output is also modified to keep the vehicle on the desired course within physical limits. ESP® assists the driver when pulling away on wet or slippery roads. ESP® can also stabilize the vehicle during braking.

### ETS/4ETS (Electronic Traction System)

- i** Observe the "Important safety notes" section (▷ page 74).

4ETS traction control is part of ESP®.

Traction control brakes the drive wheels individually if they spin. This enables you to pull away and accelerate on slippery surfaces, for example if the road surface is slippery on one side. In addition, more drive torque is transferred to the wheel or wheels with traction.

Traction control remains active, even if you deactivate ESP®.

In appropriate driving situations, activate the off-road program (▷ page 188).

### Off-road 4ETS (Electronic Traction System)

A 4ETS system specifically suited to off-road terrain is activated automatically once the off-road program is activated (▷ page 188).

#### Important safety notes

##### WARNING

If ESP® is malfunctioning, ESP® is unable to stabilize the vehicle. Additionally, further driving safety systems are deactivated. This increases the risk of skidding and an accident.



Drive on carefully. Have ESP® checked at a qualified specialist workshop.

- !** Only operate the vehicle for a maximum of ten seconds on a brake test dynamometer. Switch off the ignition.

Application of the brakes by ESP® may otherwise destroy the brake system.

- !** A function or performance test should only be carried out on a two-axle dynamometer. Before you operate the vehicle on such a dynamometer, please consult a qualified workshop. You could otherwise damage the drive train or the brake system.

ESP® is only deactivated if the  warning lamp is lit continuously.

If the  warning lamp and the  warning lamp are lit continuously, ESP® is not available due to a malfunction.

Observe the information on warning lamps (▷ page 220) and display messages which may be shown in the instrument cluster (▷ page 202).

- i** Only use wheels with the recommended tire sizes. Only then will ESP® function properly.



## Characteristics of ESP®

### General information

If the  ESP warning lamp goes out before beginning the journey, ESP® is automatically active.

If ESP® intervenes, the  ESP® warning lamp flashes in the instrument cluster.

If ESP® intervenes:

- ▶ Do not deactivate ESP® under any circumstances.
- ▶ Only depress the accelerator pedal as far as necessary when pulling away.
- ▶ Adapt your driving style to suit the prevailing road and weather conditions.

### ECO start/stop function

The ECO start/stop function switches the engine off automatically when the vehicle stops moving. The engine starts automatically when the driver wants to pull away again. ESP® remains in its previously selected status. **Example:** if ESP® was deactivated before the engine was switched off, ESP® remains deactivated when the engine is switched on again.

## Deactivating/activating ESP®

### Important safety notes

- ❗ Observe the "Important safety notes" section (▷ page 74).

You can select between the following states of ESP®:

- ESP® is activated.
- ESP® is deactivated.

### WARNING

If you deactivate ESP®, ESP® no longer stabilizes the vehicle. There is an increased risk of skidding and an accident.

Only deactivate ESP® in the situations described in the following.

It may be best to deactivate ESP® in the following situations:

- when using snow chains
  - in deep snow
  - on sand or gravel
- ❗ Activate ESP® as soon as the situations described above no longer apply. ESP® will otherwise not be able to stabilize the vehicle if the vehicle starts to skid or a wheel starts to spin.
  - ❗ Avoid spinning the driven wheels for an extended period with ESP® deactivated. You could otherwise damage the drivetrain.

### Deactivating/activating ESP®

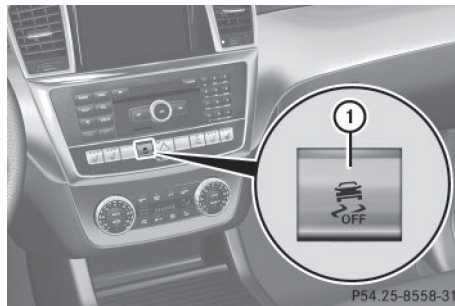

- ▶ **To deactivate:** press button ①.

The  ESP® OFF warning lamp in the instrument cluster lights up.

- ▶ **To activate:** press button ①.

The  ESP® OFF warning lamp in the instrument cluster goes out.

### Characteristics when ESP® is deactivated

If ESP® is deactivated and one or more wheels start to spin, the  ESP® warning lamp in the instrument cluster flashes. In such situations, ESP® will not stabilize the vehicle.

If you deactivate ESP®:

- ESP® no longer improves driving stability.
- engine torque is no longer limited and the drive wheels are able to spin.



The spinning of the wheels results in a cutting action for better traction on loose surfaces.

- traction control is still activated.
- ESP® still provides support when you brake.

### Off-road ESP® (vehicles with ON&OFF-ROAD package)

An ESP® system specifically suited to off-road terrain is activated automatically once the off-road program is activated (▷ page 188).

Off-road ESP® intervenes with a delay if there is oversteering or understeering, thus improving traction.

### ESP® trailer stabilization

#### General information

If your vehicle/trailer combination begins to swerve, ESP® assists you in this situation. ESP® slows the vehicle down by braking and limiting the engine output until the vehicle/trailer combination has stabilized.

#### Important safety notes

##### WARNING

If road and weather conditions are poor, trailer stabilization will not be able to prevent the vehicle/trailer combination from swerving. Trailers with a high center of gravity can tip over before ESP® can detect this. There is a risk of an accident.

Always adapt your driving style to the prevailing road and weather conditions.

If your vehicle with trailer (vehicle/trailer combination) begins to lurch, you can only stabilize the vehicle/trailer combination by depressing the brake firmly. Trailer stabilization is active above speeds of about 37 mph (60 km/h).

ESP® trailer stabilization does not work if ESP® is deactivated or disabled because of a malfunction.

### Crosswind Assist

#### General information

Strong crosswinds can cause your vehicle to deviate from a straight course. The crosswind driving assistance function integrated into ESP® significantly reduces these effects.

ESP® intervenes automatically according to the direction and intensity of the crosswinds affecting your vehicle.

ESP intervenes with stabilizing braking to assist you in keeping the vehicle in the lane.

Crosswind Assist is active at vehicle speeds above 50 mph (80 km/h) when driving straight ahead or cornering gently.

#### Important safety notes

Crosswind Assist does not work if ESP® is deactivated or disabled because of a malfunction.

### EBD (electronic brake force distribution)

#### General information

EBD monitors and controls the brake pressure on the rear wheels to improve driving stability while braking.

#### Important safety notes

-  Observe the "Important safety notes" section for driving safety systems (▷ page 74).

##### WARNING

If EBD is malfunctioning, the rear wheels can lock, e.g. under full braking. This increases the risk of skidding and an accident.

You should therefore adapt your driving style to the different handling characteristics. Have the brake system checked at a qualified specialist workshop.

Observe information regarding indicator and warning lamps (▷ page 217) as well as display messages (▷ page 204).

## ADAPTIVE BRAKE

ADAPTIVE BRAKE enhances braking safety and offers increased braking comfort. In addition to the braking function, ADAPTIVE BRAKE also has the HOLD function (▷ page 164) and hill start assist (▷ page 139).

## PRE-SAFE® Brake

### General information

PRE-SAFE® Brake can help you to minimize the risk of a collision with a vehicle ahead, and reduce the effects of such a collision. If PRE-SAFE® Brake has detected a risk of collision, you will be warned visually and acoustically as well as by automatic braking. PRE-SAFE® Brake cannot prevent a collision without your intervention.

- i** Pay attention to the important safety notes in the "Driving safety systems" section (▷ page 74).

PRE-SAFE® Brake is only available for vehicles with the Driving Assistance package.

For PRE-SAFE® Brake to assist you when driving, the radar sensor system must be operational.

With the help of the radar sensor system, PRE-SAFE® Brake can detect obstacles that are in front of your vehicle for an extended period of time.

### Important safety notes

#### WARNING

PRE-SAFE® Brake will initially brake your vehicle by a partial application of the brakes if a danger of collision is detected. There may be a collision unless you also brake. Automatic emergency braking cannot prevent a collision. There is a risk of an accident.

Always apply the brakes yourself and try to take evasive action.

In the event of a partial application of the brakes, the vehicle is braked with up to 50% of the full braking pressure.

#### WARNING

PRE-SAFE® Brake cannot always clearly identify objects and complex traffic conditions.

In these cases, PRE-SAFE® Brake may:

- give an unnecessary warning and then brake the vehicle
- not give a warning or intervene

There is a risk of an accident.

Always pay particular attention to the traffic situation and be ready to brake, especially if PRE-SAFE® Brake warns you. Terminate the intervention in a non-critical driving situation.

In order to maintain the appropriate distance to the vehicle in front and thus prevent a collision, you must apply the brakes yourself.

At speeds of up to approximately 40 mph (70 km/h) PRE-SAFE® Brake can also detect stationary objects. Examples of stationary objects are stopped or parked vehicles.

#### WARNING

PRE-SAFE® Brake does not react:

- to people or animals
- to oncoming vehicles
- to crossing traffic
- when cornering

As a result, PRE-SAFE® Brake may neither give warnings nor intervene in all critical situations. There is a risk of an accident.

Always pay careful attention to the traffic situation and be ready to brake.

In the event of snowfall or heavy rain, the recognition can be impaired.

Recognition by the radar sensor system is also impaired in the event of:

- there is dirt on the sensors or anything else covering the sensors
- there is interference by other radar sources

- there are strong radar reflections, for example in parking garages
- a narrow vehicle traveling in front, e.g. a motorbike
- a vehicle traveling in front on a different line relative to the center of your vehicle

Following damage to the front end of the vehicle, have the configuration and operation of the radar sensors checked at a qualified specialist workshop. This also applies to collisions at low speeds where there is no visible damage to the front of the vehicle.

### Function

► **To activate/deactivate:** activate or deactivate PRE-SAFE® Brake in the on-board computer (▷ page 199).

If the PRE-SAFE® Brake is not activated, the  symbol appears in the multifunction display.

If you have activated DSR (▷ page 187), PRE-SAFE® Brake is deactivated.

Starting at a speed of around 4 mph (7 km/h), this function warns you if you rapidly approach a vehicle in front. An intermittent warning tone will then sound and the  distance warning lamp will light up in the instrument cluster.

- Brake immediately to defuse the situation. or
- Take evasive action provided it is safe to do so.

PRE-SAFE® Brake can also brake the vehicle automatically under the following conditions:

- the driver and front-passenger have their seat belts fastened and
  - the vehicle speed is between approximately 4 mph (7 km/h) and 124 mph (200 km/h)
- i** If there is an increased risk of collision, preventive passenger protection measures (PRE-SAFE®) are activated.

If the risk of collision with the vehicle in front remains and you do not brake, take evasive action or accelerate significantly, the vehicle may perform automatic emergency braking, up to the point of full brake application. Automatic emergency braking is not performed until immediately prior to an imminent accident.

You can prevent the intervention of the PRE-SAFE® Brake at any time by:

- depressing the accelerator pedal further.
- activating kickdown.
- releasing the brake pedal.

The braking action of PRE-SAFE® Brake is ended automatically if:

- you maneuver to avoid the obstacle.
- there is no longer any danger of a collision.
- there is no longer an obstacle detected in front of your vehicle.

## STEER CONTROL

### General information

STEER CONTROL helps you by transmitting a noticeable steering force to the steering wheel in the direction required for vehicle stabilization.

This steering assistance is provided in particular if:

- both right wheels or both left wheels are on a wet or slippery road surface when you brake.
- the vehicle starts to skid.

### Important safety notes

- i** Observe the "Important safety notes" section (▷ page 74).

No steering support is provided by STEER CONTROL, if:

- ESP® is malfunctioning.
- the lighting is faulty.

Power steering will, however, continue to function.

## Protection against theft

### Immobilizer

- ▶ **To activate with the SmartKey:** remove the SmartKey from the ignition lock.
- ▶ **To activate with KEYLESS-GO:** switch the ignition off and open the driver's door.
- ▶ **To deactivate:** switch on the ignition.

The immobilizer prevents your vehicle from being started without the correct SmartKey. When leaving the vehicle, always take the SmartKey with you and lock the vehicle. Anyone can start the engine if a valid SmartKey has been left inside the vehicle.

**i** The immobilizer is always deactivated when you start the engine.

In the event that the engine cannot be started (yet the vehicle's battery is charged), the system is not operational. Contact an authorized Mercedes-Benz Center or call 1-800-FOR-MERCEdes (in the USA) or 1-800-387-0100 (in Canada).



### ATA (anti-theft alarm system)



P54.32-B944-31

- ▶ **To arm:** lock the vehicle with the SmartKey or KEYLESS-GO. Indicator lamp ① flashes. The alarm system is armed after approximately 15 seconds.
- ▶ **To deactivate using the SmartKey:** unlock the vehicle with the SmartKey.
  - or
  - ▶ Insert the SmartKey into the ignition lock.
- ▶ **To deactivate using KEYLESS-GO:** unlock the vehicle with KEYLESS-GO.
  - or
  - ▶ Press the Start/Stop button on the dashboard. The SmartKey must be inside the vehicle.

A visual and audible alarm is triggered if the alarm system is armed and you open:

- a door
- the vehicle with the mechanical key
- the tailgate
- the hood
- ▶ **To turn the alarm off with the SmartKey:** press the  or  button on the SmartKey. The alarm is switched off.
  - or
  - ▶ Insert the SmartKey into the ignition lock. The alarm is switched off.
- ▶ **To stop the alarm using KEYLESS-GO:** grasp the outside door handle. The SmartKey must be outside the vehicle. The alarm is switched off.
  - or
  - ▶ Press the Start/Stop button on the dashboard. The SmartKey must be inside the vehicle. The alarm is switched off.

The alarm is not switched off, even if you close the open door that triggered it, for example.

**i** If the alarm continues for more than 30 seconds, the mbrace emergency call system automatically notifies the Customer Assistance Center. This is done either by text message or data connection. The emergency call system sends the message or data provided that:

- you have subscribed to the mbrace service.
- the mbrace service has been activated properly.
- the necessary mobile phone network is available.



Useful information .....	88
SmartKey .....	88
Doors .....	95
Cargo compartment .....	96
Side windows .....	100
Sliding sunroof .....	102



### Useful information

- i** This Operator's Manual describes all models and all standard and optional equipment of your vehicle available at the time of publication of the Operator's Manual. Country-specific differences are possible. Please note that your vehicle may not be equipped with all features described. This also applies to safety-related systems and functions.
- i** Read the information on qualified specialist workshops (► page 35).

### SmartKey

#### Important safety notes

##### **⚠ WARNING**

If children are left unsupervised in the vehicle, they could:

- open the doors, thus endangering other people or road users.
  - get out and disrupt traffic.
  - operate the vehicle's equipment.
- Additionally, children could set the vehicle in motion if, for example, they:
- release the parking brake.
  - shifting the automatic transmission out of park position **P**
  - Start the engine.

There is a risk of an accident and injury.

When leaving the vehicle, always take the SmartKey with you and lock the vehicle. Never leave children or animals unattended in the vehicle. Always keep the SmartKey out of reach of children.

##### **⚠ WARNING**

If persons, particularly children are subjected to prolonged exposure to extreme heat or cold, there is a risk of injury, possibly even fatal. Never leave children unattended in the vehicle.

##### **⚠ WARNING**

If you attach heavy or large objects to the SmartKey, the SmartKey could be unintentionally turned in the ignition lock. This could cause the engine to be switched off. There is a risk of an accident.

Do not attach any heavy or large objects to the SmartKey. Remove any bulky key rings before inserting the SmartKey into the ignition lock.

- !** Keep the SmartKey away from strong magnetic fields. Otherwise, the remote control function could be affected. Strong magnetic fields can occur in the vicinity of powerful electrical installations.

Do not store the SmartKey:

- with electronic devices, e.g. a mobile phone or another SmartKey.
- with metallic objects, e.g. coins or metal foil.
- inside metallic objects, e.g. a metal case. This can affect the functionality of the SmartKey.

Do not keep the KEYLESS-GO key in the temperature-controlled cup holder. Otherwise, the KEYLESS-GO key will not be recognized.

#### SmartKey functions

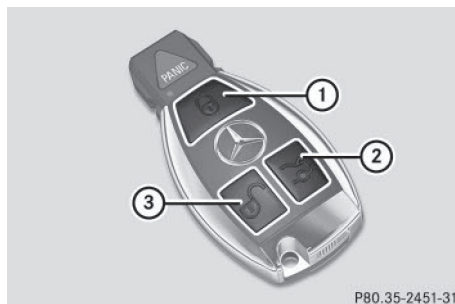

- ① Locks the vehicle
- ② Opens/closes the tailgate
- ③ Unlocks the vehicle

► **To unlock centrally:** press the ③ button.

If you do not open the vehicle within approximately 40 seconds of unlocking:

- the vehicle is locked again.
- protection against theft is reactivated.

► **To lock centrally:** press button ①.

The SmartKey centrally locks and unlocks the following components:

- the doors
- the tailgate
- the fuel filler flap

The turn signals flash once when unlocking and three times when locking.

You can also set an audible signal to confirm that the vehicle has been locked. The audible signal can be activated and deactivated using the on-board computer (► page 199).

You will receive visual and acoustic locking confirmation if all components were able to be locked.

When it is dark, the surround lighting also comes on if it is activated in the on-board computer (► page 199).

## KEYLESS-GO

### General notes

Bear in mind that the engine can be started by any of the vehicle occupants if there is a KEYLESS-GO key in the vehicle.

### Locking/unlocking centrally

You can start, lock or unlock the vehicle using KEYLESS-GO. To do this, you only need carry the SmartKey with you. You can combine the functions of KEYLESS-GO with those of a conventional SmartKey. Unlock the vehicle by using KEYLESS-GO, for instance, and lock it using the  button on the SmartKey.

When locking or unlocking with KEYLESS-GO, the distance between the SmartKey and the corresponding door handle must not be greater than 3 ft (1 m).

KEYLESS-GO checks whether a valid SmartKey is in the vehicle by periodically establishing a radio connection between the vehicle and the SmartKey. This happens:

- when the external door handles are touched
- when starting the engine
- while the vehicle is in motion

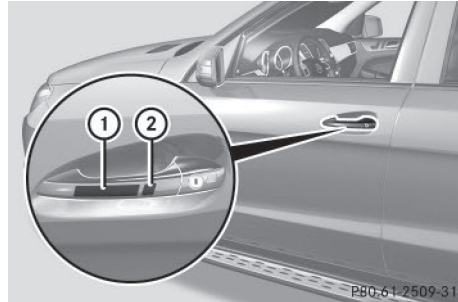

► **To unlock the vehicle:** touch the inner surface of the door handle.

► **To lock the vehicle:** touch sensor surface ①.

► **Convenience closing feature:** touch recessed sensor surface ② for an extended period.

If you pull on the handle of the tailgate, only the cargo compartment of the vehicle is unlocked.

### Deactivating and activating

If you do not intend to use a key for an extended period of time, you can deactivate the KEYLESS-GO function of the SmartKey. The SmartKey will then use very little power, thereby conserving battery power. For the purposes of activation/deactivation, the vehicle must not be nearby.

- ▶ **To deactivate:** press the  button on the SmartKey twice in rapid succession. The battery check lamp (▷ page 91) of the SmartKey flashes twice briefly and lights up once, then KEYLESS-GO is deactivated.
- ▶ **To activate:** press any button on the SmartKey or insert the SmartKey into the ignition lock. KEYLESS-GO and all of its associated features are available again.

#### KEYLESS-GO start function

Bear in mind that the engine can be started by any of the vehicle occupants if there is a SmartKey in the vehicle.

#### Changing the settings of the locking system

You can find information about this in the Digital Operator's Manual.

#### Mechanical key

##### General notes

If the vehicle can no longer be locked or unlocked with the SmartKey, use the mechanical key.

If you use the mechanical key to unlock and open the driver's door, the anti-theft alarm system will be triggered (▷ page 84).

There are several ways to turn off the alarm:

- ▶ **To turn the alarm off with the SmartKey:** press the  or  button on the SmartKey.

or

- ▶ Insert the SmartKey into the ignition lock.

or

- ▶ **To deactivate the alarm with KEYLESS-GO:** press the Start/Stop button in the ignition lock. The SmartKey must be in the vehicle.

or

- ▶ Lock or unlock the vehicle using KEYLESS-GO. The SmartKey must be outside the vehicle.

If you unlock the vehicle using the mechanical key, the fuel filler flap will not be unlocked automatically.

- ▶ **To unlock the fuel filler flap:** insert the SmartKey into the ignition lock.

#### Removing the mechanical key



- ▶ Push release catch ① in the direction of the arrow and at the same time remove mechanical key ② from the SmartKey.

For further information about:

- unlocking the driver's door (▷ page 95)
- unlocking the cargo compartment (▷ page 100)
- locking the vehicle (▷ page 96)

#### Inserting the mechanical key

- ▶ Push mechanical key ② completely into the SmartKey until it engages and release catch ① is back in its basic position.

#### SmartKey battery

#### Important safety notes

##### WARNING

Batteries contain toxic and corrosive substances. If batteries are swallowed, it can result in

severe health problems. There is a risk of fatal injury.





Keep batteries out of the reach of children. If a battery is swallowed, seek medical attention immediately.

Mercedes-Benz recommends that you have the batteries replaced at a qualified specialist workshop.

The SmartKey batteries contain perchlorate material, which may require special handling and regard for the environment. National guidelines must be observed during disposal. In California, see [www.dtsc.ca.gov/HazardousWaste/Perchlorate/index.cfm](http://www.dtsc.ca.gov/HazardousWaste/Perchlorate/index.cfm).

### Checking the battery



- ▶ Press the  or  button. The battery is working properly if battery check lamp ① lights up briefly. The battery is discharged if battery check lamp ① does not light up briefly.
- ▶ Change the battery (▷ page 91).
- ❗ If the SmartKey battery is checked within the signal reception range of the vehicle, pressing the  or  button:
  - locks or
  - unlocks the vehicle
- ❗ You can get a battery at any qualified specialist workshop.

### Replacing the battery

You require a CR 2025 3 V cell battery.

- ▶ Take the mechanical key out of the SmartKey (▷ page 90).

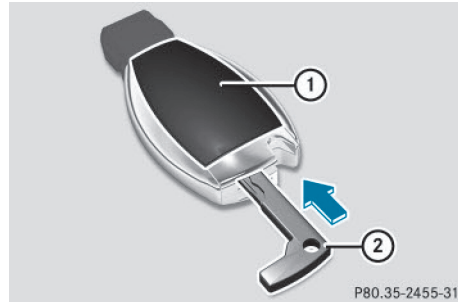

- ▶ Press mechanical key ② into the opening in the SmartKey in the direction of the arrow until battery compartment cover ① opens. Do not hold battery compartment cover ① closed while doing so.
- ▶ Remove battery compartment cover ①.

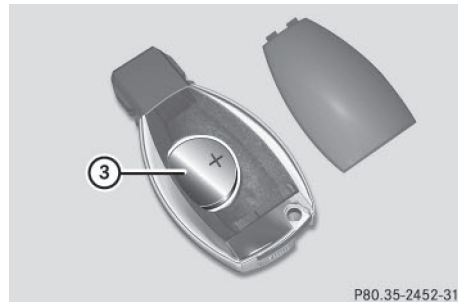

- ▶ Repeatedly tap the SmartKey against your palm until battery ③ falls out.
- ▶ Insert the new battery with the positive terminal facing upwards. Use a lint-free cloth to do so.
- ▶ Make sure that the surface of the battery is free of lint, grease and other contaminants.
- ▶ Insert the front tabs of battery compartment cover ① into the housing first and then press to close it.

- ▶ Insert mechanical key ② into the Smart-Key.
- ▶ Check the function of all SmartKey buttons on the vehicle.

### Problems with the SmartKey

You can find information about this in the Digital Operator's Manual.

Problem	Possible causes/consequences and ► Solutions
You cannot lock or unlock the vehicle using the SmartKey.	<p>The SmartKey battery is discharged or nearly discharged.</p> <p>If this does not work:</p> <ul style="list-style-type: none"> <li>► Check the SmartKey battery and replace it if necessary (&gt; page 91).</li> <li>► Unlock (&gt; page 95) or lock (&gt; page 96) the vehicle using the mechanical key.</li> </ul>
	<p>The SmartKey is faulty.</p> <ul style="list-style-type: none"> <li>► Unlock (&gt; page 95) or lock (&gt; page 96) the vehicle using the mechanical key.</li> <li>► Have the SmartKey checked at a qualified specialist workshop.</li> </ul>
You can no longer lock or unlock the vehicle using KEYLESS-GO.	<p>KEYLESS-GO was deactivated.</p> <ul style="list-style-type: none"> <li>► Reactivate KEYLESS-GO (&gt; page 89).</li> </ul>
	<p>The SmartKey battery is discharged or nearly discharged.</p> <ul style="list-style-type: none"> <li>► Check the SmartKey battery (&gt; page 91) and replace it if necessary (&gt; page 91).</li> </ul> <p>If this does not work:</p> <ul style="list-style-type: none"> <li>► Unlock (&gt; page 95) or lock (&gt; page 96) the vehicle using the mechanical key.</li> </ul>
	<p>There is interference from a powerful source of radio waves.</p> <ul style="list-style-type: none"> <li>► Unlock (&gt; page 95) or lock (&gt; page 96) the vehicle using the mechanical key.</li> </ul>
	<p>KEYLESS-GO is malfunctioning.</p> <ul style="list-style-type: none"> <li>► Lock/unlock the vehicle using the remote control function of the SmartKey.</li> <li>► Have the vehicle and SmartKey checked at a qualified specialist workshop.</li> </ul> <p>If the vehicle can also not be locked/unlocked using the remote control function:</p> <ul style="list-style-type: none"> <li>► Unlock (&gt; page 95) or lock (&gt; page 96) the vehicle using the mechanical key.</li> <li>► Have the vehicle and SmartKey checked at a qualified specialist workshop.</li> </ul>

Problem	Possible causes/consequences and ► Solutions
You have lost a SmartKey.	<ul style="list-style-type: none"> <li>► Have the SmartKey deactivated at a qualified specialist workshop.</li> <li>► Report the loss immediately to the vehicle insurers.</li> <li>► If necessary, have the locks changed as well.</li> </ul>
You have lost the mechanical key.	<ul style="list-style-type: none"> <li>► Report the loss immediately to the vehicle insurers.</li> <li>► If necessary, have the locks changed as well.</li> </ul>
The engine cannot be started using the SmartKey.	<p>The on-board voltage is too low.</p> <ul style="list-style-type: none"> <li>► Switch off non-essential consumers, e.g. seat heating or interior lighting, and try to start the engine again.</li> </ul> <p>If this does not work:</p> <ul style="list-style-type: none"> <li>► Check the starter battery and charge it if necessary (▷ page 282).</li> </ul> <p>or</p> <ul style="list-style-type: none"> <li>► Jump-start the vehicle (▷ page 283).</li> </ul> <p>or</p> <ul style="list-style-type: none"> <li>► Consult a qualified specialist workshop.</li> </ul>
	<p>The vehicle is locked.</p> <ul style="list-style-type: none"> <li>► Unlock the vehicle and try to start the vehicle again.</li> </ul> <p>The SmartKey battery is discharged or nearly discharged.</p> <ul style="list-style-type: none"> <li>► Check the SmartKey battery (▷ page 91) and replace it if necessary (▷ page 91).</li> </ul> <p>If this does not work:</p> <ul style="list-style-type: none"> <li>► Start your vehicle with the SmartKey in the ignition lock.</li> </ul> <p>There is interference from a powerful source of radio waves.</p> <ul style="list-style-type: none"> <li>► Start your vehicle with the SmartKey in the ignition lock.</li> </ul>



## Doors

### Important safety notes

#### **WARNING**

If children are left unsupervised in the vehicle, they could:

- open the doors, thus endangering other people or road users.
- get out and disrupt traffic.
- operate the vehicle's equipment.

Additionally, children could set the vehicle in motion if, for example, they:

- release the parking brake.
- shifting the automatic transmission out of park position **P**
- Start the engine.

There is a risk of an accident and injury.

When leaving the vehicle, always take the SmartKey with you and lock the vehicle. Never leave children or animals unattended in the vehicle. Always keep the SmartKey out of reach of children.

#### **WARNING**

If persons, particularly children are subjected to prolonged exposure to extreme heat or cold, there is a risk of injury, possibly even fatal. Never leave children unattended in the vehicle.

#### **WARNING**

If objects, luggage or loads are not secured or not secured sufficiently, they could slip, tip over or be flung around and thereby hit vehicle occupants. There is a risk of injury, particularly in the event of sudden braking or a sudden change in direction.

Always store objects so that they cannot be flung around. Secure objects, luggage or loads against slipping or tipping before the journey.

You should preferably place luggage or loads in the cargo compartment. Observe the loading guidelines (▷ page 248).

### Information in the Digital Operator's Manual

In the Digital Operator's Manual you will find information on the following topics:

- Unlocking and opening doors from the inside
- Centrally locking and unlocking the vehicle from the inside
- Automatic locking feature
- Power closing feature

### Unlocking the driver's door (mechanical key)

If the vehicle can no longer be locked or unlocked with the SmartKey or KEYLESS-GO, use the mechanical key.

If you use the mechanical key to unlock and open the driver's door, the anti-theft alarm system will be triggered (▷ page 84).

- ▶ Take the mechanical key out of the SmartKey (▷ page 90).
- ▶ Insert the mechanical key into the lock of the driver's door as far as it will go.

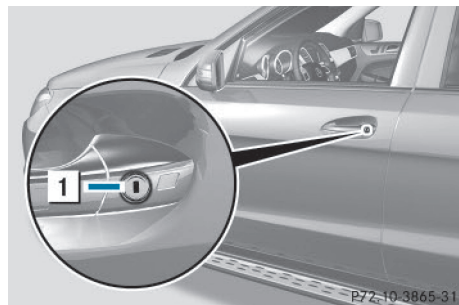

- ▶ Turn the mechanical key counter-clockwise to position **1**. The door is unlocked.
- ▶ Turn the mechanical key back and remove it.
- ▶ Insert the mechanical key into the SmartKey.

**Locking the vehicle (mechanical key)**

If the vehicle can no longer be locked with the SmartKey, use the mechanical key.

- ▶ Open the driver's door.
- ▶ Close the front-passenger door, the rear doors and the tailgate.
- ▶ Press the locking button (▷ page 95).
- ▶ Check whether the locking knobs on the front-passenger door and the rear doors are still visible. Press down the locking knobs by hand, if necessary.
- ▶ Close the driver's door.
- ▶ Take the mechanical key out of the SmartKey (▷ page 90).
- ▶ Insert the mechanical key into the lock of the driver's door as far as it will go.

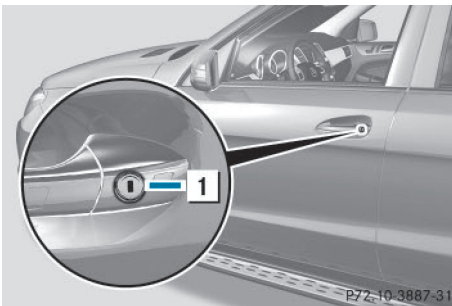

- ▶ Turn the mechanical key clockwise as far as it will go to position **1**.
  - ▶ Turn the mechanical key back and remove it.
  - ▶ Make sure that the doors and the tailgate are locked.
  - ▶ Insert the mechanical key into the SmartKey.
- i** If you lock the vehicle as described above, the fuel filler flap is not locked. The anti-theft alarm system is not armed.

**Cargo compartment****Important safety notes****⚠ WARNING**

If persons, particularly children are subjected to prolonged exposure to extreme heat or cold, there is a risk of injury, possibly even fatal. Never leave children unattended in the vehicle.

**⚠ WARNING**

Combustion engines emit poisonous exhaust gases such as carbon monoxide. If the tailgate is open when the engine is running, particularly if the vehicle is moving, exhaust fumes could enter the passenger compartment. There is a risk of poisoning. Turn off the engine before opening the tailgate. Never drive with the tailgate open.

**⚠ WARNING**

If objects, luggage or loads are not secured or not secured sufficiently, they could slip, tip over or be flung around and thereby hit vehicle occupants. There is a risk of injury, particularly in the event of sudden braking or a sudden change in direction.

Always store objects so that they cannot be flung around. Secure objects, luggage or loads against slipping or tipping before the journey.

- !** The tailgate swings upwards and to the rear when opened. Therefore, make sure that there is sufficient clearance above and behind the tailgate.

- i** Tailgate opening dimensions (▷ page 340).

You should preferably place luggage or loads in the cargo compartment. Observe the loading guidelines (▷ page 248).

Do not leave the SmartKey in the cargo compartment. You could otherwise lock yourself out.

You can:

- close the tailgate manually from outside
- open and close the tailgate automatically from outside
- open and close the tailgate automatically from inside
- limit the opening angle of the tailgate
- unlock the tailgate from inside with the emergency release

### Tailgate reversing feature

On vehicles with tailgate remote closing feature, the tailgate is equipped with automatic obstacle recognition with a reversing feature. If a solid object blocks or restricts the tailgate when automatically opening or closing, this procedure is stopped. If the tailgate is stopped during the closing procedure, it will open again automatically. The automatic obstacle recognition with reversing feature is only an aid. It is not a substitute for your attentiveness when opening and closing the tailgate.

#### WARNING

The reversing feature does not react:

- to soft, light and thin objects, e.g. small fingers
- over the last 1/3 in (8 mm) of the closing movement

This means that the reversing feature cannot prevent someone being trapped in these situations. There is a risk of injury.

Make sure that no body parts are in close proximity during the closing procedure.

If somebody becomes trapped:

- press the  button on the SmartKey, or
- pull or press the remote operating switch on the driver's door or
- press the closing or locking button on the tailgate or
- pull the handle on the tailgate

### Opening and closing manually from outside

#### Opening

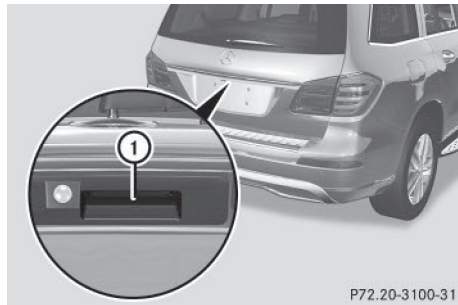

- ▶ Press the  button on the SmartKey.
- ▶ Pull handle ① and release it. The tailgate opens automatically.

#### Closing

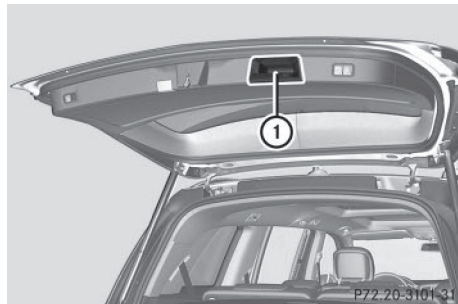

- ▶ Pull the tailgate down using recess ①.
- ▶ Allow the tailgate to drop into the lock.
- ▶ Lock the vehicle if necessary with the  button on the SmartKey or with KEYLESS-GO.

- i** If a KEYLESS-GO key is detected in the cargo compartment, the tailgate will not lock.

### Opening/closing automatically from outside

#### Important safety notes

#### WARNING

Parts of the body could become trapped during automatic closing of the tailgate. Moreover, people, e.g. children, may be standing in the closing area or may enter the closing area during the closing process. There is a risk of injury.

Make sure that nobody is in the vicinity of the closing area during the closing process.

Use one of the following options to stop the closing process:

- press the  button on the SmartKey.
- pull or press the remote operating switch on the driver's door.
- press the closing or locking button on the tailgate.
- pull the handle on the tailgate

#### WARNING

Combustion engines emit poisonous exhaust gases such as carbon monoxide. If the tailgate is open when the engine is running, particularly if the vehicle is moving, exhaust fumes could enter the passenger compartment. There is a risk of poisoning.

Turn off the engine before opening the tailgate. Never drive with the tailgate open.

**!** The tailgate swings upwards and to the rear when opened. Therefore, make sure that there is sufficient clearance above and behind the tailgate.

- i** Tailgate opening dimensions (▷ page 340).
- i** Notes on the automatic reversing feature for the tailgate (▷ page 97).

### Opening the tailgate automatically

You can open the tailgate automatically with the SmartKey or the handle in the tailgate.

- ▶ Press and hold the  button on the SmartKey until the tailgate opens.

or

- ▶ If the tailgate is unlocked, pull the handle and let it go again immediately.

### Closing the tailgate automatically

#### WARNING

Parts of the body could become trapped during automatic closing of the tailgate. Moreover, people, e.g. children, may be standing in the closing area or may enter the closing area during the closing process. There is a risk of injury.

Make sure that nobody is in the vicinity of the closing area during the closing process.

Use one of the following options to stop the closing process:

- press the  button on the SmartKey.
- pull or press the remote operating switch on the driver's door.
- press the closing or locking button on the tailgate.
- pull the handle on the tailgate

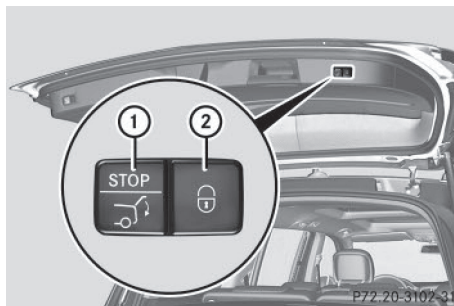

Closing and locking button (example: vehicle with KEYLESS-GO)

► **To close:** press closing button ① on the tailgate.

or

► Press and hold the  button on the SmartKey until the tailgate closes. You can release the button as soon as the tailgate starts to close.

Vehicles with KEYLESS-GO: you can simultaneously close and lock the tailgate.

► Press locking button ② on the tailgate. If a KEYLESS-GO key is detected outside the vehicle, the tailgate closes and locks. All the doors must be shut and the SmartKey located in the vicinity of the tailgate.

**i** The tailgate cannot be opened and closed with the SmartKey if there is a SmartKey in the ignition.

If the tailgate touches an object while closing, the closing procedure is interrupted and the tailgate reopens.

**i** If a KEYLESS-GO key is detected in the cargo compartment, the tailgate will not lock.

### Opening/closing automatically from inside

#### Important safety notes

##### WARNING

Parts of the body could become trapped during automatic closing of the tailgate. Moreover, people, e.g. children, may be standing in the closing area or may enter the closing area during the closing process. There is a risk of injury.

Make sure that nobody is in the vicinity of the closing area during the closing process.

Use one of the following options to stop the closing process:

- press the  button on the SmartKey.
- pull or press the remote operating switch on the driver's door.

- press the closing or locking button on the tailgate.
- pull the handle on the tailgate

##### WARNING

Combustion engines emit poisonous exhaust gases such as carbon monoxide. If the tailgate is open when the engine is running, particularly if the vehicle is moving, exhaust fumes could enter the passenger compartment. There is a risk of poisoning.

Turn off the engine before opening the tailgate. Never drive with the tailgate open.

**!** The tailgate swings upwards and to the rear when opened. Therefore, make sure that there is sufficient clearance above and behind the tailgate.

**i** Tailgate opening dimensions (▷ page 340).

**i** Notes on the automatic reversing feature for the tailgate (▷ page 97).

#### Opening and closing



You can open and close the tailgate from the driver's seat when the vehicle is stationary and unlocked.

- **To open:** pull remote operating switch ① for the tailgate until the tailgate opens.
- **To close:** turn the SmartKey to position 1 or 2 in the ignition lock.
- Press remote operating switch for tailgate ① until the tailgate is completely closed.

### Limiting the opening angle of the tailgate

#### Important safety notes

- ❗ Make sure there is sufficient clearance to open the tailgate fully when setting the opening angle. The tailgate could otherwise be damaged. Ideally, set the opening angle outside.

#### Activating

You can limit the opening angle of the tailgate. This is possible in the top half of its opening range, up to approximately 4 in (10 cm) before the stop.

This could be useful, for example, if there is insufficient space above the tailgate.

- ▶ **To open the tailgate:** pull the handle on the tailgate.
- ▶ **To stop the opening procedure at the desired position:** press the closing button (▷ page 98) in the tailgate or pull the handle on the outside of the tailgate again.
- ▶ **To store the position:** press and hold the closing button in the tailgate until you hear a short tone.  
The opening angle limiter is activated. The tailgate will now stop in the stored position when opening.

#### Deactivating

- ▶ Press and hold the closing button (▷ page 98) in the tailgate until you hear two short tones.

### Tailgate emergency release

#### Important safety notes

- ❗ The tailgate swings upwards and to the rear when opened. Therefore, make sure that there is sufficient clearance above and behind the tailgate.

- ❗ Tailgate opening dimensions (▷ page 340).

If the tailgate can no longer be unlocked:

- using the SmartKey, or
- using the remote operating switch in the door control panel:

Use the emergency release.

#### Opening

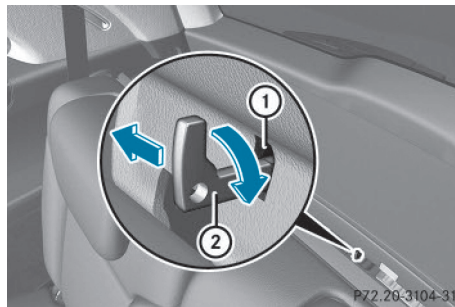

- ▶ Take the mechanical key out of the SmartKey (▷ page 90).
- ▶ Insert mechanical key ② into the opening in paneling ①.
- ▶ Turn mechanical key ② 90° clockwise.
- ▶ Push mechanical key ② in the direction of the arrow and open the tailgate.
- ▶ Insert the mechanical key into the SmartKey.

### Side windows

#### Important safety notes

#### ⚠ WARNING

While opening the side windows, body parts could become trapped between the side window and the door frame as the side window moves. There is a risk of injury.

Make sure that nobody touches the side window during the opening procedure. If somebody becomes trapped, release the switch or pull the switch to close the side window again.

**⚠ WARNING**

While closing the side windows, body parts in the closing area could become trapped. There is a risk of injury.

When closing make sure that no parts of the body are in the closing area. If somebody becomes trapped, release the switch or press the switch to open the side window again.

**⚠ WARNING**

If children operate the side windows they could become trapped, particularly if they are left unsupervised. There is a risk of injury.

Activate the override feature for the rear side windows. When leaving the vehicle, always take the SmartKey with you and lock the vehicle. Never leave children unsupervised in the vehicle.

**Side window reversing feature**

The side windows are equipped with an automatic reversing feature. If a solid object blocks or restricts a side window during the closing process, the side window opens again automatically. However, the automatic reversing feature is only an aid and does not relieve you of the responsibility of paying attention when closing a side window.

**⚠ WARNING**

The reversing feature does not react:

- to soft, light and thin objects, e.g. small fingers
- over the last 1/6 in(4 mm) of the closing movement
- during resetting
- when closing the side window again manually immediately after automatic reversing

This means that the reversing feature cannot prevent someone being trapped in these situations. There is a risk of injury.

Make sure that no body parts are in close proximity during the closing procedure. If

someone becomes trapped, press the switch to open the side window again.

**Information in the Digital Operator's Manual**

In the Digital Operator's Manual you will find information on the following topics:

- Opening and closing the side windows
- Opening and closing the hinged side windows
- Convenience opening
- Convenience closing
- Resetting the side windows



### Problems with the side windows

#### WARNING

If you close a side window again immediately after it has been blocked or reset, the side window closes with increased or maximum force. The reversing feature is then not active. Parts of the body could be trapped in the closing area in the process. This poses an increased risk of injury or even fatal injury.

Make sure that no parts of the body are in the closing area. To stop the closing process, release the switch or push the switch again to reopen the side window.

Problem	Possible causes/consequences and ► Solutions
A side window cannot be closed because it is blocked by objects, e.g. leaves in the window guide.	<ul style="list-style-type: none"> <li>► Remove the objects.</li> <li>► Close the side window.</li> </ul>
A side window cannot be closed and you cannot see the cause.	<p>If a side window is obstructed during closing and reopens again slightly:</p> <ul style="list-style-type: none"> <li>► Immediately after the window blocks, pull the corresponding switch again until the side window has closed. The side window is closed with increased force.</li> </ul> <p>If a side window is obstructed again during closing and reopens again slightly:</p> <ul style="list-style-type: none"> <li>► Immediately after the window blocks, pull the corresponding switch again until the side window has closed. The side window is closed without the anti-entrapment feature.</li> </ul>

### Sliding sunroof

#### Important safety notes

Your vehicle may be equipped with a sliding sunroof or a panorama roof with power tilt/sliding panel. In this section, the term "sliding sunroof" refers to both types of sliding sunroof.

#### WARNING

While opening and closing the sliding sunroof, body parts in close proximity could become trapped. There is a risk of injury.

Make sure that no body parts are in close proximity during the opening and closing procedures.

If somebody becomes trapped:

- release the switch immediately, or
- during automatic operation, push the switch briefly in any direction

The opening or closing procedure will be stopped.

#### WARNING

If children operate the sliding sunroof they could become trapped, particularly if they are left unsupervised. There is a risk of injury.

When leaving the vehicle, always take the SmartKey with you and lock the vehicle. Never leave children unsupervised in the vehicle.

**!** Only open the sliding sunroof if it is free of snow and ice. Otherwise, malfunctions may occur.

Do not allow anything to protrude from the sliding sunroof. Otherwise, the seals could be damaged.

**!** The weather can change abruptly. It could start to rain or snow. Make sure that the sliding sunroof is closed when you leave the vehicle. The vehicle electronics can be damaged if water enters the vehicle interior.

**i** Resonance noises can occur in addition to the usual airflow noises when the sliding sunroof is open. They are caused by minor pressure fluctuations in the vehicle interior. Change the position of the sliding sunroof or open a side window. The noise will be reduced or eliminated.

### Sliding sunroof reversing feature

The sliding sunroof is equipped with an automatic reversing feature. If a solid object blocks or restricts the sliding sunroof during the closing process, the sliding sunroof opens again automatically. However, the automatic reversing feature is only an aid and does not relieve you of the responsibility of paying attention when closing the sliding sunroof.

#### **⚠ WARNING**

The reversing feature does not react:

- to soft, light and thin objects, e.g. small fingers
- over the last 1/6 in (4 mm) of the closing movement
- during resetting
- when closing the sliding sunroof again manually immediately after automatic reversing

This means that the reversing feature cannot prevent someone being trapped in these situations. There is a risk of injury.

Make sure that no body parts are in close proximity during the closing procedure.

If somebody becomes trapped:

- release the switch immediately, or
- press the switch in any direction during the automatic closing process

The closing process is stopped.

### Operating the sliding sunroof

#### Opening and closing

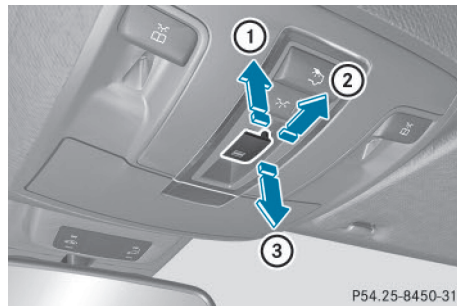

Overhead control panel

- ① To raise
- ② To open
- ③ To close/lower

► Turn the SmartKey to position **1** or **2** in the ignition lock.

► Press or pull the  switch in the corresponding direction.

**i** If you press the  switch beyond the point of resistance, an automatic opening/closing process is started in the corresponding direction. You can stop automatic operation by pressing/pulling the switch again.

When opening and raising the roof, automatic operation is only available if the sliding sunroof is in the closed position.

The sun protection cover automatically opens along with the sliding sunroof. You can open or close the sun protection cover manually when the sliding sunroof is raised or closed.

**i** You can continue to operate the sliding sunroof after switching off the engine or removing the SmartKey from the ignition

lock. This function is available for up to five minutes or until the driver's or front-passenger door is opened.

### Resetting

**!** If the sliding sunroof still cannot be opened or closed fully after resetting, contact a qualified specialist workshop.

Reset the sliding sunroof if it does not move smoothly.

- ▶ Turn the SmartKey to position **1** or **2** in the ignition lock.
- ▶ Raise the sliding sunroof fully at the rear (▷ page 103).
- ▶ Keep the  switch pressed for another second.
- ▶ Make sure that the sliding sunroof can be fully opened and closed again (▷ page 103).
- ▶ If this is not the case, repeat the steps above again.

### Operating the panorama roof with power tilt/sliding panel

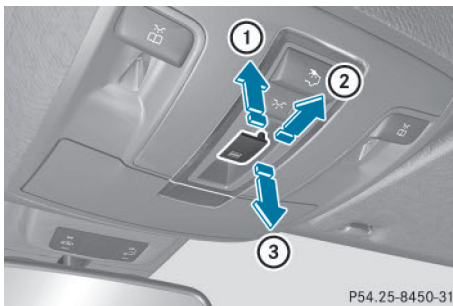

Overhead control panel

- ① To raise
- ② To open
- ③ To close/lower

The panorama roof with power tilt/sliding panel can only be operated when the roller sunblind is open (▷ page 105).

▶ **To open and close:** turn the SmartKey to position **1** or **2** in the ignition lock.

▶ Press or pull the  switch in the corresponding direction.

**i** If you press the  switch beyond the point of resistance, an automatic opening/closing process is started in the corresponding direction. You can stop automatic operation by pressing/pulling the switch again.

Automatic operation for raising is available only when the sliding sunroof is closed.

### Operating the roller sunblinds for the panorama roof with power tilt/sliding panel

#### Important safety notes

##### WARNING

Parts of the body could become trapped between the roller sunblind and frame or sliding sunroof during automatic opening or closing. There is a risk of injury.

When opening or closing, make sure that no body parts are in the sweep of the roller sunblind.

If somebody becomes trapped:

- release the switch immediately, or
- during automatic operation, push the switch briefly in any direction

The opening or closing procedure will be stopped.

The roller sunblinds shield the vehicle interior from sunlight. The roller sunblinds can only be opened and closed together when the panorama roof with power tilt/sliding panel is closed.

#### Roller sunblind reversing feature

The roller sunblinds are equipped with an automatic reversing feature. If a solid object blocks or restricts a roller sunblind during the closing process, the roller sunblind opens

again automatically. However, the automatic reversing feature is only an aid and does not relieve you of the responsibility of paying attention when closing the roller sunblinds.

#### **WARNING**

The reversing feature does not react in particular to soft, light and thin objects, e.g. small fingers. This means that the reversing feature cannot prevent someone being trapped in these situations. There is a risk of injury.

When closing the roller sunblind, make sure that no body parts are in the sweep area.

If somebody becomes trapped:

- release the switch immediately, or
- press the switch in any direction during the automatic closing process

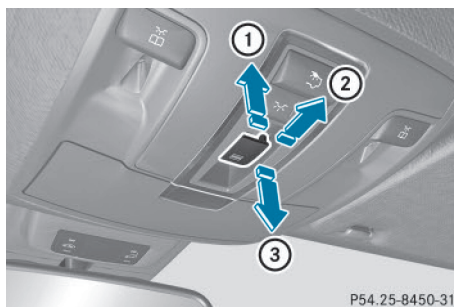

The closing process is stopped.

### Opening and closing the roller sunblinds



Overhead control panel

- ① To open
- ② To open
- ③ To close





- ▶ Turn the SmartKey to position **1** or **2** in the ignition lock.
- ▶ Press or pull the  switch in the corresponding direction.
- i** If you press the  switch beyond the point of resistance, an automatic opening/closing process is started in the corresponding direction. You can stop automatic

operation by pressing/pulling the switch again.

### Resetting the panorama roof with power tilt/sliding panel and the roller sunblinds

- !** If the panorama roof with power tilt/sliding panel and the roller sunblinds cannot be fully opened or closed after resetting, contact a qualified specialist workshop.

Reset the panorama roof with power tilt/sliding panel and the roller sunblinds if the panorama roof with power tilt/sliding panel or the roller sunblinds do not move smoothly.

- ▶ Turn the SmartKey to position **1** or **2** in the ignition lock.
- ▶ Pull the  switch repeatedly to the point of resistance in the direction of arrow ③ until the panorama roof with power tilt/sliding panel is fully closed.
- ▶ Keep the  switch pulled for an additional second.
- ▶ Pull the  switch repeatedly to the point of resistance in the direction of arrow ③ until the roller sunblinds are fully closed.
- ▶ Keep the  switch pulled for an additional second.
- ▶ Make sure that the panorama roof with power tilt/sliding panel (▷ page 104) and the roller sunblinds (▷ page 105) can be fully opened again.
- ▶ If this is not the case, repeat the steps above again.

### Problems with the sliding sunroof

Your vehicle may be equipped with a sliding sunroof or a panorama roof with power tilt/sliding panel. In this section, the term "sliding sunroof" refers to both types of sliding sunroof.

#### WARNING

If you close the sliding sunroof again immediately after it has been blocked or reset, the sliding sunroof closes with increased or maximum force. The reversing feature is then not active. Parts of the body could be trapped in the closing area in the process. This poses an increased risk of injury or even fatal injury.



Make sure that no parts of the body are in the closing area.

If somebody becomes trapped:

- release the switch immediately, or
- press the switch in any direction during the automatic closing process

The closing process is stopped.

 If the sliding sunroof still cannot be opened or closed as a result of a malfunction, contact a qualified specialist workshop.

Problem	Possible causes/consequences and ► Solutions
The sliding sunroof cannot be closed and you cannot see the cause.	<p>If the sliding sunroof is obstructed during closing and reopens again slightly:</p> <p>► Immediately after the sliding sunroof blocks, pull the  switch in the overhead control panel down to the point of resistance and hold it until the sliding sunroof is closed. The sliding sunroof is closed with increased force.</p> <p>If the sliding sunroof is obstructed again during closing and then reopens slightly:</p> <p>► Immediately after the sliding sunroof blocks, pull the  switch in the overhead control panel down to the point of resistance and hold it until the sliding sunroof is closed. The sliding sunroof is closed without the anti-entrapment feature.</p>

 Notes on the automatic reversing feature of the sliding sunroof (► page 103).

Useful information .....	108
Correct driver's seat position .....	108
Seats .....	109
Steering wheel .....	111
Mirrors .....	112
Memory function .....	112

## Useful information

- i** This Operator's Manual describes all models and all standard and optional equipment of your vehicle available at the time of publication of the Operator's Manual. Country-specific differences are possible. Please note that your vehicle may not be equipped with all features described. This also applies to safety-related systems and functions.
- i** Read the information on qualified specialist workshops (▷ page 35).

## Correct driver's seat position

**⚠ WARNING**

You could lose control of your vehicle if you do the following while driving:

- adjust the driver's seat, head restraint, steering wheel or mirrors
- fasten the seat belt

There is a risk of an accident.

Adjust the driver's seat, head restraint, steering wheel and mirror and fasten your seat belt before starting the engine.



- ▶ Observe the safety guidelines on seat adjustment (▷ page 109).
- ▶ Check whether you have adjusted seat ③ properly (▷ page 110).

Electrical seat adjustment (▷ page 110)

When adjusting the seat, make sure that:

- you are as far away from the driver's air bag as possible
  - you are sitting in a normal upright position
  - you can fasten the seat belt properly
  - you have moved the backrest to an almost vertical position
  - you have set the seat cushion angle so that your thighs are gently supported
  - you can depress the pedals properly
- ▶ Check whether the head restraint is adjusted properly (▷ page 110).

When doing so, make sure that you have adjusted the head restraint so that the back of your head is supported at eye level by the center of the head restraint.

- ▶ Observe the safety notes on steering column adjustment (▷ page 111).
- ▶ Make sure that steering wheel ① is adjusted properly.

Adjusting the steering wheel manually (▷ page 111)

Adjusting the steering wheel electrically (▷ page 111)

When adjusting the steering wheel column, make sure that:

- you can hold the steering wheel with your arms slightly bent
  - you can move your legs freely
  - you can see all the displays in the instrument cluster clearly
- ▶ Observe the safety guidelines for seat belts (▷ page 52).
  - ▶ Check whether you have fastened seat belt ② properly (▷ page 54).



The seat belt should:

- fit snugly across your body
  - be routed across the middle of your shoulder
  - be routed in your pelvic area across the hip joints
- ▶ Before starting off, adjust the rear-view mirror and the exterior mirrors in such a way that you have a good view of road and traffic conditions (▷ page 112).
- ▶ **Vehicles with a memory function:** save the seat, steering wheel and exterior mirror settings with the memory function (▷ page 112).

## Seats

### Important safety notes

#### WARNING

Children could become trapped if they adjust the seats, particularly when unattended. There is a risk of injury.

When leaving the vehicle, always take the SmartKey with you and lock the vehicle. Never leave children unsupervised in the vehicle.

The seats can still be adjusted when there is no SmartKey in the ignition lock.

#### WARNING

When you adjust a seat, you or other vehicle occupants could become trapped, e.g. on the seat guide rail. There is a risk of injury.

Make sure when adjusting a seat that no one has any body parts in the sweep of the seat.

Observe the safety notes on "Air bags" (▷ page 56) and "Children in the Vehicle" (▷ page 67).

#### WARNING

You could lose control of your vehicle if you do the following while driving:

- adjust the driver's seat, head restraint, steering wheel or mirrors
- fasten the seat belt

There is a risk of an accident.

Adjust the driver's seat, head restraint, steering wheel and mirror and fasten your seat belt before starting the engine.

#### WARNING

If you adjust the seat height carelessly, you or other vehicle occupants could be trapped and thereby injured. Children in particular could accidentally press the electrical seat adjustment buttons and become trapped. There is a risk of injury.

While moving the seats, make sure that your hands or other body parts do not get under the lever assembly of the seat adjustment system.

#### WARNING

If the head restraints are not installed or not adjusted correctly, they cannot provide protection as intended. There is an increased risk of injury in the head and neck area, e.g. in the event of an accident or when braking.

Always drive with the head restraints installed. Before driving off, make sure for every vehicle occupant that the center of the head restraint supports the back of the head at about eye level.

#### WARNING

The seat belt does not offer the intended level of protection if you have not moved the backrest to an almost vertical position. When braking or in the event of an accident, you could slide underneath the seat belt and sustain abdomen or neck injuries, for example. This poses an increased risk of injury or even fatal injury.

Adjust the seat properly before beginning your journey. Always ensure that the backrest is in an almost vertical position and that the shoulder section of your seat belt is routed across the center of your shoulder.

**!** To avoid damage to the seats and the seat heating, observe the following information:

- keep liquids from spilling on the seats. If liquid is spilled on the seats, dry them as soon as possible.
- if the seat covers are damp or wet, do not switch on the seat heating. The seat heating should also not be used to dry the seats.
- clean the seat covers as recommended; see the "Interior care" section.
- do not transport heavy loads on the seats. Do not place sharp objects on the seat cushions, e.g. knives, nails or tools. The seats should only be occupied by passengers, if possible.
- when the seat heating is in operation, do not cover the seats with insulating materials, e.g. blankets, coats, bags, seat covers, child seats or booster seats.

**!** Make sure that there are no objects in the footwell under or behind the seats when moving the seats back. There is a risk that the seats and/or the objects could be damaged.

**i** It is not possible to remove the head restraints from the front seats. The rear-compartment head restraints, however, can be removed. You can find information about this in the Digital Operator's Manual. For more information, contact a qualified specialist workshop.

**i** Further related subjects:

- Cargo compartment enlargement (folding down the rear bench seat)  
(▷ page 250)

### Information in the Digital Operator's Manual

In the Digital Operator's Manual you will find information on the following topics:

- Adjusting the seats
- Adjusting the head restraints
- Adjusting the rear seats (2nd and 3rd row of seats)
- Adjusting the multicontour seat
- Adjusting the 4-way lumbar support
- Switching the seat ventilation on/off

### Switching the seat heating on/off

#### Switching on/off

#### WARNING

Repeatedly switching on the seat heating can cause the seat cushion and backrest pads to become very hot. The health of persons with limited temperature sensitivity or a limited ability to react to excessively high temperatures may be affected or they may even suffer burn-like injuries. There is a risk of injury.

Therefore, do not switch the seat heating on repeatedly.

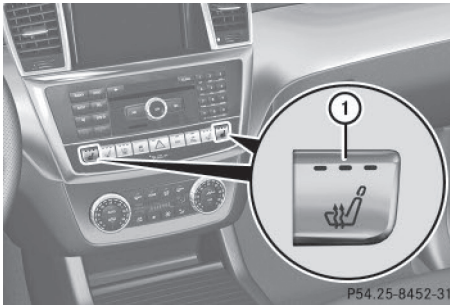

Driver's and front-passenger seat

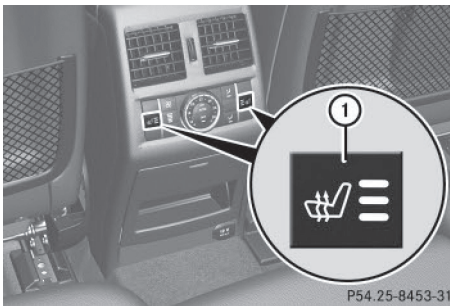

Rear seats

The three red indicator lamps in the button indicate the heating level you have selected.

The system automatically switches down from level **3** to level **2** after approximately eight minutes.

The system automatically switches down from level **2** to level **1** after approximately ten minutes.

The system automatically switches off approximately 35 minutes after it is set to level **1**.

- ▶ Turn the SmartKey to position **1** or **2** in the ignition lock (▷ page 135).
- ▶ **To switch on:** press button ① repeatedly until the desired heating level is set.
- ▶ **To switch off:** press button ① repeatedly until all the indicator lamps go out.

**i** If the battery voltage is too low, the seat heating may switch off.

### Problems with the seat heating

You can find information about this in the Digital Operator's Manual.

## Steering wheel

### Important safety notes

#### WARNING

You could lose control of your vehicle if you do the following while driving:

- adjust the driver's seat, head restraint, steering wheel or mirrors
- fasten the seat belt

There is a risk of an accident.

Adjust the driver's seat, head restraint, steering wheel and mirror and fasten your seat belt before starting the engine.

#### WARNING

Children could injure themselves if they adjust the steering wheel. There is a risk of injury.

When leaving the vehicle, always take the SmartKey with you and lock the vehicle. Never leave children unsupervised in the vehicle.

The electrically adjustable steering wheel can still be adjusted when there is no SmartKey in the ignition lock.

### Information in the Digital Operator's Manual

In the Digital Operator's Manual you will find information on the following topics:

- Adjusting the steering wheel
- Steering wheel heating
- EASY-ENTRY/EXIT feature

### Mirrors

In the Digital Operator's Manual you will find information on the following topics:

- Rear-view mirror
- Exterior mirrors
- Automatic anti-glare mirrors
- Parking position for the exterior mirror on the front-passenger side

### Memory function

In the Digital Operator's Manual you will find information on the following topics:

- Storing settings
- Calling up a stored setting

Useful information .....	114
Exterior lighting .....	114
Interior lighting .....	116
Replacing bulbs .....	116
Windshield wipers .....	119

### Useful information

- i** This Operator's Manual describes all models and all standard and optional equipment of your vehicle available at the time of publication of the Operator's Manual. Country-specific differences are possible. Please note that your vehicle may not be equipped with all features described. This also applies to safety-related systems and functions.
- i** Read the information on qualified specialist workshops (▷ page 35).

### Exterior lighting

#### General notes

For reasons of safety, Mercedes-Benz recommends that you drive with the lights switched on even during the daytime. In some countries, operation of the headlamps varies due to legal requirements and self-imposed obligations.

#### Information in the Digital Operator's Manual

In the Digital Operator's Manual you will find information on the following topics:

- Hazard warning lamps
- Headlamps fogged up on the inside

#### Setting the exterior lighting

##### Setting options

Exterior lighting can be set using:

- the light switch
- the combination switch (▷ page 115)
- the on-board computer

### Light switch

#### Operation

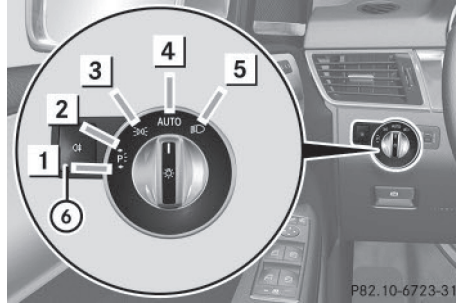

- 1** Left-hand standing lamps
- 2** Right-hand standing lamps
- 3** Parking lamps, license plate and instrument cluster lighting
- 4** **AUTO** Automatic headlamp mode, controlled by the light sensor
- 5** Low-beam/high-beam headlamps
- 6** Rear fog lamp

If you hear a warning tone when you leave the vehicle, the lights may still be switched on.

- ▶ Turn the light switch to **AUTO**.

The exterior lighting (except the parking/standing lamps) switches off automatically if you:

- remove the SmartKey from the ignition lock
- open the driver's door with the SmartKey in position **0**

### Combination switch

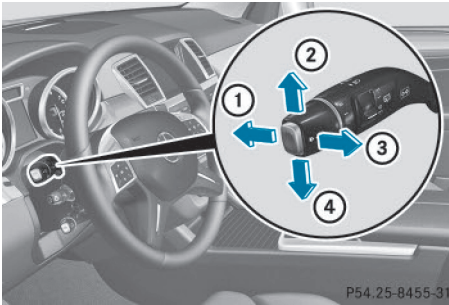

- ① High-beam headlamps
- ② Turn signal, right
- ③ High-beam flasher
- ④ Turn signal, left

In the Digital Operator's Manual you will find information on the following topics:

- Turn signal
- High-beam headlamps
- High-beam flasher

### Cornering light function



The cornering light function improves the illumination of the road over a wide angle in the direction you are turning, enabling better visibility in tight bends, for example. It can only be activated when the low-beam headlamps are switched on.

### Active:

- if you are driving at speeds below 25 mph (40 km/h) and switch on the turn signal or turn the steering wheel
- if you are driving at speeds between 25 mph (40 km/h) and 45 mph (70 km/h) and turn the steering wheel

The cornering lamp may remain lit for a short time, but is automatically switched off after no more than three minutes.

### Adaptive Highbeam Assist

#### General notes



You can use this function to set the headlamps to change between low beam and high beam automatically. The system recognizes vehicles with their lights on, either approaching from the opposite direction or traveling in front of your vehicle, and consequently switches the headlamps from high beam to low beam.

The system automatically adapts the low-beam headlamp range depending on the distance to the other vehicle. Once the system no longer detects any other vehicles, it reactivates the high-beam headlamps.



The system's optical sensor is located behind the windshield near the overhead control panel.

### Important safety notes

#### WARNING

Adaptive Highbeam Assist does not recognize road users:

- who have no lights, e.g. pedestrians
- who have poor lighting, e.g. cyclists
- whose lighting is blocked, e.g. by a barrier

In very rare cases, Adaptive Highbeam Assist may fail to recognize other road users that have lights, or may recognize them too late. In this or similar situations, the automatic high-beam headlamps will not be deactivated or activated regardless. There is a risk of an accident.



Always carefully observe the traffic conditions and switch off the high-beam headlamps in good time.

Adaptive Highbeam Assist cannot take into account road, weather or traffic conditions. Adaptive Highbeam Assist is only an aid. You are responsible for adjusting the vehicle's lighting to the prevailing light, visibility and traffic conditions.

In particular, the detection of obstacles can be restricted if there is:

- poor visibility, e.g. due to fog, heavy rain or snow
- dirt on the sensors or the sensors are obscured

### Switching Adaptive Highbeam Assist on/off

- ▶ **To switch on:** turn the light switch to .
- ▶ Press the combination switch beyond the pressure point in the direction of arrow ①. The  indicator lamp in the multifunction display lights up when it is dark and the light sensor activates the low-beam headlamps.



If you are driving at speeds above approximately 16 mph (25 km/h):

The headlamp range is set automatically depending on the distance between the vehicle and other road users.

If you are driving at speeds above approximately 19 mph (30 km/h) and no other road users have been detected:

The high-beam headlamps are switched on automatically. The  indicator lamp in the instrument cluster also lights up.

If you are driving at speeds below approximately 16 mph (25 km/h) or other road users have been detected or the roads are adequately lit:

The high-beam headlamps are switched off automatically. The  indicator lamp in the instrument cluster goes out. The  indicator lamp in the multifunction display remains lit.

- ▶ **To switch off:** move the combination switch back to its normal position or move the light switch to another position. The  indicator lamp in the multifunction display goes out.

### Interior lighting

An overview of the interior lighting and the overhead control panel can be found in the "At a glance" section.

In the Digital Operator's Manual you will find information on the following topics:

- Automatic interior lighting control
- Manual interior lighting control
- Crash-responsive emergency lighting

### Replacing bulbs

#### Important safety notes

#### DANGER

Xenon bulbs carry a high voltage. You can get an electric shock if you remove the cover of

the Xenon bulb and touch the electrical contacts. There is a risk of fatal injury.

Never touch the parts or the electrical contacts of the Xenon bulb. Always have work on the Xenon bulbs carried out at a qualified specialist workshop.

If your vehicle is equipped with Xenon bulbs, you can recognize this by the following: the cone of light from the Xenon bulbs moves from the top to the bottom and back again when you start the engine. For this to be observed, the lights must be switched on before starting the engine.

#### **WARNING**

Bulbs, lamps and connectors can get very hot when operating. If you change a bulb, you could burn yourself on these components. There is a risk of injury.

Allow these components to cool down before changing a bulb.

Do not use a bulb that has been dropped or if its glass tube has been scratched.

The bulb may explode if:

- you touch it
- it is hot
- you drop it
- you scratch it

Only operate bulbs in enclosed lamps designed for that purpose. Only install spare bulbs of the same type and the specified voltage.

Marks on the glass tube reduce the service life of the bulbs. Do not touch the glass tube with your bare hands. If necessary, clean the glass tube when cold with alcohol or spirit and rub it off with a lint-free cloth.

Protect bulbs from moisture during operation. Do not allow bulbs to come into contact with liquids.

There are bulbs other than the Xenon bulbs that you cannot change. Replace only the bulbs listed (> page 117). Have the bulbs that

you cannot replace yourself changed at a qualified specialist workshop.

If you require assistance changing bulbs, consult a qualified specialist workshop.

If the new bulb still does not light up, consult a qualified specialist workshop.

Bulbs and lamps are an important aspect of vehicle safety. You must therefore make sure that these function correctly at all times.

Have the headlamp setting checked regularly.

#### **Overview: changing bulbs/bulb types**

You can replace the following bulbs. The bulb type can be found in the legend.



Halogen headlamps

- ① Low-beam headlamp: H7 55 W
- ② High-beam headlamp: H7 55 W
- ③ Parking lamp/standing lamp: W 5 W BV
- ④ Side marker lamp: WY 5 W

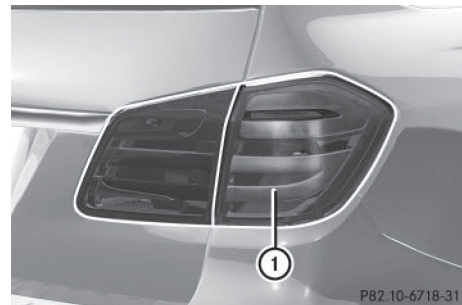

Tail lamps

- ① Brake lamp: P 21 W-L

### Changing the front bulbs

#### Removing and installing the cover in the front wheel housing

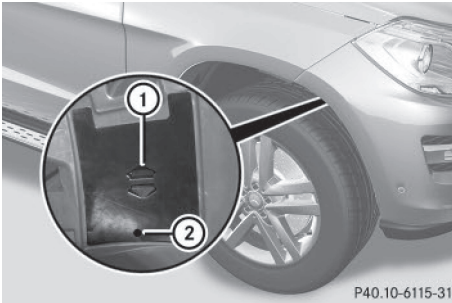

P40.10-6115-31

You must remove the cover from the front wheel housing before you can change the front bulbs.

- ▶ **To remove:** switch off the lights.
- ▶ Turn the front wheels inwards.
- ▶ Remove securing pin (2) using a suitable tool.
- ▶ Slide cover (1) up and remove it.
- ▶ **To install:** insert cover (1) again and slide it down until it engages.
- ▶ Insert securing pin (2).

#### Low-beam headlamps (halogen headlamps)

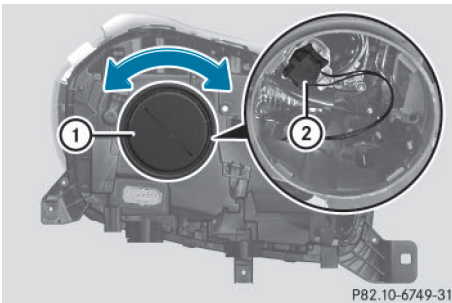

P82.10-6749-31

- ▶ Remove the cover in the front wheel housing (▷ page 118).
- ▶ Turn housing cover (1) counter-clockwise and remove it.

- ▶ Turn bulb holder (2) counter-clockwise and pull out.
- ▶ Pull the bulb out of bulb holder (2).
- ▶ Insert the new bulb into bulb holder (2).
- ▶ Insert bulb holder (2) and turn it clockwise.
- ▶ Press on housing cover (1) and turn it to the right.
- ▶ Replace the cover in the front wheel housing (▷ page 118).

#### High-beam headlamps (halogen headlamps)

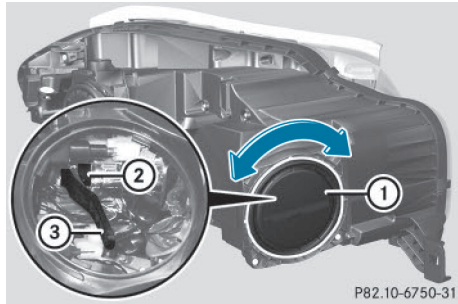

P82.10-6750-31

- ▶ Switch off the lights.
- ▶ Open the hood.
- ▶ Turn housing cover (1) counter-clockwise and remove it.
- ▶ Pull lever (3) upwards and remove bulb holder (2).
- ▶ Pull the bulb out of bulb holder (2).
- ▶ Insert the new bulb into bulb holder (2).
- ▶ Simultaneously press on bulb holder (2) and pull lever (3) downwards.
- ▶ Press on housing cover (1) and turn it clockwise.

**Changing the rear bulbs**

**Opening and closing the service flap**

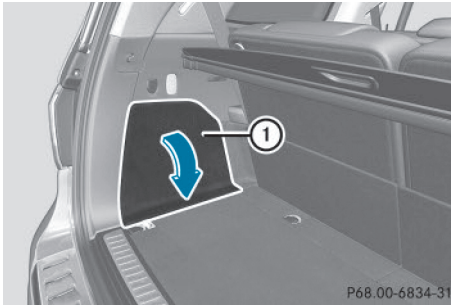

P68.00-6834-31

Left-hand service flap

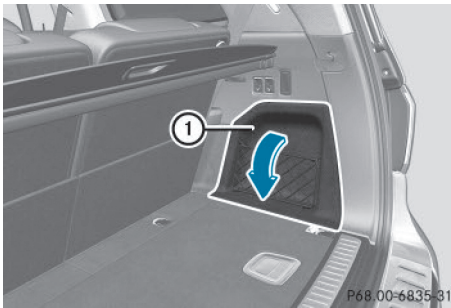

P68.00-6835-31

Right-hand service flap

You must open the service flap in the cargo compartment before you can change the bulbs in the brake lamp.

- ▶ **To open:** release service flap ① at the top, e.g. with a screwdriver, and swing it downward in the direction of the arrow.
- ▶ Right side: remove the first-aid kit beforehand and pull the parcel net down.
- ▶ **To close:** reinsert service flap ①.

**Brake lamp**

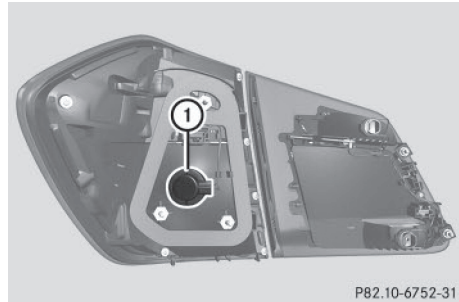

P82.10-6752-31

- ▶ Switch off the lights.
- ▶ Open the cargo compartment.
- ▶ Open the service flap (> page 119).
- ▶ Turn bulb holder ① counter-clockwise and remove it.
- ▶ Take bulb out of bulb holder ①.
- ▶ Insert the new bulb into bulb holder ①.
- ▶ Insert bulb holder ① into the lamp and turn it clockwise.
- ▶ Close the service flap (> page 119).

**Windshield wipers**



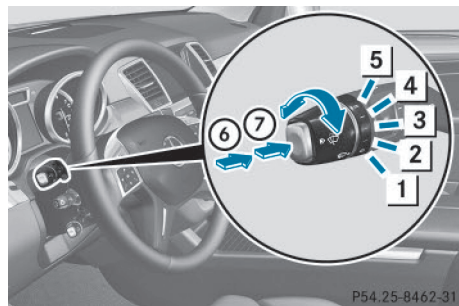

**Switching the windshield wipers on/off**



P54.25-8462-31

Combination switch

- 1 0 Windshield wiper off
- 2 ... Intermittent wipe, low (rain sensor set to low sensitivity)
- 3 .... Intermittent wipe, high (rain sensor set to high sensitivity)



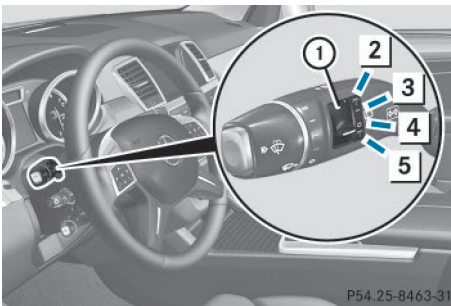

- 4  Continuous wipe, slow
- 5  Continuous wipe, fast
- 6  Single wipe
- 7  To wipe with washer fluid

If the wiper blades are worn, the windshield will no longer be wiped properly. This could prevent you from observing the traffic conditions.

### Switching the rear window wiper on/off



Combination switch

- ①  Rear window wiper switch
- ②  Wipes with washer fluid
- ③  Switches on intermittent wiping
- ④  Switches off intermittent wiping
- ⑤  Wipes with washer fluid

### Replacing the wiper blades

#### Important safety notes

#### WARNING

If the windshield wipers begin to move while you are changing the wiper blades, you could be trapped by the wiper arm. There is a risk of injury.

Always switch off the windshield wipers and ignition before changing the wiper blades.

-  To avoid damaging the wiper blades, make sure that you touch only the wiper arm of the wiper.

-  Never open the hood/tailgate if a wiper arm has been folded away from the windshield/rear window.

Never fold a windshield wiper arm without a wiper blade back onto the windshield/rear window.

Hold the windshield wiper arm firmly when you change the wiper blade. If you release the wiper arm without a wiper blade and it falls onto the windshield/rear window, the windshield/rear window may be damaged by the force of the impact.

Mercedes-Benz recommends that you have the wiper blades changed at a qualified specialist workshop.

### Changing the windshield wiper blades

#### Removing the wiper blades

- ▶ Remove the SmartKey from the ignition lock.
- ▶ Fold the wiper arm away from the windshield.

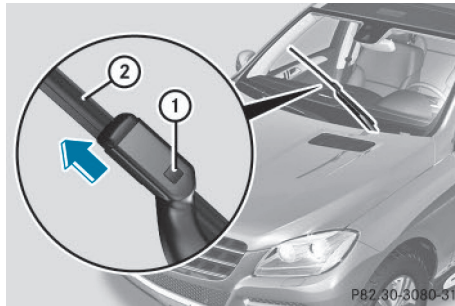

- ▶ Firmly press release knob ① and pull wiper blade ② upwards from the wiper arm in the direction of the arrow.



### Installing the wiper blades

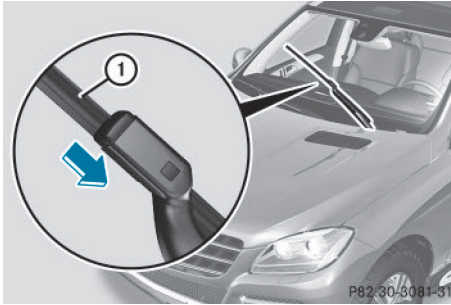

- ▶ Position new wiper blade ① in the retainer on the wiper arm and slide it into place in the direction of the arrow. The wiper blade audibly engages.
- ▶ Make sure that the wiper blade is seated correctly.
- ▶ Fold the wiper arm back onto the windshield.

### Replacing the rear window wiper blade

#### Removing a wiper blade

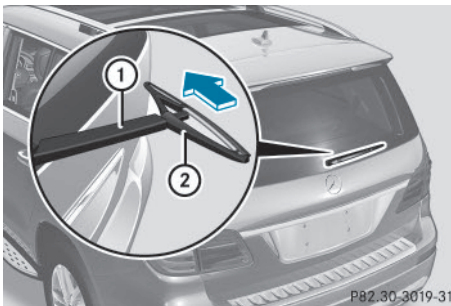

- ▶ Remove the SmartKey from the ignition lock.
- ▶ Fold wiper arm ① away from the rear window until it engages.
- ▶ Position wiper blade ② at a right angle to wiper arm ①.
- ▶ Hold wiper arm ① and press wiper blade ② in the direction of the arrow until it releases.
- ▶ Remove wiper blade ②.

#### Installing a wiper blade

- ▶ Place new wiper blade ② onto wiper arm ①.
- ▶ Hold wiper arm ① and press wiper blade ② in the opposite direction to the arrow until it engages.
- ▶ Make sure that wiper blade ② is seated correctly.
- ▶ Position wiper blade ② parallel to wiper arm ①.
- ▶ Fold wiper arm ① back onto the rear window.

### Problems with the windshield wipers

Problem	Possible causes/consequences and ► Solutions
The windshield wipers are jammed.	<p>Leaves or snow, for example, may be obstructing the windshield wiper movement. The wiper motor has been deactivated.</p> <ul style="list-style-type: none"> <li>► For safety reasons, you should remove the SmartKey from the ignition lock.</li> </ul> <p>or</p> <ul style="list-style-type: none"> <li>► Switch off the engine using the Start/Stop button and open the driver's door.</li> <li>► Remove the cause of the obstruction.</li> <li>► Switch the windshield wipers back on.</li> </ul>
The windshield wipers fail completely.	<p>The windshield wiper drive is malfunctioning.</p> <ul style="list-style-type: none"> <li>► Select another wiper speed on the combination switch.</li> <li>► Have the windshield wipers checked at a qualified specialist workshop.</li> </ul>



Useful information .....	124
Overview of climate control systems .....	124
Operating the climate control systems .....	131

### Useful information

- i** This Operator's Manual describes all models and all standard and optional equipment of your vehicle available at the time of publication of the Operator's Manual. Country-specific differences are possible. Please note that your vehicle may not be equipped with all features described. This also applies to safety-related systems and functions.
- i** Read the information on qualified specialist workshops (▷ page 35).

### Overview of climate control systems

#### General notes

Observe the settings recommended on the following pages. The windows could otherwise fog up.

To prevent the windows from fogging up:

- switch off climate control only briefly
- switch on air-recirculation mode only briefly
- switch on the cooling with air dehumidification function
- switch on the defrost windshield function briefly, if required

Climate control regulates the temperature and the humidity in the vehicle interior and filters undesirable substances out of the air.

Climate control can only be operated when the engine is running. Optimum operation is only achieved with the side windows and roof closed.

The residual heat function can only be activated or deactivated if the ignition is switched off. See the Digital Operator's Manual, keyword "Residual heat".

- i** Ventilate the vehicle for a brief period during warm weather, e.g. using the convenience opening feature.

This will speed up the cooling process and the desired interior temperature will be reached more quickly.

- i** The integrated filter filters out most particles of dust and soot and completely filters out pollen. It also reduces gaseous pollutants and odors. A clogged filter reduces the amount of air supplied to the vehicle interior. For this reason, you should always observe the interval for replacing the filter, which is specified in the Maintenance Booklet. As it depends on environmental conditions, e.g. heavy air pollution, the interval may be shorter than stated in the Maintenance Booklet.
- i** It is possible that under certain circumstances the residual heat function may be activated automatically an hour after the SmartKey has been removed in order to dry the automatic climate control. The vehicle is then ventilated for 30 minutes.

## Control panel for dual-zone automatic climate control

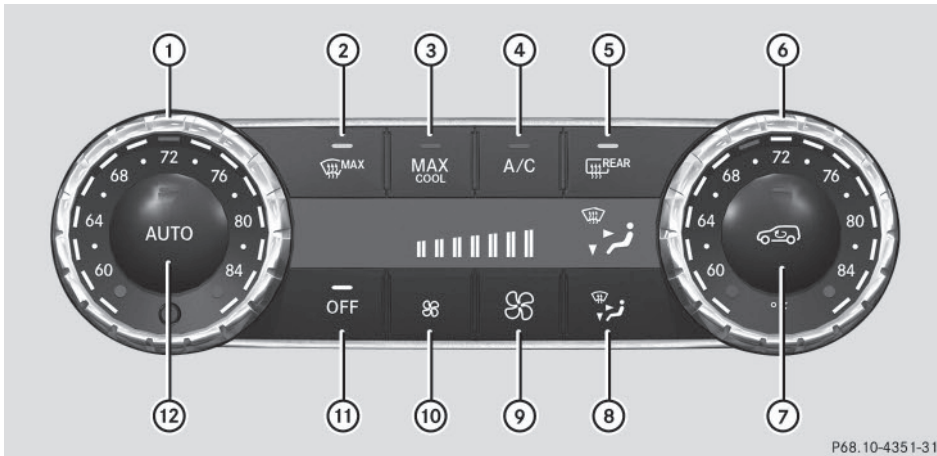

USA only

### Front control panel

- ① Sets the temperature, left
- ② Defrosts the windshield
- ③ Switches the maximum cooling MAX COOL on or off
- ④ Switches cooling with air dehumidification on/off
- ⑤ Switches the rear window defroster on/off
- ⑥ Sets the temperature, right
- ⑦ Switches air-recirculation mode on/off
- ⑧ Sets the air distribution
- ⑨ Increases the airflow
- ⑩ Reduces the airflow
- ⑪ Activates/deactivates the air conditioning
- ⑫ Sets climate control to automatic

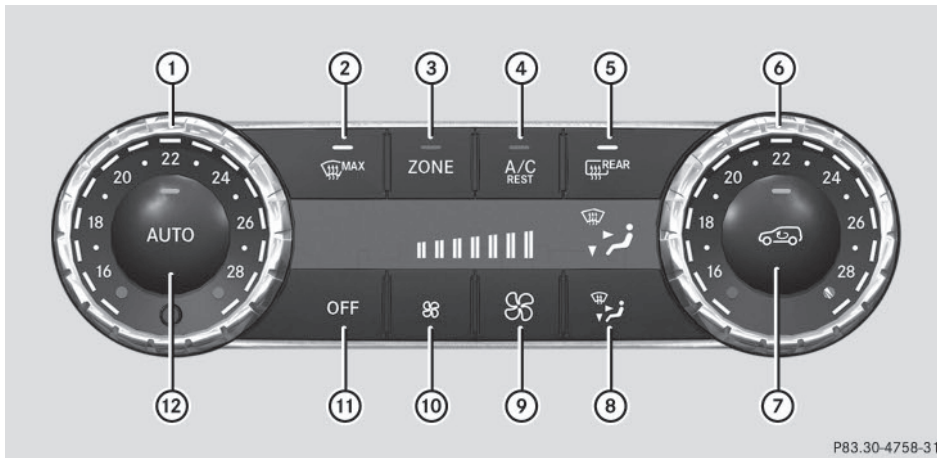

P83.30-4758-31

## Climate control

Canada only

**Front control panel**

- ① Sets the temperature, left
- ② Defrosts the windshield
- ③ Switches the ZONE function on/off
- ④ Switches cooling with air dehumidification on/off  
Switches the residual heat on or off
- ⑤ Switches the rear window defroster on/off
- ⑥ Sets the temperature, right
- ⑦ Switches air-recirculation mode on/off
- ⑧ Sets the air distribution
- ⑨ Increases the airflow
- ⑩ Reduces the airflow
- ⑪ Activates/deactivates the air conditioning
- ⑫ Sets climate control to automatic

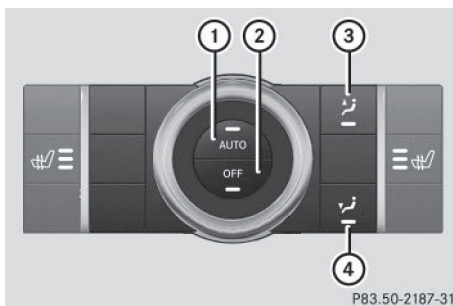

P83.50-2187-31

**Rear control panel**

- ① Sets rear-compartment climate control to automatic
- ② Switches the rear climate control on/off

- ③ Directs the airflow through the rear air vents
- ④ Directs the airflow through the footwell vents

**Control panel for 3-zone automatic climate control**

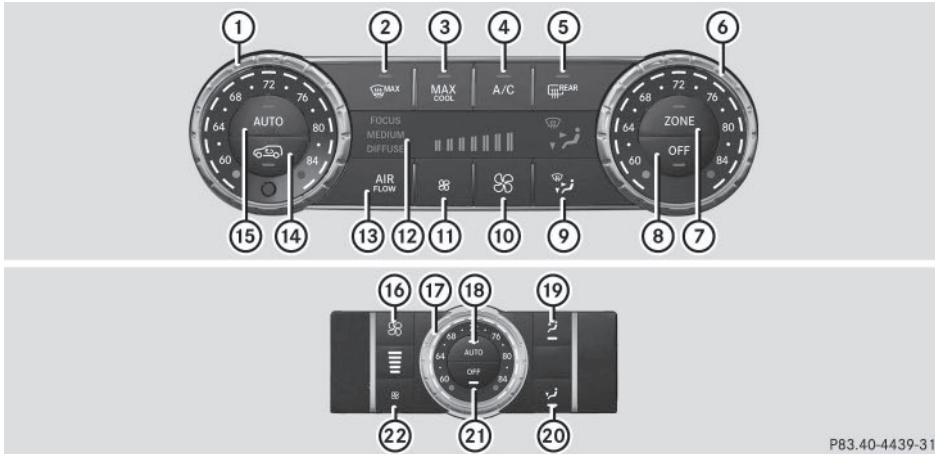

P83.40-4439-31

USA only

**Front control panel**

- ① Sets the temperature, left
- ② Defrosts the windshield
- ③ Switches the maximum cooling MAX COOL on or off
- ④ Switches cooling with air dehumidification on/off
- ⑤ Switches the rear window defroster on/off
- ⑥ Sets the temperature, right
- ⑦ Switches the ZONE function on/off
- ⑧ Activates/deactivates the air conditioning
- ⑨ Sets the air distribution
- ⑩ Increases the airflow
- ⑪ Reduces the airflow
- ⑫ Display
- ⑬ Adjusts the climate mode settings
- ⑭ Switches air-recirculation mode on/off
- ⑮ Sets climate control to automatic

**Rear control panel**

- ⑯ Increases the airflow
- ⑰ Sets the temperature
- ⑱ Sets rear-compartment climate control to automatic
- ⑲ Directs the airflow through the rear air vents

- ⑳ Directs the airflow through the footwell vents
- ㉑ Switches the rear climate control on/off
- ㉒ Reduces the airflow

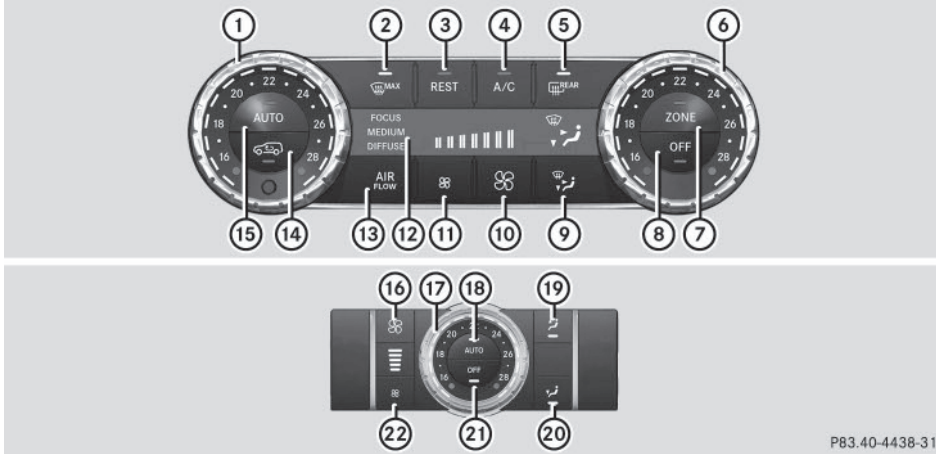

P83.40-4438-31

Canada only

**Front control panel**

- ① Sets the temperature, left
- ② Defrosts the windshield
- ③ Switches the residual heat on or off
- ④ Switches cooling with air dehumidification on/off
- ⑤ Switches the rear window defroster on/off
- ⑥ Sets the temperature, right
- ⑦ Switches the ZONE function on/off
- ⑧ Activates/deactivates the air conditioning
- ⑨ Sets the air distribution
- ⑩ Increases the airflow
- ⑪ Reduces the airflow
- ⑫ Display
- ⑬ Adjusts the climate mode settings
- ⑭ Switches air-recirculation mode on/off
- ⑮ Sets climate control to automatic

**Rear control panel**

- ⑯ Increases the airflow
- ⑰ Sets the temperature
- ⑱ Sets rear-compartment climate control to automatic
- ⑲ Directs the airflow through the rear air vents
- ⑳ Directs the airflow through the footwell vents

- ⑰ Switches the rear climate control on/off
- ⑱ Reduces the airflow

**Control panel for 3-zone automatic climate control with additional rear-compartment climate control**

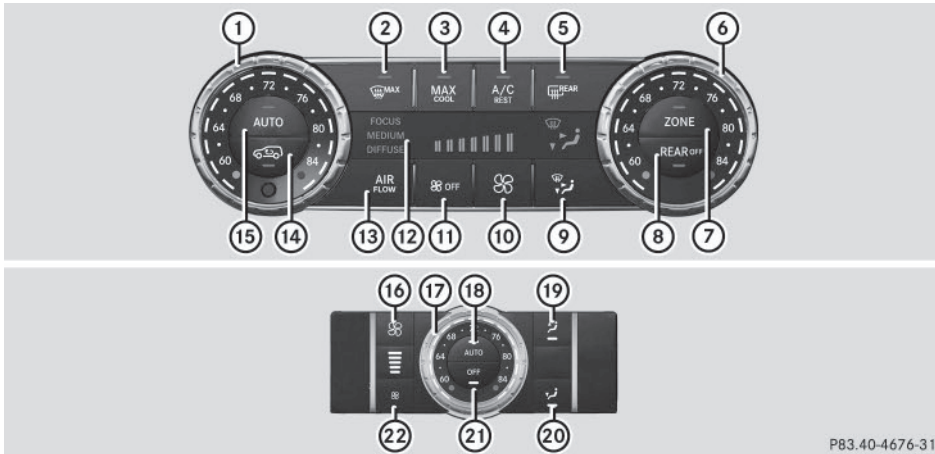

PB3.40-4676-31

Climate control

USA only

**Front control panel**

- ① Sets the temperature, left
- ② Defrosts the windshield
- ③ Switches the maximum cooling MAX COOL on or off
- ④ Switches cooling with air dehumidification on/off  
Switches the residual heat on or off
- ⑤ Switches the rear window defroster on/off
- ⑥ Sets the temperature, right
- ⑦ Switches the ZONE function on/off
- ⑧ Switches the rear climate control on/off
- ⑨ Sets the air distribution
- ⑩ Increases the airflow
- ⑪ Reduces the airflow  
Switches off climate control
- ⑫ Display
- ⑬ Adjusts the climate mode settings
- ⑭ Switches air-recirculation mode on/off
- ⑮ Sets climate control to automatic

**Rear control panel**

- ⑯ Increases the airflow



- ⑰ Sets the temperature
- ⑱ Sets rear-compartment climate control to automatic
- ⑲ Directs the airflow through the rear air vents
- ⑳ Directs the airflow through the footwell vents
- ㉑ Switches the rear climate control on/off
- ㉒ Reduces the airflow

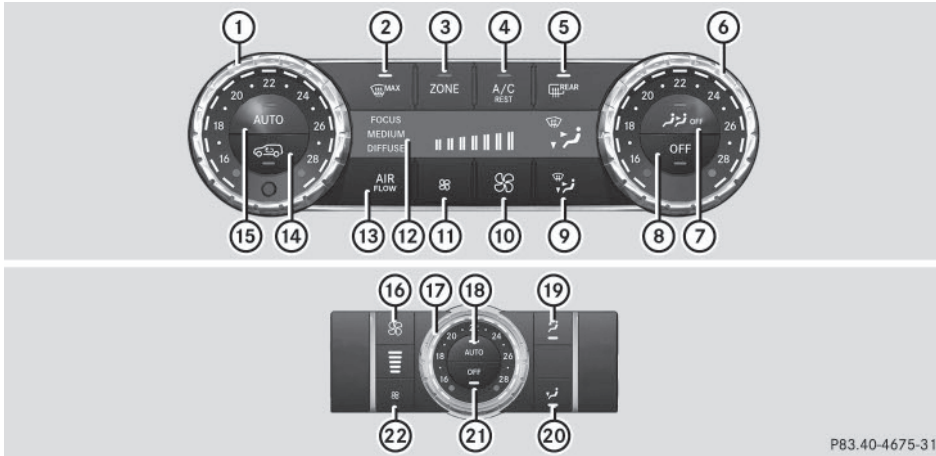

P83.40-4675-31

Canada only

**Front control panel**

- ① Sets the temperature, left
- ② Defrosts the windshield
- ③ Switches the ZONE function on/off
- ④ Switches cooling with air dehumidification on/off  
Switches the residual heat on or off
- ⑤ Switches the rear window defroster on/off
- ⑥ Sets the temperature, right
- ⑦ Switches the rear climate control on/off
- ⑧ Activates/deactivates the air conditioning
- ⑨ Sets the air distribution
- ⑩ Increases the airflow
- ⑪ Reduces the airflow
- ⑫ Display
- ⑬ Adjusts the climate mode settings
- ⑭ Switches air-recirculation mode on/off
- ⑮ Sets climate control to automatic

**Rear control panel**

- ⑯ Increases the airflow
- ⑰ Sets the temperature

- ⑱ Sets rear-compartment climate control to automatic
- ⑲ Directs the airflow through the rear air vents
- ⑳ Directs the airflow through the footwell vents
- ㉑ Switches the rear climate control on/off
- ㉒ Reduces the airflow

### Operating the climate control systems

In the Digital Operator's Manual you will find information on the following topics:

- Activating/deactivating climate control
- Switching cooling with air dehumidification on/off
- Setting climate control to automatic
- Adjusting the climate mode settings
- Setting the temperature
- Setting the air distribution
- Setting the airflow
- Switching the ZONE function on/off
- Defrosting the windshield
- MAX COOL maximum cooling
- Defrosting the windows
- Switching the rear window defroster on/off
- Switching air-recirculation mode on/off
- Switching the residual heat on or off
- Setting the air vents



Useful information .....	134
Notes on breaking-in a new vehicle .....	134
Driving .....	134
Automatic transmission .....	140
Refueling .....	142
Parking .....	148
Driving tips .....	150
Driving systems .....	155
Towing a trailer .....	190

### Useful information

- i** This Operator's Manual describes all models and all standard and optional equipment of your vehicle available at the time of publication of the Operator's Manual. Country-specific differences are possible. Please note that your vehicle may not be equipped with all features described. This also applies to safety-related systems and functions.
- i** Read the information on qualified specialist workshops (▷ page 35).

### Notes on breaking-in a new vehicle

#### Important safety notes

The sensor system of some driving and driving safety systems adjusts automatically while a certain distance is being driven after the vehicle has been delivered or after repairs. Full system effectiveness is not reached until the end of this teach-in procedure.

New and replaced brake pads and discs only reach their optimum braking effect after several hundred kilometers of driving. Compensate for this by applying greater force to the brake pedal.

#### The first 1000 miles (1500 km)

The more you look after the engine when it is new, the more satisfied you will be with its performance in the future.

- You should therefore drive at varying vehicle and engine speeds for the first 1000 miles (1500 km).
- Avoid heavy loads, e.g. driving at full throttle, during this period.
- Change gear in good time, before the tachometer needle is  $\frac{2}{3}$  of the way to the red area of the tachometer.

- Do not manually shift to a lower gear to brake the vehicle.
- Try to avoid depressing the accelerator pedal beyond the point of resistance (kick-down).

After 1000 miles (1500 km), you can increase the engine speed gradually and accelerate the vehicle to full speed.

Additional breaking-in notes for Mercedes-AMG vehicles:

- Do not drive faster than 85 mph (140 km/h) for the first 1,000 miles (1,500 km).
- Only allow the engine to reach a maximum engine speed of 4,500 rpm briefly.
- Change gear in good time.
- Ideally, for the first 1,000 miles (1,500 km), drive in program **C**.

You should also observe these notes on breaking in if the engine or parts of the drive train on your vehicle have been replaced.

Always observe the maximum permissible speed.

### Driving

#### Important safety notes

#### WARNING

Objects in the driver's footwell can restrict the pedal travel or obstruct a depressed pedal. The operating and road safety of the vehicle is jeopardized. There is a risk of an accident.

Make sure that all objects in the vehicle are stowed correctly, and that they cannot enter the driver's footwell. Install the floor mats securely and as specified in order to ensure sufficient clearance for the pedals. Do not use loose floor mats and do not place floor mats on top of one another.

**⚠ WARNING**

Unsuitable footwear can hinder correct usage of the pedals, e.g.:

- shoes with thick soles
- shoes with high heels
- slippers

There is a risk of an accident.

Wear suitable footwear to ensure correct usage of the pedals.

**⚠ WARNING**

If you switch off the ignition while driving, safety-relevant functions are only available with limitations, or not at all. This could affect, for example, the power steering and the brake boosting effect. You will require considerably more effort to steer and brake. There is a risk of an accident.

Do not switch off the ignition while driving.

**⚠ WARNING**

If the parking brake has not been fully released when driving, the parking brake can:

- overheat and cause a fire
- lose its hold function.

There is a risk of fire and an accident. Release the parking brake fully before driving off.

**!** Do not warm up the engine with the vehicle stationary. Drive off immediately. Avoid high engine speeds and driving at full throttle until the engine has reached its operating temperature.

Only shift the automatic transmission to the desired drive position when the vehicle is stationary.

Where possible, avoid spinning the drive wheels when pulling away on slippery roads. You could otherwise damage the drive train.

**!** **Mercedes-AMG vehicles:** at low engine oil temperatures below 68 °F (+20 °C), the maximum engine speed is restricted in order to protect the engine. To protect the

engine and maintain smooth engine operation, avoid driving at full throttle when the engine is cold.

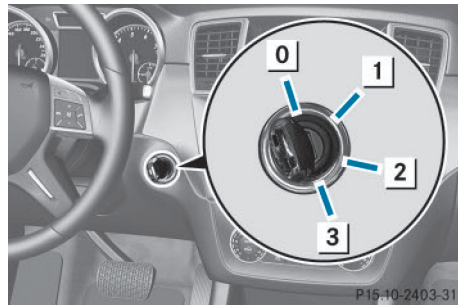
**SmartKey positions****SmartKey**

- 0** To remove the SmartKey
  - 1** Power supply for some consumers, such as the windshield wipers
  - 2** Ignition (power supply for all consumers) and drive position
  - 3** To start the engine
- i** The SmartKey can be turned in the ignition lock even if it is not the correct SmartKey for the vehicle. The ignition is not switched on. The engine cannot be started.

**KEYLESS-GO****General notes**

Vehicles with KEYLESS-GO are equipped with a SmartKey featuring an integrated KEYLESS-GO function and a detachable Start/Stop button.

A check which periodically establishes a radio connection between the vehicle and the SmartKey determines whether a valid SmartKey is in the vehicle. This occurs, for example, when starting the engine.

When you insert the Start/Stop button into the ignition lock, the system needs approximately two seconds recognition time. You can then use the Start/Stop button.

Pressing the Start/Stop button several times in succession corresponds to the different key positions in the ignition lock. This is only the case if you are not depressing the brake pedal.

If you depress the brake pedal and press the Start/Stop button, the engine starts immediately.

To start the vehicle without actively using the SmartKey:

- the Start/Stop button must be inserted in the ignition lock.
- the SmartKey must be in the vehicle.
- the vehicle must not be locked with the SmartKey or KEYLESS-GO (▷ page 89).

Do not keep the SmartKey:

- with electronic devices, e.g. a mobile phone or another SmartKey.
- with metallic objects, e.g. coins or metal foil.
- inside metallic objects, e.g. a metal case.

This can impair the functionality of the KEYLESS-GO key.

Do not keep the KEYLESS-GO key in the temperature-controlled cup holder (▷ page 255). Otherwise, the KEYLESS-GO key will not be recognized.

If you lock the vehicle with the SmartKey's remote control or with KEYLESS-GO, after a short time:

- you will not be able to switch on the ignition with the Start/Stop button.
- you will not be able to start the engine with the Start/Stop button until the vehicle is unlocked again.

If you lock the vehicle centrally using the button on the front door (▷ page 95), you can continue to start the engine with the Start/Stop button.

The engine can be switched off while the vehicle is in motion by pressing and holding the Start/Stop button for three seconds. This function operates independently of the ECO

start/stop automatic engine switch-off function.

### Key positions with KEYLESS-GO

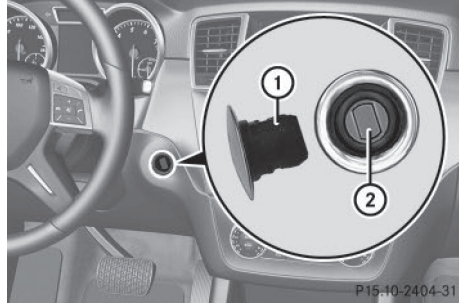

- ① Start/Stop button
- ② Ignition lock

As soon as the ignition is switched on, all the indicator lamps in the instrument cluster light up. Further information on situations where an indicator lamp either fails to go out after starting the engine or lights up while driving (▷ page 216).

If Start/Stop button ① has not yet been pressed, this corresponds to the key being removed from the ignition.

► **To switch on the power supply:** press Start/Stop button ① once.

The power supply is switched on. You can now activate the windshield wipers, for example.

The power supply is switched off again if:

- the driver's door is opened and
- you press Start/Stop button ① twice when in this position

► **To switch on the ignition:** press Start/Stop button ① twice.

The ignition is switched on.

If you press Start/Stop button ① once when in this position, the ignition is deactivated again.

### Removing the Start/Stop button

You can remove the Start/Stop button from the ignition lock and start the vehicle as normal using the SmartKey.



It is only possible to switch between KEY-LESS-GO mode and SmartKey operation when the transmission is in position **P**.

- ▶ Remove Start/Stop button ① from ignition lock ②.

You do not have to remove the Start/Stop button from the ignition lock when you leave the vehicle. You should, however, always take the SmartKey with you when leaving the vehicle. As long as the SmartKey is in the vehicle:

- the vehicle can be started using the Start/Stop button
- the electrically powered equipment can be operated

### Starting the engine

#### Important safety notes

##### **WARNING**

If children are left unsupervised in the vehicle, they could:

- open the doors, thus endangering other people or road users.
- get out and disrupt traffic.
- operate the vehicle's equipment.

Additionally, children could set the vehicle in motion if, for example, they:

- release the parking brake.
- shifting the automatic transmission out of park position **P**
- Start the engine.

There is a risk of an accident and injury.

When leaving the vehicle, always take the SmartKey with you and lock the vehicle. Never leave children or animals unattended in the vehicle. Always keep the SmartKey out of reach of children.

##### **WARNING**

Combustion engines emit poisonous exhaust gases such as carbon monoxide. Inhaling these exhaust gases leads to poisoning. There is a risk of fatal injury. Therefore never leave

the engine running in enclosed spaces without sufficient ventilation.

##### **WARNING**

Flammable materials introduced through environmental influence or by animals can ignite if in contact with the exhaust system or parts of the engine that heat up. There is a risk of fire.

Carry out regular checks to make sure that there are no flammable foreign materials in the engine compartment or in the exhaust system.

- ❗ Do not depress the accelerator when starting the engine.

#### General notes

**Vehicles with a gasoline engine:** the catalytic converter is preheated for up to 30 seconds after a cold start. The sound of the engine may change during this time.

#### Automatic transmission

- ▶ Shift the transmission to position **P**. You can find information about this in the Digital Operator's Manual.

The transmission position display in the multifunction display shows **P**. You can find information about this in the Digital Operator's Manual.

-  You can start the engine in transmission position **P** and **N**.

#### Starting procedure with the SmartKey

- ▶ **To start a diesel engine:** turn the SmartKey to position **2** in the ignition lock (▷ page 135).

The  preglow indicator lamp in the instrument cluster lights up.

- ▶ Turn the SmartKey to position **3** in the ignition lock and release it as soon as the engine is running (▷ page 135).

- i Vehicles with a diesel engine:** you can start the engine without preglow if the engine is warm.

### Using KEYLESS-GO to start the engine

The Start/Stop button can be used to start the vehicle without inserting the SmartKey into the ignition lock. The Start/Stop button must be inserted in the ignition lock and the SmartKey must be in the vehicle. This mode for starting the engine operates independently of the ECO start/stop automatic engine start function.

- ▶ Depress the brake pedal and keep it depressed.
- ▶ Press the Start/Stop button once (▷ page 135).

**Vehicles with a gasoline engine:** the engine starts.

**Vehicles with a diesel engine:** preglow is activated and the engine starts.

### Pulling away

#### General notes

#### WARNING

If the engine speed is above the idling speed and you engage transmission position **D** or **R**, the vehicle could pull away suddenly. There is a risk of an accident.

When engaging transmission position **D** or **R**, always firmly depress the brake pedal and do not simultaneously accelerate.

Depress the accelerator carefully when pulling away.

The vehicle locks centrally once you have pulled away. The locking knobs in the doors drop down.

You can open the doors from the inside at any time.

You can also deactivate the automatic locking feature (▷ page 199).

It is only possible to shift the transmission from position **P** to the desired position if you depress the brake pedal. Only then is the parking lock released. If you do not depress the brake pedal, the DIRECT SELECT lever can still be moved but the parking lock remains engaged.

- i** Upshifts take place at higher engine speeds after a cold start. This helps the catalytic converter to reach its operating temperature more quickly.

Information on the automatic release of the electric parking brake can be found in the Digital Operator's Manual.

### Pulling away with a trailer



To ensure that you do not roll backwards when pulling away on an uphill slope, engage the electric parking brake.

- ▶ Press and hold handle ①.
  - The electric parking brake continues to brake and prevent the vehicle from rolling backwards.
  - The red **PARK** (USA only) or **(P)** (Canada only) indicator lamp in the instrument cluster remains on.
- ▶ Depress the accelerator pedal.
- ▶ As soon as the vehicle/trailer combination is held by the driving force of the engine, release lever ①.
  - The electric parking brake is released.
  - The red **PARK** (USA only) or **(P)** (Canada only) indicator lamp in the instrument cluster goes out.

## Hill start assist

Hill start assist helps you when pulling away forwards or in reverse on an uphill gradient. It holds the vehicle for a short time after you have removed your foot from the brake pedal. This gives you enough time to move your foot from the brake pedal to the accelerator pedal and to depress it before the vehicle begins to roll.

### WARNING

After a short time, hill start assist will no longer brake your vehicle and it could roll away. There is a risk of an accident and injury.

Therefore, quickly move your foot from the brake pedal to the accelerator pedal. Never leave the vehicle when it is held by hill start assist.

Hill start assist is not active if:

- you are pulling away on a level road or on a downhill gradient.
- the transmission is in position **N**.
- the electric parking brake is applied.
- ESP® is malfunctioning.

## ECO start/stop function

### Introduction

The ECO start/stop function switches the engine off automatically if the vehicle is stopped under certain conditions.

The engine starts automatically when the driver wants to pull away again. The ECO start/stop function thereby helps you to reduce the fuel consumption and emissions of your vehicle.

### Important safety notes

#### WARNING

If the engine is switched off automatically and you exit the vehicle, the engine is restarted automatically. The vehicle may begin moving. There is a risk of accident and injury.

If you wish to exit the vehicle, always turn off the ignition and secure the vehicle against rolling away.

### General notes

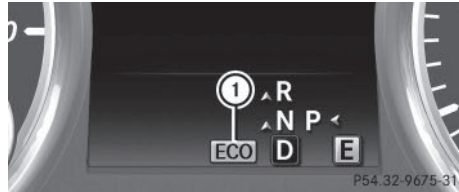

#### ① ECO start/stop display

The ECO start/stop function is activated whenever you start the engine using the SmartKey or the Start/Stop button.

If the engine has been switched off automatically by the ECO start/stop function, the **ECO** symbol is shown in the multifunction display.

**Mercedes-AMG vehicles:** the ECO start/stop function is only available in drive program **C**.

### Information in the Digital Operator's Manual

In the Digital Operator's Manual you will find information on the following topics:

- Automatic engine switch-off
- Automatic engine start
- Deactivating or activating the ECO start/stop function

### Problems with the engine

You can find information about this in the Digital Operator's Manual.

## Automatic transmission

### Important safety notes

#### WARNING

If the engine speed is above the idling speed and you engage transmission position **D** or **R**, the vehicle could pull away suddenly. There is a risk of an accident.

When engaging transmission position **D** or **R**, always firmly depress the brake pedal and do not simultaneously accelerate.

#### WARNING

The automatic transmission switches to neutral position **N** when you switch off the engine. The vehicle may roll away. There is a risk of an accident.

After switching off the engine, always switch to parking position **P**. Prevent the parked vehicle from rolling away by applying the parking brake.

### DIRECT SELECT lever

#### Overview of transmission positions

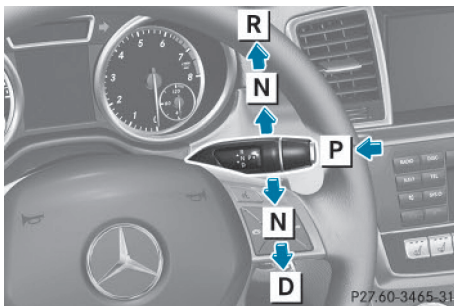

- P** Park position with parking lock
- R** Reverse gear
- N** Neutral
- D** Drive

The DIRECT SELECT lever is on the right of the steering column.

The DIRECT SELECT lever always returns to its original position. The current transmission

position **P**, **R**, **N** or **D** appears in the transmission position display in the multifunction display. You can find information about this in the Digital Operator's Manual.

### Information in the Digital Operator's Manual

In the Digital Operator's Manual you will find information on the following topics:

- Transmission position and drive program display
- Engaging park position P
- Engaging park position P automatically
- Engaging reverse gear R
- Engaging drive position D

### Shifting to neutral N

#### WARNING

If children are left unsupervised in the vehicle, they could:

- open the doors, thus endangering other people or road users.
- get out and disrupt traffic.
- operate the vehicle's equipment.

Additionally, children could set the vehicle in motion if, for example, they:

- release the parking brake.
- shifting the automatic transmission out of park position **P**
- Start the engine.

There is a risk of an accident and injury.

When leaving the vehicle, always take the SmartKey with you and lock the vehicle. Never leave children or animals unattended in the vehicle. Always keep the SmartKey out of reach of children.

- ▶ If the transmission is in position **D** or **R**: push the DIRECT SELECT lever up or down to the first point of resistance.
- ▶ If the transmission is in position **P**: depress the brake pedal and push the DIRECT

SELECT lever up or down to the first point of resistance.

If you switch the engine off with the transmission in position **R** or **D**, the automatic transmission shifts to **N** automatically.

**With the SmartKey:** if you then open the driver's door or the front-passenger door or remove the SmartKey from the ignition, the automatic transmission shifts to **P** automatically.

**With the Start/Stop button:** if you then open the driver's door or the front-passenger door, the automatic transmission shifts to **P** automatically.

If you want the automatic transmission to remain in neutral **N**, e.g. when having the vehicle cleaned in an automatic car wash with a towing system:

**Using the SmartKey:**

- ▶ Switch on the ignition.
- ▶ Depress the brake pedal and keep it depressed.
- ▶ Shift to neutral **N**.
- ▶ Release the brake pedal.
- ▶ Release the electric parking brake.
- ▶ Switch off the ignition and leave the SmartKey in the ignition lock.

**With the Start/Stop button:**

- ▶ Remove the Start/Stop button from the ignition lock.
- ▶ Insert the SmartKey into the ignition lock.
- ▶ Switch on the ignition.
- ▶ Depress the brake pedal and keep it depressed.
- ▶ Shift to neutral **N**.
- ▶ Release the brake pedal.
- ▶ Release the electric parking brake.
- ▶ Switch off the ignition and leave the SmartKey in the ignition lock.

### Information in the Digital Operator's Manual

In the Digital Operator's Manual you will find information on the following topics:

- Transmission positions
- Driving tips
- Program selector button
- Steering wheel paddle shifters
- Automatic drive program (Mercedes-AMG vehicles)
- Problems with the transmission

### Manual drive program

#### General information

In this drive program, you can permanently change gear yourself by using the steering wheel paddle shifters. The transmission must be in position **D**.

- i In addition to permanent drive program **M**, you can also activate temporary drive program **M**; see the Digital Operator's Manual.

#### Switching on the manual drive program

In manual drive program **M**, you can change gear using the steering wheel paddle shifters if the transmission is in position **D**. You can see the currently selected drive program and which gear is engaged in the multifunction display.

- ▶ **Vehicles with the ON&OFFROAD package:** press the program selector button; see Digital Operator's Manual.
- ▶ **Mercedes-AMG vehicles:** press the program selector button repeatedly until **M** appears in the multifunction display; see the Digital Operator's Manual.

### Upshifting (all vehicles except Mercedes-AMG vehicles)



- ▶ If relevant gearshift recommendation ① appears in the multifunction display on the instrument cluster, pull on the right-hand steering wheel paddle shifter (see the Digital Operator's Manual). The automatic transmission shifts to recommended gear ②.

### Upshifting (Mercedes-AMG vehicles)

- ❗ In manual drive program **M**, the automatic transmission does not shift up automatically even when the engine limiting speed for the current gear is reached. When the engine limiting speed is reached, the fuel supply is cut to prevent the engine from overrevving. Always make sure that the engine speed does not reach the red area of the tachometer. There is otherwise a risk of engine damage.



- ① Gear indicator
- ② Upshift indicator

Before the engine speed reaches the red area, an upshift indicator will be shown in the multifunction display.

- ▶ When the **UP** message appears in the multifunction display, pull on the right-hand steering wheel paddle shifter.

### Information in the Digital Operator's Manual

In the Digital Operator's Manual you will find information on the following topics:

- Downshifting
- Kickdown
- Switching off the manual drive program

### Transfer case

- ❗ Performance tests may only be carried out on a 2-axle dynamometer. The brake system or transfer case could otherwise be damaged. Contact a qualified specialist workshop for a performance test.

- ❗ Because ESP® is an automatic system, the engine and ignition must be switched off (SmartKey in position **0** or **1** or Start/Stop button in position **0** or **1**) when the electric parking brake is being tested on a brake dynamometer (maximum 10 seconds).

Braking triggered automatically by ESP® may seriously damage the brake system.

- ❗ Vehicles with 4MATIC must not be towed with either the front or the rear axle raised, as doing so will damage the transmission.

This section is only valid for vehicles with 4-wheel drive (4MATIC). Power is always transmitted to both axles.

### Refueling

#### Important safety notes

#### ⚠ WARNING

Fuel is highly flammable. If you handle fuel incorrectly, there is a risk of fire and explosion.

You must avoid fire, open flames, creating sparks and smoking. Switch off the engine and, if applicable, the auxiliary heating before refueling.

**⚠ WARNING**

Fuel is poisonous and hazardous to health. There is a risk of injury.

You must make sure that fuel does not come into contact with your skin, eyes or clothing and that it is not swallowed. Do not inhale fuel vapors. Keep fuel away from children.

If you or others come into contact with fuel, observe the following:

- Wash away fuel from skin immediately using soap and water.
- If fuel comes into contact with your eyes, immediately rinse them thoroughly with clean water. Seek medical assistance without delay.
- If fuel is swallowed, seek medical assistance without delay. Do not induce vomiting.
- Immediately change out of clothing which has come into contact with fuel.

**⚠ WARNING**

Electrostatic buildup can create sparks and ignite fuel vapors. There is a risk of fire and explosion.

Always touch the vehicle body before opening the fuel filler flap or touching the fuel pump nozzle. Any existing electrostatic buildup is thereby discharged.

**⚠ WARNING**

Vehicles with a diesel engine:

If you mix diesel fuel with gasoline, the flash point is lower than that of pure diesel fuel. When the engine is running, exhaust system components could overheat without being noticed. There is a risk of fire.

Never refuel with gasoline. Never mix gasoline with diesel fuel.

- !** Do not use gasoline to refuel vehicles with a diesel engine. Do not switch on the ignition if you accidentally refuel with the wrong fuel. Otherwise, the fuel will enter the fuel system. Even small amounts of the

wrong fuel could result in damage to the fuel system and the engine. The repair costs are high. Notify a qualified specialist workshop and have the fuel tank and fuel lines drained completely.

- !** Do not use diesel to refuel vehicles with a gasoline engine. Do not switch on the ignition if you accidentally refuel with the wrong fuel. Otherwise, the fuel will enter the fuel system. Even small amounts of the wrong fuel could result in damage to the fuel system and the engine. Notify a qualified specialist workshop and have the fuel tank and fuel lines drained completely.

- !** Overfilling the fuel tank could damage the fuel system.

- !** Take care not to spill any fuel on painted surfaces. You could otherwise damage the paintwork.

- !** Use a filter when refueling from a fuel can. Otherwise, the fuel lines and/or injection system could be blocked by particles from the fuel can.

Do not get into the vehicle again during the refueling process. Otherwise, electrostatic charge could build up again.

If you overfill the fuel tank, fuel could spray out when the fuel pump nozzle is removed.

For further information on fuel and fuel quality (> page 333).

You will find further information on fuel and fuel quality in the printed Operator's Manual under "Technical data".

**Refueling****General information**

Pay attention to the important safety notes (> page 142).

The fuel filler flap is unlocked or locked automatically when you unlock or lock the vehicle with the SmartKey or using KEYLESS-GO.



The position of the fuel filler cap is displayed  in the instrument cluster. The arrow next to the filling pump indicates the side of the vehicle.

### Opening the fuel filler flap

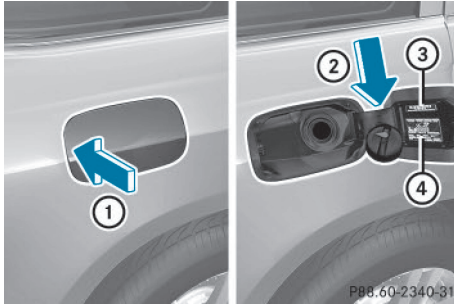

- ① To open the fuel filler flap
  - ② To insert the fuel filler cap
  - ③ Instruction label for fuel type to be refueled
  - ④ Tire pressure table
- ▶ Switch off the engine.
  - ▶ Remove the SmartKey from the ignition lock.
- or, on vehicles with KEYLESS-GO:
- ▶ Open the driver's door.  
The on-board electronics now have status **0**. This is the same as the SmartKey having been removed.  
The driver's door can be closed again.
  - ▶ Press the fuel filler flap in the direction of arrow ①.  
The fuel filler flap swings up.
  - ▶ Turn the fuel filler cap counterclockwise and remove it.
  - ▶ Insert the fuel filler cap into the holder bracket on the inside of filler flap ②.
  - ▶ Completely insert the filler neck of the fuel pump nozzle into the tank, hook in place and refuel.
  - ▶ Only fill the tank until the pump nozzle switches off.

Do not add any more fuel after the pump stops filling for the first time. Otherwise, fuel may leak out.

Vehicles with a diesel engine: the filler neck is designed for refueling at diesel filling pumps.

### Closing the fuel filler flap

- ▶ Replace the cap on the filler neck and turn clockwise until it engages audibly.
- ▶ Close the fuel filler flap.

Close the fuel filler flap before locking the vehicle.

If you are driving with the fuel filler cap open, the  reserve fuel warning lamp flashes. A message appears in the multifunction display (▷ page 201).

In addition, the  Check Engine warning lamp may light up (▷ page 214).

### Problems with fuel and the fuel tank

This section provides descriptions of and solutions to safety-relevant problems. Descriptions of and solutions to further problems can be found in the Digital Operator's Manual.

Problem	Possible causes/consequences and ► Solutions
Fuel is leaking from the vehicle.	<p> <b>WARNING</b></p> <p>The fuel line or the fuel tank is faulty. Risk of explosion or fire.</p> <ul style="list-style-type: none"> <li>► Apply the electric parking brake.</li> <li>► Switch off the engine.</li> <li>► Remove the SmartKey from the ignition lock.</li> </ul> <p>or, on vehicles with KEYLESS-GO:</p> <ul style="list-style-type: none"> <li>► Open the driver's door. The on-board electronics now have status <b>0</b>. This is the same as the SmartKey having been removed.</li> <li>► Do not restart the engine under any circumstances.</li> <li>► Consult a qualified specialist workshop.</li> </ul>

### DEF (BlueTEC vehicles only)

#### Important notes on use

To function properly, BlueTEC exhaust gas aftertreatment must be operated with the reducing agent DEF. Adding DEF is one of the tasks performed during maintenance. Under normal operating conditions, a tank of DEF lasts until the next service due date.

When the supply of DEF is almost used up, the **Check Additive See Operator's Manual** message is shown in the multifunction display.

If you drive the vehicle faster than 10 mph (16 km/h), the **Check Additive See Operator's Manual** message goes out after approximately one minute.

When the supply of DEF is down to a reserve of approximately 1 gal (3.8 l) the **Refill DEF See Operator's Manual** message is shown in the multifunction display.

When the DEF supply drops to a minimum, the **Remaining Starts: 16** message is shown in the multifunction display.

If the **Refill DEF No Start in XXXX km** message is shown in the multifunction display, you can still drive the vehicle over the distance shown. If DEF is not refilled, you will subsequently be **unable to start the engine**. If the **Refill DEF Eng. Start Not Poss.** message appears in the multifunction display and the engine does not start, you must add DEF.

- Add at least 1 gal (3.8 l) of DEF.
- Switch on the ignition for at least 60 seconds.
- Start the engine.

 Have the DEF tank refilled at a qualified specialist workshop.

Use the special DEF refill bottle when adding DEF between maintenance intervals. Contact an authorized Mercedes-Benz Center with any questions or, if necessary, contact Roadside Assistance (▷ page 32).

If the outside temperature is below 12 °F (-11 °C) it may be difficult to top up. If DEF is frozen and there is an active warning indicator, it may not be possible to add DEF. Park

the vehicle in a warmer place, e.g. in a garage, until DEF has become fluid again. It will then be possible to add DEF again. Alternatively, have the DEF tank refilled at a qualified specialist workshop.

Further information about BlueTEC exhaust gas aftertreatment and DEF is available at any authorized Mercedes-Benz Center.

### Important safety notes

DEF is a water-soluble fluid for the exhaust gas aftertreatment of diesel engines. It is:

- not poisonous
- colorless and odorless
- not flammable

When you open the DEF container, small amounts of ammonia vapor may be released. Ammonia vapors have a pungent odor and are particularly irritating to the skin, to mucous membranes and to the eyes. You may experience a burning sensation in your eyes, nose and throat. Coughing and watering of the eyes are possible.

Do not inhale ammonia vapors. Fill the DEF tank only in well-ventilated areas.

DEF must not come into contact with your skin, eyes or clothing and must not be swallowed. Keep DEF away from children.

If you or other persons come into contact with DEF, observe the following:

- Rinse DEF from your skin immediately with soap and water.
- If DEF comes into contact with your eyes, immediately rinse them thoroughly with clean water. Seek medical assistance without delay.
- If DEF has been swallowed, rinse your mouth out immediately. Drink plenty of water. Seek medical assistance without delay.
- Change out of clothing contaminated with DEF immediately.

**!** Only use DEF in accordance with ISO 2224 1. Do not mix any additives with

DEF, and do not dilute DEF with water. This may destroy the BlueTEC exhaust gas aftertreatment system.

**!** The vehicle must be parked on level ground to fill the DEF tank. The DEF tank can only be filled as intended with the vehicle parked on a level surface. This avoids false level readings. Filling the tank is not permitted if the vehicle is not parked on a level surface. There is a danger of overfilling, which could result in damage to components of the BlueTEC exhaust gas aftertreatment.

**!** Rinse surfaces that have come into contact with DEF immediately with water or remove DEF using a damp cloth and cold water. If the DEF has already crystallized, use a sponge and cold water to clean it. DEF residues crystallize after time and contaminate the affected surfaces.

**!** DEF is not a fuel additive and must not be added to the fuel tank. If DEF is added to the fuel tank, this can lead to engine damage.

For further information on DEF, see (> page 336).

### Opening the DEF filler cap

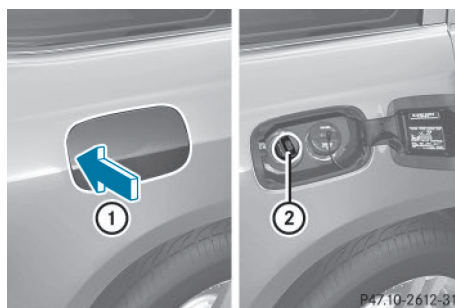

The fuel filler flap is unlocked or locked automatically when you open or close the vehicle with the SmartKey or with KEYLESS-GO.

- ▶ Switch the ignition off.
- ▶ Press the fuel filler flap in the direction of arrow ①.  
The fuel filler flap swings up.
- ▶ Turn blue DEF fuel filler cap ② counter-clockwise and remove it.  
DEF filler cap ② is secured with a plastic strip.

### DEF refill canisters

- ❗ Do not tighten the disposable hose with too much force. The disposable hose may otherwise be destroyed.

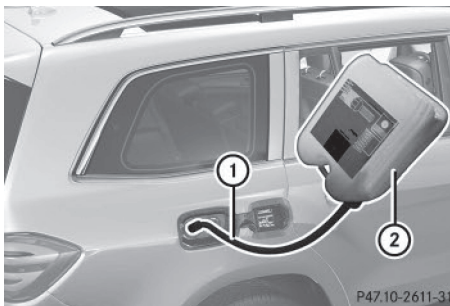
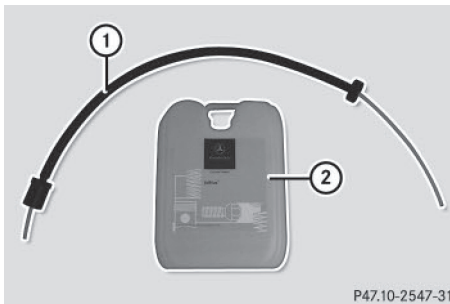

- ▶ Unscrew the cap from the opening on top of DEF refill canister ②.
- ▶ Place disposable hose ① on the opening of DEF refill canister ② and screw it on clockwise until hand-tight.
- ❗ Disposable hose ① remains closed until you fasten disposable hose ① to the DEF filler neck of the vehicle.
- ▶ Place disposable hose ① on the filler neck on the vehicle and screw it on clockwise

until hand-tight. When you feel resistance, disposable hose ① is sufficiently secured.

- ▶ Lift up and tip DEF refill canister ②.
- ❗ Filling stops when the DEF tank is completely filled. Do not fill the DEF tank any further. DEF refill canister ② can be removed when it has been only partially emptied.
- ▶ Turn disposable hose ① on the filler neck of the vehicle counter-clockwise and remove it.
- ▶ Turn disposable hose ① on the opening of DEF refill canister ② counter-clockwise and remove it.
- ▶ Reseal DEF refill canister ② with the cap.

DEF refill canisters can be obtained at many gas stations or at an authorized Mercedes-Benz Center. DEF refill canisters are often sold with a filler hose. A filler hose that does not exactly fit the vehicle's DEF tank offers no protection against overfilling. DEF may leak if overfilled. Mercedes-Benz offers a special disposable hose with overflow protection. You can obtain this from any authorized Mercedes-Benz Center. DEF is available in a variety of containers and receptacles. Only use the disposable hose with the Mercedes-Benz DEF refill canisters.

### DEF refill bottle

- ❗ Only screw on the DEF refill bottle hand-tight. It could otherwise be damaged.

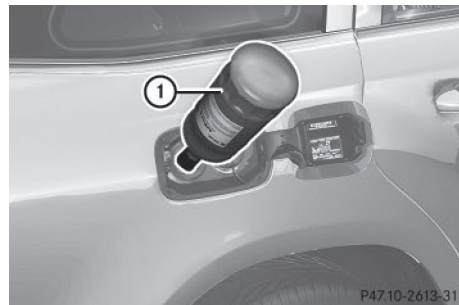

- ▶ Unscrew the protective cap from DEF refill bottle ①.
- ▶ Place DEF refill bottle ① on the filler neck as shown and screw it on clockwise until hand-tight.
- ▶ Press DEF refill bottle ① towards the filler neck.  
The DEF tank is filled. This may take up to one minute.
- ❗ When DEF refill bottle ① is no longer pressed, filling stops and the bottle may be taken off again after being only partially emptied.
- ▶ Release DEF refill bottle ①.
- ▶ Turn DEF refill bottle ① counter-clockwise and remove it.
- ▶ Screw the protective cap onto DEF refill bottle ① again.

DEF refill bottles can be obtained at many gas stations or at an authorized Mercedes-Benz Center. Refill bottles without a threaded cap do not provide overfill protection. DEF may leak if overfilled. Mercedes-Benz offers special refill bottles with a threaded seal. These are available at any authorized Mercedes-Benz Center.

### Closing the DEF filler cap

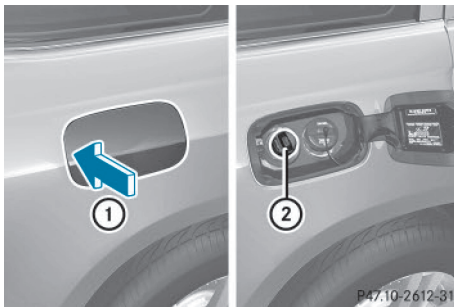

- ▶ Install DEF filler cap ② on the filler neck and turn it clockwise.
- ▶ To close the fuel filler flap, press it in the direction of arrow ①.
- ▶ Drive faster than 10 mph (16 km/h).  
The **Check Additive See Operator's Manual** message goes out after approximately one minute.

❗ If the **Check Additive See Operator's Manual** message continues to be shown in the multifunction display, you must add more DEF.

## Parking

### Important safety notes

#### ⚠ WARNING

Flammable material such as leaves, grass or twigs may ignite if they come into contact with hot parts of the exhaust system or exhaust gas flow. There is a risk of fire.

Park the vehicle so that no flammable materials come into contact with parts of the vehicle which are hot. Take particular care not to park on dry grassland or harvested grain fields.

#### ⚠ WARNING

If you switch off the ignition while driving, safety-relevant functions are only available with limitations, or not at all. This could affect, for example, the power steering and the brake boosting effect. You will require considerably more effort to steer and brake. There is a risk of an accident.

Do not switch off the ignition while driving.

#### ⚠ WARNING

If you leave children unsupervised in the vehicle, they could set it in motion by, for example:

- release the parking brake.
- shift the automatic transmission out of the parking position **P**.
- start the engine.

In addition, they may operate vehicle equipment and become trapped. There is a risk of an accident and injury.

When leaving the vehicle, always take the SmartKey with you and lock the vehicle. Never leave children unsupervised in the vehicle.

- ❗ Always secure the vehicle correctly against rolling away. Otherwise, the vehicle or its drivetrain could be damaged.

To ensure that the vehicle is secured against rolling away unintentionally:

- the electric parking brake must be applied.
- the transmission must be in position **P** and the SmartKey must be removed from the ignition lock.
- the front wheels must be turned towards the curb on steep uphill or downhill gradients.
- the empty vehicle must be secured at the front axle with a wheel chock or similar, for example, on uphill or downhill gradients.
- a laden vehicle must also be secured at the rear axle with a wheel chock or similar, for example, on uphill or downhill gradients.

### Switching off the engine

#### Important safety notes

##### **WARNING**

The automatic transmission switches to neutral position **N** when you switch off the engine. The vehicle may roll away. There is a risk of an accident.

After switching off the engine, always switch to parking position **P**. Prevent the parked vehicle from rolling away by applying the parking brake.

#### Information in the Digital Operator's Manual

A description of how to switch off the engine can be found in the Digital Operator's Manual.

### Electric parking brake

#### General notes

##### **WARNING**

If you leave children unsupervised in the vehicle, they could set it in motion by, for example:

- release the parking brake.
- shift the automatic transmission out of the parking position **P**.
- start the engine.

In addition, they may operate vehicle equipment and become trapped. There is a risk of an accident and injury.

When leaving the vehicle, always take the SmartKey with you and lock the vehicle. Never leave children unsupervised in the vehicle.

The function of the electric parking brake is dependent on the on-board voltage. If the on-board voltage is low or there is a malfunction in the system, it may not be possible to apply the released parking brake.

- ▶ If this is the case, only park the vehicle on level ground and secure it to prevent it rolling away.
- ▶ Shift the automatic transmission to position **P**.

It may not be possible to release an applied parking brake if the on-board voltage is low or there is a malfunction in the system. Contact a qualified specialist workshop.

- ❗ The electric parking brake performs a function test at regular intervals while the engine is switched off. The sounds that can be heard while this is occurring are normal.

#### Information in the Digital Operator's Manual

In the Digital Operator's Manual you will find information on the following topics:

- Applying or releasing manually
- Applying automatically

- Releasing automatically
- Emergency braking

#### Parking the vehicle for a long period

You can find information about this in the Digital Operator's Manual.

#### Driving tips

#### General notes

#### Important safety notes

##### WARNING

If you switch off the ignition while driving, safety-relevant functions are only available with limitations, or not at all. This could affect, for example, the power steering and the brake boosting effect. You will require considerably more effort to steer and brake. There is a risk of an accident.

Do not switch off the ignition while driving.

##### WARNING

If you operate mobile communication equipment while driving, you will be distracted from traffic conditions. You could also lose control of the vehicle. There is a risk of an accident.

Only operate this equipment when the vehicle is stationary.

Observe the legal requirements for the country in which you are driving. Some jurisdictions prohibit the driver from using a mobile phone while driving a vehicle.

If you make a call while driving, always use hands-free mode. Only operate the telephone when the traffic situation permits. If you are unsure, pull over to a safe location and stop before operating the telephone.

Bear in mind that at a speed of only 30 mph (approximately 50 km/h) the vehicle covers a distance of 44 ft (approximately 14 m) per second.

#### Drive sensibly – save fuel

Observe the following tips to save fuel:

- ▶ The tires should always be inflated to the recommended tire pressure.
- ▶ Remove unnecessary loads.
- ▶ Remove roof carriers when they are not needed.
- ▶ Warm up the engine at low engine speeds.
- ▶ Avoid frequent acceleration or braking.
- ▶ Have all maintenance work carried out as indicated by the service intervals in the Maintenance Booklet or by the service interval display.

Fuel consumption also increases when driving in cold weather, in stop-start traffic and in hilly terrain.

#### Drinking and driving

##### WARNING

Drinking and driving and/or taking drugs and driving are very dangerous combinations. Even a small amount of alcohol or drugs can affect your reflexes, perceptions and judgment.

The possibility of a serious or even fatal accident is greatly increased when you drink or take drugs and drive.

Do not drink or take drugs and drive or allow anyone to drive who has been drinking or taking drugs.

#### Emission control

##### WARNING

Combustion engines emit poisonous exhaust gases such as carbon monoxide. Inhaling these exhaust gases leads to poisoning. There is a risk of fatal injury. Therefore never leave the engine running in enclosed spaces without sufficient ventilation.

Certain engine systems are designed to keep the level of poisonous components in exhaust fumes within legal limits.



These systems only work at peak efficiency if they are serviced exactly in accordance with the manufacturer's specifications. For this reason, all work on the engine must be carried out by qualified and authorized Mercedes-Benz technicians.

The engine settings must not be changed under any circumstances. Furthermore, all specific service work must be carried out at regular intervals and in accordance with the Mercedes-Benz service requirements. Details can be found in the Maintenance Booklet.

### ECO display

You can find information about this in the Digital Operator's Manual.

### Braking

#### Important safety notes

##### WARNING

If you shift down on a slippery road surface in an attempt to increase the engine's braking effect, the drive wheels could lose their grip. There is an increased danger of skidding and accidents.

Do not shift down for additional engine braking on a slippery road surface.

#### Downhill gradients

You can find information about this in the Digital Operator's Manual.

#### Heavy and light loads

##### WARNING

If you rest your foot on the brake pedal while driving, the braking system can overheat. This increases the stopping distance and can even cause the braking system to fail. There is a risk of an accident.

Never use the brake pedal as a footrest. Never depress the brake pedal and the accelerator pedal at the same time.

Further information can be found in the Digital Operator's Manual.

#### Wet roads

You can find information about this in the Digital Operator's Manual.

#### Limited braking performance on salt-treated roads

You can find information about this in the Digital Operator's Manual.

#### Servicing the brakes

You can find information about this in the Digital Operator's Manual.

#### High-performance brake system (Mercedes-AMG vehicles)

You can find information about this in the Digital Operator's Manual.

#### Driving on wet roads

#### Information in the Digital Operator's Manual

In the Digital Operator's Manual you will find information on the following topics:

- Hydroplaning
- Driving on flooded roads
- Off-road fording

Always observe the fording depth values (▷ page 341).

#### Winter driving

##### WARNING

If you shift down on a slippery road surface in an attempt to increase the engine's braking

effect, the drive wheels could lose their grip. There is an increased danger of skidding and accidents.

Do not shift down for additional engine braking on a slippery road surface.

#### **DANGER**

If the exhaust pipe is blocked or adequate ventilation is not possible, poisonous gases such as carbon monoxide (CO) may enter the vehicle. This is the case, e.g. if the vehicle becomes trapped in snow. There is a risk of fatal injury.

If you leave the engine or the auxiliary heating running, make sure the exhaust pipe and area around the vehicle are clear of snow. To ensure an adequate supply of fresh air, open a window on the side of the vehicle that is not facing into the wind.

Further information can be found in the Digital Operator's Manual.

### Off-road driving

#### Important safety notes

#### **WARNING**

If you drive on a steep incline at an angle or turn when driving on an incline, the vehicle could slip sideways, tip and rollover. There is a risk of an accident.

Always drive on a steep incline in the line of fall (straight up or down) and do not turn the vehicle.

#### **WARNING**

Flammable material such as leaves, grass or twigs may ignite if they come into contact with hot parts of the exhaust system. There is a risk of fire.

When driving off road or on unpaved roads, check the vehicle's underside regularly. In particular, remove parts of plants or other flammable materials which have become

trapped. In the case of damage, contact a qualified specialist workshop.

#### **WARNING**

If the vehicle level is high, the vehicle center of gravity is raised. This could cause the vehicle to tip over more easily on uphill or downhill gradients. There is a risk of an accident.

Select the lowest possible vehicle level.

 There is a risk of damage to the vehicle if:

- the vehicle becomes stuck, e.g. on a high curb or an unpaved road
- you drive too fast over an obstacle, e.g. a curb or a hole in the road
- a heavy object strikes the undercarriage or parts of the chassis

In situations like this, the body, the undercarriage, chassis parts, wheels or tires could be damaged without the damage being visible. Components damaged in this way can unexpectedly fail or, in the case of an accident, no longer withstand the strain they are designed to.

If the underbody paneling is damaged, combustible materials such as leaves, grass or twigs can gather between the underbody and the underbody paneling. If these materials come in contact with hot parts of the exhaust system, they can catch fire.

In such situations, have the vehicle checked and repaired immediately at a qualified specialist workshop. If on continuing your journey you notice that driving safety is impaired, pull over and stop the vehicle immediately, paying attention to road and traffic conditions. In such cases, consult a qualified specialist workshop.

When driving off-road, substances such as sand, mud and water or water mixed with oil may get into the brakes. This could result in a reduced braking effect or in total brake failure and also in increased wear and tear. The braking characteristics change depending on the material ingressing the brakes. Clean the

brakes after driving off-road. If you detect a reduced braking effect or grinding noises, have the brake system checked in a qualified specialist workshop as soon as possible.

Adapt your driving style to the different braking characteristics.

Driving off-road increases the likelihood of damage to the vehicle, which, in turn, can lead to failure of the mechanical assembly or systems. Adapt your driving style to suit the terrain conditions. Drive carefully. Have damage to the vehicle rectified immediately at a qualified specialist workshop.

Do not switch to transmission position **N** when driving off-road. If you try to brake the vehicle using the service brake, you could lose control of the vehicle. If the gradient is too steep for your vehicle, drive back down in reverse gear.

### General notes

You can find information about this in the Digital Operator's Manual.

### Checklist before driving off-road

❗ If the engine oil warning lamp lights up while the vehicle is in motion, stop the vehicle in a safe place as soon as possible. Check the engine oil level. The engine oil warning lamp warning must not be ignored. Continuing the journey while the symbol is displayed could lead to engine damage.

- ▶ **Engine oil level:** check the engine oil level and add oil if necessary.

When driving on steep gradients, the engine oil level must be sufficiently high to ensure a correct oil supply in the vehicle.

- ▶ **DEF tank (BlueTEC vehicles):** check the level and add if necessary (▷ page 145).
- ▶ **Tire-changing tool kit:** check that the jack is working and make sure you have the lug wrench, a robust tow cable and a folding spade in the vehicle.
- ▶ **Wheels and tires:** check the tire tread depth and tire pressure.

- ▶ Check for damage and remove any foreign objects, e.g. small stones, from the wheels/tires.
- ▶ Replace any missing valve caps.
- ▶ Replace dented or damaged wheels.
- ▶ **Rims:** dented or bent rims can result in a loss of tire pressure and damage the tire bead. Before driving off-road, check the wheels and replace them if necessary.

### Checklist after driving off-road

❗ If you detect damage to the vehicle after driving off-road, have the vehicle checked immediately at a qualified specialist workshop.

Driving over rough terrain places greater demands on your vehicle than driving on normal roads. After driving off-road, check the vehicle. This allows you to detect damage promptly and reduce the risk of an accident to yourself and other road users.

- ▶ **Vehicles with the ON&OFFROAD package:** activate the on-road program. You can find information about this in the Digital Operator's Manual.
- ▶ Deactivate the LOW RANGE off-road gear. You can find information about this in the Digital Operator's Manual.
- ▶ Deactivate DSR. You can find information about this in the Digital Operator's Manual.
- ▶ Lower the vehicle level again to a level suitable to the road conditions, e.g. to the highway level.
- ▶ Clean the headlamps and rear lights and check for damage.
- ▶ Clean the front and rear license plates.
- ▶ Clean the wheels and tires with a water jet and remove any foreign objects.
- ▶ Clean the wheels, wheel housings and the vehicle underside with a water jet; check for any foreign objects and damage.
- ▶ Check whether twigs or other parts of plants have become trapped. These increase the risk of fire and can damage

fuel pipes, brake hoses or the rubber bellows of the axle joints and propeller shafts.

- ▶ After the trip, examine without fail the entire undercarriage, wheels, tires, brakes, bodywork structure, steering, chassis and exhaust system for damage.
- ▶ After driving for extended periods across sand, mud, gravel, water or in similarly dirty conditions, have the brake discs, wheels, brake pads/linings and axle joints checked and cleaned.
- ▶ If you detect strong vibrations after off-road travel, check for foreign objects in the wheels and drive train and remove them if necessary. Foreign objects can disturb the balance and cause vibrations.

### Driving on sand

You can find information about this in the Digital Operator's Manual.

### Tire ruts and gravel roads

You can find information about this in the Digital Operator's Manual.

### Driving over obstacles

You can find information about this in the Digital Operator's Manual.

## Traveling uphill

### Approach/departure angle

#### WARNING

If you drive on a steep incline at an angle or turn when driving on an incline, the vehicle could slip sideways, tip and rollover. There is a risk of an accident.

Always drive on a steep incline in the line of fall (straight up or down) and do not turn the vehicle.

- Observe the rules on off-road driving.
- Do not drive at an angle on slopes, inclines or gradients, but instead follow the direct line of fall.
- When driving down an incline, make use of the engine's braking effect. Observe the engine speed; do not overrev the engine.
- Before driving on extreme uphill and downhill gradients, select the LOW RANGE off-road gear (▷ page 188).
- Drive slowly.
- Avoid high engine speeds. Drive at appropriate engine speeds (maximum 3,000 rpm).
- Use the left-hand steering wheel paddle shifter to shift into a lower gear in good time on long and steep downhill gradients.
- Check the brakes after prolonged off-road driving.

Hill start assist will aid you when pulling away on a hill. For further information about hill start assist, see (▷ page 139).

Do not switch to transmission position **N** when driving off-road. If you try to brake the vehicle using the service brake, you could lose control of the vehicle. If the gradient is too steep for your vehicle, drive back down in reverse gear.

Always observe the approach/departure angle values (▷ page 342).

### Maximum gradient-climbing capability

Always observe the maximum gradient climbing ability values (▷ page 343).

### Hilltops

You can find information about this in the Digital Operator's Manual.

### Driving downhill

You can find information about this in the Digital Operator's Manual.

## Driving systems

### Intelligent Drive

Mercedes-Benz Intelligent Drive stands for innovative driver assistance and safety systems which enhance comfort and support the driver in critical situations. With these intelligent co-ordinated systems Mercedes-Benz has set a milestone on the path towards autonomous driving.

Mercedes-Benz Intelligent Drive embraces all elements of active and passive safety in one well thought out system – for the safety of the vehicle occupants and that of other road users.

Further information on driving safety systems (▷ page 74).

### Cruise control

#### General notes

Cruise control maintains a constant road speed for you. It brakes automatically in order to avoid exceeding the set speed. You must select a lower gear in good time on long and steep downhill gradients, especially if the vehicle is laden or towing a trailer. By doing so, you will make use of the braking effect of the engine. This relieves the load on the brake system and prevents the brakes from overheating and wearing too quickly.

Use cruise control only if road and traffic conditions make it appropriate to maintain a steady speed for a prolonged period. You can store any road speed above 20 mph (30 km/h).

- i** Cruise control should not be activated when driving off-road.

#### Important safety notes

If you fail to adapt your driving style, cruise control can neither reduce the risk of an accident nor override the laws of physics. Cruise control cannot take into account the road, traffic and weather conditions. Cruise control

is only an aid. You are responsible for the distance to the vehicle in front, for vehicle speed, for braking in good time and for staying in your lane.

Do not use cruise control:

- in road and traffic conditions which do not allow you to maintain a constant speed e.g. in heavy traffic or on winding roads
- on slippery road surfaces. Braking or accelerating could cause the drive wheels to lose traction and the vehicle could then skid
- when there is poor visibility, e.g. due to fog, heavy rain or snow

If there is a change of drivers, advise the new driver of the speed stored.

#### Cruise control lever

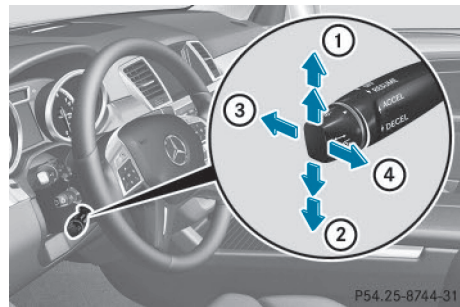

- ① To activate or increase speed
- ② To activate or reduce speed
- ③ To deactivate cruise control
- ④ To activate at the current speed/last stored speed

When you activate cruise control, the stored speed is shown in the multifunction display for five seconds.

#### Information in the Digital Operator's Manual

In the Digital Operator's Manual you will find information on the following topics:

- Activation conditions
- Storing, maintaining and calling up a speed

- Setting a speed
- Deactivating cruise control

## DISTRONIC PLUS

### General notes

DISTRONIC PLUS regulates the speed and automatically helps you maintain the distance to the vehicle detected in front. Vehicles are detected with the aid of the radar sensor system. DISTRONIC PLUS brakes automatically so that the set speed is not exceeded.

You must select a lower gear in good time on long and steep downhill gradients, especially if the vehicle is laden or towing a trailer. By doing so, you will make use of the braking effect of the engine. This relieves the load on the brake system and prevents the brakes from overheating and wearing too quickly.

If DISTRONIC PLUS detects that there is a risk of a collision, you will be warned visually and acoustically. DISTRONIC PLUS cannot prevent a collision without your intervention. An intermittent warning tone will then sound and the distance warning lamp will light up in the instrument cluster. Brake immediately in order to increase the distance to the vehicle in front or take evasive action provided it is safe to do so.

For DISTRONIC PLUS to assist you when driving, the radar sensor system must be switched on and operational; see "Radar sensor system" in the index.

If there is no vehicle in front, DISTRONIC PLUS operates in the same way as cruise control in the speed range between 20 mph (Canada: 30 km/h) and 120 mph (Canada: 200 km/h). If a vehicle is driving in front of you, it operates in the speed range between 0 mph (0 km/h) and 120 mph (Canada: 200 km/h).

Do not use DISTRONIC PLUS while driving on roads with steep gradients.

As DISTRONIC PLUS transmits radar waves, it can resemble the radar detectors of the responsible authorities. You can refer to the relevant section in the Operator's Manual if questions are asked about this.

#### **i** USA only:

This device has been approved by the FCC as a "Vehicular Radar System". The radar sensor is intended for use in an automotive radar system only. Removing, tampering with, or altering the device will void any warranties, and is not permitted by the FCC. Do not tamper with, alter, or use in any non-approved way.

Any unauthorized modification to this device could void the user's authority to operate the equipment.

#### **i** Canada only: This device complies with RSS-210 of Industry Canada. Operation is subject to the following two conditions:

1. This device may not cause harmful interference, and
2. This device must accept any interference received, including interference that may cause undesired operation of the device.

Removal, tampering, or altering of the device will void any warranties, and is not permitted. Do not tamper with, alter, or use in any non-approved way.

Any unauthorized modification to this device could void the user's authority to operate the equipment.

### Important safety notes

#### **⚠ WARNING**

DISTRONIC PLUS does not react to:

- people or animals
- stationary obstacles on the road, e.g. stopped or parked vehicles
- oncoming and crossing traffic

As a result, DISTRONIC PLUS may neither give warnings nor intervene in such situations. There is a risk of an accident.

Always pay careful attention to the traffic situation and be ready to brake.

 **WARNING**

DISTRONIC PLUS cannot always clearly identify other road users and complex traffic situations.

In such cases, DISTRONIC PLUS may:

- give an unnecessary warning and then brake the vehicle
- neither give a warning nor intervene
- accelerate or brake unexpectedly

There is a risk of an accident.

Continue to drive carefully and be ready to brake, in particular when warned to do so by DISTRONIC PLUS.

 **WARNING**

DISTRONIC PLUS brakes your vehicle with up to 40% of the maximum braking force. If this braking force is insufficient, DISTRONIC PLUS warns you visually and audibly. There is a risk of an accident.

In such cases, apply the brakes yourself and try to take evasive action.

 If DISTRONIC PLUS or the HOLD function is activated, the vehicle brakes automatically in certain situations.

To prevent damage to the vehicle, deactivate DISTRONIC PLUS and the HOLD function in the following or other similar situations:

- when towing the vehicle
- in the car wash

If you fail to adapt your driving style, DISTRONIC PLUS can neither reduce the risk of accident nor override the laws of physics. DISTRONIC PLUS cannot take into account the road, traffic and weather conditions. DISTRONIC PLUS is only an aid. You are responsible for the distance to the vehicle in front, for vehicle speed, for braking in good time and for staying in your lane.

Do not use DISTRONIC PLUS:

- in road and traffic conditions which do not allow you to maintain a constant speed e.g. in heavy traffic or on winding roads
- on slippery road surfaces. Braking or accelerating could cause the drive wheels to lose traction and the vehicle could then skid
- when there is poor visibility, e.g. due to fog, heavy rain or snow

DISTRONIC PLUS may not detect narrow vehicles driving in front, e.g. motorcycles, or vehicles driving on a different line.

In particular, the detection of obstacles can be impaired if:

- there is dirt on the sensors or anything else covering the sensors
- there is snow or heavy rain
- there is interference by other radar sources
- there are strong radar reflections, for example, in parking garages

If DISTRONIC PLUS no longer detects a vehicle in front, DISTRONIC PLUS may unexpectedly accelerate the vehicle to the stored speed.

This speed may:

- be too high if you are driving in a filter lane or an exit lane
- be so high when driving in the right-hand lane that you overtake vehicles in the left-hand lane
- be so high when driving in the left-hand lane that you overtake vehicles in the right-hand lane

If there is a change of drivers, advise the new driver of the speed stored.



### Cruise control lever

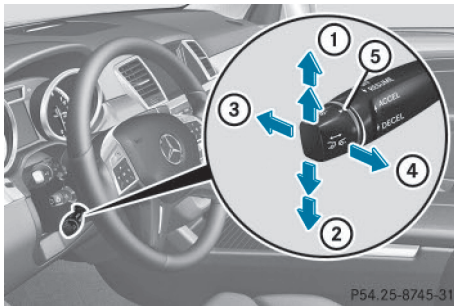

- ① To activate or increase speed
- ② To activate or reduce speed
- ③ To deactivate DISTRONIC PLUS
- ④ To activate at the current speed/last stored speed
- ⑤ To set the specified minimum distance

### Activating DISTRONIC PLUS

#### Activation conditions

In order to activate DISTRONIC PLUS, the following conditions must be fulfilled:

- the engine must be started. It may take up to two minutes after pulling away before DISTRONIC PLUS is operational.
- the electric parking brake must be released.
- ESP® must be active, but not intervening.
- the transmission must be in position **D**.
- the driver's door must be closed when you shift from **P** to **D** or your seat belt must be fastened.
- the front-passenger door and rear doors must be closed.
- off-road program 2 must be deactivated (vehicles with the ON&OFFROAD package).
- DSR must be deactivated.
- the vehicle must not skid.

### Activating

- ▶ Briefly pull the cruise control lever towards you ③, up ① or down ④. DISTRONIC PLUS is selected.
- ▶ **To adjust the set speed in 1 mph increments (1 km/h increments):** briefly press the cruise control lever up ① to the pressure point for a higher speed, or down ④ for a lower speed. Every time the cruise control lever is pressed up or down, the last speed stored is increased or reduced.

or

- ▶ **To adjust the set speed in 5 mph increments (10 km/h increments):** briefly press the cruise control lever up ① past the pressure point for a higher speed, or down ④ for a lower speed. Every time the cruise control lever is pressed up or down, the last speed stored is increased or reduced.

- ▶ Remove your foot from the accelerator pedal.

Your vehicle adapts its speed to that of the vehicle in front, but only up to the desired stored speed.

When driving at speeds below 20 mph (30 km/h), you can only activate DISTRONIC PLUS if the vehicle in front has been detected and is shown in the multifunction display. If the vehicle in front is no longer detected and displayed, for example because it has changed lanes, DISTRONIC PLUS is deactivated. You will hear a warning tone if this is the case.

- ❗ If you do not fully release the accelerator pedal, the **DISTRONIC PLUS Passive** message appears in the multifunction display. The set distance to a slower-moving vehicle in front will then not be maintained. You will be driving at the speed you determine by the position of the accelerator pedal.

### Activating at the current speed/last stored speed

#### WARNING

If you call up the stored speed and it differs from the current speed, the vehicle accelerates or decelerates. If you do not know the stored speed, the vehicle could accelerate or brake unexpectedly. There is a risk of an accident.

Pay attention to the road and traffic conditions before calling up the stored speed. If you do not know the stored speed, store the desired speed again.

- ▶ Briefly pull the cruise control lever towards you ③.
- ▶ Remove your foot from the accelerator pedal.  
DISTRONIC PLUS is operational and when first activated accepts the current speed or adjusts the vehicle's speed to the last speed stored.

### Driving with DISTRONIC PLUS

#### Pulling away and driving

- ▶ **If you want to pull away with DISTRONIC PLUS:** remove your foot from the brake pedal.
- ▶ Briefly pull the cruise control lever towards you ③, up ① or down ④.  
or
- ▶ Accelerate briefly.  
Your vehicle pulls away and adapts its speed to that of the vehicle in front.

If there is no vehicle in front, DISTRONIC PLUS operates in the same way as cruise control.

If DISTRONIC PLUS detects that the vehicle in front has slowed down, it brakes your vehicle. In this way, the distance you have selected is maintained.

If DISTRONIC PLUS detects a faster-moving vehicle in front, it increases the driving speed.

However, the vehicle is only accelerated up to the speed you have stored.

If you depress the brake, DISTRONIC PLUS is deactivated unless your vehicle is stationary.

#### Changing lanes

If you change to the passing lane, DISTRONIC PLUS supports you when:

- you are driving faster than 40 mph (60 km/h)
- DISTRONIC PLUS is maintaining the distance to a vehicle in front
- you switch on the appropriate turn signal
- DISTRONIC PLUS does not detect a danger of collision

If these conditions are fulfilled, your vehicle is accelerated. Acceleration will be interrupted if changing lanes takes too long or if the distance between your vehicle and the vehicle in front becomes too small.

-  When you change lanes, DISTRONIC PLUS monitors the left lane on left-hand-drive vehicles or the right lane on right-hand-drive vehicles.

#### Stopping

#### WARNING

When leaving the vehicle, even if it is braked only by DISTRONIC PLUS, it could roll away if:

- there is a malfunction in the system or in the voltage supply.
- DISTRONIC PLUS has been deactivated with the cruise control lever, e.g. by a vehicle occupant or from outside the vehicle.
- the electrical system in the engine compartment, the battery or the fuses have been tampered with.
- the battery is disconnected.
- the accelerator pedal has been depressed, e.g. by a vehicle occupant.

There is a risk of an accident.

If you wish to exit the vehicle, always turn off DISTRONIC PLUS and secure the vehicle against rolling away.

If DISTRONIC PLUS detects that the vehicle in front is stopping, it brakes your vehicle until it is stationary.

Once your vehicle is stationary, it remains stationary and you do not need to depress the brake.

After a time, the electric parking brake secures the vehicle and relieves the service brake.

Depending on the specified minimum distance, your vehicle will come to a standstill at a sufficient distance behind the vehicle in front. The specified minimum distance is set using the control on the cruise control lever.

The electric parking brake automatically secures the vehicle if DISTRONIC PLUS is activated and:

- the driver's door is open and the driver's seat belt is unfastened.
- the engine is switched off, unless it is automatically switched off by the ECO start/stop function.
- a system malfunction occurs.
- the power supply is not sufficient.

On steep uphill or downhill inclines or if there is a malfunction, the transmission may also automatically be shifted into position **P**.

### Information in the Digital Operator's Manual

In the Digital Operator's Manual you will find information on the following topics:

- Setting a speed
- Setting the specified minimum distance
- DISTRONIC PLUS displays in the instrument cluster

### Deactivating DISTRONIC PLUS

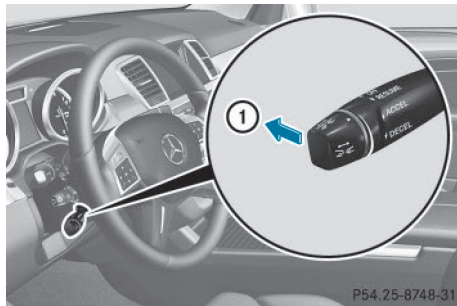

There are several ways to deactivate DISTRONIC PLUS:

- ▶ Briefly press the cruise control lever forwards ①.

or

- ▶ Brake, unless the vehicle is stationary

When you deactivate DISTRONIC PLUS, you will see the **DISTRONIC PLUS Off** message in the multifunction display for approximately five seconds.

**i** The last speed stored remains stored until you switch off the engine.

**i** DISTRONIC PLUS is not deactivated if you depress the accelerator pedal. If you accelerate to overtake, DISTRONIC PLUS adjusts the vehicle's speed to the last speed stored after you have finished overtaking.

DISTRONIC PLUS is automatically deactivated if:

- you engage the electric parking brake or if the vehicle is automatically secured with the electric parking brake
- you are driving slower than 15 mph (25 km/h) and there is no vehicle in front, or if the vehicle in front is no longer detected
- ESP® intervenes or you deactivate ESP®
- the transmission is in the **P**, **R** or **N** position
- you pull the cruise control lever towards you in order to pull away and the front-

passenger door or one of the rear doors is open

- you activate DSR
- you activate off-road program 2 on vehicles with the ON&OFFROAD package
- the vehicle has skidded

If DISTRONIC PLUS is deactivated, you will hear a warning tone. You will see the **DISTRONIC PLUS Off** message in the multi-function display for approximately five seconds.

### Tips for driving with DISTRONIC PLUS

#### General notes

Pay particular attention in the following traffic situations:

- cornering, going into and coming out of a bend
- vehicles traveling on a different line
- other vehicles changing lanes
- narrow vehicles
- obstructions and stationary vehicles
- crossing vehicles

In such situations, brake if necessary. DISTRONIC PLUS is then deactivated.

#### Cornering, going into and coming out of a bend

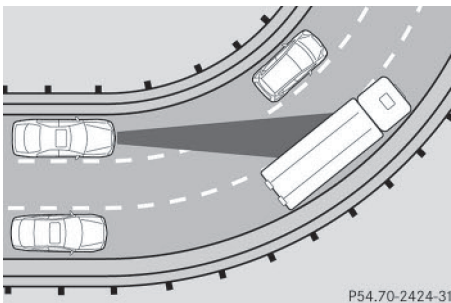

P54.70-2424-31

The ability of DISTRONIC PLUS to detect vehicles when cornering is limited. Your vehicle may brake unexpectedly or late.

#### Vehicles traveling on a different line

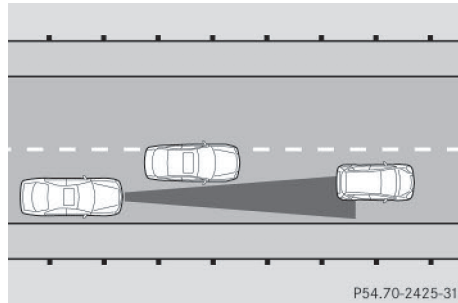

P54.70-2425-31

DISTRONIC PLUS may not detect vehicles traveling on a different line. The distance to the vehicle in front will be too short.

#### Other vehicles changing lanes

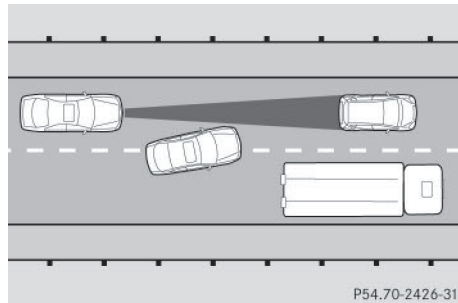

P54.70-2426-31

DISTRONIC PLUS has not detected the vehicle cutting in yet. The distance to this vehicle will be too short.

#### Narrow vehicles

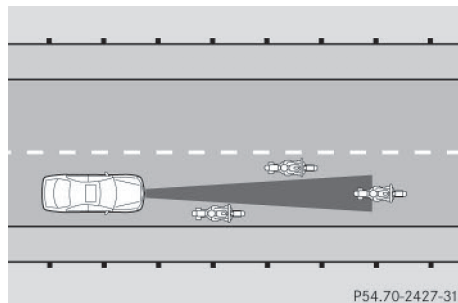

P54.70-2427-31

DISTRONIC PLUS has not yet detected the vehicle in front on the edge of the road,

because of its narrow width. The distance to the vehicle in front will be too short.

### Obstructions and stationary vehicles

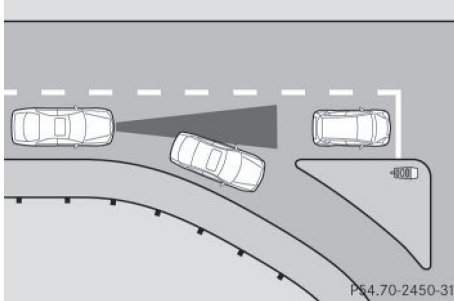

DISTRONIC PLUS does not brake for obstacles or stationary vehicles. If, for example, the detected vehicle turns a corner and reveals an obstacle or stationary vehicle, DISTRONIC PLUS will not brake for these.

### Crossing vehicles

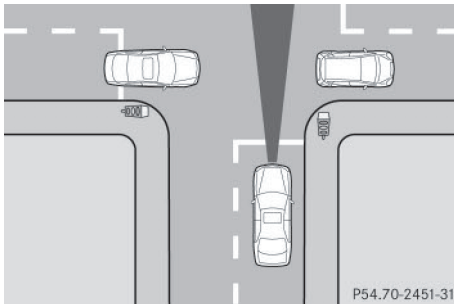

DISTRONIC PLUS may mistakenly detect vehicles that are crossing your lane. Activating DISTRONIC PLUS at traffic lights with crossing traffic, for example, could cause your vehicle to pull away unintentionally.

### Level control (vehicles with the ON&OFFROAD package)

#### Important safety notes

Level control adapts the vehicle level automatically to the current operating and driving situation. This results in reduced fuel consumption and improved handling.

Make changes to the vehicle level while the vehicle is in motion. This enables the vehicle to adjust to the new level as quickly as possible.

The vehicle level may change visibly if you park the vehicle and the outside temperature changes. If the temperature drops, the vehicle level is lower; with an increase in temperature, the vehicle level rises.

If you unlock the vehicle or open a door, the vehicle begins to compensate for load discrepancies while still parked. However, for significant level changes, such as after the vehicle has been stationary for a long period, the engine must be on. For safety reasons, the vehicle is only lowered when the doors are closed. Lowering is interrupted if a door is opened, and it continues once the door has been closed.

For information about driving off-road, see (▷ page 152).

#### **WARNING**

When the vehicle is being lowered, people could become trapped if their limbs are between the vehicle body and the wheels or underneath the vehicle. There is a risk of injury.

Make sure no one is underneath the vehicle or in the immediate vicinity of the wheel arches when the vehicle is being lowered.

#### **WARNING**

When you drive with the vehicle raised, the driving characteristics could be impaired by the vehicle's raised center of gravity. The vehicle could rollover more easily, for example on a bend. There is a risk of an accident.

Always select as low a vehicle level as possible and adjust your driving style.

#### **WARNING**

When you drive with the chassis lowered or raised, the vehicle's braking and driving characteristics can be significantly impaired. You could also exceed the permissible vehicle

height if the chassis is raised. There is a risk of an accident.

Adjust the vehicle level before pulling away.

### WARNING

Due to the high center of gravity, the vehicle may start to skid and roll over in the event of an abrupt steering maneuver and/or when the vehicle's speed is not adapted to the road conditions. There is a risk of an accident.

Always adapt your speed and driving style to the vehicle's driving characteristics and to the prevailing road and weather conditions.

**!** When driving on extremely rough terrain, select a high vehicle level in good time. Make sure there is always sufficient ground clearance. You will otherwise damage the vehicle.

- Utility vehicles have a significantly higher rollover rate than other types of vehicles. Failure to operate this vehicle safely may result in an accident, rollover of the vehicle, and severe or fatal injury.
- In a rollover crash, an unbelted person is significantly more likely to die than a person wearing a seat belt. You and all vehicle occupants should always wear your seat belts.

### Basic settings

The extent to which the vehicle is raised or lowered depends on the basic setting selected.

Select:

- highway/high-speed level for driving on normal roads
- off-road level 1 for driving on easily negotiable off-road terrain
- off-road level 2 for driving on normal off-road terrain
- off-road level 3 for freeing the vehicle in particularly rough terrain at low speeds only

The individual vehicle levels differ from highway level as follows:

- highway level: +/-0 in (+/-0 mm)
- high-speed level: -0.6 in (-15 mm)
- off-road level 1: + 1.2 in (+ 30 mm)
- off-road level 2: + 2.3 in (+ 60 mm)
- off-road level 3: + 3.6 in (+ 90 mm)

### Overview

**!** Make sure that there is enough ground clearance when the vehicle is being lowered. It could otherwise hit the ground, damaging the underbody.

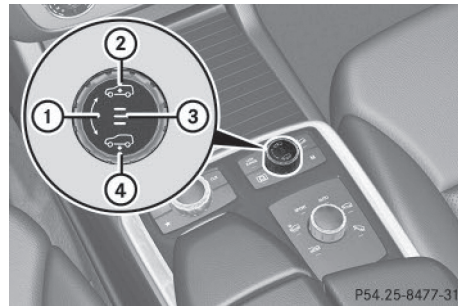

- ① Selector wheel
- ② To raise the level
- ③ Indicator lamps
- ④ To lower the level

### Information in the Digital Operator's Manual

In the Digital Operator's Manual you can find information on the following subjects:

- Highway/high-speed level
- Off-road levels



## HOLD function

### General notes

The HOLD function can assist the driver in the following situations:

- when pulling away, especially on steep slopes
- when maneuvering on steep slopes
- when waiting in traffic

The vehicle is kept stationary without the driver having to depress the brake pedal.

The braking effect is canceled and the HOLD function deactivated when you depress the accelerator pedal to pull away.

- ❗ Do not use the HOLD function when driving off-road, on steep uphill or downhill gradients or on slippery or loose surfaces. The HOLD function cannot hold the vehicle on such surfaces.

### Important safety notes

#### ⚠ WARNING

When leaving the vehicle, it can still roll away despite being braked by the HOLD function if:

- there is a malfunction in the system or in the voltage supply.
- the HOLD function has been deactivated by pressing the accelerator pedal or the brake pedal, e.g. by a vehicle occupant.
- the electrical system in the engine compartment, the battery or the fuses have been tampered with.
- the battery is disconnected

There is a risk of an accident.

If you wish to exit the vehicle, always turn off the HOLD function and secure the vehicle against rolling away.

- ❗ If DISTRONIC PLUS or the HOLD function is activated, the vehicle brakes automatically in certain situations.

To prevent damage to the vehicle, deactivate DISTRONIC PLUS and the HOLD function in the following or other similar situations:

- when towing the vehicle
- in the car wash

Deactivate the HOLD function (▷ page 165).

### Activation conditions

You can activate the HOLD function if:

- the vehicle is stationary
- the engine is running or if it has been automatically switched off by the ECO start/stop function
- the driver's door is closed or your seat belt is fastened
- the electric parking brake is released
- the transmission is in position **D**, **R** or **N**
- DISTRONIC PLUS is deactivated

### Activating the HOLD function

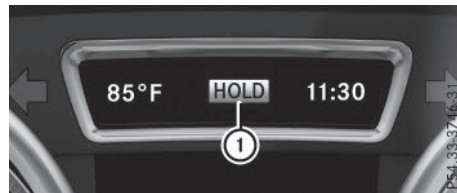

- ▶ Make sure that the activation conditions are met.
- ▶ Depress the brake pedal.
- ▶ Quickly depress the brake pedal further until ① appears in the multifunction display. The HOLD function is activated. You can release the brake pedal.

- ❗ If depressing the brake pedal the first time does not activate the HOLD function, wait briefly and then try again.



## Deactivating the HOLD function

The HOLD function is deactivated automatically if:

- you accelerate and the transmission is in position **D** or **R**.
- you shift the transmission to position **P**.
- you depress the brake pedal again with a certain amount of pressure until ① disappears from the multifunction display.
- you secure the vehicle using the electric parking brake.
- you activate DISTRONIC PLUS.

- ① After a time, the electric parking brake secures the vehicle and relieves the service brake.

The electric parking brake secures the vehicle automatically if the HOLD function is activated when the vehicle is stationary and:

- the driver's door is open and the driver's seat belt is unfastened.
- the engine is switched off, unless it is automatically switched off by the ECO start/stop function.
- a system malfunction occurs.
- the power supply is not sufficient.

On steep uphill or downhill inclines or if there is a malfunction, the transmission may also be automatically shifted into position **P**.

## AIRMATIC package

### General notes

AIRMATIC regulates the level of your vehicle. As well as level control (▷ page 165), your vehicle can be equipped with ADS (Adaptive Damping System) (▷ page 165) and ACTIVE CURVE SYSTEM (▷ page 165).

Observe the notes on driving with a trailer (▷ page 191).

## ADS (Adaptive Damping System)

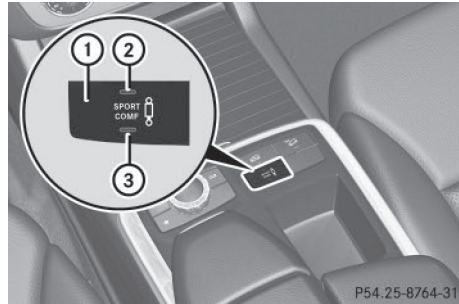

Example: vehicles without the ON&OFFROAD package

- ① Suspension tuning button
- ② Indicator lamp for sports tuning
- ③ Indicator lamp for comfort tuning

## Active Curve System

The Active Curve System uses active stabilizers to optimize both driving comfort and vehicle agility. Depending on the ADS mode selected (▷ page 165), the Active Curve System also changes the setting.

If you select ADS comfort mode:

- rolling movement is reduced in the event of changing surface undulations
- the roll angle when cornering is reduced
- the driving style is agile

If you select ADS sport mode:

- the roll angle is reduced significantly
- the driving style is even more agile

## Level control

### Important safety notes

#### ⚠ WARNING

When the vehicle is being lowered, people could become trapped if their limbs are between the vehicle body and the wheels or underneath the vehicle. There is a risk of injury.

Make sure no one is underneath the vehicle or in the immediate vicinity of the wheel arches when the vehicle is being lowered.

 **WARNING**

When you drive with the vehicle raised, the driving characteristics could be impaired by the vehicle's raised center of gravity. The vehicle could rollover more easily, for example on a bend. There is a risk of an accident.

Always select as low a vehicle level as possible and adjust your driving style.

 **WARNING**

When you drive with the chassis lowered or raised, the vehicle's braking and driving characteristics can be significantly impaired. You could also exceed the permissible vehicle height if the chassis is raised. There is a risk of an accident.

Adjust the vehicle level before pulling away.

 **WARNING**

Due to the high center of gravity, the vehicle may start to skid and roll over in the event of an abrupt steering maneuver and/or when the vehicle's speed is not adapted to the road conditions. There is a risk of an accident.

Always adapt your speed and driving style to the vehicle's driving characteristics and to the prevailing road and weather conditions.

 When driving on extremely rough terrain, select a high vehicle level in good time.

Make sure there is always sufficient ground clearance. You will otherwise damage the vehicle.

 When you raise the vehicle in such a way that not all wheels have contact with the ground, remove the SmartKey from the ignition lock.

 Make sure that there is enough ground clearance when the vehicle is being lowered. It could otherwise hit the ground, damaging the underbody.

- Utility vehicles have a significantly higher rollover rate than other types of vehicles. Failure to operate this vehicle safely may result in an accident, rollover of the vehicle, and severe or fatal injury.

- In a rollover crash, an unbelted person is significantly more likely to die than a person wearing a seat belt.

You and all vehicle occupants should always wear your seat belts.

### General notes

Further information about "Driving off-road" ([▷ page 152](#)).

Level control adapts the vehicle level automatically to the current operating and driving situation. This results in reduced fuel consumption and improved handling.

If you select ADS comfort mode ([▷ page 165](#)), the vehicle is lowered to high-speed level as the speed increases. As the vehicle speed decreases, the vehicle is raised back up to highway level.

If you select ADS sport mode ([▷ page 165](#)), the vehicle skips highway level and lowers directly to high-speed level depending on the basic setting ([▷ page 167](#)).

Make changes to the vehicle level while the vehicle is in motion. This enables the vehicle to adjust to the new level as quickly as possible.

The vehicle level may change visibly if you park the vehicle and the outside temperature changes. If the temperature drops, the vehicle level is lower; with an increase in temperature, the vehicle level rises.

If you unlock the vehicle or open a door, the vehicle begins to compensate for load discrepancies while still parked. However, for significant level changes, such as after the vehicle has been stationary for a long period, the engine must be on. For safety reasons, the vehicle is only lowered when the doors are closed. Lowering is interrupted if a door is opened, and it continues once the door has been closed.

### Basic settings (excluding Mercedes-AMG vehicles)

The extent to which the vehicle is raised or lowered depends on the basic setting selected. Select raised level for off-road driving or highway/high-speed level for normal roads.

The individual vehicle levels differ from highway level as follows:

- highway level: +/-0 in (+/-0 mm)
- high-speed level: -0.6 in (-15 mm)
- raised level: +2.3 in (+60 mm)

### Basic settings Mercedes-AMG vehicles

The extent to which the vehicle is raised or lowered depends on the AMG adaptive sport suspension setting selected. Select the raised level for off-road driving or highway/high-speed level for normal roads.

The raised level corresponds to a vehicle level raised by 50 mm when compared with highway level in comfort mode.

### Raised level

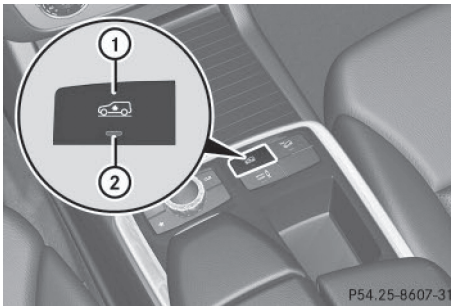

- ① Level control button
- ② Level control indicator lamp

Only select raised level if this is appropriate for the road conditions. Otherwise, fuel consumption may increase and handling may be affected.

### Highway/high-speed level

**!** Make sure that there is enough ground clearance when the vehicle is being lowered. It could otherwise hit the ground, damaging the underbody.

The vehicle automatically adjusts to highway level when you:

- drive faster than 50 mph (80 km/h)
- drive between 40 mph (64 km/h) and 50 mph (80 km/h) for approximately 20 seconds

Depending on the ADS mode selected (> page 165), the vehicle is lowered to high-speed level at high speeds.

### AMG adaptive sport suspension system

#### Information in the Digital Operator's Manual

In the Digital Operator's Manual you will find information on the following topics:

- Vehicle level
- Suspension tuning

### Important safety notes

#### **⚠ WARNING**

When the vehicle is being lowered, people could become trapped if their limbs are between the vehicle body and the wheels or underneath the vehicle. There is a risk of injury.

Make sure no one is underneath the vehicle or in the immediate vicinity of the wheel arches when the vehicle is being lowered.

#### **⚠ WARNING**

The vehicle is lowered if:

- you have selected the Comfort or Sport suspension tuning and
- lock the vehicle after switching off the engine

Persons in the vicinity of the wheel arch or the underbody may thus become trapped. There is a risk of injury.

Make sure that nobody is in the vicinity of the wheel arch or the underbody when you switch off the engine.

P54.25-8607-31

**!** The vehicle is lowered by approximately 10 mm if:

- you have selected the Sport or Comfort suspension tuning and
- you switch off the engine and then
- lock the vehicle

When parking, position your vehicle so that it does not make contact with the curb as the vehicle is lowered. Your vehicle could otherwise be damaged.

## PARKTRONIC

### Important safety notes

PARKTRONIC is an electronic parking aid with ultrasonic sensors. It monitors the area around your vehicle using six sensors in the front bumper and four sensors in the rear bumper. PARKTRONIC indicates visually and audibly the distance between your vehicle and an object.

PARKTRONIC is only an aid. It is not a replacement for your attention to your immediate surroundings. You are always responsible for safe maneuvering, parking and exiting a parking space. When maneuvering, parking or pulling out of a parking space, make sure that there are no persons, animals or objects in the area in which you are maneuvering.

**!** When parking, pay particular attention to objects above or below the sensors, such as flower pots or trailer drawbars. PARKTRONIC does not detect such objects when they are in the immediate vicinity of the vehicle. You could damage the vehicle or the objects.

The sensors may not detect snow and other objects that absorb ultrasonic waves.

Ultrasonic sources such as an automatic car wash, the compressed-air brakes on a truck or a pneumatic drill could cause PARKTRONIC to malfunction.

PARKTRONIC may not function correctly on uneven terrain.

PARKTRONIC is activated automatically when you:

- switch on the ignition
- shift the transmission to position **D**, **R** or **N**
- release the electric parking brake

PARKTRONIC is deactivated at speeds above 11 mph (18 km/h). It is reactivated at lower speeds.

### Range of the sensors

#### General notes

PARKTRONIC does not take objects into consideration that are:

- below the detection range, e.g. people, animals or objects.
- above the detection range, e.g. overhanging loads, truck overhangs or loading ramps.

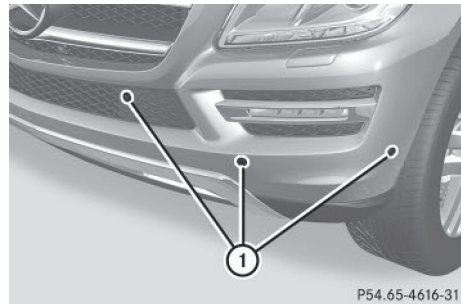

① Sensors in the front bumper, left-hand side (example)

The sensors must be free from dirt, ice or slush. They can otherwise not function correctly. Clean the sensors regularly, taking care not to scratch or damage them (> page 272).

## Range

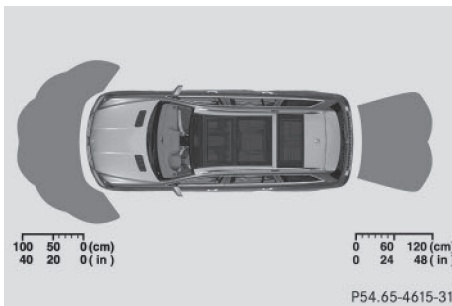
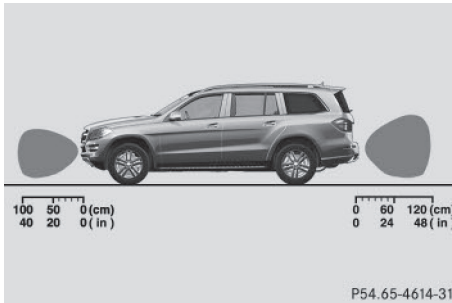

### Front sensors

Center	Approx. 40 in (approx. 100 cm)
Corners	Approx. 24 in (approx. 60 cm)

### Rear sensors

Center	Approx. 48 in (approx. 120 cm)
Corners	Approx. 32 in (approx. 80 cm)

### Minimum distance

Center	Approx. 8 in (approx. 20 cm)
Corners	Approx. 6 in (approx. 15 cm)

If there is an obstacle within this range, the relevant warning displays light up and a warn-

ing tone sounds. If the distance falls below the minimum, the distance may no longer be shown.

## Information in the Digital Operator's Manual

In the Digital Operator's Manual you will find information on the following topics:

- Warning displays
- Deactivating/activating PARKTRONIC
- Towing a trailer
- Problems with PARKTRONIC

## Active Parking Assist

### General notes

Active Parking Assist is an electronic parking aid with ultrasound. It measures the road on both sides of the vehicle. A parking symbol indicates a suitable parking space. Active steering intervention can assist you during parking. You may also use PARKTRONIC (> page 168).

### Important safety notes

Active Parking Assist is merely an aid. It is not a replacement for your attention to your immediate surroundings. You are always responsible for safe maneuvering, parking and exiting a parking space. Make sure that no persons, animals or objects are in the maneuvering range.

When PARKTRONIC is switched off, Active Parking Assist is also unavailable.

### WARNING

If there are objects above the detection range, Active Parking Assist may turn prematurely. You may cause a collision as a result. There is a risk of an accident.

If there are objects above the detection range, stop and deactivate Active Parking Assist.

**⚠ WARNING**

Active Parking Assist merely aids you by intervening actively in the steering. If you do not brake there is a risk of an accident.

Always apply the brakes yourself when maneuvering and parking.

**⚠ WARNING**

While parking or pulling out of a parking space, the vehicle swings out and can drive onto areas of the oncoming lane. This could result in a collision with another road user. There is a risk of an accident.

Pay attention to other road users. Stop the vehicle if necessary or cancel the Active Parking Assist parking procedure.

- !** If unavoidable, you should drive over obstacles such as curbs slowly and not at a sharp angle. Otherwise, you may damage the wheels or tires.

Active Parking Assist may possibly indicate parking spaces which are not suitable for parking, for example:

- where parking or stopping is prohibited
- in front of driveways or entrances and exits
- on unsuitable surfaces

Parking tips:

- On narrow roads, drive as close to the parking space as possible.
- Parking spaces that are littered or overgrown might be identified or measured incorrectly.
- Parking spaces that are partially occupied by trailer drawbars might not be identified as such or be measured incorrectly.
- Snowfall or heavy rain may lead to a parking space being measured inaccurately.
- Pay attention to the PARKTRONIC (> page 169) warning messages during the parking procedure.
- At any time, you can intervene in the steering procedure to correct it. Active Parking Assist will then be canceled.

- When transporting a load which protrudes from your vehicle, you should not use Active Parking Assist.
- Never use Active Parking Assist when snow chains are installed.
- Make sure that the tire pressures are always correct. This has a direct influence on the parking characteristics of the vehicle.

Use Active Parking Assist for parking spaces:

- that are parallel to the direction of travel
- that are on straight roads, not bends
- that are on the same level as the road, e.g. not on the pavement

### Information in the Digital Operator's Manual

In the Digital Operator's Manual you will find information on the following topics:

- Detecting parking spaces
- Parking
- Exiting a parking space
- Canceling Active Parking Assist
- Towing a trailer

### Rear view camera

#### General notes

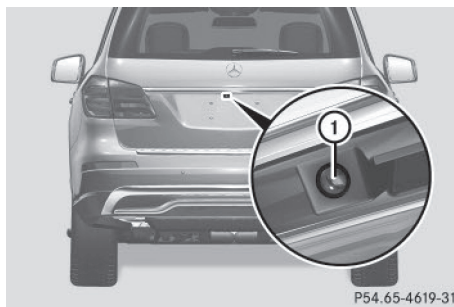

Rear view camera ① is in the handle on the tailgate.

Rear view camera ① is an optical parking and maneuvering aid. It shows the area behind



your vehicle with guide lines in the COMAND display.

The area behind the vehicle is displayed as a mirror image, as in the rear view mirror.

- i** The text of messages shown in the COMAND display depends on the language setting. The following are examples of rear view camera messages in the COMAND display.

### Important safety notes

The rear view camera is only an aid. It is not a replacement for your attention to your immediate surroundings. You are always responsible for safe maneuvering and parking. When maneuvering or parking, make sure that there are no persons, animals or objects in the area in which you are maneuvering.

Under the following circumstances, the rear view camera will not function, or will function in a limited manner:

- if the tailgate is open
- in heavy rain, snow or fog
- at night or in very dark places
- if the camera is exposed to very bright light
- if the area is lit by fluorescent bulbs or LED lighting (the display may flicker)
- if there is a sudden change in temperature, e.g. when driving into a heated garage in winter
- if the camera lens is dirty or obstructed. Observe the notes on cleaning (> page 272)
- if the rear of your vehicle is damaged. In this event, have the camera position and setting checked at a qualified specialist workshop

The field of vision and other functions of the rear view camera may be restricted due to additional accessories on the rear of the vehicle (e.g. license plate holder, bicycle rack).

For technical reasons, leaving the standard height can result in inaccuracies in the guide lines on vehicles with a height-adjustable chassis.

**!** Objects not at ground level may appear to be further away than they actually are, e.g.:

- the bumper of a parked vehicle
- the drawbar of a trailer
- the ball coupling of a trailer tow hitch
- the rear section of an HGV
- a slanted post

Use the guidelines only for orientation.

Approach objects no further than the bottom-most guideline.

The rear view camera may show a distorted view of obstacles, show them incorrectly or not at all. The rear view camera does not show objects in the following positions:

- very close to the rear bumper
- under the rear bumper
- in the area immediately above the tailgate handle

### Activating/deactivating the rear view camera

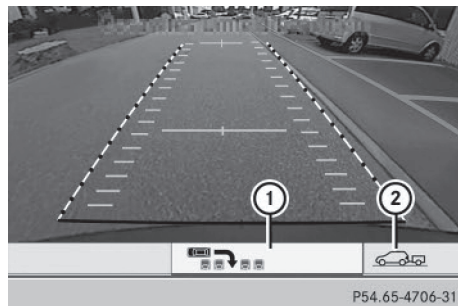

► **To activate:** make sure that the SmartKey is in position **2** in the ignition lock.

► Make sure that the "Show rear view camera display" function is selected in COMAND (see the Digital Operator's Manual).

► Engage reverse gear.

The area behind the vehicle is shown in the COMAND display with guide lines.

► **To change the function mode for vehicles with trailer tow hitch:** using the COMAND controller, select symbol **1** for the "Reverse parking" function or sym-



bol ② for "Coupling up a trailer" (see the separate COMAND operating instructions). The symbol of the selected function is highlighted.

**To deactivate:** the rear view camera deactivates if you shift the transmission to **P** or after driving forwards a short distance.

### Information in the Digital Operator's Manual

In the Digital Operator's Manual you will find information on the following topics:

- Displays in the COMAND display
- "Reverse parking" function
- "Coupling up a trailer" function

### 360° camera (surround view)

#### General notes

The 360° camera is a system consisting of four cameras.

The system analyzes images from the following cameras:

- Rear view camera
- Front camera
- Two cameras in the exterior rear view mirrors

The cameras capture the immediate surroundings of the vehicle. The system supports you, e.g. when parking or if vision is restricted at an exit.

The 360° camera images can be shown in full screen mode or in seven different split-screen views on the COMAND display. A split-screen view also includes a top view of the vehicle. This view is calculated from the data supplied by the installed cameras (virtual camera).

The seven split-screen views are:

- top view and picture from the rear view camera (130° viewing angle)
- top view and picture from the front camera (without displaying the maximum steering wheel angle)

- top view and enlarged rear view
- top view and enlarged front view
- top view and trailer view (vehicles with trailer tow hitch)
- top view and rear-view images from the exterior mirror cameras (rear wheel view)
- top view and forward-view images from the exterior mirror cameras (front wheel view)

**i** The top view and trailer view are available for vehicles equipped with a trailer tow hitch.

When the function is active and you shift the transmission from position **D** or **R** to **N**, you see the previous view in the COMAND display. The dynamic guidelines are hidden.

When you change between transmission positions **D** and **R**, you see the previously selected front or rear view.

#### Important safety notes

The 360° camera is only an aid. It is not a replacement for your attention to your immediate surroundings. You are always responsible for safe maneuvering and parking. When maneuvering or parking, make sure that there are no persons, animals or objects in the area in which you are maneuvering.

The 360° camera may show a distorted view of obstacles, show them incorrectly or not at all. It cannot show objects in the following areas:

- under the front bumper
- very close to the front bumper
- very close to the rear bumper
- under the rear bumper
- in close range above the handle on the trunk lid
- very close to the exterior mirrors

You are always responsible for safety, and must always pay attention to your surroundings when parking and maneuvering. This applies to the areas behind, in front of and beside the vehicle. You could otherwise endanger yourself and others.

The 360° camera will not function or will function in a limited manner:

- if the doors are open
- if the exterior mirrors are folded in
- if the tailgate is open
- in heavy rain, snow or fog
- at night or in very dark places
- if the cameras are exposed to very bright light
- if the area is lit by fluorescent bulbs or LED lighting (the display may flicker)
- if there is a sudden change in temperature, e.g. when driving into a heated garage in winter
- if the camera lenses are dirty or covered
- if the vehicle components in which the cameras are installed are damaged. In this event, have the camera position and setting checked at a qualified specialist workshop.

Do not use the 360° camera in this case. You can otherwise injure others or cause damage to objects or the vehicle.

### Activation conditions

The 360° camera image can be displayed if:

- your vehicle is equipped with a 360° camera
- COMAND is switched on, see the separate COMAND operating instructions
- the **360° Camera** function is activated

### Activating the 360° camera using the SYS button

- ▶ Press and hold the **sys** button for longer than 2 seconds, see the separate COMAND operating instructions.

Depending on whether position **D** or **R** is engaged, the following is shown:

- full screen display with the image from the front camera
- full screen display with the image from the rear view camera

### Activating the 360° camera with COMAND

- ▶ Press the **sys** button, see the separate COMAND operating instructions.
- ▶ Select **System** by turning **⏻** the COMAND controller and press **⏻** to confirm.
- ▶ Select **360° Camera** and press **⏻** to confirm.

Depending on whether position **D** or **R** is engaged, the following is shown:

- a split screen with top view and the image from the front camera or
- a split screen with top view and the image from the rear view camera

For further information about the COMAND controller, see the separate COMAND operating instructions.

### Activating the 360° camera using reverse gear

The 360° camera images can be automatically displayed by engaging reverse gear.

- ▶ Make sure that the SmartKey is in position **2** in the ignition lock.
- ▶ Make sure that the **Activation by R gear** function is selected in COMAND, see the separate COMAND operating instructions.
- ▶ **To show the 360° camera image:** engage reverse gear.

The COMAND display shows the area behind the vehicle in split screen:



- vehicle with guide lines
- top view of the vehicle

### Information in the Digital Operator's Manual

In the Digital Operator's Manual you will find information on the following topics:

- Displays in the COMAND display
- Display with the PARKTRONIC display

### Exiting 360° camera display mode

As soon as your vehicle exceeds a speed of 19 mph (30 km/h) with the function activated, the function switches off. The COMAND display switches back to the previously selected view. You can also switch the display by selecting the  symbol in the display and pressing  the COMAND controller to confirm.

## ATTENTION ASSIST

### General notes

ATTENTION ASSIST helps you during long, monotonous journeys, such as on highways. It is active in the range between 50 mph (80 km/h) and 112 mph (180 km/h). If ATTENTION ASSIST detects typical indicators of fatigue or increasing lapses in concentration on the part of the driver, it suggests you take a break.

### Important safety notes

ATTENTION ASSIST is only an aid to the driver. It might not always recognize fatigue or increasing inattentiveness in time or fail to recognize them at all. The system is not a substitute for a well-rested and attentive driver.

The functionality of ATTENTION ASSIST is restricted and warnings may be delayed or not occur at all:

- if the road condition is poor, e.g. if the surface is uneven or if there are potholes
- if there is a strong side wind
- if you have adopted a sporty driving style with high cornering speeds or high rates of acceleration
- if you are predominantly driving slower than 50 mph (80 km/h) or faster than 112 mph (180 km/h)
- if the time has been set incorrectly
- in active driving situations, such as when you change lanes or change your speed

ATTENTION ASSIST is reset when you continue your journey and starts assessing your tiredness again if:

- you switch off the engine
- you take off your seat belt and open the driver's door, e.g. for a change of drivers or to take a break

### Activating ATTENTION ASSIST

- ▶ Activate ATTENTION ASSIST using the on-board computer (▷ page 199).

When ATTENTION ASSIST is deactivated, the  symbol appears in the multifunction display in the assistance graphic display.

ATTENTION ASSIST is activated automatically after the engine is started up.

### Warning and display messages in the multifunction display

You can find information about this in the Digital Operator's Manual.

## Night View Assist Plus

### General notes

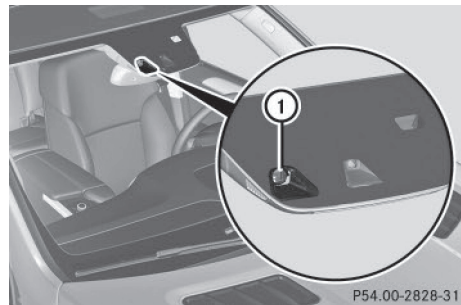

In addition to the illumination provided by the normal headlamps, Night View Assist Plus uses infrared light to illuminate the road. Night View Assist Plus camera ① picks up the infrared light and displays a monochrome image in COMAND. The image displayed in COMAND corresponds to a road lit up by high-beam headlamps. This enables you to see the

road's course and any obstacles in good time. If pedestrian recognition is activated, pedestrians recognized by the system are highlighted in the Night View Assist Plus display.

Light from the headlamps of oncoming vehicles does not affect the Night View Assist Plus display in the multifunction display. This is also the case if you cannot switch on the high-beam headlamps due to oncoming traffic.

- i** Infrared light is not visible to the human eye and therefore does not glare. Night View Assist Plus can therefore remain switched on even if there is oncoming traffic.

### Important safety notes

Night View Assist Plus is only an aid and is not a substitute for attentive driving. Do not rely on the Night View Assist Plus display. You are responsible for the distance to the vehicle in front, for vehicle speed and for braking in good time. Drive carefully and always adapt your driving style to suit the prevailing road and traffic conditions.

The system may be impaired or may not function if:

- there is poor visibility, e.g. due to snow, rain, fog or spray
- the windshield is dirty, fogged up or covered, for instance by a sticker, in the vicinity of the camera
- on bends, on uphill gradients or downhill gradients

Pedestrian recognition may be impaired or inoperative if:

- pedestrians are partially or entirely obscured by objects, e.g. parked vehicles
- the silhouette of the pedestrian in the Night View Assist Plus display is incomplete or interrupted, e.g. by powerful light reflections

- pedestrians do not contrast adequately from the background
- pedestrians are not in an upright position, e.g. sitting, squatting or lying

### Activating Night View Assist Plus

#### Activation conditions

You can only activate Night View Assist Plus if:

- the SmartKey is in position **2** in the ignition lock.
- it is dark.
- the light switch is in the **AUTO** or  position.
- reverse gear has not been engaged.

#### Activating Night View Assist Plus

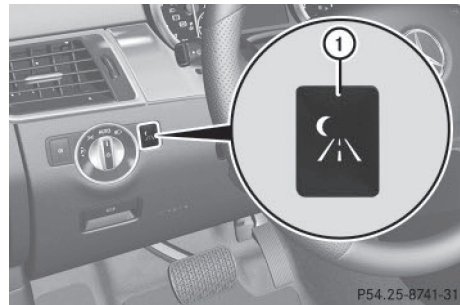

- ▶ Make sure that COMAND is switched on.
- ▶ Press button **1**.  
The Night View Assist Plus display appears in the COMAND display.

You can read about how to adjust the brightness of the COMAND display in the COMAND operating instructions.

- i** The infrared headlamps only switch on when the vehicle is being driven at speeds of approximately 6 mph (10 km/h). This means that you do not have the full visual range while the vehicle is stationary and cannot check whether Night View Assist Plus is working.

### Pedestrian recognition

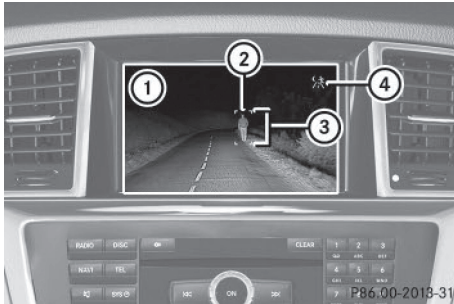

- ① Night View Assist Plus display
  - ② Pedestrian recognized
  - ③ Framing
  - ④ Symbol for active pedestrian recognition
- i** Animals are not recognized by pedestrian recognition.

Night View Assist Plus is able to recognize pedestrians by typical characteristics, e.g. a silhouette in the shape of a person.

Pedestrian recognition is then switched on automatically if:

- Night View Assist Plus is activated.
- you are driving faster than approximately 6 mph (10 km/h).
- the surroundings are dark, e.g. when driving outside built-up areas without street lighting.

If pedestrian recognition is active, symbol ④ appears. If pedestrians are detected, they are highlighted with framing ③. If the pedestrian recognition system has brought a pedestrian to your attention, look through the windshield to evaluate the situation. The actual distance to objects and pedestrians cannot be gaged accurately by looking at a screen.

It may be the case that objects are highlighted as well as pedestrians.

### Fogged up or dirty windshield

If the windshield in front of the camera is fogged up or dirty on the inside or outside, the Night View Assist Plus display is affected.

► **To defrost:** check the automatic air conditioning settings (▷ page 131) and fold down the camera cover (▷ page 272).

► **To defrost the inside of the windshield:** fold down the camera cover (▷ page 272) and clean the windshield (▷ page 272).

## Problems with Night View Assist Plus

Problem	Possible causes/consequences and ► Solutions
The picture quality of Night View Assist Plus has deteriorated.	The windshield wipers are smearing the windshield. ► Replace the wiper blades (▷ page 120).
	The windshield is smeared after the vehicle has been cleaned in a car wash. ► Clean the windshield (▷ page 272).
	There is windshield chip damage in the camera's field of vision. ► Replace the windshield.
	The windshield is fogged up on the inside. ► Defrost the windshield (▷ page 131).
	The windshield is iced up. ► De-ice the windshield (▷ page 131).
	There is dirt on the inside of the windshield. ► Clean the inside of the windshield (▷ page 272).

### Lane Tracking package

#### General notes

The Lane Tracking package consists of Blind Spot Assist (▷ page 177) and Lane Keeping Assist (▷ page 179).

#### Blind Spot Assist

##### General notes

Blind Spot Assist monitors the areas on either side of the vehicle that are not visible to the driver with two lateral, rear-facing radar sensors. A warning display in the exterior mirrors draws your attention to vehicles detected in the monitored area. If you then switch on the corresponding turn signal to change lanes, you will also receive a visual and audible collision warning.

Blind Spot Assist supports you from a speed of approximately 20 mph (30 km/h).

### Important safety notes

#### WARNING

Blind Spot Assist does not react to:

- vehicles overtaken too closely on the side, placing them in the blind spot area
- vehicles which approach with a large speed differential and overtake your vehicle

As a result, Blind Spot Assist may not give warnings in such situations. There is a risk of an accident.

Always observe the traffic conditions carefully, and maintain a safe lateral distance.

Blind Spot Assist is only an aid. It may fail to detect some vehicles and is no substitute for attentive driving. Always ensure that there is sufficient distance to the side for other road users and obstacles.

#### USA only:

This device has been approved by the FCC as a "Vehicular Radar System". The radar sensor is intended for use in an automotive

radar system only. Removing, tampering with, or altering the device will void any warranties, and is not permitted by the FCC. Do not tamper with, alter, or use in any non-approved way.

Any unauthorized modification to this device could void the user's authority to operate the equipment.

### Radar sensors

The radar sensors for Blind Spot Assist are integrated into the rear bumper. Make sure that the bumpers are free from dirt, ice or slush. The sensors must not be covered, for example by cycle racks or overhanging loads. Following a severe impact or in the event of damage to the bumpers, have the function of the radar sensors checked at a qualified specialist workshop. Blind Spot Assist may no longer work properly.

### Monitoring range of the sensors

In particular, the detection of obstacles can be impaired if:

- there is dirt on the sensors or anything else covering the sensors
- there is poor visibility, e.g. due to fog, heavy rain or snow
- narrow vehicles, e.g. motorcycles or bicycles
- the road has very wide lanes
- the road has narrow lanes
- you are not driving in the middle of the lane
- there are barriers or similar lane borders

Vehicles in the monitoring range are then not indicated.

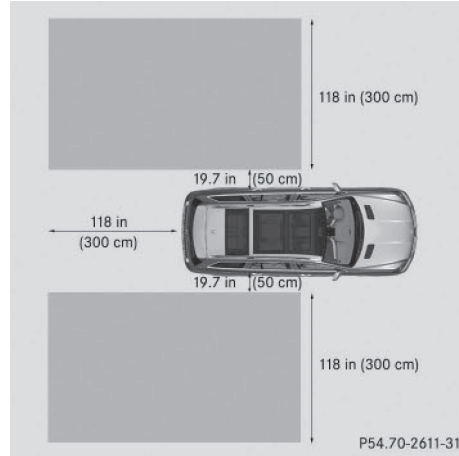

Blind Spot Assist monitors the area up to 10 ft (3 m) behind your vehicle and directly next to your vehicle, as shown in the diagram.

If the lanes are narrow, vehicles driving in the lane beyond the lane next to your vehicle may be indicated, especially if the vehicles are not driving in the middle of their lane. This may be the case if there are vehicles driving at the inner edge of their lanes.

Due to the nature of the system:

- warnings may be issued in error when driving close to crash barriers or similar solid lane borders.
- the warning is canceled when driving for an extended period next to long vehicles, such as trucks.

### Warning display

Blind Spot Assist is not active at speeds below approximately 20 mph (30 km/h). Vehicles in the monitoring range are then not indicated.



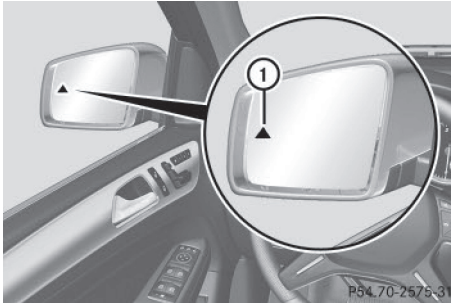

① Yellow indicator lamp/red warning lamp  
When Blind Spot Assist is activated, indicator lamp ① in the exterior mirrors lights up yellow at speeds of up to 20 mph (30 km/h). At speeds above 20 mph (30 km/h), the indicator lamp goes out and Blind Spot Assist is operational.

If a vehicle is detected within the blind spot monitoring range at speeds above 20 mph (30 km/h), warning lamp ① on the corresponding side lights up red. This warning is always emitted when a vehicle enters the blind spot monitoring range from behind or from the side. When you overtake a vehicle, the warning only occurs if the difference in speed is less than 7 mph (12 km/h).

The yellow indicator lamp goes out if reverse gear is engaged. In this event, Blind Spot Assist is no longer active.

The brightness of the indicator/warning lamps is adjusted automatically according to the ambient light.

### Information in the Digital Operator's Manual

In the Digital Operator's Manual you can find information about:

- Collision warning
- Switching on Blind Spot Assist

## Lane Keeping Assist

### General notes

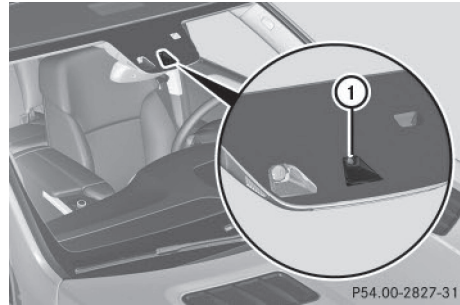

① Lane Keeping Assist camera

Lane Keeping Assist monitors the area in front of your vehicle with camera ①, which is mounted at the top of the windshield. Active Lane Keeping Assist detects lane markings on the road and can warn you before you leave your lane unintentionally.

This function is available in the range between 40 mph and 120 mph (60 km/h and 200 km/h).

A warning may be given if a front wheel passes over a lane marking. It will warn you by means of intermittent vibration in the steering wheel for up to 1.5 seconds.

### Important safety notes

#### WARNING

Lane Keeping Assist may not always clearly recognize lane markings.

In this case, Lane Keeping Assist may:

- give an unnecessary warning
- not give a warning

There is a risk of an accident.

Always pay particular attention to the traffic situation and stay in lane, in particular if warned by Lane Keeping Assist.

#### WARNING

The Lane Keeping Assist warning does not return the vehicle to the original lane. There is a risk of an accident.

You should always steer, brake or accelerate yourself, in particular if warned by Lane Keeping Assist.

If you fail to adapt your driving style, Lane Keeping Assist can neither reduce the risk of an accident nor override the laws of physics. Lane Keeping Assist cannot take into account the road, traffic and weather conditions. Lane Keeping Assist is merely an aid. You are responsible for the distance to the vehicle in front, for vehicle speed, for braking in good time and for staying in your lane.

The Lane Keeping Assist does not keep the vehicle in the lane.

The system may be impaired or may not function if:

- there is poor visibility, e.g. due to insufficient illumination of the road, or due to snow, rain, fog or spray
- there is glare, e.g. from oncoming traffic, the sun or reflections (e.g. when the road surface is wet)
- the windshield is dirty, fogged up, damaged or covered, for instance by a sticker, in the vicinity of the camera
- there are no, several or unclear lane markings for a lane, e.g. in areas with road construction work
- the lane markings are worn away, dark or covered up, e.g. by dirt or snow
- the distance to the vehicle in front is too small and the lane markings thus cannot be detected
- the lane markings change quickly, e.g. lanes branch off, cross one another or merge
- the road is narrow and winding
- there are strong shadows cast on the road

#### Switching on Lane Keeping Assist

You can find information about this in the Digital Operator's Manual.

### Active Driving Assistance package

#### General notes

The Active Driving Assistance package consists of DISTRONIC PLUS (▷ page 156), Active Blind Spot Assist (▷ page 180) and Active Lane Keeping Assist (▷ page 183).

#### Active Blind Spot Assist

##### General notes

Active Blind Spot Assist monitors the areas on either side of the vehicle that are not directly visible to the driver with two lateral, rear-facing radar sensors. A warning lamp lights up in the exterior mirrors and draws your attention to vehicles detected in the monitored area. If you then switch on the corresponding turn signal to change lanes, you will also receive a visual and audible collision warning. If a risk of lateral collision is detected, corrective braking may help you avoid a collision. Before a course-correcting brake application, Active Blind Spot Assist evaluates the space in the direction of travel and at the sides of the vehicle. For this, Active Blind Spot Assist uses the forward-facing radar sensors.

Active Blind Spot Assist supports you from a speed of approximately 20 mph (30 km/h).

##### Important safety notes

Active Blind Spot Assist is only an aid and is not a substitute for attentive driving.

#### WARNING

Active Blind Spot Assist does not react to:

- vehicles overtaken too closely on the side, placing them in the blind spot area
- vehicles which approach with a large speed differential and overtake your vehicle

As a result, Active Blind Spot Assist may neither give warnings nor intervene in such situations. There is a risk of an accident.

Always observe the traffic conditions carefully, and maintain a safe lateral distance.

**i** USA only: This device has been approved by the FCC as a "Vehicular Radar System". The radar sensor is intended for use in an automotive radar system only. Removal, tampering, or altering of the device will void any warranties, and is not permitted by the FCC. Do not tamper with, alter, or use in any non-approved way.

Any unauthorized modification to this device could void the user's authority to operate the equipment.

**i** Canada only: This device complies with RSS-210 of Industry Canada. Operation is subject to the following two conditions:

1. This device may not cause harmful interference, and
  2. This device must accept any interference received, including interference that may cause undesired operation of the device.
- Removal, tampering, or altering of the device will void any warranties, and is not permitted. Do not tamper with, alter, or use in any non-approved way.

Any unauthorized modification to this device could void the user's authority to operate the equipment.

### Radar sensors

The Active Blind Spot Assist radar sensors are integrated into the front and rear bumpers and behind a cover in the radiator trim. Make sure that the bumpers and the cover in the radiator grill are free of dirt, ice or slush. The sensors must not be covered, for example by cycle racks or overhanging loads. Following an accident or in the event of damage to the bumpers, have the function of the radar sensors checked at a qualified specialist workshop. Active Blind Spot Assist may otherwise no longer work properly.

### Monitoring area

#### WARNING

Active Blind Spot Assist does not detect all traffic situations and road users. There is a risk of an accident.

Always make sure that there is sufficient distance on the side for other traffic or obstacles.

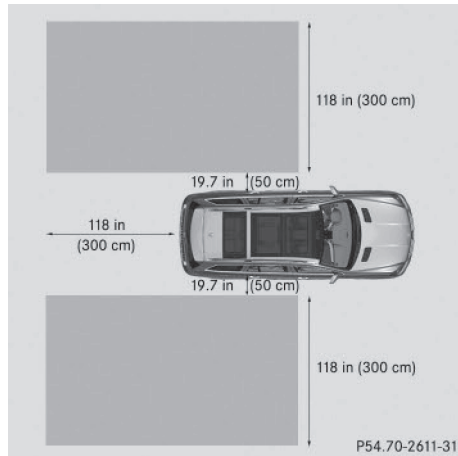

Active Blind Spot Assist monitors the area up to 10 ft (3.0 m) behind your vehicle and directly next to your vehicle, as shown in the diagram.

In particular, the detection of obstacles can be impaired if:

- there is dirt on the sensors or anything else covering the sensors
- poor visibility, e.g. due to rain, snow or spray

Vehicles in the monitoring range are then not reliably indicated.

Active Blind Spot Assist may not detect narrow vehicles, such as motorcycles or bicycles, or may only detect them too late.

If the lanes are narrow, vehicles driving in the lane beyond the lane next to your vehicle may be indicated, especially if the vehicles are not driving in the middle of their lane. This may be the case if there are vehicles at the edge of their lane.

Due to the nature of the system:

- warnings may be issued in error when driving close to crash barriers or similar solid lane borders.
- warnings may be interrupted when driving alongside particularly long vehicles, e.g. trucks, for a prolonged time.

### Indicator and warning display

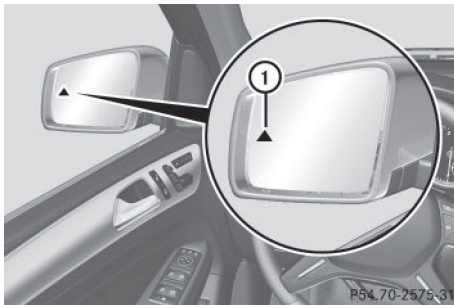

#### ① Yellow indicator lamp/red warning lamp

Active Blind Spot Assist is not active at speeds below approximately 20 mph (30 km/h). Vehicles in the monitoring range are then not indicated.

When Active Blind Spot Assist is activated, indicator lamp ① in the exterior mirrors lights up yellow at speeds of up to 20 mph (30 km/h). At speeds above 20 mph (30 km/h), the indicator lamp goes out and Active Blind Spot Assist is operational.

If a vehicle is detected within the monitoring range at speeds above approximately 20 mph (30 km/h), warning lamp ① on the corresponding side lights up red. This warning lamp always lights up when a vehicle enters the blind spot monitoring range from behind or from the side. When you overtake a vehicle with a difference in speed of less than 7 mph (12 km/h), a delayed warning occurs.

The yellow indicator lamp goes out if reverse gear is engaged. Active Blind Spot Assist is not operational.

The brightness of the indicator/warning lamps is adjusted automatically according to the brightness of the surroundings.

### Visual and acoustic collision warning

If you switch on the turn signals to change lanes and a vehicle is detected in the side monitoring range, you receive a visual and acoustic collision warning. You then hear a double warning tone and red warning lamp ① flashes. If the turn signal remains on, detected vehicles are indicated by the flashing of red warning lamp ①. There are no further warning tones.

### Course-correcting brake application

If Active Blind Spot Assist detects a risk of a lateral collision in the monitoring range, a course-correcting brake application is carried out. This is meant to assist you in avoiding a collision.

#### WARNING

A course-correcting brake application cannot always prevent a collision. There is a risk of an accident.

Always steer, brake or accelerate yourself, especially if Active Blind Spot Assist warns you or makes a course-correcting brake application. Always maintain a safe distance at the sides.

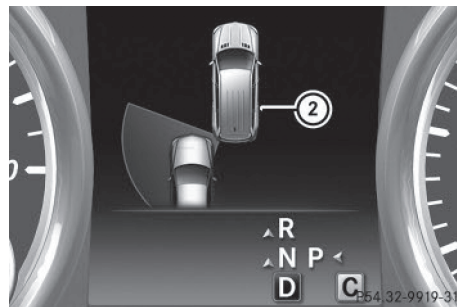

If a course-correcting brake application occurs, red warning lamp ① flashes in the exterior mirror and a dual warning tone sounds. In addition, display ② underlining the danger of a side collision appears in the multifunction display.

In very rare cases, the system may make an inappropriate brake application. A course-correcting brake application may be interrup-

ted at any time if you steer slightly in the opposite direction or accelerate.

The course-correcting brake application is available in the speed range between 20 mph (30 km/h) and 120 mph (200 km/h).

Either no braking application, or a course-correcting brake application adapted to the driving situation occurs if:

- there are vehicles or obstacles, e.g. crash barriers, close to both sides of your vehicle.
- a vehicle approaches you too closely at the side.
- you have adopted a sporty driving style with high cornering speeds.
- you brake or accelerate significantly.
- a driving safety system intervenes, e.g. ESP® or PRE-SAFE® Brake.
- ESP® is switched off.
- the off-road program is activated (vehicles without the ON&OFFROAD package).
- off-road program 1 or 2 is activated (vehicles with the ON&OFFROAD package).
- the LOW RANGE off-road gear is activated (vehicles with the ON&OFFROAD package).
- a loss of tire pressure or a defective tire is detected.

### Information in the Digital Operator's Manual

In the Digital Operator's Manual you can find information on:

- Switching on Active Blind Spot Assist
- Towing a trailer

## Active Lane Keeping Assist

### General notes

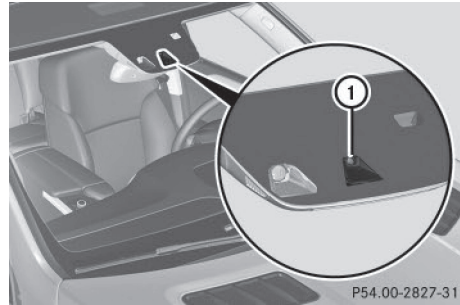

Active Lane Keeping Assist monitors the area in front of your vehicle by means of camera ① at the top of the windshield. Active Lane Keeping Assist detects lane markings on the road and warns you before you leave your lane unintentionally. If you do not react to the warning, a lane-correcting application of the brakes can bring the vehicle back into the original lane.

This function is available in a speed range between 40 mph and 120 mph (60 km/h and 200 km/h).

For Active Lane Keeping Assist to assist you when driving, the radar sensor system must be operational

### Important safety notes

If you fail to adapt your driving style, Active Lane Keeping Assist can neither reduce the risk of accident nor override the laws of physics. Active Lane Keeping Assist cannot take into account road, weather or traffic conditions. Active Lane Keeping Assist is only an aid. You are responsible for the distance to the vehicle in front, for vehicle speed, for braking in good time and for staying in your lane.

Active Lane Keeping Assist cannot continuously keep your vehicle in its lane.

#### **WARNING**

Active Lane Keeping Assist cannot always clearly detect lane markings.

In such cases, Active Lane Keeping Assist can:

- give an unnecessary warning and then make a course-correcting brake application to the vehicle
- not give a warning or intervene

There is a risk of an accident.

Always pay particular attention to the traffic situation and keep within the lane, especially if Active Lane Keeping Assist alerts you. Terminate the intervention in a non-critical driving situation.

The system may be impaired or may not function if:

- there is poor visibility, e.g. due to insufficient illumination of the road, or due to snow, rain, fog or spray
- there is glare, e.g. from oncoming traffic, the sun or reflections (e.g. when the road surface is wet)
- the windshield is dirty, fogged up, damaged or covered, for instance by a sticker, in the vicinity of the camera
- there are no, several or unclear lane markings for a lane, e.g. in areas with road construction work
- the lane markings are worn away, dark or covered up, e.g. by dirt or snow
- the distance to the vehicle in front is too small and the lane markings thus cannot be detected
- the lane markings change quickly, e.g. lanes branch off, cross one another or merge
- the road is narrow and winding
- there are highly variable shade conditions on the roadway
- no vehicle is detected in the adjacent lane and there are broken lane markings

#### Warning vibration in the steering wheel

A warning may be given if a front wheel passes over a lane marking. It will warn you by

means of intermittent vibration in the steering wheel for up to 1.5 seconds.

In order that you are warned only when necessary and in good time if you cross the lane marking, the system recognizes certain conditions and warns you accordingly.

The warning vibration occurs earlier if:

- you approach the outer lane marking on a bend.
- the road has very wide lanes, e.g. a highway.
- the system recognizes solid lane markings.

The warning vibration occurs later if:

- the road has narrow lanes.
- you cut the corner on a bend.

#### Lane-correcting brake application

##### WARNING

A lane-correcting brake application cannot always bring the vehicle back into the original lane. There is a risk of an accident.

Always steer, brake or accelerate yourself, especially if Active Lane Keeping Assist warns you or makes a lane-correcting brake application.

##### WARNING

Active Lane Keeping Assist does not detect traffic conditions or road users. In very rare cases, the system may make an inappropriate brake application, e.g. after intentionally driving over a solid lane marking. There is a risk of an accident.

An inappropriate brake application may be interrupted at any time if you steer slightly in the opposite direction. Always make sure that there is sufficient distance on the side for other traffic or obstacles.



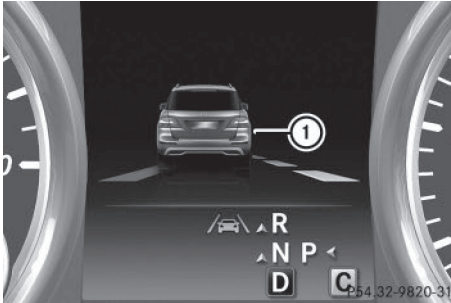

If you leave your lane, under certain circumstances the vehicle will brake briefly on one side. This is meant to assist you in bringing the vehicle back to the original lane.

If a lane-correcting brake application occurs, display ① appears in the multifunction display.

A lane-correcting brake application can only be made after driving over a solid, recognizable lane marking. Before this, a warning must be given by means of intermittent vibration in the steering wheel. In addition, a lane with lane markings on both sides must be recognized. The brake application also slightly reduces vehicle speed.

- ❗ A further lane-correcting brake application can only occur after your vehicle has returned to the original lane.

No lane-correcting brake application occurs if:

- you clearly and actively steer, brake or accelerate.
- you cut the corner on a sharp bend.
- you have switched on the turn signal.
- a driving safety system intervenes, e.g. ESP®, PRE-SAFE® Brake or Active Blind Spot Assist.
- you have adopted a sporty driving style with high cornering speeds or high rates of acceleration.
- ESP® is switched off.
- the transmission is not in position **D**.

- on vehicles with a trailer tow hitch, the electrical connection to the trailer has been correctly established.
- the off-road program is activated (vehicles without the ON&OFFROAD package).
- off-road program 1 or 2 is activated (vehicles with the ON&OFFROAD package).
- the LOW RANGE off-road gear is activated (vehicles with the ON&OFFROAD package).
- when a loss of tire pressure or a defective tire has been detected and displayed.

There is a possibility that the Active Lane Keeping Assist could misjudge the given traffic situation. An inappropriate brake application may be interrupted at any time if you:

- steer slightly in the opposite direction
- switch on the turn signal
- clearly brake or accelerate

A lane-correcting brake application is interrupted automatically if:

- a driving safety system intervenes, e.g. ESP®, PRE-SAFE® Brake or Active Blind Spot Assist.
- lane markings can no longer be recognized.

### Information in the Digital Operator's Manual

In the Digital Operator's Manual you can find information on:

- Switching on Active Lane Keeping Assist
- Towing a trailer



### On-road programs (vehicles with the ON&OFFROAD package)

#### General notes

The on-road programs assist you during on-road driving and the off-road programs when driving off-road (> page 188).

The following program messages remain in the multifunction display until the corresponding vehicle level has been set. Up to off-road level 2, you can hide the program mes-



sages using the  or  button on the multifunction steering wheel.

### AUTO program

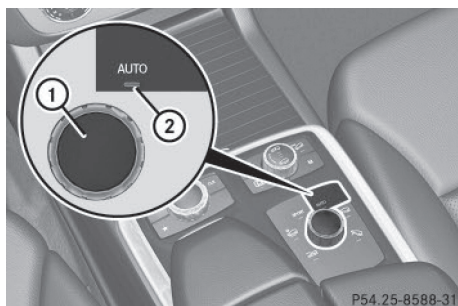

- ① On-road program selector wheel
- ② AUTO program indicator lamp

### SPORT program

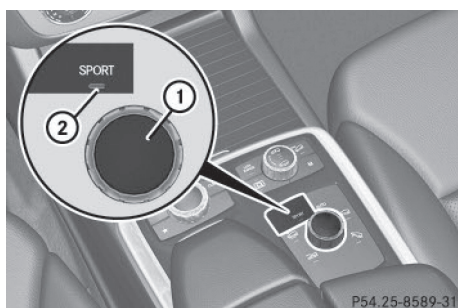

- ① On-road program selector wheel
- ② SPORT program indicator lamp

### Snow program

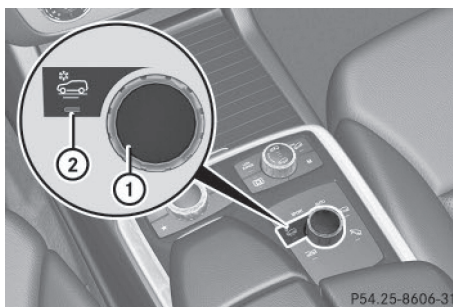

- ① On-road program selector wheel
- ② Snow program indicator lamp

### Trailer program

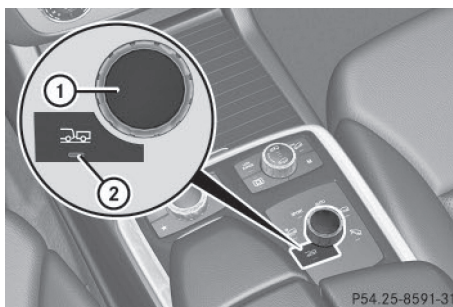

- ① On-road program selector wheel
- ② Trailer program indicator lamp

## Off-road driving systems

### 4MATIC (permanent four-wheel drive)

4MATIC ensures that all four wheels are permanently driven. Together with ESP® and 4ETS, it improves the traction of your vehicle whenever a drive wheel spins due to insufficient grip.

If you fail to adapt your driving style, 4MATIC can neither reduce the risk of accident nor override the laws of physics. 4MATIC cannot take account of road, weather and traffic conditions. 4MATIC is only an aid. You are responsible for the distance to the vehicle in

front, for vehicle speed, for braking in good time and for staying in your lane.

**!** Never tow the vehicle with one axle raised. This may damage the transfer case. Damage of this sort is not covered by the Mercedes-Benz Limited Warranty. All wheels must remain either on the ground or be fully raised. Observe the instructions for towing the vehicle with all wheels in full contact with the ground.

**!** A function or performance test should only be carried out on a two-axle dynamometer. Before you operate the vehicle on such a dynamometer, please consult a qualified workshop. You could otherwise damage the drive train or the brake system.

**i** In wintry driving conditions, the maximum effect of 4MATIC can only be achieved if you use winter tires (M+S tires), with snow chains if necessary.

Further information about "Driving off-road" (> page 152).

## DSR (Downhill Speed Regulation)

### General notes

DSR is an aid to assist you when driving downhill. It keeps the speed of travel at the speed selected on the on-board computer. The steeper the downhill gradient, the greater the DSR braking effect on the vehicle. When driving on flat stretches of road or on an uphill gradient, the DSR braking effect is minimal or nonexistent.

DSR controls the vehicle's speed when it is activated and the transmission is in position **D**, **R** or **N**. You can drive at a higher or a lower speed than that set on the on-board computer at any time by accelerating or braking.

### Important safety notes

#### WARNING

If the speed driven and the set speed deviate and you activate DSR on a slippery road sur-

face, the wheels may lose traction. There is an increased danger of skidding and accidents.

Before switching DSR on, please take into consideration the road surface and the difference between driving speed and the set speed.

If you fail to adapt your driving style, DSR can neither reduce the risk of accident nor override the laws of physics. DSR cannot take account of road, weather and traffic conditions. DSR is only an aid. You are responsible for the distance to the vehicle in front, for vehicle speed, for braking in good time and for staying in your lane.

You are always responsible for keeping control of the vehicle and for assessing whether the downhill gradient can be managed. DSR may not always be able to keep to the set speed, depending on road surface and tire conditions. Select a set speed suitable for the prevailing conditions and when necessary, apply the brakes manually.

### General notes

DSR assists you when driving downhill. It keeps the speed of travel at the speed set on the on-board computer. The steeper the downhill gradient, the greater the DSR braking effect on the vehicle. When driving on flat stretches of road or on an uphill gradient, the DSR braking effect is minimal or nonexistent. DSR controls the set speed when it is active and the automatic transmission is in the **D**, **R** or **N** position. By accelerating or braking, you can always drive at a higher or a lower speed than that set on the on-board computer.

Further information about "Driving off-road" (> page 152).

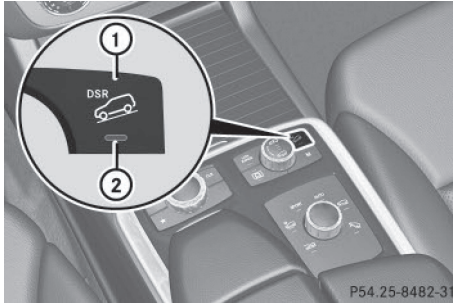

Example: vehicles with the ON&OFFROAD package

- ① DSR button
- ② DSR indicator lamp

In the Digital Operator's Manual you can find information about:

- Activating DSR
- Deactivating DSR
- Changing the set speed

### Off-road programs (vehicles with the ON&OFFROAD package)

#### General notes

The off-road programs assist you in driving off-road. The engine's performance characteristics and the gearshifting characteristics of the automatic transmission are adapted for this purpose. ABS, ESP® and 4ETS programs especially adapted to off-road driving are activated. An accelerator pedal curve suitable for the terrain is selected, i.e. the accelerator pedal must be depressed further to accelerate.

Do not use the off-road programs on roads that are snow-covered or icy or if you have mounted snow chains on your vehicle.

For information on driving off-road, see (▷ page 152).

### Off-road program 1

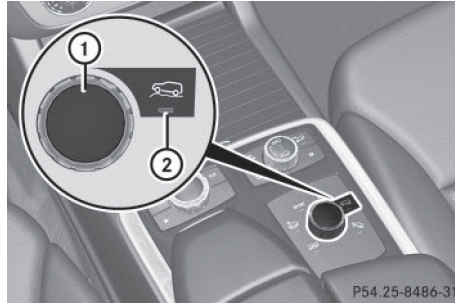

- ① Selector wheel
- ② Off-road program indicator lamp 1

### Off-road program 2

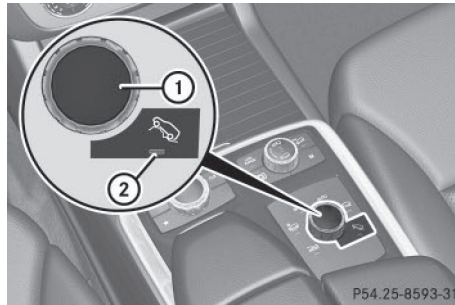

- ① Selector wheel
- ② Off-road program indicator lamp 2

### LOW RANGE off-road gear (vehicles with the ON&OFFROAD package)

#### Important safety notes

#### ⚠ WARNING

If you select the LOW RANGE off-road gear on a slippery road surface, the wheels could lose traction:

- if you remove your foot from the accelerator pedal when driving
- if off road ABS intervenes when braking

If the wheels lose traction, the vehicle can no longer be steered. There is an increased danger of skidding and accidents.

Never select the LOW RANGE off-road gear when driving on slippery road surfaces.

### WARNING

If you do not wait for the transfer case gear change process to complete, the transfer case could remain in the neutral position. The power transmission to the driven wheels is then interrupted. There is a danger of the vehicle rolling away unintentionally. There is a risk of an accident.

Wait until the transfer case shift process is completed.

Do not turn off the engine while changing gear and do not shift the automatic transmission to another position.

### General notes

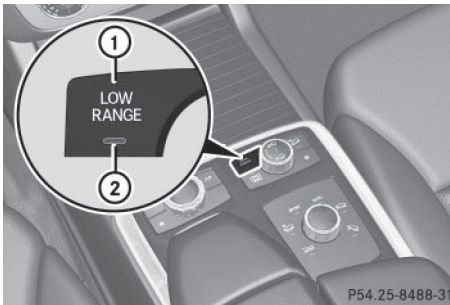

- ① LOW RANGE off-road gear button
- ② LOW RANGE off-road gear indicator lamp

The LOW RANGE off-road gear assists you in driving off-road and when fording. When LOW RANGE is engaged, the engine's performance characteristics and the gearshifting characteristics of the automatic transmission are adapted for this purpose.

### From HIGH RANGE to LOW RANGE

**!** Only change from LOW RANGE to HIGH RANGE if:

- the engine is running.
- the transmission is in position **N**
- you are driving at a speed below 40 km/h

### From LOW RANGE to HIGH RANGE

**!** Only change from LOW RANGE to HIGH RANGE if:

- the engine is running.
- the transmission is in position **N**
- you are driving at a speed below 70 km/h

### ON&OFFROAD menu in the COMAND display (vehicles with the ON&OFF-ROAD package)

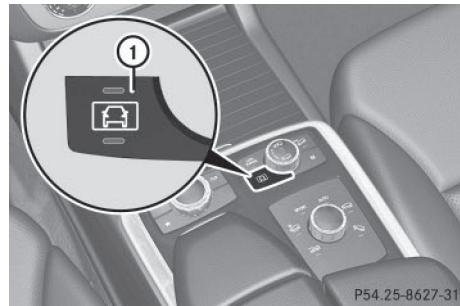

You can display some driving systems, driving programs and additional information in the COMAND display.

- ▶ Make sure that the SmartKey is in position **2** in the ignition lock.
- ▶ Make sure that COMAND is activated, see the separate COMAND operating instructions.
- ▶ Press function button ①.
  - The corresponding displays appear in the COMAND display:
    - Level control
    - Steering angle
    - Vehicle's angle of inclination
    - Uphill or downhill gradient in percentage
    - On-road/off-road program selected
    - Condition of the differential lock for the transfer case
    - LOW RANGE off-road gear is selected
    - Condition of the LOW RANGE off-road gear
    - On-road trailer program is selected

## Towing a trailer

### Important safety notes

#### WARNING

Installing an unsuitable ball coupling may result in overloading of the trailer tow hitch and the rear axle. This applies especially if the ball coupling in question is longer or angled differently. This could seriously impair the driving characteristics and the trailer can come loose. There is a risk of an accident. You should only ever install a ball coupling that has the permissible dimensions and that is designed to meet your trailer-towing requirements. Do not modify the ball coupling or the trailer tow hitch.

You will find the values approved by the manufacturer on the vehicle identification plates and those for the towing vehicle under "Technical data" (▷ page 344).

#### WARNING

If the ball coupling is not installed correctly or not secured with the bolt provided and the corresponding spring cotter, the trailer may come loose. There is a risk of an accident.

Always install and secure the ball coupling as described. Before every journey, ensure that the ball coupling is secured with the bolt and the corresponding spring cotter.

#### WARNING

When the vehicle/trailer combination begins to lurch, you could lose control of it. The vehicle/trailer combination could even rollover. There is a risk of an accident.

On no account should you attempt to straighten up the vehicle/trailer combination by increasing the speed. Reduce vehicle speed and do not countersteer. Apply the brake as necessary.

Please observe the manufacturer's operating instructions for the trailer coupling if a detachable trailer coupling is used.

Couple and uncouple the trailer carefully. If you do not couple the trailer to the towing vehicle correctly, the trailer could become detached.

Make sure that the following values are not exceeded:

- the permissible trailer drawbar noseweight
- the permissible trailer load
- the permissible rear axle load of the towing vehicle
- the maximum permissible gross vehicle weight of both the towing vehicle and the trailer

The applicable permissible values, which must not be exceeded, can be found:

- in the vehicle documents
- on the identification plates for the trailer tow hitch and the trailer
- on the vehicle identification plate

If the values differ, the lowest value applies.

When towing a trailer, your vehicle's handling characteristics will be different in comparison with when driving without a trailer.

The vehicle/trailer combination:

- is heavier
- is restricted in its acceleration and gradient-climbing capability
- has an increased braking distance
- is affected more by strong crosswinds
- demands more sensitive steering
- has a larger turning radius

This could impair the handling characteristics.

When towing a trailer, always adjust your speed to the current road and weather conditions. Do not exceed the maximum permissible speed for your vehicle/trailer combination.



## Notes on towing a trailer

### General notes

The following models cannot be used to tow a trailer:

- GLE 550 e 4MATIC Sport Utility Vehicle
- Do not exceed the legally prescribed maximum speed for vehicle/trailer combinations in the relevant country.

This lowers the risk of an accident.

- Only install an approved trailer coupling on your vehicle.

Further information on availability and on installation is available from any authorized Mercedes-Benz Center.

- The bumpers of your vehicle are not suitable for installing detachable trailer couplings.
- Do not install hired trailer couplings or other detachable trailer couplings on the bumpers of your vehicle.
- If you no longer need the ball coupling, remove it from the ball coupling recess. This will reduce the risk of damage to the ball coupling.

When towing a trailer, set the tire pressure on the rear axle of the towing vehicle for the maximum load. You will find the values in the tire pressure table in the fuel filler flap of the vehicle (▷ page 312).

Please note that when towing a trailer, the following driving systems have limited availability or are not available at all:

- PARKTRONIC (▷ page 168)
- Blind Spot Assist (▷ page 177)
- Active Lane Keeping Assist (▷ page 183)

You will find installing dimensions and loads under "Technical data" (▷ page 343).

### Driving tips

Observe the information on ESP® trailer stabilization (▷ page 81) and on pulling away with a trailer (▷ page 138).

The maximum permissible speed for vehicle/trailer combinations depends on the type of trailer. Before beginning the journey, check the trailer's documents to see what the maximum permissible speed is. Observe the legally prescribed maximum speed in the relevant country.

For certain Mercedes-Benz vehicles, the maximum permissible rear axle load is increased when towing a trailer. See "Technical data" to find out whether this applies to your vehicle (▷ page 344). If you utilize any of the added maximum rear axle load when towing a trailer, the vehicle/trailer combination may not exceed a maximum speed of 60 mph (100 km/h) for reasons concerning the operating permit. This also applies in countries in which the permissible maximum speed for vehicle/trailer combinations is above 60 mph (100 km/h).

When towing a trailer, your vehicle's handling characteristics will be different in comparison with when driving without a trailer.

Use the left-hand steering wheel paddle shifter to shift into a lower gear in good time on long and steep downhill gradients.

This also applies if you have activated cruise control or DISTRONIC PLUS.

This will use the braking effect of the engine, so that less braking will be required to maintain the speed. This relieves the load on the brake system and prevents the brakes from overheating and wearing too quickly. If you need additional braking, depress the brake pedal repeatedly rather than continuously.

### Driving tips

If the trailer swings from side to side:

- ▶ Do not accelerate.
- ▶ Do not counter-steer.
- ▶ Brake if necessary.

- Maintain a greater distance from the vehicle in front than when driving without a trailer.
- Avoid braking abruptly. If possible, brake gently at first to allow the trailer to run on. Then, increase the braking force rapidly.
- The values given for gradient-climbing capabilities from a standstill refer to sea level. When driving in mountainous areas, note that the power output of the engine and, consequently, the vehicle's gradient-climbing capability, decreases with increasing altitude.

### Installing the ball coupling

#### WARNING

If the ball coupling is not correctly installed and secured, it can come loose during the journey and endanger other road users. There is a risk of an accident and injury.

Always install and secure the ball coupling as described. Before every journey, ensure that the ball coupling is secured with the bolt and the corresponding spring cotter.

#### WARNING

If the ball coupling is not installed correctly or not secured with the bolt provided and the corresponding spring cotter, the trailer may come loose. There is a risk of an accident.

Always install and secure the ball coupling as described. Before every journey, ensure that the ball coupling is secured with the bolt and the corresponding spring cotter.

#### WARNING

If the ball coupling is not installed and secured correctly the trailer may come loose. There is a risk of an accident.

Install and secure the ball coupling as described in the ball coupling installation instructions. Make sure that the ball coupling is installed and secured correctly before every journey.

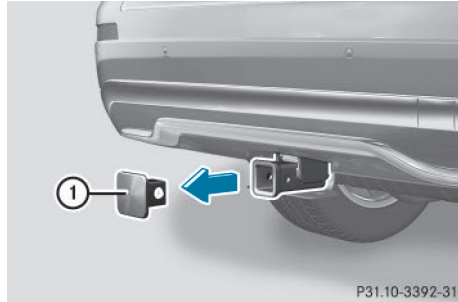

P31.10-3392-31

- ▶ Pull protective cap ① in the direction of the arrow, out of the ball coupling recess.
- ▶ Stow protective cap ① so that it cannot be thrown around.

Observe the loading guidelines (▷ page 248) and the safety notes regarding stowage spaces (▷ page 249).

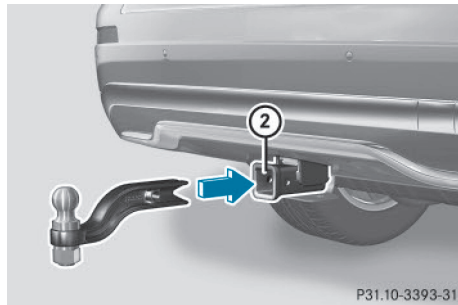

P31.10-3393-31

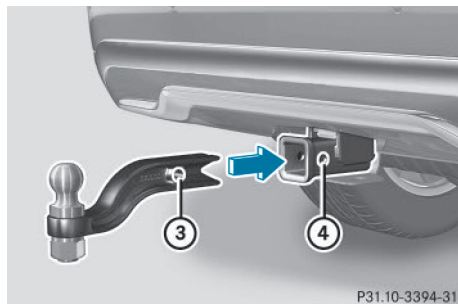

P31.10-3394-31

- ▶ Insert the ball coupling horizontally into ball coupling recess ② in the direction of the arrow until the holes in ball coupling ③ are in line with the holes in ball coupling recess ④.



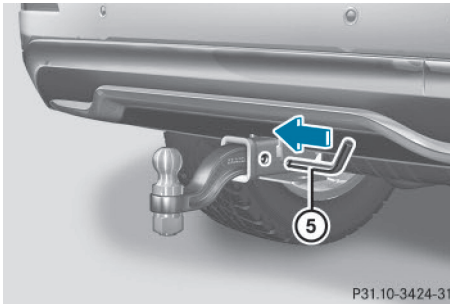

- ▶ Slide bolt ⑤ into the hole in the ball coupling recess and the ball coupling to the stop.

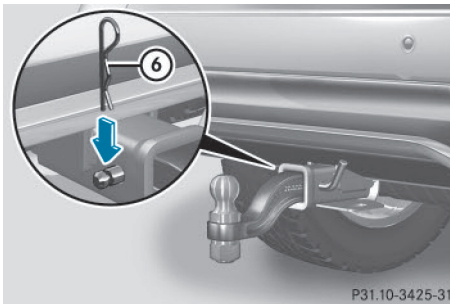

- ▶ Secure the bolt using spring cotter ⑥.

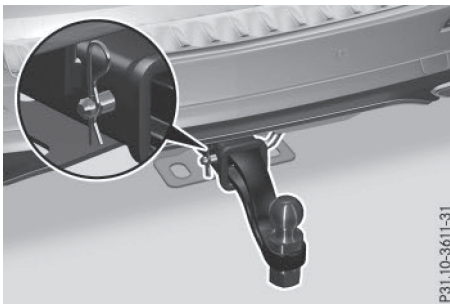

- ▶ Check the ball coupling, bolt and spring cotter for correct installation.

If the ball coupling cannot be correctly mounted, remove the ball coupling. Under these circumstances, the ball coupling must not be used for trailer towing.

If the ball coupling cannot be locked and the key cannot be removed, remove the ball coupling and clean it. If the ball coupling can still

not be installed (locked) after it has been cleaned, remove the ball coupling. The trailer tow hitch must then not be used to tow a trailer, as safe operation cannot be guaranteed.

Have the entire trailer tow hitch checked at a qualified specialist workshop.

### Coupling up a trailer

**!** Do not connect the trailer's brake system (if featured) to the hydraulic brake system of the towing vehicle, as the latter is equipped with an anti-lock brake system. Doing so will result in a loss of function of the brake systems of both the vehicle and the trailer.

- ▶ Shift the transmission to position **P**.
- ▶ Apply the vehicle's electric parking brake.
- ▶ Start the engine.
- ▶ **Vehicles with the AIRMATIC package:** select highway level.
- ▶ **Vehicles with ADS:** set ADS to **AUTO** or **COMF**.
- ▶ Switch off the engine.
- ▶ Close the doors and tailgate.
- ▶ Couple up the trailer.
- ▶ Establish the electrical connection between the vehicle and the trailer.
- ▶ Check that the trailer lighting system is working.

**i** Vehicles with the AIRMATIC package: with a trailer attached, the vehicle will always remain at highway level. When coupling up a trailer, please observe the following:

- Unless highway level has been set manually, the vehicle is automatically lowered to highway level. This is the case if a speed of 5 mph (8 km/h) is reached.
- High-speed level is not available.

These restrictions apply to all accessories powered through a connection to the trailer

power socket of your vehicle, e.g. a bicycle carrier.

Observe the maximum permissible trailer dimensions (width and length).

Most U.S. states and all Canadian provinces require by law:

- Safety chains between the towing vehicle and the trailer. The chains should be cross-wound under the trailer drawbar. They must be fastened to the vehicle's trailer coupling, not to the bumper or the axle.

Leave enough play in the chains to make tight cornering possible.

- A separate brake system for certain types of trailer.
- Safety switch for braked trailers. Check the specific legal requirements applicable to your state.

If the trailer becomes detached from the towing vehicle, the safety switch applies the trailer brakes.

### Towing a trailer

There are numerous legal requirements concerning the towing of a trailer, e.g. speed restrictions. Make sure that your car/trailer combination complies with the local regulations:

- in your place of residence
- in the location to which you are driving

The police and local authorities can provide reliable information.

Observe the following when towing a trailer:

- To gain driving experience and to become accustomed to the new handling charac-

teristics, you should practice the following in a traffic-free location:

- cornering
- stopping
- backing up
- Before driving, check:
  - trailer tow hitch
  - safety switch for braked trailers
  - safety chains
  - electrical connections
  - lights
  - wheels
- Adjust the exterior mirrors to provide an unobstructed view of the rear section of the trailer.
- If the trailer has electronically controlled brakes, pull away carefully. Brake manually using the brake controller and check whether the brakes function correctly.
- Secure any objects on the trailer to prevent the cargo from slipping when the vehicle is in motion.
- When you couple up a trailer, check at regular intervals that the load is firmly secured. If the trailer is equipped with trailer lights and brakes, check the trailer to ensure that these are working.
- Bear in mind that the handling will be less stable when towing a trailer than when driving without one. Avoid sudden steering movements.
- The vehicle/trailer combination is heavier, accelerates more slowly, has a decreased gradient climbing capability and a longer braking distance.
  - It is more susceptible to side winds and requires more careful steering.
- If possible, do not brake suddenly, but instead depress the brake pedal moderately at first so that the trailer can activate its brakes. Then increase the pressure on the brake pedal.
- If the automatic transmission repeatedly shifts between gears on uphill or downhill

gradients, shift to a lower gear using the left-hand steering wheel paddle shifter.

A lower gear and lower speed reduce the risk of engine failure.

- When driving downhill, shift to a lower gear to utilize the engine's braking effect. Avoid continuous brake application as this may overheat the vehicle brakes and, if installed, the trailer brakes.
- If the coolant temperature increases dramatically while the air-conditioning system is switched on, switch off the air-conditioning system. Coolant heat can also be dissipated by opening the windows and switching the ventilation blower and the interior temperature to the highest level.
- When overtaking, pay particular attention to the extended length of your vehicle/trailer combination.

Due to the length of the vehicle/trailer combination, you require additional road space in relation to the vehicle you are overtaking before you can change back to the original lane.

### Decoupling a trailer

#### WARNING

If you uncouple a trailer with the overrun brake engaged, you could trap your hand between the vehicle and the trailer drawbar. There is a risk of injury.

Do not uncouple a trailer if the overrun brake is engaged.

#### WARNING

Vehicles with level control:

The vehicle is lowered as soon as you disconnect the trailer cable. This could result in your limbs or those of other people that are between the vehicle body and tires or underneath the vehicle being trapped. There is a risk of injury.

Make sure that nobody is in the immediate vicinity of the wheel housings or under the vehicle when you disconnect the trailer cable.

- ❗ Do not disconnect a trailer with an engaged overrun brake. Otherwise, your vehicle could be damaged by the rebounding of the overrun brake.
- ▶ Shift the transmission to position **P**.
- ▶ Apply the vehicle's electric parking brake.
- ▶ Start the engine.
- ▶ Close the doors and tailgate.
- ▶ Apply the trailer's parking brake.
- ▶ Detach the trailer cable and decouple the trailer.
- ▶ Switch off the engine.

### Permissible trailer loads and drawbar loads

#### Weight specifications

##### Maximum permissible gross vehicle weight rating

The gross trailer weight is calculated by adding the weight of the trailer to the weight of the load and equipment on the trailer.

You will find installing dimensions and loads under "Technical data" (▷ page 343).

##### Permissible noseweight

You will find installing dimensions and loads under "Technical data" (▷ page 343).

#### Loading a trailer

- When loading the trailer, make sure that neither the permissible gross weight of the trailer nor the gross vehicle weight is exceeded. The permissible gross vehicle weight is indicated on the identification plate on the B-pillar on the driver's side of the vehicle. You can find the maximum permissible values on the type plates of your vehicle and

the trailer. When calculating how much weight the vehicle and trailer may carry, pay attention to the respective lowest values.

- The trailer drawbar load on the ball coupling must be added to the rear axle load to avoid exceeding the permissible gross axle weight. The permissible gross vehicle weight is indicated on the identification plate on the B-pillar on the driver's side of the vehicle.
- ❗ Mercedes-Benz recommends a trailer load where the trailer drawbar noseweight accounts for 8% to 15% of the trailer's permissible gross weight.
- ❗ The weight of additional accessories, passengers, and cargo reduces the permissible trailer load and drawbar load for your vehicle.

### Checking the vehicle and trailer weight

- To check that the weights of the towing vehicle and the trailer comply with the maximum permissible values, have the vehicle / trailer combination (including the driver, passengers, and cargo with a fully laden trailer) weighed on a calibrated weigh-bridge.
- Check the gross axle weight rating of the front and rear axles, the gross weight of the trailer and trailer drawbar load.

### Removing the ball coupling

- ▶ Remove the spring cotter.
- ▶ Remove the bolt from the ball coupling recess.
- ▶ Remove the ball coupling from the ball coupling recess.
- ▶ Clean the ball coupling if it is dirty.
- ▶ Stow the ball coupling so that it cannot be thrown around.

Observe the loading guidelines (▷ page 248) and the safety notes regarding stowage spaces (▷ page 249).

Information on cleaning and care of the trailer tow hitch (▷ page 272).

### Trailer power supply

You can find information about this in the Digital Operator's Manual.

Useful information .....	198
Important safety notes .....	198
Displays and operation .....	198
Menus and submenus .....	199
Display messages .....	201
Warning and indicator lamps in the instrument cluster .....	214

### Useful information

- i** This Operator's Manual describes all models and all standard and optional equipment of your vehicle available at the time of publication of the Operator's Manual. Country-specific differences are possible. Please note that your vehicle may not be equipped with all features described. This also applies to safety-related systems and functions.
- i** Read the information on qualified specialist workshops (▷ page 35).

### Important safety notes

#### **⚠ WARNING**

If you operate information systems and communication equipment integrated in the vehicle while driving, you will be distracted from traffic conditions. You could also lose control of the vehicle. There is a risk of an accident. Only operate the equipment when the traffic situation permits. If you are not sure that this is possible, park the vehicle paying attention to traffic conditions and operate the equipment when the vehicle is stationary.

You must observe the legal requirements for the country in which you are currently driving when operating the on-board computer.

#### **⚠ WARNING**

If the instrument cluster has failed or malfunctioned, you may not recognize function restrictions in systems relevant to safety. The operating safety of your vehicle may be impaired. There is a risk of an accident. Drive on carefully. Have the vehicle checked at a qualified specialist workshop immediately.

If the operating safety of your vehicle is impaired, pull over as soon as it is safe to do so. Contact a qualified specialist workshop.

The on-board computer only shows messages or warnings from certain systems in the multifunction display. You should therefore make sure your vehicle is operating safely at all times.

For an overview, see the instrument panel illustration (▷ page 41).

### Displays and operation

#### Information in the Digital Operator's Manual

In the Digital Operator's Manual you will find information on the following topics:

- Coolant temperature display
- Tachometer
- Speedometer with segments
- Multifunction display
- Outside temperature display

### Operating the on-board computer

#### Overview



- ① Multifunction display
- ② Switches on the Voice Control System (see the separate operating instructions)
- ③ Right control panel

- ④ Left control panel
- ⑤ Back button

► **To activate the on-board computer:** turn the SmartKey to position **1** in the ignition lock.

You can control the multifunction display and the settings in the on-board computer using the buttons on the multifunction steering wheel.

### Left control panel

◀	• Calls up the menu and menu bar
▶	
▲	<b>Press briefly:</b>
▼	<ul style="list-style-type: none"> <li>• Scrolls in lists</li> <li>• Selects a submenu or function</li> <li>• In the <b>Audio</b> menu: selects a stored station, an audio track or a video scene</li> <li>• In the <b>Tel</b> (Telephone) menu: switches to the phone book and selects a name or telephone number</li> </ul>
▲	<b>Press and hold:</b>
▼	<ul style="list-style-type: none"> <li>• In the <b>Audio</b> menu: selects the previous/next station or selects an audio track or a video scene using rapid scrolling</li> <li>• In the <b>Tel</b> (Telephone) menu: starts rapid scrolling if the phone book is open</li> </ul>
OK	<ul style="list-style-type: none"> <li>• Confirms the selection or display message</li> <li>• In the <b>Tel</b> (Telephone) menu: switches to the telephone book and starts dialing the selected number</li> <li>• In the <b>Audio</b> menu: stops the station search function at the desired station</li> </ul>

### Right control panel

	<ul style="list-style-type: none"> <li>• Rejects or ends a call</li> <li>• Exits the telephone book/redial memory</li> </ul>
	<ul style="list-style-type: none"> <li>• Makes or accepts a call</li> <li>• Switches to the redial memory</li> </ul>
+ -	• Adjusts the volume
	• Mute
	<ul style="list-style-type: none"> <li>• Vehicles with Audio 20: Switches on voice-operated control for navigation (see manufacturer's operating instructions)</li> <li>• Vehicles with COMAND: Switches on the Voice Control System (see the separate operating instructions)</li> </ul>

### Back button

	<b>Press briefly:</b>
	<ul style="list-style-type: none"> <li>• Back</li> <li>• Switches off the Voice Control System (see the separate operating instructions)</li> <li>• Hides display messages or calls up the last <b>Trip</b> menu function used</li> <li>• Exits the telephone book/redial memory</li> </ul>
	<b>Press and hold:</b>
	• Calls up the standard display in the <b>Trip</b> menu

## Menus and submenus

### Menu overview

Press the or button on the steering wheel to call up the menu bar and select a menu.



Operating the on-board computer  
(▷ page 198).

You can find more information on the individual menus in the Digital Operator's Manual.

Depending on the equipment installed in the vehicle, you can call up the following menus:

- **Trip** menu
- **Navi** menu (navigation instructions)
- **Audio** menu
- **Tel** menu (telephone)
- **Assist.** menu (assistance)
- **Serv.** menu
- **Settings** menu
- **ON&OFFROAD** menu
- **AMG** menu (Mercedes-AMG vehicles)

## Display messages

### Introduction

#### General notes

This section describes display messages relevant to safety together with their solutions. A description of other messages and their solutions can be found in the Digital Operator's Manual.

Display messages appear in the multifunction display.



Display messages with graphic displays may be shown in simplified form in the Operator's Manual and may therefore differ from the multifunction display.

Please respond in accordance with the display messages and follow the additional notes in this Operator's Manual.

Certain display messages are accompanied by an audible warning tone or a continuous tone.

When you stop and park the vehicle, please observe the notes on the HOLD function (> page 164) and parking (> page 148).

#### Hiding display messages







- ▶ Press the  or  button on the steering wheel.  
The multifunction display hides the display message.

High-priority display messages are shown in red in the multifunction display. Some high-priority display messages cannot be hidden.

The multifunction display shows these messages continuously until the causes for the messages have been remedied.

#### Message memory

The on-board computer saves certain display messages in the **message memory**. You can call up the display messages:

- ▶ Press  or  on the steering wheel to select the **Serv.** menu.  
If there are display messages, the multifunction display shows **2 Messages**, for example.
- ▶ Press the  or  button to select the entry, e.g. **2 messages**.
- ▶ Press  to confirm.
- ▶ Press the  or  button to scroll through the display messages.

When the ignition is switched off, all display messages are deleted, apart from some high-priority display messages. Once the causes of the high-priority display messages have been rectified, the corresponding display messages are also deleted.

## Safety systems

## Display messages



Currently Unavailable See Operator's Manual

## Possible causes/consequences and ► Solutions

ABS (Anti-lock Brake System), BAS (Brake Assist), ESP® (Electronic Stability Program), ESP® trailer stabilization, PRE-SAFE®, the HOLD function, hill start assist, Crosswind Assist, STEER CONTROL, Active Lane Keeping Assist and Active Blind Spot Assist are temporarily unavailable.

COLLISION PREVENTION ASSIST, BAS PLUS and PRE-SAFE® Brake may also have failed.

In addition, the ,  and  warning lamps light up in the instrument cluster.

ATTENTION ASSIST is deactivated.

Possible causes are:

- Self-diagnosis is not yet complete.
- the on-board voltage may be insufficient.

 **WARNING**

The brake system continues to function normally, but without the functions listed above. The wheels could therefore lock if you brake hard, for example.

The steerability and braking characteristics may be severely affected. The braking distance in an emergency braking situation can increase.

If ESP® is not operational, ESP® is unable to stabilize the vehicle. There is an increased risk of skidding and an accident.

► Carefully drive a suitable distance, making slight steering movements at a speed above 12 mph (20 km/h).

If the display message disappears, the functions mentioned above are available again.

If the multifunction display still shows the display message:





- Drive on carefully.
- Visit a qualified specialist workshop.







Inoperative See Operator's Manual

ABS, BAS, ESP®, ESP® trailer stabilization, PRE-SAFE®, the HOLD function, hill start assist, Crosswind Assist, STEER CONTROL, Active Lane Keeping Assist and Active Blind Spot Assist are unavailable due to a malfunction.

COLLISION PREVENTION ASSIST, BAS PLUS and PRE-SAFE® Brake may also have failed.

The  (USA only) or  (Canada only), ,  and  warning lamps in the instrument cluster also light up.

ATTENTION ASSIST is deactivated.

Display messages	Possible causes/consequences and ► Solutions
	<p> <b>WARNING</b></p> <p>The brake system continues to function normally, but without the functions listed above. The wheels could therefore lock if you brake hard, for example.</p> <p>The steerability and braking characteristics may be severely affected. The braking distance in an emergency braking situation can increase.</p> <p>If ESP® is not operational, ESP® is unable to stabilize the vehicle. There is an increased risk of skidding and an accident.</p> <ul style="list-style-type: none"> <li>► Drive on carefully.</li> <li>► Visit a qualified specialist workshop immediately.</li> </ul>
<p>                      Currently unavailable See Operator's Manual</p>	<p>ESP®, ESP® trailer stabilization, BAS, PRE-SAFE®, the HOLD function, hill start assist, Crosswind Assist, STEER CONTROL, Active Lane Keeping Assist and Active Blind Spot Assist are unavailable due to a malfunction.</p> <p>COLLISION PREVENTION ASSIST, BAS PLUS and PRE-SAFE® Brake may also have failed.</p> <p>In addition, the  and  warning lamps light up in the instrument cluster.</p> <p>The self-diagnosis function might not be complete, for example. ATTENTION ASSIST is deactivated.</p> <p> <b>WARNING</b></p> <p>The brake system continues to function normally, but without the functions listed above. The wheels could therefore lock if you brake hard, for example.</p> <p>The braking distance in an emergency braking situation can thus increase.</p> <p>If ESP® is not operational, ESP® is unable to stabilize the vehicle. There is an increased risk of skidding and an accident.</p> <ul style="list-style-type: none"> <li>► Carefully drive a suitable distance, making slight steering movements at a speed above 12 mph (20 km/h).                      If the display message disappears, the functions mentioned above are available again.</li> </ul> <p>If the multifunction display still shows the display message:</p> <ul style="list-style-type: none"> <li>► Drive on carefully.</li> <li>► Visit a qualified specialist workshop.</li> </ul>

**Display messages**

Inoperative See  
Operator's Manual

**Possible causes/consequences and ► Solutions**

ESP®, ESP® trailer stabilization, BAS, PRE-SAFE®, the HOLD function, hill start assist, Crosswind Assist, STEER CONTROL, Active Lane Keeping Assist and Active Blind Spot Assist are unavailable due to a malfunction.

COLLISION PREVENTION ASSIST, BAS PLUS and PRE-SAFE® Brake may also have failed.

In addition, the  and  warning lamps light up in the instrument cluster.

ATTENTION ASSIST is deactivated.

 **WARNING**

The brake system continues to function normally, but without the functions listed above. The wheels could therefore lock if you brake hard, for example.

The braking distance in an emergency braking situation can thus increase.

If ESP® is not operational, ESP® is unable to stabilize the vehicle. There is an increased risk of skidding and an accident.

- Drive on carefully.
- Visit a qualified specialist workshop.



Inoperative See  
Operator's Manual

EBD (electronic brake force distribution), ABS, ESP®, ESP® trailer stabilization, BAS, PRE-SAFE®, the HOLD function, hill start assist, Crosswind Assist, STEER CONTROL, Active Lane Keeping Assist and Active Blind Spot Assist are unavailable due to a malfunction. COLLISION PREVENTION ASSIST, BAS PLUS and PRE-SAFE® Brake may also have failed.

In addition, the ,  and  warning lamps light up in the instrument cluster and a warning tone sounds.

ATTENTION ASSIST is deactivated.











 **WARNING**









The brake system continues to function normally, but without the functions listed above. The wheels could therefore lock if you brake hard, for example.

The steerability and braking characteristics may be severely affected. The braking distance in an emergency braking situation can increase.

If ESP® is not operational, ESP® is unable to stabilize the vehicle. There is an increased risk of skidding and an accident.

- Drive on carefully.
- Visit a qualified specialist workshop immediately.

Display messages	Possible causes/consequences and ► Solutions
<p> (USA only)  (Canada only) Check brake fluid level</p>	<p>There is not enough brake fluid in the brake fluid reservoir. In addition, the  (USA only) or  (Canada only) warning lamp lights up in the instrument cluster and a warning tone sounds.</p> <p> <b>WARNING</b></p> <p>The braking effect may be impaired. There is a risk of an accident.</p> <ul style="list-style-type: none"> <li>► Pull over and stop the vehicle safely as soon as possible, paying attention to road and traffic conditions. Do not continue driving under any circumstances.</li> <li>► Secure the vehicle against rolling away (► page 148).</li> <li>► Consult a qualified specialist workshop.</li> <li>► Do not add brake fluid. This does not correct the malfunction.</li> </ul>
<p> Restraint sys. malfunction Consult workshop</p>	<p>The restraint system is faulty. The  warning lamp also lights up in the instrument cluster.</p> <p> <b>WARNING</b></p> <p>The air bags or Emergency Tensioning Devices may either be triggered unintentionally or, in the event of an accident, may not be triggered. There is an increased risk of injury.</p> <ul style="list-style-type: none"> <li>► Visit a qualified specialist workshop.</li> </ul> <p>Observe the additional information on restraint systems (► page 50).</p>
<p> Front left malfunction Consult workshop or Front right malfunction Consult workshop</p>	<p>The restraint system has malfunctioned at the front on the left or right. The  warning lamp also lights up in the instrument cluster.</p> <p> <b>WARNING</b></p> <p>The air bags or Emergency Tensioning Devices may either be triggered unintentionally or, in the event of an accident, may not be triggered. There is an increased risk of injury.</p> <ul style="list-style-type: none"> <li>► Visit a qualified specialist workshop.</li> </ul>

Display messages	Possible causes/consequences and ► Solutions
 <p>Rear left malfunction Consult workshop or Rear right malfunction Consult workshop</p>	<p>The restraint system has malfunctioned at the rear on the left or right. The  warning lamp also lights up in the instrument cluster.</p> <p> <b>WARNING</b></p> <p>The air bags or Emergency Tensioning Devices may either be triggered unintentionally or, in the event of an accident, may not be triggered.</p> <p>There is an increased risk of injury.</p> <p>► Visit a qualified specialist workshop.</p>
 <p>Rear Center Malfunction Service Required</p>	<p>The restraint system has malfunctioned at the rear center. The  warning lamp also lights up in the instrument cluster.</p> <p> <b>WARNING</b></p> <p>The air bags or Emergency Tensioning Devices may either be triggered unintentionally or, in the event of an accident, may not be triggered.</p> <p>There is an increased risk of injury.</p> <p>► Visit a qualified specialist workshop.</p>
 <p>Left Side Curtain Airbag Malfunction Service Required or Right Side Curtain Airbag Malfunction Service Required</p>	<p>There is a malfunction in the left-hand or right-hand window curtain air bag. The  warning lamp also lights up in the instrument cluster.</p> <p> <b>WARNING</b></p> <p>The left or right window curtain air bag may either be triggered unintentionally or, in the event of an accident, may not be triggered.</p> <p>There is an increased risk of injury.</p> <p>► Visit a qualified specialist workshop.</p>



Display messages	Possible causes/consequences and ► Solutions
<p>Front Passenger Airbag Disabled See Operator's Manual See Operator's Manual</p>	<p>The front-passenger air bag is deactivated during the journey, even though:</p> <ul style="list-style-type: none"> <li>• an adult</li> <li>or</li> <li>• a person of the corresponding stature is on the front-passenger seat</li> </ul> <p>If additional forces are applied to the seat, the system may interpret the occupant's weight as lower than it actually is.</p> <p><b>⚠ WARNING</b></p> <p>The front-passenger air bag does not deploy during an accident. There is an increased risk of injury.</p> <ul style="list-style-type: none"> <li>► Pull over and stop the vehicle safely as soon as possible, paying attention to road and traffic conditions.</li> <li>► Secure the vehicle against rolling away (► page 148).</li> <li>► Switch the ignition off.</li> <li>► Have the occupant get out of the vehicle.</li> <li>► Keep the seat unoccupied, close the front-passenger door and switch on the ignition.</li> <li>► Observe the PASSENGER AIR BAG OFF indicator lamp in the center console and the multifunction display and check the following:</li> </ul> <p>Seat unoccupied and ignition switched on:</p> <ul style="list-style-type: none"> <li>• the PASSENGER AIR BAG OFF indicator lamp must then light up and remain lit. If the indicator lamp is on, OCS has disabled the front-passenger front air bag (► page 60)</li> <li>• the <a href="#">Front Passenger Airbag Disabled See Operator's Manual</a> or <a href="#">Front Passenger Airbag Disabled See Operator's Manual</a> display messages must not be shown in the multifunction display</li> </ul> <ul style="list-style-type: none"> <li>► Wait for a period of at least 60 seconds until the necessary system checks have been completed.</li> <li>► Make sure that the display messages do not appear in the multifunction display.</li> </ul> <p>If these conditions are fulfilled, the front-passenger seat can be occupied again. Whether the PASSENGER AIR BAG OFF indicator lamp remains lit or goes out depends on how OCS classifies the occupant.</p> <p>If the conditions are not fulfilled, the system is not operating correctly.</p> <ul style="list-style-type: none"> <li>► Visit a qualified specialist workshop immediately.</li> </ul>

**Display messages**

Front Passenger Airbag Enabled See Operator's Manual  
See Operator's Manual

**Possible causes/consequences and ► Solutions**

The front-passenger air bag is enabled during the journey, even though:

- a child, a small adult or an object weighing less than the system's weight threshold is located on the front-passenger seat or
- the front-passenger seat is unoccupied

The system may detect objects or forces applying additional weight on the seat.

 **WARNING**

The air bag may deploy unintentionally.

There is an increased risk of injury.

- Pull over and stop the vehicle safely as soon as possible, paying attention to road and traffic conditions.
- Secure the vehicle against rolling away (▷ page 148).
- Switch the ignition off.
- Open the front-passenger door.
- Remove the child and the child restraint system from the front-passenger seat.
- Make sure that there are no objects on the seat adding to the weight.

The system may otherwise detect the additional weight and interpret the seat occupant's weight as greater than it actually is.



- Keep the seat unoccupied, close the front-passenger door and switch on the ignition.
- Observe the PASSENGER AIR BAG OFF indicator lamp in the center console and the multifunction display and check the following:

Seat unoccupied and ignition switched on:

- The PASSENGER AIR BAG OFF indicator lamp must then light up and remain lit. If the indicator lamp is on, OCS (Occupant Classification System) has disabled the front-passenger air bag (▷ page 60)
- The [Front Passenger Airbag Enabled See Operator's Manual](#) or [Front Passenger Airbag Disabled See Operator's Manual](#) display messages must not be shown in the multifunction display
- Wait for a period of at least 60 seconds until the necessary system checks have been completed.
- Make sure that the display messages do not appear in the multifunction display.

Display messages	Possible causes/consequences and ► Solutions
	<p>If these conditions are fulfilled, the front-passenger seat can be occupied again. Whether the PASSENGER AIR BAG OFF indicator lamp remains lit or goes out depends on how OCS classifies the occupant.</p> <p>If the conditions are not fulfilled, the system is not operating correctly.</p> <ul style="list-style-type: none"> <li>► Visit a qualified specialist workshop immediately.</li> </ul>

**Engine**

Display messages	Possible causes/consequences and ► Solutions
 <p>Coolant Too Hot Stop Vehicle Turn Engine Off</p>	<p>The coolant is too hot. A warning tone also sounds.</p> <p> <b>WARNING</b></p> <p>Do not drive when your engine is overheated. This can cause some fluids which may have leaked into the engine compartment to catch fire.</p> <p>Steam from the overheated engine can also cause serious burns which can occur just by opening the hood.</p> <p>There is a risk of injury.</p> <ul style="list-style-type: none"> <li>► Pull over and stop the vehicle safely and switch off the engine, paying attention to road and traffic conditions.</li> <li>► Secure the vehicle against rolling away (► page 148).</li> <li>► Wait until the engine has cooled down.</li> <li>► Make sure that the air supply to the engine radiator is not blocked, e.g. by snow, slush or ice.</li> <li>► Do not start the engine again until the display message goes out and the coolant temperature is below 248 °F (120 °C). Otherwise, the engine could be damaged.</li> <li>► Pay attention to the coolant temperature display.</li> <li>► If the temperature increases again, visit a qualified specialist workshop immediately.</li> </ul> <p>Under normal operating conditions and with the specified coolant level, the coolant temperature may rise to 248 °F (120 °C).</p>

## Driving systems

## Display messages



Max. speed 12 mph

## Possible causes/consequences and ► Solutions

You are exceeding the speed permissible for the selected off-road level.

In addition, the vehicle level display appears between the vehicle icon and the display message, and a warning tone sounds.

 **WARNING**

The vehicle could tip and rollover.

There is a risk of an accident.

- Adjust your driving style to the altered handling characteristics.
- Only make slight steering movements and avoid fast steering movements.
- Do not exceed 12 mph (20 km/h) until the vehicle has reached off-road level 2.



ACTIVE CURVE SYSTEM Malfunction  
See Operator's Manual

The Active Curve System is faulty. The vehicle's handling characteristics are severely impaired. A warning tone also sounds.







 **WARNING**

There is a risk of an accident.

- Drive on carefully.
- Adjust your driving style to the altered handling characteristics.
- Avoid sudden acceleration around tight corners and fast steering movements.
- Do not drive at speeds above 50 mph (80 km/h).
- Visit a qualified specialist workshop immediately.

Tires	
Display messages	Possible causes/consequences and ► Solutions
Check Tire Pressure Soon	<p>The tire pressure loss warning system has detected a significant loss in pressure. A warning tone also sounds. Possible causes:</p> <ul style="list-style-type: none"> <li>• you have changed the positions of the wheels and tires or installed new wheels and tires.</li> <li>• the tire pressure in one or more tires is not correct.</li> </ul> <p> <b>WARNING</b></p> <p>Tire pressures that are too low pose the following hazards:</p> <ul style="list-style-type: none"> <li>• they may burst, especially as the load and vehicle speed increase.</li> <li>• they may wear excessively and/or unevenly, which may greatly impair tire traction.</li> <li>• the driving characteristics, as well as steering and braking, may be greatly impaired.</li> </ul> <p>There is a risk of an accident.</p> <ul style="list-style-type: none"> <li>► Stop the vehicle without making any sudden steering or braking maneuvers. Pay attention to the traffic conditions as you do so.</li> <li>► Secure the vehicle against rolling away (▷ page 148).</li> <li>► Check the tires and, if necessary, follow the instructions for a flat tire (▷ page 275).</li> <li>► Check the tire pressures and, if necessary, correct the tire pressure.</li> <li>► Restart the tire pressure loss warning system when the tire pressure is correct (▷ page 299).</li> </ul>
Check Tires	<p>The tire pressure in one or more tires has dropped significantly. The wheel position is displayed in the multifunction display. A warning tone also sounds.</p> <p> <b>WARNING</b></p> <p>Tire pressures that are too low pose the following hazards:</p> <ul style="list-style-type: none"> <li>• they may burst, especially as the load and vehicle speed increase.</li> <li>• they may wear excessively and/or unevenly, which may greatly impair tire traction.</li> <li>• the driving characteristics, as well as steering and braking, may be greatly impaired.</li> </ul> <p>There is a risk of an accident.</p>

Display messages	Possible causes/consequences and ► Solutions
	<ul style="list-style-type: none"> <li>► Stop the vehicle without making any sudden steering or braking maneuvers. Pay attention to the traffic conditions as you do so.</li> <li>► Secure the vehicle against rolling away (▷ page 148).</li> <li>► Check the tires and, if necessary, follow the instructions for a flat tire (▷ page 275).</li> <li>► Check the tire pressure (▷ page 300).</li> <li>► If necessary, correct the tire pressure.</li> </ul>
Warning Tire Malfunction	<p>The tire pressure in one or more tires has dropped suddenly. The wheel position is shown in the multifunction display.</p> <p> <b>WARNING</b></p> <p>Driving with a flat tire poses a risk of the following hazards:</p> <ul style="list-style-type: none"> <li>• a flat tire affects the ability to steer or brake the vehicle.</li> <li>• you could lose control of the vehicle.</li> <li>• continued driving with a flat tire will cause excessive heat build-up and possibly a fire.</li> </ul> <p>There is a risk of an accident.</p> <ul style="list-style-type: none"> <li>► Stop the vehicle without making any sudden steering or braking maneuvers. Pay attention to the traffic conditions as you do so.</li> <li>► Secure the vehicle against rolling away (▷ page 148).</li> <li>► Check the tires and, if necessary, follow the instructions for a flat tire (▷ page 275).</li> </ul>

Vehicle	
Display messages	Possible causes/consequences and ► Solutions
Risk of vehicle rolling Transmission not in P	<p>The driver's door is open/not completely closed and the transmission is in position <b>R</b>, <b>N</b> or <b>D</b>.</p> <p>A warning tone also sounds.</p> <p> <b>WARNING</b></p> <p>The vehicle may roll away. There is a risk of an accident.</p> <ul style="list-style-type: none"> <li>► Shift the transmission to position <b>P</b>.</li> <li>► Secure the vehicle against rolling away (▷ page 148).</li> <li>► Close the driver's door completely.</li> </ul>
	<p>The tailgate is open.</p> <p> <b>WARNING</b></p> <p>When the engine is running, exhaust gases can enter the vehicle interior if the tailgate is open. There is a risk of poisoning.</p> <ul style="list-style-type: none"> <li>► Close the tailgate.</li> </ul>
	<p>The hood is open.</p> <p> <b>WARNING</b></p> <p>The open hood may block your view when the vehicle is in motion. There is a risk of an accident.</p> <ul style="list-style-type: none"> <li>► Pull over and stop the vehicle safely as soon as possible, paying attention to road and traffic conditions.</li> <li>► Secure the vehicle against rolling away (▷ page 148).</li> <li>► Close the hood.</li> </ul>
 Power steering Mal- function See Oper- ator's Manual	<p>The power steering is malfunctioning. A warning tone also sounds.</p> <p> <b>WARNING</b></p> <p>You will need to use more force to steer. There is a risk of an accident.</p> <ul style="list-style-type: none"> <li>► Check whether you are able to apply the extra force required.</li> <li>► <b>If you are able to steer safely:</b> carefully drive on to a qualified specialist workshop.</li> <li>► <b>If you are unable to steer safely:</b> do not drive on. Contact the nearest qualified specialist workshop.</li> </ul>



## Warning and indicator lamps in the instrument cluster



## General notes

This section describes indicator and warning lamps in the instrument cluster relevant to safety and solutions. A description of other indicator and warning lamps in the instrument cluster and their solutions can be found in the Digital Operator's Manual.

Some systems carry out a self-diagnosis when the ignition is switched on. Therefore, some indicator and warning lamps may light up or flash temporarily. This behavior is non-critical. These indicator and warning lamps only indicate a malfunction if they light up or flash after starting the engine or whilst driving.



## Safety





## Seat belts





Problem	Possible causes/consequences and ► Solutions
 <p>After starting the engine, the red seat belt warning lamp lights up. In addition, a warning tone sounds for up to 6 seconds.</p>	<p>The driver's seat belt is not fastened.</p> <ul style="list-style-type: none"> <li>► Fasten your seat belt (▷ page 54).</li> </ul> <p>The warning tone ceases.</p>
 <p>The red seat belt warning lamp lights up after the engine starts, as soon as the driver's or the front-passenger door is closed.</p>	<p>The driver or front passenger has not fastened their seat belt.</p> <ul style="list-style-type: none"> <li>► Fasten your seat belt (▷ page 54).</li> </ul> <p>The warning lamp goes out.</p>
	<p>There are objects on the front-passenger seat.</p> <ul style="list-style-type: none"> <li>► Remove the objects from the front-passenger seat and stow them in a secure place.</li> </ul> <p>The warning lamp goes out.</p>





Problem	Possible causes/consequences and ► Solutions
 <p>The red seat belt warning lamp flashes and an intermittent audible warning sounds.</p>	<p>The driver or front passenger has not fastened their seat belt. The vehicle is being driven faster than 15 mph (25 km/h) or has briefly been driven faster than 15 mph (25 km/h).</p> <ul style="list-style-type: none"><li>► Fasten your seat belt (► page 54). The warning lamp goes out and the intermittent warning tone ceases.</li></ul> <p>There are objects on the front-passenger seat. The vehicle is being driven faster than 15 mph (25 km/h) or has briefly been driven faster than 15 mph (25 km/h).</p> <ul style="list-style-type: none"><li>► Remove the objects from the front-passenger seat and stow them in a secure place. The warning lamp goes out and the intermittent warning tone ceases.</li></ul>







## Safety systems

Problem	Possible causes/consequences and ► Solutions
<p> (USA only)</p> <p>The red brake system warning lamp comes on while the engine is running.</p> <p>A warning tone also sounds.</p>	<p> <b>WARNING</b></p> <p>The brake boosting effect is malfunctioning and the braking characteristics may be affected.</p> <p>There is a risk of an accident.</p> <ul style="list-style-type: none"> <li>► Pull over and stop the vehicle safely as soon as possible, paying attention to road and traffic conditions. Do not continue driving under any circumstances.</li> <li>► Secure the vehicle against rolling away (► page 148).</li> <li>► Consult a qualified specialist workshop.</li> <li>► Observe the additional display messages in the multifunction display.</li> </ul>
	<p>There is not enough brake fluid in the brake fluid reservoir.</p> <p> <b>WARNING</b></p> <p>The braking effect may be impaired.</p> <p>There is a risk of an accident.</p> <ul style="list-style-type: none"> <li>► Pull over and stop the vehicle safely as soon as possible, paying attention to road and traffic conditions. Do not continue driving under any circumstances.</li> <li>► Secure the vehicle against rolling away (► page 148).</li> <li>► Do not add brake fluid. Adding more will not remedy the malfunction.</li> <li>► Consult a qualified specialist workshop.</li> <li>► Observe the additional display messages in the multifunction display.</li> </ul>





Problem	Possible causes/consequences and ► Solutions
 <p>The yellow ABS warning lamp is lit while the engine is running.</p>	<p>ABS (Anti-lock Braking System) is deactivated due to a malfunction. Therefore, BAS (Brake Assist), BAS PLUS, COLLISION PREVENTION ASSIST, ESP® (Electronic Stability Program), ESP® trailer stabilization, PRE-SAFE®, PRE-SAFE® Brake, HOLD function, hill start assist, Crosswind Assist, STEER CONTROL, Active Lane Keeping Assist and Active Blind Spot Assist are also deactivated. In addition, the  and  warning lamps may light up in the instrument cluster.</p> <p>ATTENTION ASSIST is deactivated.</p> <p> <b>WARNING</b></p> <p>The brake system continues to function normally, but without the functions listed above. The wheels could therefore lock if you brake hard, for example.</p> <p>The steerability and braking characteristics may be severely affected. The braking distance in an emergency braking situation can increase.</p> <p>If ESP® is not operational, ESP® is unable to stabilize the vehicle. There is an increased risk of skidding and an accident.</p> <ul style="list-style-type: none"> <li>► Observe the additional display messages in the multifunction display.</li> <li>► Drive on carefully.</li> <li>► Visit a qualified specialist workshop.</li> </ul> <p>If the ABS control unit is faulty, there is also a possibility that other systems, such as the navigation system or the automatic transmission, will not be available.</p>





Problem	Possible causes/consequences and ► Solutions
 <p>The yellow ABS warning lamp is lit while the engine is running.</p>	<p>ABS is temporarily unavailable. Therefore, BAS, BAS PLUS, COLLISION PREVENTION ASSIST, ESP<sup>®</sup>, ESP<sup>®</sup> trailer stabilization, EBD (electronic brake force distribution), PRE-SAFE<sup>®</sup>, PRE-SAFE<sup>®</sup> Brake, the HOLD function, hill start assist, Crosswind Assist, STEER CONTROL, Active Lane Keeping Assist and Active Blind Spot Assist, for example, are also deactivated.</p> <p>In addition, the  and  warning lamps may light up in the instrument cluster.</p> <p>ATTENTION ASSIST is deactivated.</p> <p>Possible causes are:</p> <ul style="list-style-type: none"> <li>• Self-diagnosis is not yet complete.</li> <li>• the on-board voltage may be insufficient.</li> </ul> <p> <b>WARNING</b></p> <p>The brake system continues to function normally, but without the functions listed above. The front and rear wheels could therefore lock if you brake hard, for example.</p> <p>The steerability and braking characteristics may be severely affected. The braking distance in an emergency braking situation can increase.</p> <p>If ESP<sup>®</sup> is not operational, ESP<sup>®</sup> is unable to stabilize the vehicle. There is a risk of an accident.</p> <ul style="list-style-type: none"> <li>► Carefully drive a suitable distance, making slight steering movements at a speed above 12 mph (20 km/h). The functions mentioned above are available again when the warning lamp goes out.</li> </ul> <p>If the warning lamp is still on:</p> <ul style="list-style-type: none"> <li>► Observe the additional display messages in the multifunction display.</li> <li>► Drive on carefully.</li> <li>► Visit a qualified specialist workshop.</li> </ul>

Problem	Possible causes/consequences and ► Solutions
<p> The yellow ABS warning lamp is lit while the engine is running. A warning tone also sounds.</p>	<p>EBD is not available due to a malfunction. Therefore ABS, BAS, BAS PLUS, ESP<sup>®</sup>, ESP<sup>®</sup> trailer stabilization, PRE-SAFE<sup>®</sup>, PRE-SAFE<sup>®</sup> Brake, COLLISION PREVENTION ASSIST, HOLD function, hill start assist, Crosswind Assist, STEER CONTROL, Active Lane Keeping Assist and Active Blind Spot Assist are also unavailable.</p> <p>In addition, the  and  warning lamps may light up in the instrument cluster.</p> <p>ATTENTION ASSIST is deactivated.</p> <p> <b>WARNING</b></p> <p>The brake system continues to function normally, but without the functions listed above. The front and rear wheels could therefore lock if you brake hard, for example.</p> <p>The steerability and braking characteristics may be severely affected. The braking distance in an emergency braking situation can increase.</p> <p>If ESP<sup>®</sup> is not operational, ESP<sup>®</sup> is unable to stabilize the vehicle. There is an increased risk of skidding and an accident.</p> <ul style="list-style-type: none"> <li>► Observe the additional display messages in the multifunction display.</li> <li>► Drive on carefully.</li> <li>► Visit a qualified specialist workshop.</li> </ul>



Problem	Possible causes/consequences and ► Solutions
<p data-bbox="185 275 350 301"> (USA only)</p> <p data-bbox="185 310 352 335">  </p> <p data-bbox="181 344 418 551">The red brake warning lamp, the yellow ESP<sup>®</sup> and ESP<sup>®</sup> OFF warning lamp and the yellow ABS warning lamp are lit while the engine is running.</p>	<p data-bbox="439 275 1092 462">ABS and ESP<sup>®</sup> are malfunctioning. Therefore BAS, BAS PLUS, COLLISION PREVENTION ASSIST, ESP<sup>®</sup> trailer stabilization, PRE-SAFE<sup>®</sup>, PRE-SAFE<sup>®</sup> Brake, HOLD function, hill start assist, Crosswind Assist, STEER CONTROL, Active Lane Keeping Assist and Active Blind Spot Assist are also unavailable. ATTENTION ASSIST is deactivated.</p> <p data-bbox="452 480 602 505"> <b>WARNING</b></p> <p data-bbox="439 523 1102 605">The brake system continues to function normally, but without the functions listed above. The front and rear wheels could therefore lock if you brake hard, for example.</p> <p data-bbox="439 614 1102 697">The steerability and braking characteristics may be severely affected. The braking distance in an emergency braking situation can increase.</p> <p data-bbox="439 706 1102 770">If ESP<sup>®</sup> is not operational, ESP<sup>®</sup> is unable to stabilize the vehicle. There is an increased risk of skidding and an accident.</p> <ul style="list-style-type: none"> <li data-bbox="439 779 1087 838">► Observe the additional display messages in the multifunction display.</li> <li data-bbox="439 847 647 872">► Drive on carefully.</li> <li data-bbox="439 881 834 906">► Visit a qualified specialist workshop.</li> </ul>
<p data-bbox="185 942 234 967"></p> <p data-bbox="181 976 418 1059">The yellow ESP<sup>®</sup> warning lamp flashes while the vehicle is in motion.</p>	<p data-bbox="439 942 1102 1025">ESP<sup>®</sup> or traction control has intervened because there is a risk of skidding or at least one wheel has started to spin. Cruise control or DISTRONIC PLUS is deactivated.</p> <ul style="list-style-type: none"> <li data-bbox="439 1042 1102 1102">► When pulling away, only depress the accelerator pedal as far as necessary.</li> <li data-bbox="439 1111 1076 1136">► Ease off the accelerator pedal while the vehicle is in motion.</li> <li data-bbox="439 1145 1102 1170">► Adapt your driving style to suit the road and weather conditions.</li> <li data-bbox="439 1179 713 1204">► Do not deactivate ESP<sup>®</sup>.</li> </ul> <p data-bbox="463 1213 1087 1277">In rare cases (► page 80), it may be best to deactivate ESP<sup>®</sup>. Observe the important safety notes on ESP<sup>®</sup> (► page 79).</p>



Problem	Possible causes/consequences and ► Solutions
 <p>The yellow ESP® OFF warning lamp is lit while the engine is running.</p>	<p>ESP® is deactivated.</p> <p> <b>WARNING</b></p> <p>If ESP® is switched off, ESP® is unable to stabilize the vehicle. Further driving systems or driving safety systems are thus restricted, e.g. Active Blind Spot Assist. The system does not perform course-correcting brake applications.</p> <p>There is an increased risk of skidding and an accident.</p> <ul style="list-style-type: none"> <li>► Reactivate ESP®. <ul style="list-style-type: none"> <li>In rare cases (► page 80), it may be best to deactivate ESP®. Observe the important safety notes on ESP® (► page 79).</li> </ul> </li> <li>► Adapt your driving style to suit the road and weather conditions.</li> </ul> <p>If ESP® cannot be activated:</p> <ul style="list-style-type: none"> <li>► Have ESP® checked at a qualified specialist workshop.</li> </ul>
 <p>The yellow ESP® and ESP® OFF warning lamps are lit while the engine is running.</p>	<p>ESP®, BAS, BAS PLUS, COLLISION PREVENTION ASSIST, ESP® trailer stabilization, PRE-SAFE®, PRE-SAFE® Brake, the HOLD function, hill start assist, Crosswind Assist, STEER CONTROL, Active Lane Keeping Assist and Active Blind Spot Assist are not available due to a malfunction.</p> <p>ATTENTION ASSIST is deactivated.</p> <p> <b>WARNING</b></p> <p>The brake system continues to function normally, but without the functions listed above.</p> <p>The braking distance in an emergency braking situation can thus increase.</p> <p>If ESP® is not operational, ESP® is unable to stabilize the vehicle. There is an increased risk of skidding and an accident.</p> <ul style="list-style-type: none"> <li>► Observe the additional display messages in the multifunction display.</li> <li>► Drive on carefully.</li> <li>► Visit a qualified specialist workshop.</li> </ul>





Problem	Possible causes/consequences and ► Solutions
 <p>The yellow ESP<sup>®</sup> and ESP<sup>®</sup> OFF warning lamps are lit while the engine is running.</p>	<p>ESP<sup>®</sup>, BAS, PRE-SAFE<sup>®</sup>, the HOLD function, hill start assist, Crosswind Assist and ESP<sup>®</sup> trailer stabilization are temporarily unavailable.</p> <p>COLLISION PREVENTION ASSIST, BAS PLUS and PRE-SAFE<sup>®</sup> Brake may also have failed.</p> <p>ATTENTION ASSIST is deactivated.</p> <p>Self-diagnosis is not yet complete.</p> <p> <b>WARNING</b></p> <p>The brake system continues to function normally, but without the functions listed above.</p> <p>The braking distance in an emergency braking situation can thus increase.</p> <p>If ESP<sup>®</sup> is not operational, ESP<sup>®</sup> is unable to stabilize the vehicle. There is an increased risk of skidding and an accident.</p> <ul style="list-style-type: none"> <li>► Carefully drive a suitable distance, making slight steering movements at a speed above 12 mph (20 km/h). The functions mentioned above are available again when the warning lamp goes out.</li> </ul> <p>If the warning lamp is still on:</p> <ul style="list-style-type: none"> <li>► Observe the additional display messages in the multifunction display.</li> <li>► Drive on carefully.</li> <li>► Visit a qualified specialist workshop.</li> </ul>
 <p>The red restraint system warning lamp is lit while the engine is running.</p>	<p>The restraint system is faulty.</p> <p> <b>WARNING</b></p> <p>The air bags or Emergency Tensioning Devices may either be triggered unintentionally or, in the event of an accident, may not be triggered.</p> <p>There is an increased risk of injury.</p> <ul style="list-style-type: none"> <li>► Observe the additional display messages in the multifunction display.</li> <li>► Drive on carefully.</li> <li>► Have the restraint system checked immediately at a qualified specialist workshop.</li> </ul> <p>For further information about the restraint system, see (► page 50).</p>

## Engine

Problem	Possible causes/consequences and ► Solutions
 <p>The red coolant warning lamp comes on while the engine is running. A warning tone also sounds.</p>	<p>The coolant temperature has exceeded 248 °F (120 °C). The air-flow to the engine radiator may be blocked or the coolant level may be too low.</p> <p> <b>WARNING</b></p> <p>The engine is not being cooled sufficiently and may be damaged. Do not drive when your engine is overheated. This can cause some fluids which may have leaked into the engine compartment to catch fire.</p> <p>Steam from the overheated engine can also cause serious burns which can occur just by opening the hood.</p> <p>There is a risk of injury.</p> <ul style="list-style-type: none"> <li>► Observe the additional display messages in the multifunction display.</li> <li>► Pull over and stop the vehicle safely and switch off the engine, paying attention to road and traffic conditions.</li> <li>► Secure the vehicle against rolling away (► page 148).</li> <li>► Leave the vehicle and keep a safe distance from the vehicle until the engine has cooled down.</li> <li>► Check the coolant level and add coolant, observing the warning notes (► page 269).</li> <li>► If you have to add coolant frequently, have the engine cooling system checked.</li> <li>► Make sure that the air supply to the engine radiator is not blocked, e.g. by snow, slush or ice.</li> <li>► At coolant temperatures below 248 °F (120 °C), drive to the nearest qualified specialist workshop.</li> <li>► Avoid subjecting the engine to heavy loads, e.g. driving in mountainous terrain, and stop-and-go traffic.</li> </ul>

## Driving systems

Problem	Possible causes/consequences and ► Solutions
 <p>The red distance warning function warning lamp comes on while the vehicle is moving. A warning tone also sounds.</p>	<p>You are approaching a vehicle or a stationary obstacle in your line of travel at too high a speed.</p> <ul style="list-style-type: none"> <li>► Be prepared to brake immediately.</li> <li>► Pay careful attention to the traffic situation. You may have to brake or take evasive action.</li> </ul> <p>Observe the additional information on DISTRONIC PLUS (▷ page 156).</p> <p>Observe the additional information on PRE-SAFE® Brake (▷ page 82).</p> <p>Observe the additional information on the distance warning function of COLLISION PREVENTION ASSIST (▷ page 76).</p>

Tires	
Problem	Possible causes/consequences and ► Solutions
 The yellow tire pressure monitor warning lamp (pressure loss/malfunction) is lit.	<p>The tire pressure monitor has detected a loss of pressure in at least one of the tires.</p> <p> <b>WARNING</b></p> <p>With tire pressures which are too low, there is a risk of the following hazards:</p> <ul style="list-style-type: none"> <li>• they may burst, especially as the load and vehicle speed increase.</li> <li>• they may wear excessively and/or unevenly, which may greatly impair tire traction.</li> <li>• the driving characteristics, as well as steering and braking, may be greatly impaired.</li> </ul> <p>There is a risk of an accident.</p> <ul style="list-style-type: none"> <li>► Stop the vehicle without making any sudden steering or braking maneuvers. Pay attention to the traffic conditions as you do so.</li> <li>► Secure the vehicle against rolling away (▷ page 148).</li> <li>► Observe the additional display messages in the multifunction display.</li> <li>► Check the tires and, if necessary, follow the instructions for a flat tire (▷ page 275).</li> <li>► Check the tire pressure (▷ page 300).</li> <li>► If necessary, correct the tire pressure.</li> </ul>
 The yellow tire pressure monitor warning lamp (pressure loss/malfunction) flashes for approximately one minute and then remains lit.	<p>The tire pressure monitor is faulty.</p> <p> <b>WARNING</b></p> <p>The system is possibly unable to recognize or register low tire pressure.</p> <p>There is a risk of an accident.</p> <ul style="list-style-type: none"> <li>► Observe the additional display messages in the multifunction display.</li> <li>► Visit a qualified specialist workshop.</li> </ul>



Useful information .....	228
General notes .....	228
Important safety notes .....	228
Declarations of conformity .....	229
Information on copyright .....	229
Function restrictions .....	230
COMAND operating system .....	230
Online and Internet functions .....	236



### Useful information

- i** These operating instructions describe all the standard and optional equipment of your COMAND system, as available at the time of going to print. Country-specific differences are possible. Please note that your COMAND system may not be equipped with all the features described. This also applies to safety-related systems and functions.
- i** Read the information on qualified specialist workshops: (▷ page 35).

### General notes

The Audio 20/COMAND section in these operating instructions describes the basic operating principles. More information can be found in the Digital Operator's Manual.

The COMAND section in these operating instructions describes the basic principles for operation. More information can be found in the Digital Operator's Manual.

The COMAND section in these operating instructions describes the basic principles for operating your COMAND. More information can be found in the Digital Operator's Manual.

### Important safety notes

#### WARNING

Modifications to electronic components, their software as well as wiring can impair their function and/or the function of other networked components. In particular, systems relevant to safety could also be affected. As a result, these may no longer function as intended and/or jeopardize the operating safety of the vehicle. There is an increased risk of an accident and injury.

Never tamper with the wiring as well as electronic components or their software. You should have all work to electrical and elec-

tronic equipment carried out at a qualified specialist workshop.

If you make any changes to the vehicle electronics, the general operating permit is rendered invalid.

#### WARNING

If you operate information systems and communication equipment integrated in the vehicle while driving, you will be distracted from traffic conditions. You could also lose control of the vehicle. There is a risk of an accident. Only operate the equipment when the traffic situation permits. If you are not sure that this is possible, park the vehicle paying attention to traffic conditions and operate the equipment when the vehicle is stationary.

You must observe the legal requirements for the country in which you are currently driving when operating COMAND.

COMAND calculates the route to the destination without taking account of the following, for example:

- traffic lights
- stop and yield signs
- merging lanes
- parking or stopping in a no parking/no stopping zone
- other road and traffic rules and regulations
- narrow bridges

COMAND can give incorrect navigation commands if the actual street/traffic situation does not correspond with the digital map's data. Digital maps do not cover all areas nor all routes in an area. For example, a route may have been diverted or the direction of a one-way street may have changed.

For this reason, you must always observe road and traffic rules and regulations during your journey. Road and traffic rules and regulations always have priority over the system's driving recommendations.

Navigation announcements are intended to direct you while driving without diverting your attention from the road and driving.

Please always use this feature instead of consulting the map display for directions. Looking at the icons or map display can distract you from traffic conditions and driving, and increase the risk of an accident.

Bear in mind that at a speed of only 30 mph (approximately 50 km/h) your vehicle covers a distance of 44 feet (approximately 14 m) per second.

This equipment complies with FCC radiation exposure limits set forth for uncontrolled equipment and meets the FCC radio frequency (RF) Exposure Guidelines in Supplement C to OET65.

This equipment has very low levels of RF energy that is deemed to comply without maximum permissive exposure evaluation (MPE). But it is desirable that it should be installed and operated with at least 8 inches (20 cm) and more between the radiator and a person's body (excluding extremities: hands, wrists, feet and legs.)

### Declarations of conformity

#### Vehicle components which receive and/or transmit radio waves

**i USA only:** The wireless devices of this vehicle comply with Part 15 of the FCC Rules. Operation is subject to the following two conditions:

- 1) These devices may not cause interference, and
- 2) These devices must accept any interference, including interference that may cause undesired operation of the device. Changes or modifications not expressly approved by the party responsible for compliance could void the user's authority to operate the equipment.

**i Canada only:** The wireless devices of this vehicle comply with Industry Canada

license-exempt RSS standard(s). Operation is subject to the following two conditions:

- 1) These devices may not cause interference, and
- 2) These devices must accept any interference, including interference that may cause undesired operation of the device.

### Information on copyright

#### General information

Information on licenses for free and Open Source software used in your vehicle and in the electronic components can be found on this website: <http://www.mercedes-benz.com/opensource>.

#### Registered trademarks

Registered trademarks:

- Bluetooth® is a registered trademark of Bluetooth® SIG Inc.
- DTS is a registered trademark of DTS, Inc.
- Dolby and MLP are registered trademarks of DOLBY Laboratories.
- BabySmart™, ESP® and PRE-SAFE® are registered trademarks of Daimler AG.
- HomeLink® is a registered trademark of Prince.
- iPod® and iTunes® are registered trademarks of Apple Inc.
- Logic7® is a registered trademark of Harman International Industries.
- Microsoft® and Windows media® are registered trademarks of Microsoft Corporation.
- SIRIUS is a registered trademark of Sirius XM Radio Inc.
- HD Radio is a registered trademark of iBiquity Digital Corporation.

- Gracenote® is a registered trademark of Gracenote, Inc.
- ZAGATSurvey® and related brands are registered trademarks of ZagatSurvey, LLC.

### Function restrictions

For safety reasons, some COMAND functions are restricted or unavailable while the vehicle is in motion. You will notice this, for example because either you will not be able to select certain menu items or COMAND will display a message to this effect.

- the online and Internet functions
- the Digital Operator's Manual

You can call up the main functions:

- using the corresponding buttons
- using the main function bar in the COMAND display
- using the remote control

## COMAND operating system

### Overview



- ① COMAND display (▷ page 231)
- ② COMAND control panel with a single DVD drive
- ③ COMAND controller (▷ page 235)

You can use COMAND to operate the following main functions:

- the navigation system
- the audio function
- the telephone function
- the video function
- the system settings

## COMAND display

## Display overview



Example display for radio

①	Status bar	Shows the time and the current settings for telephone operation.
②	Calls up the audio menu	Highlights the active Audio main function. The triangle indicates that this main function has a selectable submenu.
③	Main function bar	You can call up the desired main function from the main function bar. When the main function is activated, it is identifiable by the white lettering.
④	Display/selection window	Shows the content of the active Audio main function in radio mode.
⑤	Radio menu bar	Shows the other functions of the active Audio main function in radio mode.

## Menu overview

Navi	Audio	Telephone	Video	System	Symbol 
Route settings	FM/AM radio (using HD Radio™)	Telephone	Video DVD	Calls up the system menu	Calls up the Digital Operator's Manual
Map settings	Satellite radio	Address book	AUX		Calls up COMAND and Internet
Personal POIs	Disc				Calls up the weather service SIRIUS Weather
Messages (street name announcements, acoustic information during calls, audio fadeout, reserve fuel level)	Memory card				Calls up the Mercedes-Benz Mobile website
<input checked="" type="checkbox"/> Activates/deactivates alternative routes	MUSIC REGISTER				
Avoids an area	USB storage device				
SIRIUS service	Bluetooth Audio				
Map version	Media Interface				
	AUX				

## System menu overview

System	Time	SPLITVIEW	Consumption	Seat	Display off
Display settings	<input checked="" type="checkbox"/> Switches the automatic time settings on/off	Operates COMAND functions from the passenger side	Calls up the fuel consumption display	Changes the driver/front-passenger seat settings	Switches off the display
Text reader speed	Sets the time zone				
Voice-operated control settings	Switches to summer time				
Rear view camera	Manual time setting				
Language	Sets the time/date format				
Favorites button					
Activates/deactivates Bluetooth®					
Automatic volume adjustment					
Imports/exports data					
Resets COMAND					
<b>i</b> Delete your personal data using this function, for example before selling your vehicle.					

**If equipped with the rear view camera:** when the function is activated and COMAND is switched on, the image from the rear view camera is automatically shown in the COMAND display when reverse gear is engaged.

**i** If the **360° Camera** menu item is displayed, **Display Off** can be called up under **System**.



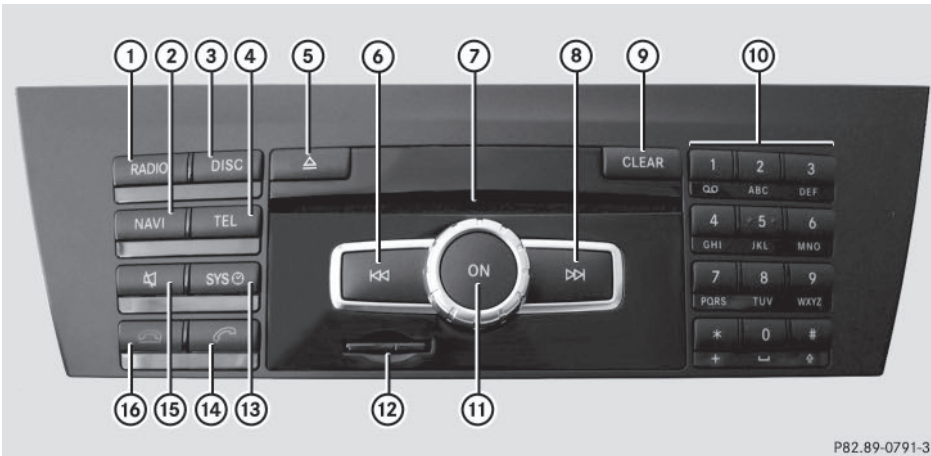









## COMAND control panel















P82.B9-0791-31

	Function	Page
①	Switches to radio mode Switches wavebands Switches to satellite radio	
②	Switches to navigation mode Shows the menu system	
③	Press <b>DISC</b> repeatedly: <ul style="list-style-type: none"> <li>Switches to audio CD and MP3 mode</li> <li>Switches to memory card mode</li> <li>Switches to MUSIC REGISTER</li> <li>Switches to USB storage device mode</li> <li>Switches to Media Interface or audio AUX mode</li> <li>Switches to Bluetooth® audio mode</li> </ul>	
④	Calls up the telephone basic menu: <ul style="list-style-type: none"> <li>Telephony via the Bluetooth® interface</li> </ul>	
⑤	Load/eject button	

	Function	Page
⑥	Selects stations via the station search function Rewinds Selects the previous track	
⑦	Disc slot <ul style="list-style-type: none"> <li>To insert CDs/DVDs</li> <li>To remove CDs/DVDs</li> <li>Updates the digital map</li> </ul>	
⑧	Selects stations via the station search function Fast forward Selects the next track	
⑨	Clear button <ul style="list-style-type: none"> <li>Deletes characters</li> <li>Deletes an entry</li> </ul>	

	Function	Page
⑩	Number pad <ul style="list-style-type: none"> <li>• Selects stations via the station presets</li> <li>• Stores stations manually</li> <li>• Mobile phone authorization</li> <li>• Telephone number entry</li> <li>• Sends DTMF tones</li> <li>• Character entry</li> <li>• Selects a location for the weather forecast from the memory</li> </ul> # Displays the current track being played * Selects stations by entering the frequency manually * Selects a track	         
⑪	Switches COMAND on/off Adjusts the volume	 

	Function	Page
⑫	SD memory card slot	
⑬	Calls up the system menu	
⑭	Accepts a call Dials a number Redial Accepts a waiting call	   
⑮	Switches the sound on or off Switches the microphone on/off Cancels the text message read-aloud function Switches off navigation announcements	   
⑯	Rejects a call Ends an active call Rejects a waiting call	  

**COMAND controller**

**Overview**



① COMAND controller

You can use the COMAND controller to select the menu items in the COMAND display.

You can:

- call up menus or lists
- scroll within menus or lists and
- exit menus or lists



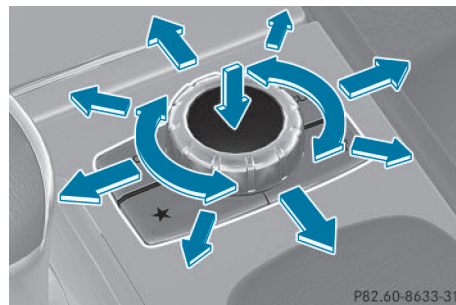

**Operation**



Example: operating the COMAND controller







The COMAND controller can be:

- pressed briefly or pressed and held 
- turned clockwise or counter-clockwise 
- slid left or right 
- slid forwards or backwards 
- slid diagonally 

### Example of operation

In the instructions, operating sequences are described as follows:

- ▶ Press the **RADIO** button.  
Radio mode is activated.
- ▶ Select **Radio** by sliding  and turning  the COMAND controller and press  to confirm.
- ▶ Confirm **Station List** by pressing . The station list appears.

## COMAND

### Buttons on the COMAND controller

#### Overview

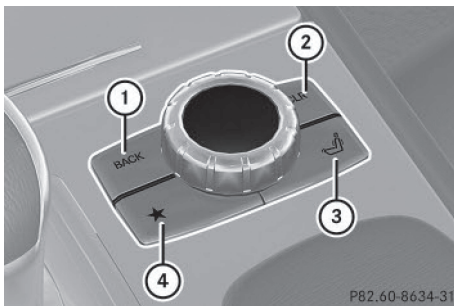

- 1 Back button (▷ page 236)
- 2 Clear button (▷ page 236)
- 3 Seat function button
- 4 Favorites button

If your vehicle does not have the seat function button, it will have two Favorites buttons. For AMG vehicles: the COMAND controller is configured with the ① and ② buttons.

### Back button

You can use the **BACK** button to exit a menu or to call up the basic display of the current operating mode.

- ▶ **To exit the menu:** briefly press the **BACK** back button.  
COMAND changes to the next higher menu level in the current operating mode.
- ▶ **To call up the basic display:** press and hold the **BACK** back button.  
COMAND changes to the basic display of the current operating mode.

### Clear button

- ▶ **To delete individual characters:** briefly press the **CLR** clear button.
- ▶ **To delete an entire entry:** press and hold the **CLR** clear button.

### Seat function button

You can use the  button to call up the following seat functions:

- Multicontour seat (with 4-way lumbar support)
- Active multicontour seat (dynamic seat and massage function)
- Balance (seat heating distribution)

### Favorites button

You can assign predefined functions to the  favorites button and call them up by pressing the button.

## Online and Internet functions

### Information in the Digital Operator's Manual

In the Digital Operator's Manual you will find information on the following topics:

- Online and Internet functions
- Google™ local search
- Destination/route download

- Weather display
- Internet

### General notes

#### Conditions for access

##### WARNING

If you operate information systems and communication equipment integrated in the vehicle while driving, you will be distracted from traffic conditions. You could also lose control of the vehicle. There is a risk of an accident. Only operate the equipment when the traffic situation permits. If you are not sure that this is possible, park the vehicle paying attention to traffic conditions and operate the equipment when the vehicle is stationary.

You must observe the legal requirements for the country in which you are currently driving when operating COMAND.



#### USA only:

To use COMAND Mercedes-Benz Apps and Internet access, the following conditions must be fulfilled:

- mbrace is activated and operational
- mbrace is activated for COMAND Mercedes-Benz Apps and Internet access

**Priority of connections:** an emergency call has the highest priority. When a service call, e.g. a breakdown service call or the MB Info Call, is active, an emergency call can still be initiated.

A service call, on the other hand, has priority over a current Internet connection. Therefore, you cannot establish an Internet connection during a service call.

-  The availability of individual COMAND Mercedes-Benz Apps may vary depending on the country.
-  The terms of use are shown when COMAND is used for the first time and then once a year thereafter. Only read and

accept the terms of use when the vehicle is stationary.





-  Internet pages cannot be shown on the driver's side while the vehicle is in motion.

#### Canada only:

The COMAND Mercedes-Benz Apps and the Internet access are available via the Bluetooth® interface.

In order to use the functions, the following conditions are necessary:

- The mobile phone supports the DUN Bluetooth® profile (**Dial-Up Networking**) and is connected to COMAND via the Bluetooth® interface. The DUN Bluetooth® profile enables the mobile phone to establish a dial-up connection to the Internet.
- You need a valid mobile service contract with a data option, which is used to calculate the associated connection costs.
- The access data of the mobile phone network provider must be set on COMAND for the connected mobile phone (▷ page 239).

-  If the connected mobile phone supports the PAN Bluetooth profile (Personal Area Network), you can use the automatic configuration function (▷ page 239).
-  You can obtain more detailed information about suitable mobile phones on the Internet at <http://www.mercedes-benz.com/connect> or from your authorized Mercedes-Benz Center.
-  If you use incorrect access data, additional costs may be incurred. This can happen when you use details that are different from the contract or details from another contract/data package.
-  The availability of individual Mercedes-Benz Apps may vary depending on the country.
-  The terms of use are shown when COMAND is used for the first time and then once a year thereafter. Only read and

accept the terms of use when the vehicle is stationary.

- i** Internet pages cannot be shown on the driver's side while the vehicle is in motion.

### Connection difficulties while the vehicle is in motion (Canada only)

The following could be the cause of call disconnection:

- insufficient GSM/UMTS network coverage
- the vehicle has moved into a GSM cell with no free channels
- the SIM card used is not compatible with the network available
- you are using a mobile phone with "Twin-card" and the mobile phone with the second SIM card is logged into the network at the same time

### Function restrictions (Canada only)

You will not be able to use the mobile phone, will no longer be able to use the mobile phone, or you may have to wait before using it, in the following situations:

- when the mobile phone is switched off
  - if the Bluetooth® function is switched off in COMAND
  - if the Bluetooth® function is switched off on the mobile phone while you are using Bluetooth® interface telephony
  - if the mobile phone has not logged on to a mobile phone network
  - if neither the mobile phone network nor the mobile phone allow simultaneous use of a phone and an Internet connection
- i** It is possible that you may not be able to receive calls when an Internet connection is active. This depends on the mobile phone and the mobile phone network used.

### Roaming (Canada only)

When you are driving your vehicle in a different country and using COMAND and Internet functions, additional costs may be incurred (roaming fees). When you are in a different country, your SIM card must be enabled for data roaming. If your mobile phone network provider does not have a data roaming agreement with the roaming partner, it may not be possible to establish an Internet connection. Deactivate this function on your mobile phone if you want to avoid data roaming when you are in a different country.

### Setting access data (Canada only)

#### Introduction



To use online and Internet functions, you need Internet access data for the connected mobile phone. You can obtain this from your mobile phone network provider.

A selected/manually set mobile phone network provider is only valid for the mobile phone connected when the selection/setting is made. The mobile phone network provider is set automatically upon reconnection.





- i** When you are driving your vehicle in a different country and using the online and Internet functions on COMAND, you may incur additional costs (roaming fees).
- i** While initializing the mobile phone for the Internet connection, access data which is already on the mobile phone may be overwritten. You should therefore check the settings on the mobile phone (see the mobile phone operating instructions).
- i** Adjust the access data settings when the vehicle is stationary. You may otherwise be distracted from the traffic conditions, cause an accident and injure yourself and others.

**Selecting/setting Internet access data**

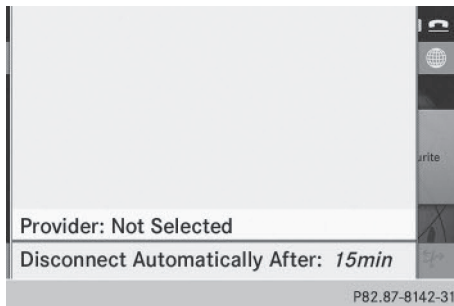
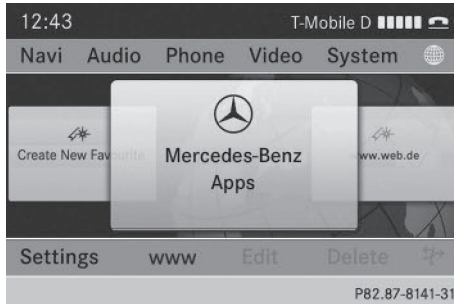
**Calling up mobile network providers**

- ▶ Select the  icon in the main function bar by turning  the COMAND controller and press  to confirm. The carousel view appears.



- ▶ Select **Settings** by sliding  and turning  the COMAND controller and press  to confirm. When you connect the mobile phone to COMAND for the first time, there is no mobile phone network provider preset. **Provider:** is followed by the words **Not Selected**. If a mobile phone is connected and a mobile phone network provider has been selected, the name of the mobile phone network is shown after **Provider:**.
- ▶ Press  the COMAND controller. The list of mobile phone network providers appears.

In order to set the access data of the mobile phone network provider you can:



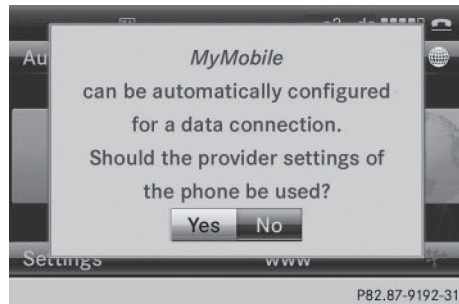

- select the predefined access data of the mobile phone network provider (▷ page 240)
- configure automatically – this option only appears in the list of providers if the connected mobile phone supports the Bluetooth® PAN (Personal Area Network) profile (▷ page 239).
- manually set the access data of the mobile phone network provider (▷ page 241)

**Configuring access data automatically**





Requirement: your telephone must be connected to COMAND via Bluetooth® and must support the Bluetooth® PAN profile.

Option 1 if your telephone is not yet configured for Internet access:

- ▶ Select the  icon in the main function bar by sliding  and turning  the COMAND controller and press  to confirm. You will see a message informing you that automatic configuration is possible.
- ▶ Select **Yes** and press  to confirm.

Option 2:

- ▶ In the list of mobile phone network providers, select **Autom. Configuration <Device\_name>** by turning  the COMAND controller and press  to confirm (▷ page 239). The configuration data is transferred from the mobile phone. If the configuration is

successful, a • dot appears in front of [Autom. configuration](#) <Device\_name>.

### Selecting access data of the mobile phone network provider



### Searching for providers

► Select [Search for Providers](#) in the mobile phone network providers list by turning  $\left[ \text{Ⓢ} \right]$  the COMAND controller and press  $\left[ \text{Ⓢ} \right]$  to confirm (▷ page 239). A list of countries appears.

► Select the country of your mobile phone network provider, e.g. [Germany](#), and press  $\left[ \text{Ⓢ} \right]$  to confirm. The list of available mobile phone network providers appears.

**i** The access data for the mobile phone network provider is selected once for the mobile phone connected and is loaded again each time the mobile phone is connected (▷ page 239).

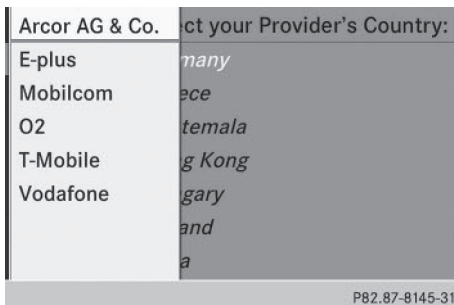

**i** You must set the access data of the mobile phone network provider who pro-

vides the SIM card and the associated data package (access settings) for the connected mobile phone. The access data remains the same when you are in a different country (roaming). The access data of another network is **not** selected.

There are mobile phone network providers who offer multiple access data. This depends on the data package used, for example.

### The mobile phone network only has one access setting

► Select the mobile phone network provider by turning  $\left[ \text{Ⓢ} \right]$  the COMAND controller and press  $\left[ \text{Ⓢ} \right]$  to confirm. A menu appears.

► **To check preset access data:** select [Edit](#) and confirm with  $\left[ \text{Ⓢ} \right]$ . The list of access data appears (▷ page 241).

► Check the access data.

► **If the access data is correct:** press the  $\left[ \text{⏪} \right]$  reset button or the  $\left[ \text{⏩} \right]$  symbol and press  $\left[ \text{Ⓢ} \right]$  to confirm. You can now accept the access data of the mobile phone network provider.

► Select [Save](#) and press  $\left[ \text{Ⓢ} \right]$  to confirm. The list of mobile phone network providers appears; the access data of the provider has been accepted.

► **To edit the access data:** proceed as described for manually entering the access data (▷ page 241). When you confirm the edited access data, the list of mobile phone network providers appears and displays the selected provider.

### If, after selecting a mobile phone network provider, several access settings are displayed:

► Select the appropriate access setting by turning  $\left[ \text{Ⓢ} \right]$  the COMAND controller and press  $\left[ \text{Ⓢ} \right]$  to confirm. A menu appears.

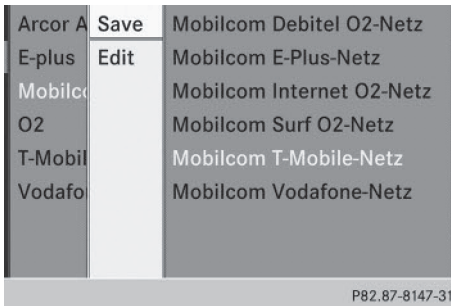

- ▶ **To check access settings:** select **Edit** and press to confirm. The list of access data appears (▷ page 241).
- ▶ Check the access data.
- ▶ **If the access data is correct:** press the reset button or the symbol and press to confirm. You can now accept the access data of the mobile phone network provider.
- ▶ Select **Save** and press to confirm. The list of mobile phone network providers appears; the access data of the provider has been accepted.
- ▶ **To edit the access data:** proceed as described in "Manually setting the access data of the mobile phone network provider" (▷ page 241). When you confirm the edited access data, the list of mobile phone network providers appears and displays the selected provider.

The currently selected access settings (● dot in front of the entry) are used for the connected mobile phone.

- ▶ **To return to the carousel view:** press the back button twice.
- or
- ▶ Press the COMAND controller and then the back button.

**Manually setting the access data of the mobile phone network provider**

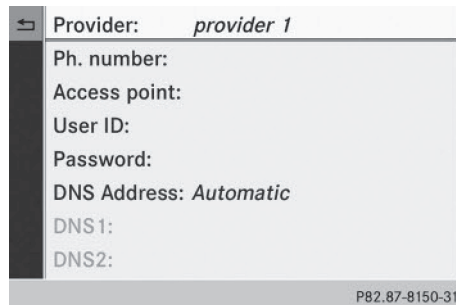
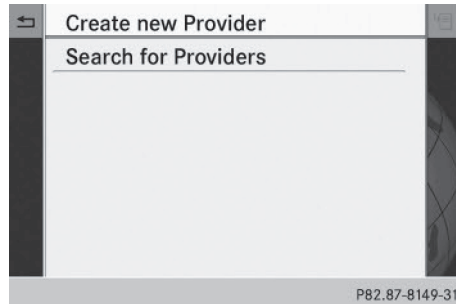

List of access data (new provider)

**Calling up the list of access data**

- ▶ Confirm **Create New Provider** in the list of mobile phone network providers by pressing the COMAND controller. The list of access data appears. The standard name **Provider <x>** is automatically entered into the **Provider:** field. You can now make the entries.
- i** The access data of the mobile phone network provider is set once for the connected mobile phone.

COMAND

## Explanation of the access data







Input field	Meaning
Provider:	Name of the provider to be displayed in the list of mobile phone network providers. The name can be freely selected. The standard entry is <b>Provider &lt;x&gt;</b> .
Te1. Number:	Access number for establishing the connection <b>i</b> The access number depends on the mobile phone used. For GSM/UMTS mobile phones, <b>*99***1#</b> is used as a standard.
Access Point:	APN network access point ( <b>Access Point Name</b> ) You can obtain this information from your mobile phone network provider. <b>i</b> Entry is not necessary for all mobile phone network providers and mobile phones.
User ID:	The user identification can be obtained from your mobile phone network provider. <b>i</b> Entry is not necessary for all mobile phone network providers.
Password:	The password can be obtained from your mobile phone network provider. <b>i</b> Entry is not necessary for all mobile phone network providers.

Input field	Meaning
DNS Address:	The DNS addresses ( <b>Domain Name Service</b> ) can be negotiated automatically or entered manually. The required information can be obtained from your mobile phone network provider. <b>i</b> Most mobile phone network providers support the <b>Automatic</b> function. If you selected the <b>Manual</b> option, you are usually required to enter a DNS address.
DNS1: DNS2:	Fields for entering the DNS server addresses manually. The address can be obtained from your mobile phone network provider.

## Establishing/ending the connection

## Establishing the connection

Preconditions for establishing a connection can be found under "General notes" (> page 237).

- ▶ **Option 1:** select the  icon in the main function bar by turning  the COMAND controller and press  to confirm. The carousel view appears.
- ▶ Turn  or slide   the COMAND controller until the **Mercedes-Benz Apps** panel or a favorite is brought to the front, if these have been previously created.
- ▶ **Option 2:** enter a web address (> page 244).



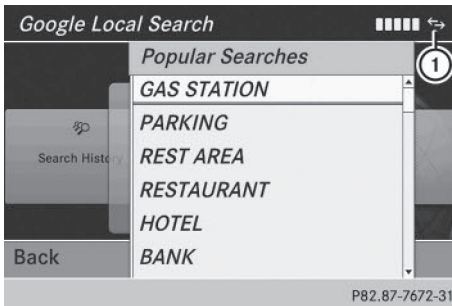
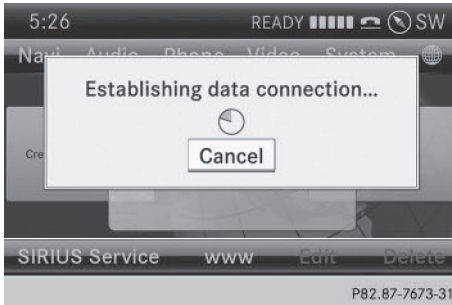

▶ For both options, press the COMAND controller.  
The Internet connection is established. An active Internet connection is identified with symbol ①. The example shows the menu in the Google™ Local Search function.

▶ **To cancel the connection:** while the connection is being established, confirm **Cancel** by pressing the COMAND controller.

or

▶ Press the button on COMAND or on the multifunction steering wheel.

### Ending the connection

**US only:** you cannot cancel the connection yourself.

The Internet connection is automatically terminated if the system does not recognize any user input within a five-minute time period.

**i** The button is inoperative.

**Canada only:**

▶ Press the button on COMAND or on the multifunction steering wheel.

or

▶ Select the scissors symbol on the bottom right of the carousel view and press the COMAND controller to confirm.

**i** If the mobile phone Internet connection is canceled, COMAND tries to reconnect. You should therefore always close the connection on COMAND or via the multifunction steering wheel.

### Internet radio

#### General notes

A good Internet connection is required to transmit audio data efficiently. To ensure the best-possible reception, your mobile phone should be connected to the vehicle's exterior antenna via the phone bracket (optional).

Bear in mind that a relatively large volume of data can be transmitted when using the Internet radio. An average 128 kbit per second data transfer rate can transfer 56MB of data in one hour.

The data transfer rate of a station is displayed while receiving data.

#### Calling up the Internet radio





▶ Select the icon in the main function bar by sliding the COMAND controller and turning the COMAND controller to the



COMAND controller and press  to confirm.



The carousel view appears.

- ▶ Bring the **Internet Radio** panel to the front by turning  the COMAND controller and press  to confirm. The Internet radio menu appears.

### Searching for stations



- ▶ Select **Search** in the Internet radio menu. A list with search criteria appears.
  - ▶ Select criterion and press  to confirm.
- i** For example as a search criterion, you can set an Internet radio station that is located close to your navigation destination.

### Connecting to a station



- ▶ Search for a station (▶ page 244).
- ▶ Select  (play) in the Internet radio menu and press  to confirm. The call is placed.

If the data stream is interrupted, an automatic attempt is made to re-establish the connection.

Manually re-establishing a connection

- ▶ Select  (play) again in the Internet radio menu and press  to confirm.

Ending data transfer:

- ▶ Select  (stop) in the Internet radio menu and press  to confirm.

or

- ▶ Change to another audio source, for example **Disc**.

If you change to a main function that is not an audio source, e.g. navigation, the data connection remains on. You can continue listening to the set station.

## Internet



### Display restriction

Internet pages cannot be shown while the vehicle is in motion.

### Calling up a website

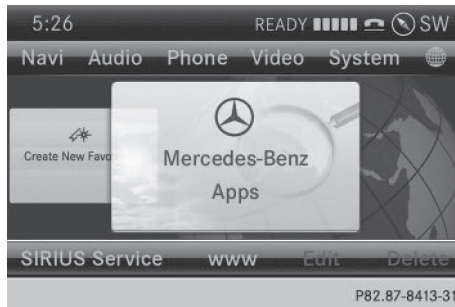
#### Calling up the carousel view





- ▶ Select the  symbol in the main function bar by turning  the COMAND controller and press  to confirm. The carousel view appears.





You can now enter a web address.

#### Entering a web address









You can enter the web address using either the character bar or the number keypad.

- ▶ Select **www** by sliding  and turning  the COMAND controller and press  to confirm. An input menu appears.

- ▶ **To enter using the character bar:** enter the web address in the input line.  
As soon as the first letter has been entered in the input line, a list appears below it. The list shows web addresses which begin with the letters you have entered and web addresses which have already been called up.  
The list is empty the first time you call it up.
- ▶ After entering the web address, select the  symbol by sliding  and turning  the COMAND controller and press  to confirm.  
The website is called up.

## Navigating the website

### Overview

Step	Result
▶ Turn  the controller.	Navigates from one item that can be selected (e.g. link, text field or selection list) to the next and highlights the respective element on the website.
Sliding the controller: ▶ Left or right  ▶ Up or down  ▶ Diagonally 	Moves the pointer on the page.
▶ Press  the controller.	Calls up the menu or opens the selected item.
▶ Press  .	Calls up the previous page.
▶ Press  .	Closes the Internet browser. If several windows are open, the current window is closed.



Useful information .....	248
Stowage areas .....	248
Features .....	255

### Useful information

- i** This Operator's Manual describes all models and all standard and optional equipment of your vehicle available at the time of publication of the Operator's Manual. Country-specific differences are possible. Please note that your vehicle may not be equipped with all features described. This also applies to safety-related systems and functions.
- i** Read the information on qualified specialist workshops (▷ page 35).

### Stowage areas

#### Loading guidelines

##### WARNING

If objects, luggage or loads are not secured or not secured sufficiently, they could slip, tip over or be flung around and thereby hit vehicle occupants. There is a risk of injury, particularly in the event of sudden braking or a sudden change in direction.

Always store objects so that they cannot be flung around. Secure objects, luggage or loads against slipping or tipping before the journey.

##### WARNING

Combustion engines emit poisonous exhaust gases such as carbon monoxide. If the tailgate is open when the engine is running, particularly if the vehicle is moving, exhaust fumes could enter the passenger compartment. There is a risk of poisoning.

Turn off the engine before opening the tailgate. Never drive with the tailgate open.

##### WARNING

The exhaust tail pipe and tail pipe trim can become very hot. If you come into contact with these parts of the vehicle, you could burn yourself. There is a risk of injury.

Always be particularly careful around the exhaust tail pipe and the tail pipe trim. Allow these components to cool down before touching them.

The gross vehicle weight (GVW) is the vehicle weight including fuel, vehicle tool kit, spare wheel, installed accessories, vehicle occupants and luggage/cargo.

Do not exceed the load limit or permitted gross vehicle weight rating (GVWR) for your vehicle. The gross load limit and the GVWR are specified on the vehicle identification plate on the B-pillar of the driver's door (▷ page 303).

The load must also be distributed so that the weight on each axle never exceeds the gross axle weight rating (GAWR) for the front and rear axles. The specifications for GVWR and GAWR are on the vehicle identification plate on the B-pillar of the driver's door (▷ page 303).

Observe the notes on loading the vehicle (▷ page 303).

The handling characteristics of a laden vehicle are dependent on the distribution of the load within the vehicle. For this reason, you should observe the following notes when transporting a load:

- Never exceed the maximum permissible gross vehicle mass or the gross axle weight rating for the vehicle (including occupants).
- The cargo compartment is the preferred place to carry objects.
- Position heavy loads as far forwards as possible and as low down in the cargo compartment as possible.
- The load must not protrude above the upper edge of the seat backrests.
- Always place the load against the rear or front seat backrests. Make sure that the seat backrests are securely locked into place.
- Always place the load behind unoccupied seats if possible.

- Use the cargo tie-down rings and the parcel nets to transport loads and luggage.
- Use cargo tie-down rings and fastening materials appropriate for the weight and size of the load.
- Secure the load with sufficiently strong and wear-resistant tie-downs. Pad sharp edges for protection.

### Stowage spaces

#### Important safety notes

##### WARNING

If objects in the passenger compartment are stowed incorrectly, they can slide or be thrown around and hit vehicle occupants. There is a risk of injury, particularly in the event of sudden braking or a sudden change in direction.

- Always stow objects so that they cannot be thrown around in such situations.
- Always make sure that objects do not protrude from stowage spaces, parcel nets or stowage nets.
- Close the lockable stowage spaces while driving.
- Stow and secure objects that are heavy, hard, pointy, sharp-edged, fragile or too large in the cargo compartment.

Observe the loading guidelines (▷ page 248).

#### Information in the Digital Operator's Manual

In the Digital Operator's Manual you will find information on the following topics:

- Glove box
- Stowage compartment under the armrest
- Eyeglasses compartment
- Stowage compartment in the front center console
- Stowage compartment in the rear center console

### Stowage net

##### WARNING

Vehicles with the Occupant Classification System (OCS):

If the gross weight of the objects in the stowage net on the back of the front-passenger seat is greater than 4.4 lb (2 kg), OCS cannot correctly assess the occupant's weight category. The front-passenger front air bag could deploy without cause, or may fail to deploy in the event of an accident. This poses an increased risk of injury or even fatal injury.

Always observe the permissible gross weight of 4.4 lb (2 kg). Stow and secure heavy objects in the cargo compartment.

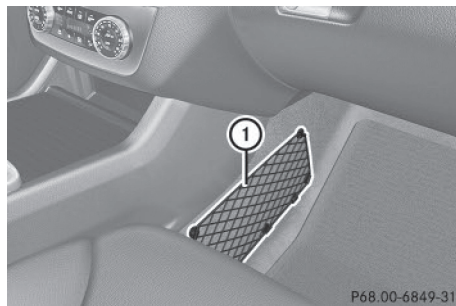

① Stowage net in front-passenger footwell



① Stowage net on the back of the front seats

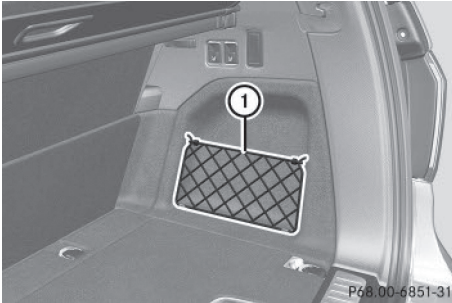

#### ① Storage net in cargo compartment

Observe the loading guidelines (▷ page 248) and the safety notes regarding storage spaces (▷ page 249).

#### Through-loading facility in the rear

If objects or loads are not secured when being transported in the through-loading facility, they could slip or be thrown around and thereby hit vehicle occupants.

Observe the loading guidelines (▷ page 248) and the safety notes regarding storage spaces (▷ page 249).

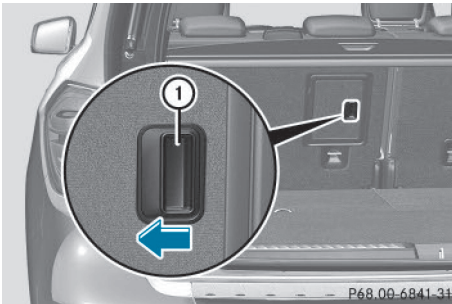

The through-loading facility is opened from the cargo compartment.

- ▶ Release the seat backrests in the second row of seats and tilt them in the cargo/load position. You can find information about this in the Digital Operator's Manual.
- ▶ Fold down the rear seat armrest.

- ▶ Pull the center head restraint on the rear bench seat into the uppermost position (▷ page 110).
- ▶ Slide release catch ① to the left and swing flap ② to the left until it is lying on the rear side of the rear bench seat.

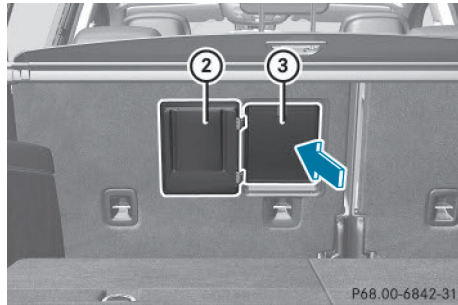

- ▶ Push cover ③ forward until it is lying on the rear seat armrest.

#### Cargo compartment enlargement

#### Important safety notes

##### WARNING

If the rear bench seat/rear seat and seat backrest are not engaged they could fold forwards, e.g. when braking suddenly or in the event of an accident.

- The vehicle occupant would thereby be pushed into the seat belt by the rear bench seat/rear seat or by the seat backrest. The seat belt can no longer offer the intended level of protection and could even cause injuries.
- Objects or loads in the trunk/cargo compartment cannot be restrained by the seat backrest.

There is an increased risk of injury.

Before every trip, make sure that the seat backrests and the rear bench seat/rear seat are engaged.

Make sure that the seat backrest and the seat cushion are correctly engaged in position.



**!** Release and fold the seat cushion upwards before folding the rear bench seat forward. Otherwise, the backrests may be damaged.

When the backrest is folded forwards, the front seats cannot be moved to their rear-most position. Otherwise, the front seats and the rear bench seat could be damaged.

**!** The backrest is heavy. Therefore, take care when folding it down. Make sure that the head restraints are pushed all the way in so that the backrests and seat cushions are not damaged.

Observe the loading guidelines (▷ page 248). The left-hand and right-hand backrests in the second row of seats can be folded forwards separately to increase the cargo compartment capacity.

For vehicles with a 3rd row of seats, you must fold down the 3rd row of seats beforehand to obtain maximum cargo compartment enlargement. You can find information about this in the Digital Operator's Manual.

### Folding the rear bench seat forwards

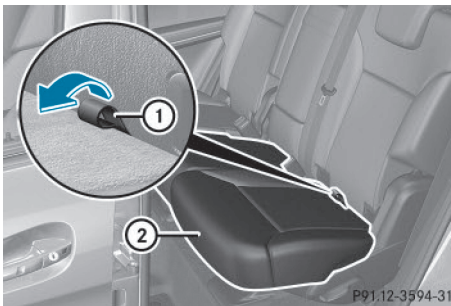

If the driver's or front-passenger seat is set for a larger person, it may not be possible to fold the rear bench seat forward. In this case, move the front seats as far forward as possible.

- ▶ Move the head restraints to the lowest position. You can find information about this in the Digital Operator's Manual.
- ▶ Pull release loop ① of seat cushion ②.
- ▶ Fold seat cushion ② up.

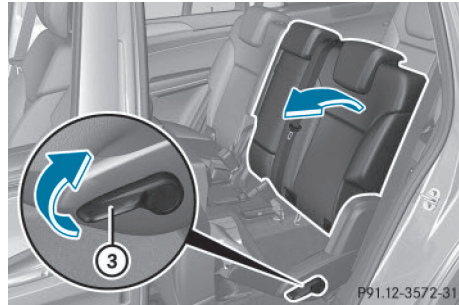

- ▶ Pull release handle ③ in the direction of the arrow. The backrest is released.
- ▶ Fold the backrest forward until it reaches the cargo compartment position.

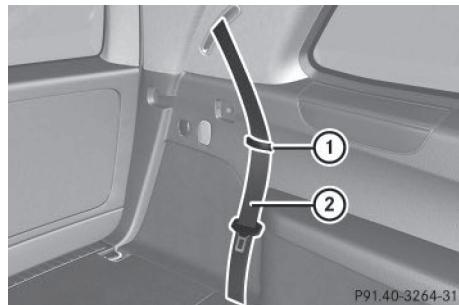

- ▶ Guide seat belts ② under respective clips ①.



### Folding the rear bench seat back

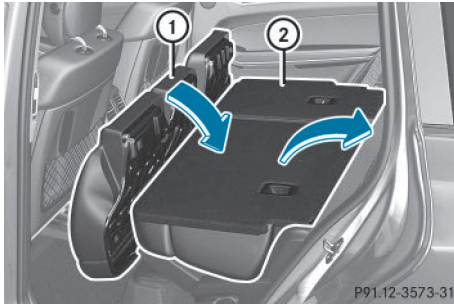

- ▶ Fold seat backrest ② back until it engages. Make sure not to trap the seat belt while doing so.
- ▶ Swing seat cushion ① back.
- ▶ Pull up and adjust the head restraints if necessary. You can find information about this in the Digital Operator's Manual.

### Securing cargo

#### Cargo tie-down rings

##### General notes

##### WARNING

The Top Tether anchorages cannot secure a load. If you secure a load with the Top Tether anchorages, the Top Tether anchorages could be pulled out during braking, abrupt changes in direction or in the event of an accident. The load could slip, tip over or be flung around and thereby hit vehicle occupants. There is a risk of injury.

Only use the cargo tie down rings when securing a load.

Observe the following notes on securing loads:

- Secure the load using the cargo tie-down rings.
- Distribute the load on the cargo tie-down rings evenly.

- Do not use elastic straps or nets to secure a load, as these are only intended as an anti-slip protection for light loads.
- Do not route tie-downs across sharp edges or corners.
- Pad sharp edges for protection.

### Cargo compartment

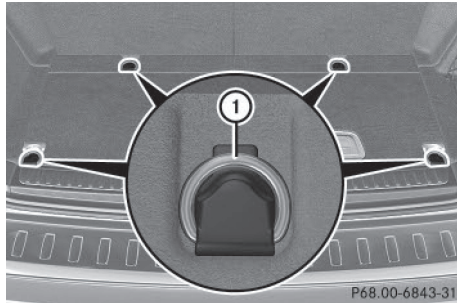

There are four cargo tie-down rings ① in the cargo compartment.

### Bag hook

##### WARNING

The bag hooks cannot restrain heavy objects or items of luggage. Objects or items of luggage could be flung around and thereby hit vehicle occupants when braking or abruptly changing directions. There is a risk of injury.

Only hang light objects on the bag hooks. Never hang hard, sharp-edged or fragile objects on the bag hooks.

- ❗ The bag hook can bear a maximum load of 6.6lbs (3kg) and should not be used to secure a load.

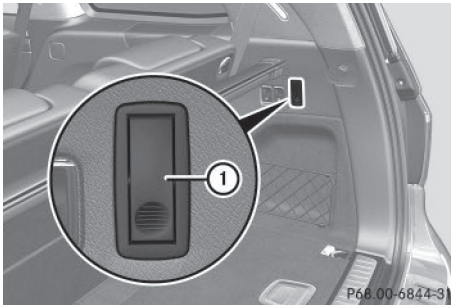

There is a bag hook in the cargo compartment on the right-hand side.

- ▶ Press bag hook marking ①.
- ▶ Turn bag hook ① until it engages.

### Cargo compartment cover

#### Important safety notes

##### **WARNING**

On its own, the cargo compartment cover cannot secure or restrain heavy objects, items of luggage and heavy loads. You could be hit by an unsecured load during sudden changes in direction, braking or in the event of an accident. There is an increased risk of injury or even fatal injury.

Always store objects so that they cannot be flung around. Secure objects, luggage or loads against slipping or tipping over, e.g. by using tie downs, even if you are using the cargo compartment cover.

- ❗ When loading the vehicle, make sure that you do not stack the load in the cargo compartment higher than the lower edge of the side windows. Do not place heavy objects on top of the cargo compartment cover.

The cargo compartment cover may be installed behind the 2nd or 3rd row of seats.

#### Extending/retracting the cargo compartment cover

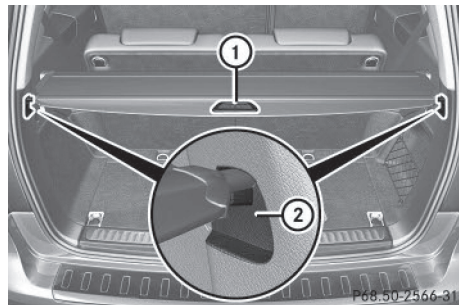

- ▶ **To extend:** pull the cargo compartment cover back by grab handle ① and clip it into retainers ② on the left and right.
- ▶ **To retract:** unhook the cargo compartment cover from left-hand and right-hand retainers ②.
- ▶ Guide cargo compartment cover forwards by grab handle ① until it is completely rolled up.

#### Coat hooks on the tailgate

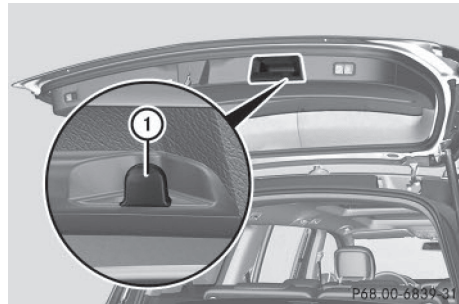

- ① Coat hook

#### Stowage well under the cargo compartment floor

#### Important safety notes

##### **WARNING**

If you drive when the cargo compartment floor is open, objects could be flung around, thus

striking vehicle occupants. There is a risk of injury, particularly in the event of sudden braking or a sudden change in direction. Always close the cargo compartment floor before a journey.

The TIREFIT kit, tire-change tool kit, etc. are located in the stowage compartment.

### Opening/closing the cargo compartment floor

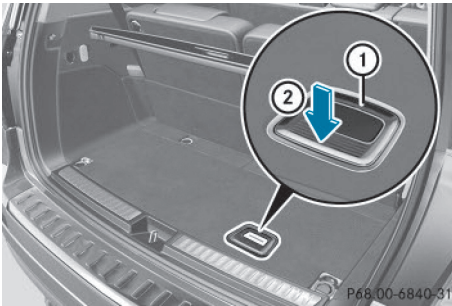

- ▶ **To open:** holding the ribbing, press handle ① down ②. Handle ① folds up.
- ▶ Swing the cargo compartment floor upwards using handle ① until it rests against the cargo compartment cover.

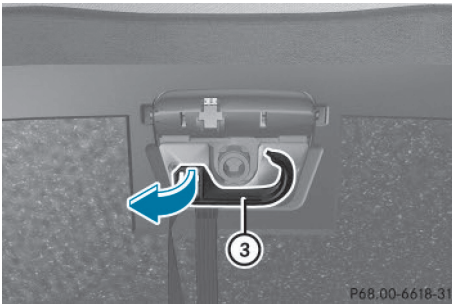

- ▶ Fold out hook ③ on the underside of the cargo compartment floor in the direction of the arrow.

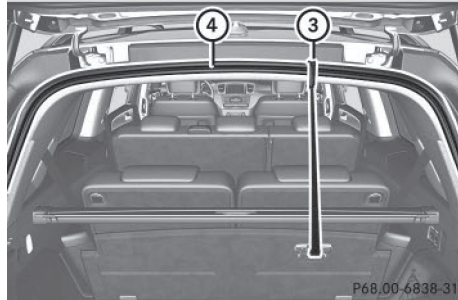

- ▶ Attach hook ③ to the cargo compartment's upper seal ④.
- ▶ **To close:** detach hook ③ from the cargo compartment's upper seal ④.
- ▶ Fasten hook ③ to the bracket on the underside of the cargo compartment floor.
- ▶ Fold the cargo compartment floor down.
- ▶ Press the cargo compartment floor down ② until it engages.

### Locking and unlocking the cargo compartment floor

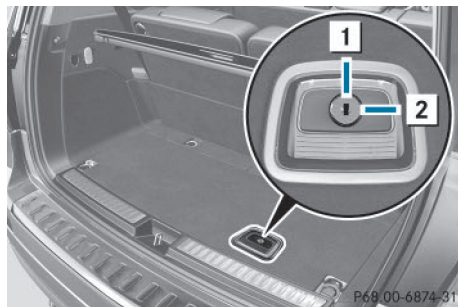

- ① Cargo compartment floor unlocked
- ② Cargo compartment floor locked

The cargo compartment floor can be locked and unlocked using the mechanical key.

## Roof carrier

### Important safety notes

#### WARNING

When you load the roof, the center of gravity of the vehicle rises and the driving characteristics change. If you exceed the maximum roof load, the driving characteristics, as well as steering and braking, will be greatly impaired. There is a risk of an accident.

Never exceed the maximum roof load and adjust your driving style.

- !** Mercedes-Benz recommends that you only use roof carriers that have been tested and approved for Mercedes-Benz vehicles. This helps to prevent damage to the vehicle.

Position the load on the roof carrier in such a way that the vehicle will not sustain damage even when it is in motion.

Depending on the vehicle equipment, ensure that when the roof carrier is installed you can:

- raise the sliding sunroof fully
- open the panorama roof with power tilt/sliding panel fully
- open the tailgate fully

You will find information on the maximum roof load in the "Technical data" section (> page 340).

An incorrectly secured roof carrier or roof load may become detached from the vehicle. You must therefore ensure that you observe the roof carrier manufacturer's installation instructions.

## Attaching the roof carrier



- ▶ Secure the roof carrier to roof rails ①. In doing so, observe the manufacturer's installation instructions.

## Features

### Information in the Digital Operator's Manual

In the Digital Operator's Manual you will find information on the following topics:

- Cup holder
- Roller sunblinds on the rear side windows
- Ashtray
- Cigarette lighter
- 12 V sockets
- 115 V socket
- Infrared reflective windshield

## Sun visors

### Overview

#### WARNING

If the mirror cover of the vanity mirror is folded up when the vehicle is in motion, you could be blinded by incident light. There is a risk of an accident.

Always keep the mirror cover folded down while driving.

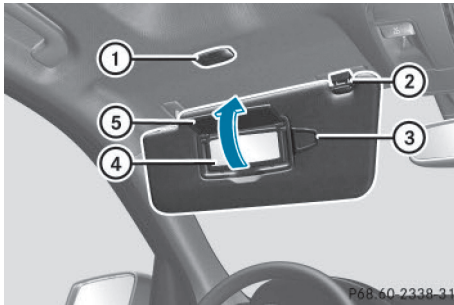

- ① Mirror light
- ② Bracket
- ③ Retaining clip, e.g. for a car park ticket
- ④ Vanity mirror
- ⑤ Mirror cover

### Information in the Digital Operator's Manual

In the Digital Operator's Manual you will find information on the following topics:

- Vanity mirror in the sun visor
- Glare from the side

### mbrace

### Information in the Digital Operator's Manual

In the Digital Operator's Manual you will find information on the following topics:

- Downloading destinations in COMAND
- Search and Send
- Vehicle remote opening
- Vehicle remote closing
- Stolen vehicle recovery service
- Vehicle remote malfunction diagnosis
- Downloading routes
- Speed alert
- Geo fencing
- Triggering the vehicle alarm

### General notes

You must have a license agreement to activate the mbrace service. Make sure that your system is activated and operational. To log in, press the MB Info call button. If any of the steps mentioned are not carried out, the system may not be activated.

If you have questions about the activation, contact one of the following telephone hot-lines:

- **USA:** Mercedes-Benz Customer Assistance Center at 1-800-FOR-MERCEdes (1-800-367-6372) or 1-866-990-9007
- **Canada:** Customer Service at 1-888-923-8367

Shortly after successfully registering with the service, a user ID and password will be sent to you by post.

USA only: you can use this password to log onto the mbrace area under "Owners Online" at <http://www.mbusa.com>.

The system is available if:

- it has been activated and is operational
- the corresponding mobile phone network is available for transmitting data to the Customer Center
- a service subscription is available
- the starter battery is sufficiently charged

**i** Determining the location of the vehicle on a map is only possible if:

- GPS reception is available.
- the vehicle position can be forwarded to the Customer Assistance Center.

### The mbrace system

To adjust the volume during a call, proceed as follows:

- ▶ Press the or button on the multifunction steering wheel.

or

- ▶ Use the volume controller of the audio system/COMAND.



The system offers various services, e.g.:





- Automatic and manual emergency call
- Roadside Assistance call
- MB Info call

USA only: you can find information and a description of all available features under "Owners Online" at <http://www.mbusa.com>.

### System self-test

After you have switched on the ignition, the system carries out a self-diagnosis.

A malfunction in the system has been detected if one of the following occurs:

- The indicator lamp in the SOS button does not come on during the system self-test.
- The indicator lamp in the  Roadside Assistance button does not light up during self-diagnosis of the system.
- The indicator lamp in the  MB Info call button does not light up during self-diagnosis of the system.
- The indicator lamp in one or more of the following buttons continues to light up red after the system self-diagnosis:
  - SOS button
  -  Roadside Assistance call button
  -  MB Info call button
- After the system self-diagnosis, the **Inoperative** or **Service Not Activated** message appears in the multifunction display.

If a malfunction is indicated as outlined above, the system may not operate as expected. In the event of an emergency, help will have to be summoned by other means.

Have the system checked at the nearest authorized Mercedes-Benz Center or contact the following service hotlines:

- **USA:** Mercedes-Benz Customer Assistance Center at 1-800-FOR-MERcedes (1-800-367-6372) or 1-866-990-9007
- **Canada:** Customer Service at 1-888-923-8367

### Emergency call

#### Important safety notes

##### **WARNING**

It can be dangerous to remain in the vehicle, even if you have pressed the SOS button in an emergency if:

- you see smoke inside or outside of the vehicle, e.g. if there is a fire after an accident
- the vehicle is on a dangerous section of road
- the vehicle is not visible or cannot easily be seen by other road users, particularly when dark or in poor visibility conditions

There is a risk of an accident and injury.

Leave the vehicle immediately in this or similar situations as soon as it is safe to do so. Move to a safe location along with other vehicle occupants. In such situations, secure the vehicle in accordance with national regulations, e.g. with a warning triangle.

You must have a license agreement to activate the mbrace service. Make sure that your system is activated and operational. To register, press the  MB Info call button. If any of the steps mentioned are not carried out, the system may not be activated.

If you have questions about the activation, contact one of the following telephone hotlines:

- **USA:** Mercedes-Benz Customer Assistance Center at 1-800-FOR-MERcedes (1-800-367-6372) or 1-866-990-9007
- **Canada:** Customer Service at 1-888-923-8367

#### General notes

An emergency call is dialed automatically if an air bag or Emergency Tensioning Device is triggered.

-  You cannot end an automatically triggered emergency call yourself.

An emergency call can also be initiated manually.

As soon as the emergency call has been initiated, the indicator lamp in the SOS button flashes. The multifunction display shows the **Connecting Call** message.

The audio output is muted.

Once the connection has been made, the **Call Connected** message appears in the multifunction display.

All important information on the emergency is transmitted, for example:

- current location of the vehicle (as determined by the GPS system)
- vehicle identification number
- information on the severity of the accident

Shortly after the emergency call has been initiated, a voice connection is automatically established between the Customer Assistance Center and the vehicle occupants.

- If the vehicle occupants respond, the Mercedes-Benz Customer Assistance Center attempts to get more information on the emergency.
- If there is no response from the vehicle occupants, an ambulance is immediately sent to the vehicle.

If no voice connection can be established to the Mercedes-Benz Customer Assistance Center, the system has been unable to initiate an emergency call.

This can occur, for example, if the relevant mobile phone network is not available. The indicator lamp in the SOS button flashes continuously.

The **Call Failed** message appears in the multifunction display and must be confirmed. In this case, summon assistance by other means.

## Making an emergency call

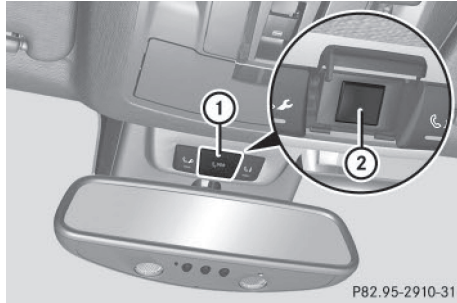

- ▶ **To initiate an emergency call manually:** press cover ① briefly to open.
- ▶ Press SOS button ② briefly. The indicator lamp in SOS button ② flashes until the emergency call is concluded.
- ▶ Wait for a voice connection to the Mercedes-Benz Customer Assistance Center.
- ▶ After the emergency call, close cover ①.

- ❗ If the mobile phone network is unavailable, mbrace will not be able to make the emergency call. If you leave the vehicle immediately after pressing the SOS button, you will not know whether mbrace placed the emergency call. In this case, always summon assistance by other means.

## Roadside Assistance button



- ▶ Press Roadside Assistance button ①. This initiates a call to the Mercedes-Benz Customer Assistance Center.

The indicator lamp in Roadside Assistance button ① flashes while the call is active. The multifunction display shows the **Connecting Call** message. The audio output is muted.

If a connection can be made, the **Call Connected** message appears in the multifunction display.

If a mobile phone network and GPS reception are available, the system transfers data to the Mercedes-Benz Customer Assistance Center, for example:

- current location of the vehicle
- vehicle identification number

**i** The audio system or COMAND display indicates that a call is active. During the call, you can change to the navigation menu by pressing the NAVI button on COMAND, for example.

Voice output is not available.

A voice connection is established between the Mercedes-Benz Customer Assistance Center and the vehicle occupants.

From the vehicle remote malfunction diagnosis, the Mercedes-Benz Customer Assistance Center can ascertain the nature of the problem. Information on the vehicle remote malfunction diagnosis can be found in the Digital Operator's Manual.

The Mercedes-Benz Customer Assistance Center either sends a qualified Mercedes-Benz technician or makes arrangements for your vehicle to be transported to the nearest authorized Mercedes-Benz Center.

You may be charged for services such as repair work and/or towing.

Further details are available in your mbrace manual.

**i** The system has not been able to initiate a Roadside Assistance call, if:

- the indicator lamp for Roadside Assistance call button ① is flashing continuously.
- no voice connection to the Mercedes-Benz Customer Assistance Center was established.

This can occur if the relevant mobile phone network is not available, for example.

The **Call Failed** message appears in the multifunction display.

► **To end a call:** press the  button on the multifunction steering wheel.

or

► Press the corresponding button for ending a phone call on the audio system or on COMAND.

### MB Info call button



► Press MB Info call button ①.

This initiates a call to the Mercedes-Benz Customer Assistance Center.

The indicator lamp in MB Info call button ① flashes while the connection is being made. The multifunction display shows the **Connecting Call** message. The audio system is muted.

If a connection can be made, the **Call Connected** message appears in the multifunction display.



If a mobile phone network and GPS reception are available, the system transfers data to the Mercedes-Benz Customer Assistance Center, for example:

- current location of the vehicle
- vehicle identification number

**i** The audio system or COMAND display indicates that a call is active. During the call, you can change to the navigation menu by pressing the NAVI button on COMAND, for example.

Voice output is not available.

A voice connection is established between the Mercedes-Benz Customer Assistance Center and the vehicle occupants.

You receive information about operating your vehicle, about the nearest authorized Mercedes-Benz Center and about other products and services from Mercedes-Benz.

USA only: you can find further information on the mbrace system under "Owners Online" at <http://www.mbusa.com>.

**i** The system has not been able to initiate an MB Info call, if:

- the indicator lamp in MB Info call button  is flashing continuously.
- no voice connection to the Mercedes-Benz Customer Assistance Center was established.

This can occur if the relevant mobile phone network is not available, for example.

The **Call Failed** message appears in the multifunction display.

► **To end a call:** press the  button on the multifunction steering wheel.

or

► Press the corresponding button for ending a phone call on the audio system or on COMAND.

## Call priority

When service calls are active, e.g. Roadside Assistance or MB Info calls, an emergency call can still be initiated. In this case, an emergency call will take priority and override all other active calls.

The indicator lamp of the respective button flashes until the call is ended.

An emergency call can only be terminated by the Mercedes-Benz Customer Assistance Center.

All other calls can be ended by pressing:

- the  button on the multifunction steering wheel
- the corresponding button on the audio system or on COMAND for ending a telephone call

**i** When a call is initiated, the audio system is muted. The mobile phone is no longer connected to COMAND. However, if you want to use your mobile phone, do so only when the vehicle is stationary and in a safe location.

## Garage door opener

### General notes

The HomeLink® garage door opener integrated in the rear-view mirror allows you to operate up to three different door and gate systems.

Use the integrated garage door opener only on garage doors that:

- have safety stop and reverse features and
- meet current U.S. federal safety standards

Once programmed, the integrated garage door opener in the rear-view mirror will assume the function of the garage door system's remote control. Please also read the operating instructions for the garage door system.

When programming a garage door opener, park the vehicle outside the garage. Do not run the engine while programming.

Certain garage door drives are incompatible with the integrated garage door opener. If you have difficulty programming the integrated garage door opener, contact an authorized Mercedes-Benz Center.

Alternatively, you can call the following telephone assistance services:

- **USA:** Mercedes-Benz Customer Assistance Center at 1-800-FOR-MERCEdes
- **Canada:** Customer Service at 1-800-387-0100
- HomeLink® hotline 1-800-355-3515 (free of charge)

More information on HomeLink® and/or compatible products is also available online at <http://www.homelink.com>.

Notes on the declaration of conformity (> page 34).

USA: FCC ID: CB2HMIHL4

Canada: IC: 279B-HMIHL4

### Important safety notes

#### WARNING

When you operate or program the garage door with the integrated garage door opener, persons in the range of movement of the garage door can become trapped or struck by the garage door. There is a risk of injury.

When using the integrated garage door opener, always make sure that nobody is within the range of movement of the garage door.

#### WARNING

Combustion engines emit poisonous exhaust gases such as carbon monoxide. Inhaling these exhaust gases leads to poisoning. There is a risk of fatal injury. Therefore never leave the engine running in enclosed spaces without sufficient ventilation.

## Programming

### Programming buttons

Pay attention to the "Important safety notes" (> page 261).

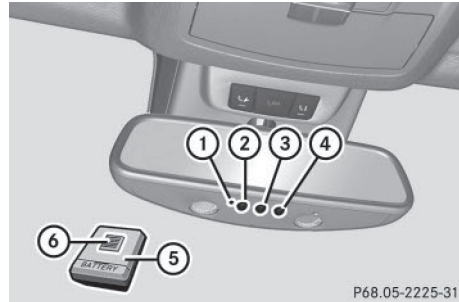

P68.05-2225-31

Garage door remote control ⑤ is not included with the integrated garage door opener.

- ▶ Turn the SmartKey to position **2** in the ignition lock (> page 135).
- ▶ Select one of buttons ② to ④ to use to control the garage door drive.
- ▶ **To start programming mode:** press and hold one of buttons ② to ④ on the integrated garage door opener. The garage door opener is now in programming mode. After a short time, indicator lamp ① lights up yellow. Indicator lamp ① lights up yellow as soon as button ②, ③ or ④ is programmed for the first time. If the selected button has already been programmed, indicator lamp ① will only light up yellow after ten seconds have elapsed.
- ▶ Release button ②, ③ or ④. Indicator lamp ① flashes yellow.
- ▶ **To program the remote control:** point garage door remote control ⑤ towards buttons ② to ④ on the rear-view mirror at a distance of 2 to 8 inches (5 to 20 cm).
- ▶ Press and hold button ⑥ on remote control ⑤ until indicator lamp ① lights up green. When indicator lamp ① lights up green: programming is finished. When indicator lamp ① flashes green: programming was successful. The next step is

to synchronize the rolling code  
(▷ page 262).

- ▶ Release button ⑥ on remote control ⑤ for the garage door drive system. If indicator lamp ① lights up red: repeat the programming procedure for the corresponding button on the rear-view mirror. When doing so, vary the distance between remote control ⑤ and the rear-view mirror.

The required distance between remote control ⑤ and the integrated garage door opener depends on the garage door drive system. Several attempts might be necessary. You should test every position for at least 25 seconds before trying another position.

### Synchronizing the rolling code

Pay attention to the "Important safety notes" (▷ page 261).

If the garage door system uses a rolling code, you will also have to synchronize the garage door system with the integrated garage door opener in the rear-view mirror. To do this you will need to use the programming button on the door drive control panel. The programming button may be positioned in different places depending on the manufacturer. It is usually located on the door drive unit on the garage ceiling.

Familiarize yourself with the garage door drive operating instructions, e.g. under "Programming of additional remote controls", before carrying out the following steps.

Your vehicle must be within reach of the garage door or gate opener drive. Make sure that neither your vehicle nor any persons/objects are present within the sweep of the door or gate.

- ▶ Turn the SmartKey to position 2 in the ignition lock (▷ page 135).
- ▶ Get out of the vehicle.
- ▶ Press the programming button on the door drive unit.

Usually, you now have 30 seconds to initiate the next step.

- ▶ Get into the vehicle.
- ▶ Press previously programmed button ②, ③ or ④ on the integrated garage door opener multiple times until the door closes. The rolling code synchronization is then complete.

### Notes on programming the remote control

Canadian radio frequency laws require a "break" (or interruption) of the transmission signals after broadcasting for a few seconds. Therefore, these signals may not last long enough for the integrated garage door opener. The signal is not recognized during programming. Comparable with Canadian law, some U.S. garage door openers also feature a "break".

Proceed as follows:

- if you live in Canada
- if you have difficulties programming the garage door opener (regardless of where you live) when using the programming steps
- ▶ Press and hold one of buttons ② to ④ on the integrated garage door opener. After a short time, indicator lamp ① lights up yellow.
- ▶ Release the button. Indicator lamp ① flashes yellow.
- ▶ Press button ⑥ of garage door remote control ⑤ for two seconds, then release it for two seconds.
- ▶ Press button ⑥ again for two seconds.
- ▶ Repeat this sequence on button ⑥ of remote control ⑤ until indicator lamp ① lights up green. When indicator lamp ① lights up green: programming is finished.

When indicator lamp ① flashes green: programming was successful. The next step is to synchronize the rolling code.

- ▶ Release button ⑥ of remote control ⑤ of the garage door drive.

If indicator lamp ① lights up red: repeat the programming process for the corresponding button on the rear-view mirror. When doing so, vary the distance between remote control ⑤ and the rear-view mirror.

The required distance between remote control ⑤ and the integrated garage door opener depends on the garage door drive system. Several attempts might be necessary. You should test every position for at least 25 seconds before trying another position.

### Problems when programming

If you are experiencing problems programming the integrated garage door opener on the rear-view mirror, take note of the following instructions:

- Check the transmitter frequency used by garage door drive remote control ⑤ and whether it is supported. The transmitter frequency can usually be found on the back of the garage door drive remote control. The integrated garage door opener is compatible with devices that have units which operate in the frequency range of 280 to 433 MHz.
- Replace the batteries in garage door remote control ⑤. This increases the likelihood that garage door remote control ⑤ will transmit a strong and precise signal to the integrated garage door opener.
- When programming, hold remote control ⑤ at varying distances and angles from the button which you are programming. Try various angles at a distance between 2 and 12 inches (5 to 30 cm) or at the same angle but at varying distances.
- If another remote control is available for the same garage door drive, repeat the same programming steps with this remote con-

trol. Before performing these steps, make sure that new batteries have been installed in garage door drive remote control ⑤.

- Note that some remote controls only transmit for a limited amount of time (the indicator lamp on the remote control goes out). Press button ⑥ on remote control ⑤ again before transmission ends.
- Align the antenna cable of the garage door opener unit. This can improve signal reception/transmission.

### Opening/closing the garage door

After it has been programmed, the integrated garage door opener performs the function of the garage door system remote control. Please also read the operating instructions for the garage door system.

- ▶ Turn the SmartKey to position **2** in the ignition lock (> page 135).
- ▶ Press button ②, ③ or ④ which you have programmed to operate the garage door. Garage door system with a fixed code: indicator lamp ① lights up green. Garage door system with a rolling code: indicator lamp ① flashes green. The transmitter will transmit a signal as long as the button is pressed. The transmission is halted after a maximum of ten seconds and indicator lamp ① lights up yellow.
- ▶ Press button ②, ③ or ④ again if necessary.

### Clearing the memory

Make sure that you clear the memory of the integrated garage door opener before selling the vehicle.

- ▶ Turn the SmartKey to position **2** in the ignition lock (▷ page 135).
- ▶ Press and hold buttons **②** and **④**.  
The indicator lamp initially lights up yellow and then green.
- ▶ Release buttons **②** and **④**.  
The memory of the integrated garage door opener in the rear-view mirror is cleared.

### Floormats

#### WARNING

Objects in the driver's footwell can restrict the pedal travel or obstruct a depressed pedal. The operating and road safety of the vehicle is jeopardized. There is a risk of an accident.

Make sure that all objects in the vehicle are stowed correctly, and that they cannot enter the driver's footwell. Install the floormats securely and as specified in order to ensure sufficient clearance for the pedals. Do not use loose floormats and do not place floormats on top of one another.

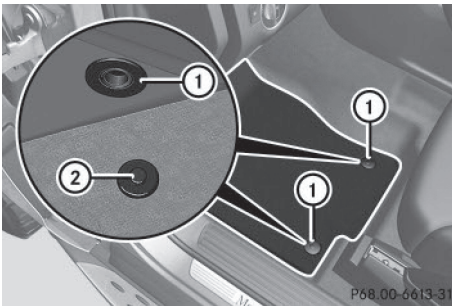

- ▶ **Driver's seat/front-passenger seat:** slide the respective seat back.
- ▶ **Rear seats:** slide the corresponding front seat forwards.
- ▶ **To install:** place the floormat in the footwell.
- ▶ Press studs **①** onto retainers **②**.
- ▶ **To remove:** pull the floormat from retainers **②**.
- ▶ Remove the floormat.

Useful information .....	266
Engine compartment .....	266
ASSYST PLUS .....	270
Care .....	270

### Useful information

- i** This Operator's Manual describes all models and all standard and optional equipment of your vehicle available at the time of publication of the Operator's Manual. Country-specific differences are possible. Please note that your vehicle may not be equipped with all features described. This also applies to safety-related systems and functions.
- i** Read the information on qualified specialist workshops (▷ page 35).

### Engine compartment

#### Hood

#### Important safety notes

##### WARNING

If the hood is unlatched, it may open up when the vehicle is in motion and block your view. There is a risk of an accident.  
Never unlatch the hood while driving. Before every trip, ensure that the hood is locked.

##### WARNING

When opening and closing the hood, it may suddenly fall into the closed position. There is a risk of injury to persons within range of movement of the hood.

Open and close the hood only when no one is within its range of movement.

##### WARNING

Opening the hood when the engine is overheated or when there is a fire in the engine compartment could expose you to hot gases or other service products. There is a risk of injury.

Let an overheated engine cool down before opening the hood. If there is a fire in the engine compartment, keep the hood closed and contact the fire department.

##### WARNING

The engine compartment contains moving components. Certain components, such as the radiator fan, may continue to run or start again suddenly when the ignition is off. There is a risk of injury.

If you need to do any work inside the engine compartment:

- switch off the ignition
- never reach into the area where there is a risk of danger from moving components, such as the fan rotation area
- remove jewelry and watches
- keep items of clothing and hair, for example, away from moving parts

##### WARNING

The ignition system and the fuel injection system work under high voltage. If you touch components which are under voltage, you could get an electric shock. There is a risk of injury.

Never touch components of the ignition system or fuel injection system when the ignition is switched on.

#### Opening the hood

##### WARNING

Certain components in the engine compartment, such as the engine, radiator and parts of the exhaust system, can become very hot. Working in the engine compartment poses a risk of injury.

Where possible, let the engine cool down and touch only the components described in the following.

##### WARNING

When the hood is open and the windshield wipers are set in motion, you can be injured by the wiper linkage. There is a risk of injury.

Always switch off the windshield wipers and the ignition before opening the hood.



**!** Make sure that the windshield wipers are not folded away from the windshield. You could otherwise damage the windshield wipers or the hood.

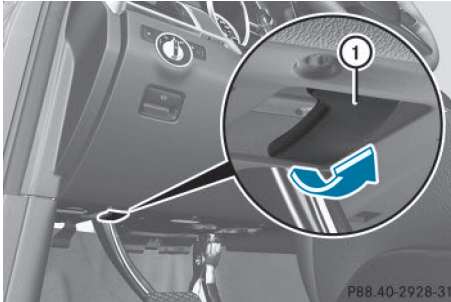

- ▶ Make sure that the windshield wipers are turned off.
- ▶ Pull release lever ① on the hood. The hood is released.

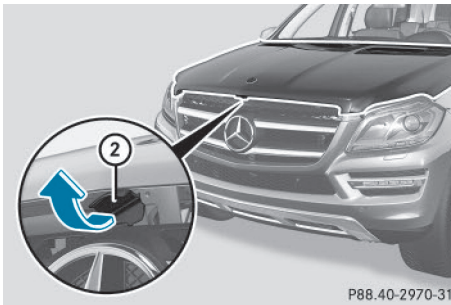

- ▶ Reach into the gap, pull hood catch handle ② up and lift the hood. If you lift the hood by approximately 15 in (40 cm), the hood is opened and held open automatically by the gas-filled strut.

### Closing the hood

- ▶ Lower the hood and let it fall from a height of approximately 8 in (20 cm).
- ▶ Check that the hood has engaged properly. If the hood can be raised slightly, it is not properly engaged. Open it again and close it with a little more force.

### Radiator

**Vehicles with a diesel engine:** do not cover the radiator, for example with a winter front or bug cover. The readings of the on-board-diagnostic system may otherwise be inaccurate. Some of these readings are required by law and must be accurate at all times.

### Engine oil

#### General notes

Depending on your driving style, the vehicle consumes up to 0.9 US qt (0.8 liters) of oil per 600 miles (1,000 km). The oil consumption may be higher than this when the vehicle is new or if you frequently drive at high engine speeds.

Depending on the engine, the oil dipstick may be in a different location.

When checking the oil level:

- park the vehicle on a level surface.
- the engine should be switched off for approximately five minutes if the engine is at normal operating temperature.
- if the engine is not at normal operating temperature, e.g. if the engine was only started briefly, wait about 30 minutes before carrying out the measurement.

#### Checking the oil level using the oil dipstick

##### WARNING

Certain components in the engine compartment, such as the engine, radiator and parts of the exhaust system, can become very hot. Working in the engine compartment poses a risk of injury.

Where possible, let the engine cool down and touch only the components described in the following.

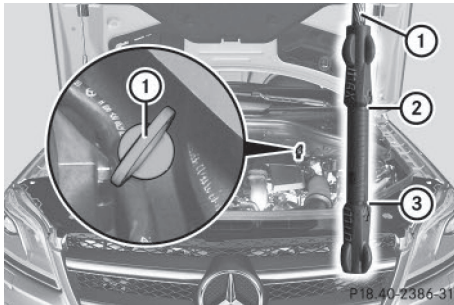

Example: vehicles with a gasoline engine

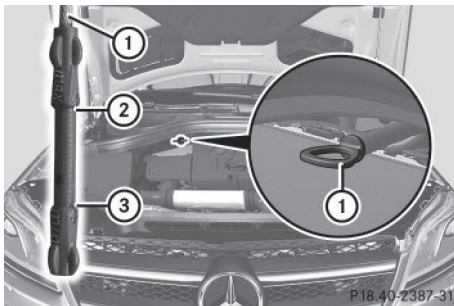

Example: vehicles with a diesel engine

- ▶ Pull oil dipstick ① out of the dipstick guide tube.
- ▶ Wipe off oil dipstick ①.
- ▶ Slowly slide oil dipstick ① into the guide tube to the stop, and take it out again. If the level is between MIN mark ③ and MAX mark ②, the oil level is correct.
- ▶ If the oil level has dropped to MIN mark ③ or below, add 1.1 US qt (1.0 liter) engine oil.

### Adding engine oil

#### **WARNING**

Certain components in the engine compartment, such as the engine, radiator and parts of the exhaust system, can become very hot. Working in the engine compartment poses a risk of injury.

Where possible, let the engine cool down and touch only the components described in the following.

#### **WARNING**

If engine oil comes into contact with hot components in the engine compartment, it may ignite. There is a risk of fire and injury.

Make sure that engine oil is not spilled next to the filler neck. Let the engine cool down and thoroughly clean the engine oil off the components before starting the engine.

#### **Environmental note**

When adding oil, take care not to spill any. If oil enters the soil or waterways, it is harmful to the environment.

- ❗ Only use engine oils and oil filters that have been approved for vehicles with a service system. You can obtain a list of the engine oils and oil filters tested and approved in accordance with the Mercedes-Benz Specifications for Service Products at any Mercedes-Benz Service center.

Damage to the engine or exhaust system is caused by the following:

- using engine oils and oil filters that have not been specifically approved for the service system
- replacing engine oil and oil filters after the interval for replacement specified by the service system has been exceeded
- using engine oil additives.

- ❗ Do not add too much oil. adding too much engine oil can result in damage to the engine or to the catalytic converter. Have excess engine oil siphoned off.



Example: engine oil cap

- ▶ Turn cap ① counter-clockwise and remove it.
- ▶ Add engine oil.  
If the oil level is at or below the MIN mark on the oil dipstick, add 1.1 US qt (1.0 l) of engine oil.
- ▶ Replace cap ① on the filler neck and tighten clockwise.  
Ensure that the cap locks into place securely.
- ▶ Check the oil level again with the oil dipstick (▷ page 267).

Further information on engine oil (▷ page 336).

### Additional service products

#### Checking coolant level

#### WARNING

Certain components in the engine compartment, such as the engine, radiator and parts of the exhaust system, can become very hot. Working in the engine compartment poses a risk of injury.

Where possible, let the engine cool down and touch only the components described in the following.

#### WARNING

The engine cooling system is pressurized, particularly when the engine is warm. When opening the cap, you could be scalded by hot coolant spraying out. There is a risk of injury.

Let the engine cool down before opening the cap. Wear eye and hand protection when opening the cap. Open the cap slowly half a turn to allow pressure to escape.

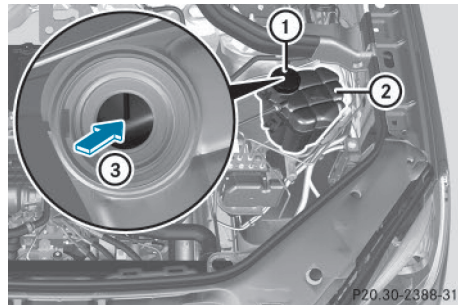

- ▶ Park the vehicle on a level surface.  
Only check the coolant level when the vehicle is on a level surface and the engine has cooled down.
- ▶ Turn the SmartKey to position **2** in the ignition lock (▷ page 135).  
On vehicles with KEYLESS-GO, press the Start/Stop button twice (▷ page 135).
- ▶ Check the coolant temperature gauge in the multifunction display.  
The coolant temperature must be below 158 °F (70 °C).
- ▶ Turn the SmartKey to position **0** in the ignition lock (▷ page 135).
- ▶ Slowly turn cap ① half a turn counter-clockwise and allow excess pressure to escape.
- ▶ Turn cap ① further counter-clockwise and remove it.  
If the coolant is at the level of marker bar ③ in the filler neck when cold, there is enough coolant in coolant expansion tank ②.  
If the coolant level is approximately 0.6 in (1.5 cm) above marker bar ③ in the filler neck when warm, there is enough coolant in expansion tank ②.
- ▶ If necessary, add coolant that has been tested and approved by Mercedes-Benz.
- ▶ Replace cap ① and turn it clockwise as far as it will go.

For further information on coolant, see (▷ page 338).

### Adding washer fluid to the windshield washer system

#### WARNING

Certain components in the engine compartment, such as the engine, radiator and parts of the exhaust system, can become very hot. Working in the engine compartment poses a risk of injury.

Where possible, let the engine cool down and touch only the components described in the following.

#### WARNING

Windshield washer concentrate could ignite if it comes into contact with hot engine components or the exhaust system. There is a risk of fire and injury.

Make sure that no windshield washer concentrate is spilled next to the filler neck.

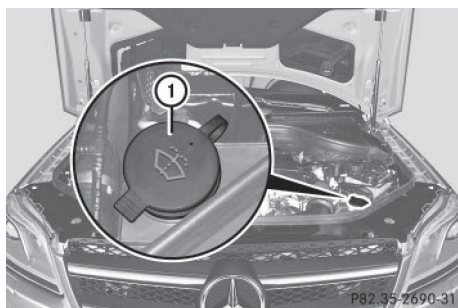

Example: washer fluid reservoir

- ▶ **To open:** pull cap ① upwards by the tab.
- ▶ Add the premixed washer fluid.
- ▶ **To close:** press cap ① onto the filler neck until it engages.

If the washer fluid level drops below the recommended minimum of 1 liter, a message appears in the multifunction display prompting you to add washer fluid.

Further information on windshield washer fluid (▷ page 339).

### ASSYST PLUS

The Digital Operator's Manual contains more information on the ASSYST PLUS service interval display.

### Care

#### General notes

##### Environmental note

Dispose of empty packaging and cleaning cloths in an environmentally responsible manner.

 For cleaning your vehicle, do not use any of the following:

- dry, rough or hard cloths
- abrasive cleaning agents
- solvents
- cleaning agents containing solvents

Do not scrub.

Do not touch the surfaces or protective films with hard objects, e.g. a ring or ice scraper. You could otherwise scratch or damage the surfaces and protective film.

 Do not park the vehicle for an extended period straight after cleaning it, particularly after having cleaned the wheels with wheel cleaner. Wheel cleaners could cause increased corrosion of the brake discs and brake pads/linings. For this reason, you should drive for a few minutes after cleaning. Braking heats the brake discs and the brake pads/linings, thus drying them. The vehicle can then be parked.

Regular care of your vehicle is a condition for retaining the quality in the long term.

Use care products and cleaning agents recommended and approved by Mercedes-Benz.

## Exterior care

### Automatic car wash

#### WARNING

Braking efficiency is reduced after washing the vehicle. There is a risk of an accident.

After the vehicle has been washed, brake carefully while paying attention to the traffic conditions until full braking power is restored.

**!** Before driving into an automatic car wash, make sure that it is suitable for the dimensions of the vehicle. In particular, make sure that:

- there is enough ground clearance between the vehicle underbody and the guide rails of the automatic car wash.
- the clearance width of the automatic car wash is sufficient, particularly the width of the guide rails.
- you enter the automatic car wash straight and in the center of the guide rails in order to avoid damaging the tires or wheel rims.

Fold in the exterior mirrors before the vehicle is washed. The exterior mirrors could otherwise be damaged.

**!** If DISTRONIC PLUS or the HOLD function is activated, the vehicle brakes automatically in certain situations.

To prevent damage to the vehicle, deactivate DISTRONIC PLUS and the HOLD function in the following or other similar situations:

- when towing the vehicle
- in the car wash

**!** Never clean your vehicle in a Touchless Automatic Car Wash as these use special cleaning agents. These cleaning agents can damage the paintwork or plastic parts.

**!** Make sure that:

- the side windows and the sliding sunroof are fully closed.
- the ventilation/heating is switched off (the OFF button has been pressed).
- the windshield wiper switch is in position **0**.

Otherwise, the vehicle might be damaged.

**!** In car washes with a towing mechanism, make sure that the automatic transmission is in transmission position **N**, otherwise the vehicle could be damaged.

- Vehicles with a SmartKey:

Do not remove the SmartKey from the ignition lock. Do not open the driver's door or front-passenger door when the engine is switched off. Otherwise, the automatic transmission selects park position **P** automatically and locks the wheels. You can prevent this by shifting the automatic transmission to **N** beforehand.

- Vehicles with KEYLESS-GO:

Do not open the driver's door or front-passenger door when the engine is switched off. Otherwise, the automatic transmission selects park position **P** automatically and locks the wheels.

Observe the following to make sure that the automatic transmission stays in position **N**:

- ▶ Make sure the vehicle is stationary and the ignition is switched off.
- ▶ Turn the SmartKey to position **2** in the ignition lock (> page 135). Use the SmartKey instead of the Start/Stop button on vehicles with KEYLESS-GO.
- ▶ Depress and hold the brake pedal.
- ▶ Shift the automatic transmission to position **N**.
- ▶ Release the brake pedal.
- ▶ Release the electric parking brake.
- ▶ Switch off the ignition and leave the SmartKey in the ignition lock.

You can wash the vehicle in an automatic car wash from the very start.

If the vehicle is very dirty, pre-wash it before cleaning it in an automatic car wash.

After using an automatic car wash, wipe off wax from the windshield and the wiper blades. This will prevent smears and reduce wiping noises caused by residue on the windshield.

- Cleaning the seat belts
- Cleaning the headliner and carpets

### Information in the Digital Operator's Manual

In the Digital Operator's Manual you will find information on the following topics:

- Washing by hand
- Power washers
- Cleaning the wheels
- Cleaning the paintwork
- Matte finish care
- Cleaning the windows
- Cleaning wiper blades
- Cleaning the exterior lighting
- Cleaning the mirror turn signals
- Cleaning the side running board
- Cleaning the sensors
- Cleaning the rear view camera
- Cleaning the 360° camera
- Cleaning the exhaust pipes
- Cleaning the trailer tow hitch

### Interior care

In the Digital Operator's Manual you will find information on the following topics:

- Cleaning the display
- Cleaning Night View Assist Plus
- Cleaning the plastic trim
- Cleaning the steering wheel and gear or selector lever
- Cleaning genuine wood and trim elements
- Cleaning the seat covers



Useful information .....	274
Where will I find...? .....	274
Flat tire .....	275
Battery (vehicle) .....	279
Jump-starting .....	283
Towing and tow-starting .....	285
Fuses .....	288



## Useful information

- i** This Operator's Manual describes all models and all standard and optional equipment of your vehicle available at the time of publication of the Operator's Manual. Country-specific differences are possible. Please note that your vehicle may not be equipped with all features described. This also applies to safety-related systems and functions.
- i** Read the information on qualified specialist workshops (▷ page 35).

## Breakdown assistance

## Where will I find...?

## Vehicle tool kit

## General notes

The vehicle tool kit can be found in the stowage well under the cargo compartment floor.

- i** Apart from certain country-specific variations, the vehicles are not equipped with a tire-change tool kit. Some tools for changing a wheel are specific to the vehicle. For more information on which tools are required to perform a wheel change on your vehicle, consult a qualified specialist workshop.

Tools required for changing a wheel may include, for example:

- Jack
- Wheel chock
- Lug wrench
- Ratchet wrench
- Alignment bolt

## Vehicles with a TIREFIT kit

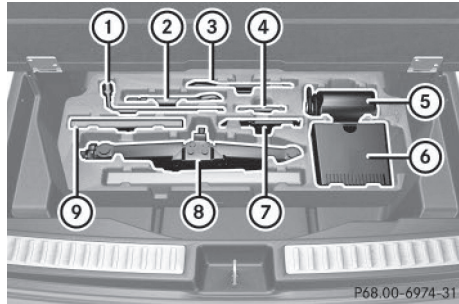

- ① Lug wrench
- ② Towing eye
- ③ Ratchet wrench
- ④ Alignment bolt
- ⑤ Tire sealant filler bottle
- ⑥ Tire inflation compressor
- ⑦ Folding wheel chock
- ⑧ Jack
- ⑨ Wheel bolts

- ▶ Lift the cargo compartment floor up (▷ page 254).
- ▶ Use the TIREFIT kit (▷ page 276).

## Vehicles with a "Minispare" emergency spare wheel

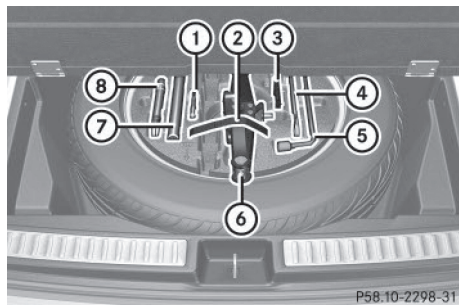

- ① Alignment bolt
- ② Velcro fastener
- ③ Folding wheel chock
- ④ Ratchet wrench
- ⑤ Lug wrench
- ⑥ Jack

- ⑦ Wheel bolts
- ⑧ Towing eye
- ▶ Lift the cargo compartment floor up (▷ page 254).

## Flat tire

### Preparing the vehicle

Your vehicle may be equipped with:

- MOExtended tires (tires with run-flat properties)
  - Vehicle preparation is not necessary on vehicles with MOExtended tires
- a TIREFIT kit
- an emergency spare wheel (only for certain countries)

Information on changing/mounting a wheel (▷ page 314).

- ▶ Stop the vehicle on solid, non-slippery and level ground, as far away as possible from traffic.
- ▶ Switch on the hazard warning lamps.
- ▶ Secure the vehicle against rolling away (▷ page 148).
- ▶ If possible, bring the front wheels into the straight-ahead position.
- ▶ **Vehicles with the AIRMATIC package:** make sure that highway level is selected (▷ page 165).
- ▶ **Vehicles with the ON&OFFROAD package:** make sure that highway level is selected (▷ page 162).
- ▶ Switch off the engine.
- ▶ **Vehicles without KEYLESS-GO:** remove the SmartKey from the ignition lock.
- ▶ **Vehicles with KEYLESS-GO:** open the driver's door.
  - The on-board electronics now have status **0**. This is the same as the SmartKey having been removed.

- ▶ **Vehicles with KEYLESS-GO:** remove the Start/Stop button from the ignition lock (▷ page 135).
- ▶ Make sure that the passengers are not endangered as they do so. Make sure that no one is near the danger area while a wheel is being changed. Anyone who is not directly assisting in the wheel change should, for example, stand behind the barrier.
- ▶ Get out of the vehicle. Pay attention to traffic conditions when doing so.
- ▶ Close the driver's door.
- ▶ Unload heavy luggage.

- ▶ **i** Only operate the tire inflation compressor using a 12 V socket, even if the ignition is turned off (▷ page 255).

An emergency cut-out ensures that the on-board voltage does not drop too low. If the on-board voltage is too low, the power to the sockets is automatically cut. This ensures that there is sufficient power to start the engine.

### MOExtended tires (tires with run-flat properties)

#### General notes

With MOExtended tires (tires with run flat characteristics), you can continue to drive your vehicle even if there is a total loss of pressure in one or more tires. The affected tire must not show any clearly visible damage. You can recognize MOExtended tires by the MOExtended marking which appears on the sidewall of the tire. You will find this marking next to the tire size designation, the load-bearing capacity and the speed index (▷ page 308).

MOExtended tires may only be used in conjunction with an active tire pressure loss warning system or with an active tire pressure monitor.

**If a pressure loss warning message appears in the multifunction display:**

- observe the instructions in the display messages (▷ page 211).
- check the tire for damage.
- if driving on, observe the following notes.

The driving distance possible in run-flat mode is approximately 50 miles (80 km) when the vehicle is partially laden and approximately 18 miles (30 km) when the vehicle is fully laden.

In addition to the vehicle load, the driving distance possible depends upon:

- vehicle speed
- road condition
- outside temperature

The driving distance possible in run-flat mode may be reduced by extreme driving conditions or maneuvers, or it can be increased through a moderate style of driving.

The driving distance possible in run-flat mode is counted from the moment the tire pressure loss warning appears in the multifunction display.

You must not exceed a maximum speed of 50 mph (80 km/h).

**i** When replacing one or all tires, please observe the following specifications for your vehicle's tires:

- size
- type and
- the "MOExtended" mark

If a tire has gone flat and cannot be replaced with a MOExtended tire, a standard tire may be used as a temporary measure. Make sure that you use the proper size and type (summer or winter tire).

**i** Vehicles equipped with MOExtended tires are not equipped with a TIREFIT kit at the factory. It is therefore recommended that you additionally equip your vehicle with a TIREFIT kit if you mount tires that do not feature run-flat properties, e.g. winter tires.

A TIREFIT kit may be obtained from a qualified specialist workshop.

**Important safety notes****⚠ WARNING**

When driving in emergency mode, the driving characteristics deteriorate, e.g. when cornering, accelerating quickly and when braking. There is a risk of an accident.

Do not exceed the stated maximum speed. Avoid abrupt steering and driving maneuvers, and driving over obstacles (curbs, potholes, off-road). This applies in particular to a laden vehicle.

Stop driving in emergency mode if:

- you hear banging noises.
- the vehicle starts to shake.
- you see smoke and smell rubber.
- ESP® is intervening constantly.
- there are tears in the sidewalls of the tire.

After driving in emergency mode, have the wheel rims checked at a qualified specialist workshop with regard to their further use. The defective tire must be replaced in every case.

**TIREFIT kit****Important safety notes**

TIREFIT is a tire sealant.

You can use TIREFIT to seal punctures of up to 0.16 in (4 mm), particularly those in the tire tread. You can use TIREFIT at outside temperatures down to -4 °F (-20 °C).

**⚠ WARNING**

In the following situations, the tire sealant is unable to provide sufficient breakdown assistance, as it is unable to seal the tire properly:

- there are cuts or punctures in the tire larger than those mentioned above.
- the wheel rim is damaged.
- you have driven at very low tire pressures or on a flat tire.

There is a risk of an accident.

Do not drive the vehicle. Contact a qualified specialist workshop.

### WARNING

The tire sealant is harmful and causes irritation. It must not come into contact with your skin, eyes or clothing or be swallowed. Do not inhale TIREFIT fumes. Keep tire sealant away from children. There is a risk of injury.

If you come into contact with the tire sealant, observe the following:

- Rinse off the tire sealant from your skin immediately with water.
- If the tire sealant comes into contact with your eyes, immediately rinse them thoroughly with clean water.
- If tire sealant is swallowed, immediately rinse your mouth out thoroughly and drink plenty of water. Do not induce vomiting, and seek medical attention immediately.
- Immediately change out of clothing which has come into contact with tire sealant.
- If an allergic reaction occurs, seek medical attention immediately.

**!** Do not operate the tire inflation compressor for longer than eight minutes at a time without a break. It may otherwise overheat. The tire inflation compressor can be operated again once it has cooled down.

Comply with the manufacturer's safety instructions on the sticker on the tire inflation compressor.

### Using the TIREFIT kit

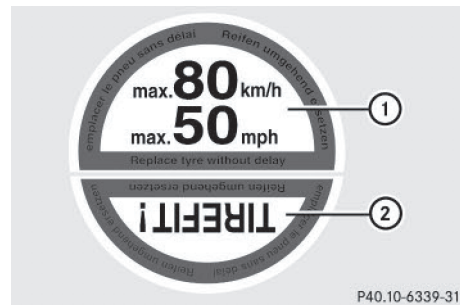

- ▶ Do not remove any foreign objects which have penetrated the tire, e.g. screws or nails.
- ▶ Remove the tire sealant bottle, the accompanying TIREFIT sticker and the tire inflation compressor from the stowage well underneath the cargo compartment floor (▷ page 274).
- ▶ Affix part ① of the TIREFIT sticker to the instrument cluster within the driver's field of vision.
- ▶ Affix part ② of the TIREFIT sticker near the valve on the wheel with the defective tire.

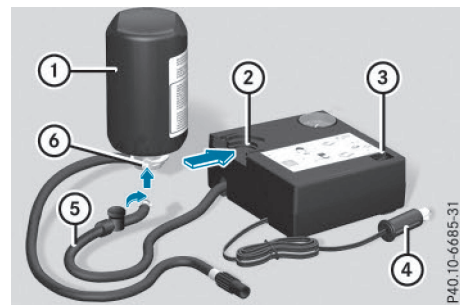

- ▶ Pull plug ④ with the cable and hose ⑤ out of the housing.
- ▶ Screw hose ⑤ onto flange ⑥ of tire sealant bottle ①.
- ▶ Place tire sealant bottle ① head downwards into recess ② of the tire inflation compressor.

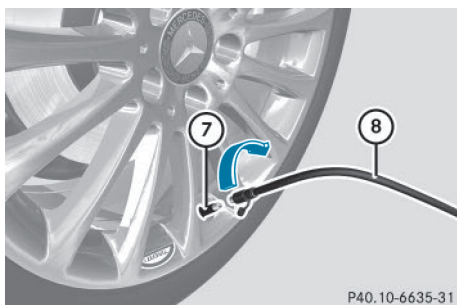

- ▶ Remove the cap from valve ⑦ on the faulty tire.
- ▶ Screw filler hose ⑧ onto valve ⑦.
- ▶ Insert plug ④ into the socket of the cigarette lighter or into a 12 V power socket in your vehicle.
- ▶ Turn the SmartKey to position 1 in the ignition lock (▷ page 135).
- ▶ Press on and off switch ③ on the tire inflation compressor to I.  
The tire inflation compressor is switched on. The tire is inflated.

**i** First, tire sealant is pumped into the tire. The pressure can briefly rise to approximately 500 kPa (5 bar/73 psi).

**Do not switch off the tire inflation compressor during this phase.**

- ▶ Allow the tire inflation compressor to run for five minutes. The tire should then have attained a pressure of at least 180 kPa (1.8 bar/26 psi).

If a pressure of 180 kPa (1.8 bar/26 psi) has been attained after five minutes, see "Tire pressure reached" (▷ page 278).

If a tire pressure of 180 kPa (1.8 bar/26 psi) has not been attained after five minutes, see "Tire pressure not reached" (▷ page 278).

If tire sealant leaks out, allow it to dry. It can then be removed like a layer of film.

If your clothes are soiled with tire sealant, have them cleaned with perchloroethylene at a dry cleaner as soon as possible.

### Tire pressure not reached

If a pressure of 180 kPa (1.8 bar/26 psi) has not been attained after five minutes:

- ▶ Switch off the tire inflation compressor.
- ▶ Unscrew the filler hose from the valve of the faulty tire.
- ▶ Very slowly drive forwards or reverse approximately 30 ft (10 m).
- ▶ Pump up the tire again.

After a maximum of five minutes the tire pressure must be at least 180 kPa (1.8 bar/26 psi).

#### **⚠ WARNING**

If the required tire pressure is not reached after the specified time, the tire is too badly damaged. The tire sealant cannot repair the tire in this instance. Damaged tires and a tire pressure that is too low can significantly impair the vehicle's braking and driving characteristics. There is a risk of accident.

Do not continue driving. Contact a qualified specialist workshop.

### Tire pressure reached

#### **⚠ WARNING**

A tire temporarily sealed with tire sealant impairs the driving characteristics and is not suitable for higher speeds. There is a risk of accident.

You should therefore adapt your driving style accordingly and drive carefully. Do not exceed the specified maximum speed with a tire that has been repaired using tire sealant.

The maximum speed for a tire sealed with tire sealant is 50 mph (80 km/h). The upper part of the TIREFIT sticker must be affixed to the instrument cluster in the driver's field of vision.

- !** Residue from the tire sealant may come out of the filler hose after use. This could cause stains.

Therefore, place the filler hose in the plastic bag which contained the TIREFIT kit.

#### Environmental note

Have the used tire sealant bottle disposed of professionally, e.g. at a qualified specialist workshop.

If a tire pressure of 180 kPa (1.8 bar/26 psi) has been attained after five minutes:

- ▶ Switch off the tire inflation compressor.
- ▶ Unscrew the filler hose from the valve of the faulty tire.
- ▶ Stow the tire sealant bottle and the tire inflation compressor.
- ▶ **Pull away immediately.**
- ▶ Stop after driving for approximately ten minutes and check the tire pressure with the tire inflation compressor. The tire pressure must now be at least 130 kPa (1.3 bar/19 psi).



#### WARNING

If the required tire pressure is not reached after driving for a short period, the tire is too badly damaged. The tire sealant cannot repair the tire in this instance. Damaged tires and a tire pressure that is too low can significantly impair the vehicle's braking and driving characteristics. There is a risk of accident.

Do not continue driving. Contact a qualified specialist workshop.

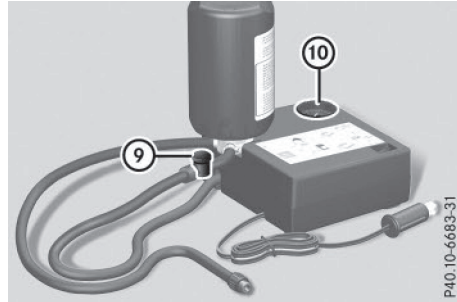
-  In cases such as the one mentioned above, contact an authorized Mercedes-Benz Center. Or call 1-800-FOR-MERCEdes (in the USA) or 1-800-387-0100 (in Canada).
- ▶ Correct the tire pressure if it is still at least 130 kPa (1.3 bar/19 psi). See the Tire and Loading Information placard on the driver's side B-pillar or the tire pressure table in the fuel filler flap for values.
- ▶ **To increase the tire pressure:** switch on the tire inflation compressor.



- ▶ **To reduce the tire pressure:** press pressure release button  on the filler hose.
- ▶ The tire pressure is shown on pressure gauge .
- ▶ When the tire pressure is correct, unscrew the filler hose from the valve of the sealed tire.
- ▶ Screw the valve cap onto the tire valve of the sealed tire.
- ▶ Pull the tire sealant bottle out of the tire inflation compressor. The filler hose remains attached to the tire sealant bottle.
- ▶ Drive to the nearest qualified specialist workshop and have the tire changed there.
- ▶ Have the tire sealant bottle replaced as soon as possible at a qualified specialist workshop.
- ▶ Have the tire sealant bottle replaced every four years at a qualified specialist workshop.

#### Battery (vehicle)

##### Important safety notes

Special tools and expert knowledge are required when working on the battery, e.g. removal and installation. You should therefore have all work involving the battery carried out at a qualified specialist workshop.



**⚠ WARNING**

Work carried out incorrectly on the battery can lead, for example, to a short circuit and thus damage the vehicle electronics. This can lead to function restrictions applying to safety-relevant systems, e.g the lighting system, the ABS (anti-lock braking system) or the ESP® (Electronic Stability Program). The operating safety of your vehicle may be restricted. You could lose control of the vehicle, for example:

- when braking
- in the event of abrupt steering maneuvers and/or when the vehicle's speed is not adapted to the road conditions

There is a risk of an accident.

In the event of a short circuit or a similar incident, contact a qualified specialist workshop immediately. Do not drive any further. You should have all work involving the battery carried out at a qualified specialist workshop.

- i** For further information about ABS and ESP®, see (▷ page 74) and (▷ page 79).

**⚠ WARNING**

Electrostatic build-up can lead to the creation of sparks, which could ignite the highly explosive gases of a battery. There is a risk of an explosion.

Before handling the battery, touch the vehicle body to remove any existing electrostatic build-up.

The highly flammable gas mixture forms when charging the battery as well as when jump-starting.

Always make sure that neither you nor the battery is electrostatically charged. A build-up of electrostatic charge can be caused, for example:

- by wearing clothing made from synthetic fibers
- due to friction between clothing and seats

- if you push or pull the battery across the carpet or other synthetic materials
- if you wipe the battery with a cloth

**⚠ WARNING**

During the charging process, a battery produces hydrogen gas. If a short circuit occurs or sparks are created, the hydrogen gas can ignite. There is a risk of an explosion.

- Make sure that the positive terminal of a connected battery does not come into contact with vehicle parts.
- Never place metal objects or tools on a battery.
- It is important that you observe the described order of the battery terminals when connecting and disconnecting a battery.
- When jump-starting, make sure that the battery poles with identical polarity are connected.
- It is particularly important to observe the described order when connecting and disconnecting the jumper cables.
- Never connect or disconnect the battery terminals while the engine is running.

**⚠ WARNING**

Battery acid is caustic. There is a risk of injury. Avoid contact with skin, eyes or clothing. Do not inhale any battery gases. Do not lean over the battery. Keep children away from batteries. Wash away battery acid immediately with plenty of clean water and seek medical attention.

**♻ Environmental note**

Batteries contain dangerous substances. It is against the law to dispose of them with the household rubbish. They must be collected separately and recycled to protect the environment.



Dispose of batteries in an environmentally friendly manner. Take discharged



batteries to a qualified specialist workshop or a special collection point for used batteries.

**!** Have the battery checked regularly at a qualified specialist workshop.

Observe the service intervals in the Maintenance Booklet or contact a qualified specialist workshop for more information.

**!** You should have all work involving the battery carried out at a qualified specialist workshop. In the exceptional case that it is necessary for you to disconnect the battery yourself, make sure that:

- you switch off the engine and remove the SmartKey. On vehicles with KEYLESS-GO, ensure that the ignition is switched off. Check that all the indicator lamps in the instrument cluster are off. Otherwise, electronic components, such as the alternator, may be damaged.
- you first remove the negative terminal clamp and then the positive terminal clamp. Never swap the terminal clamps. Otherwise, the vehicle's electronic system may be damaged.
- the transmission is locked in position **P** after disconnecting the battery. The vehicle is secured against rolling away. You can then no longer move the vehicle.

The battery and the cover of the positive terminal clamp must be installed securely during operation.

Comply with safety precautions and take protective measures when handling batteries.



Risk of explosion.



Fire, open flames and smoking are prohibited when handling the battery. Avoid creating sparks.



Battery acid is caustic. Avoid contact with skin, eyes or clothing.

Wear suitable protective clothing, especially gloves, apron and face-guard.

Rinse any acid spills immediately with clear water. Contact a physician if necessary.

Wear eye protection.



Keep children away.



Observe this Operator's Manual.

For safety reasons, Mercedes-Benz recommends that you only use batteries which have been tested and approved for your vehicle by Mercedes-Benz. These batteries provide increased impact protection to prevent vehicle occupants from suffering acid burns should the battery be damaged in the event of an accident.

In order for the battery to achieve the maximum possible service life, it must always be sufficiently charged.

The vehicle battery, like other batteries, can discharge over time if you do not use the vehicle. In this case, have the battery disconnected at a qualified specialist workshop. You can also charge the battery with a charger recommended by Mercedes-Benz. Contact a qualified specialist workshop for further information.

Have the battery condition of charge checked more frequently if you use the vehicle mainly for short trips or if you leave it standing idle for a lengthy period. Consult a qualified specialist workshop if you wish to leave your vehicle parked for a long period of time.

Remove the SmartKey if you park the vehicle and do not require any electrical consumers.

The vehicle will then use very little energy, thus conserving battery power.

**i** If the power supply has been interrupted, e.g. if you reconnect the battery, you will have to:

- set the clock. Information on setting the clock can be found in the Digital Operator's Manual.

On vehicles with COMAND and a navigation system, the clock is set automatically.

- reset the function for folding the exterior mirrors in/out automatically, by folding the mirrors out once (▷ page 112).

## Breakdown assistance

### Charging the battery

#### WARNING

During charging and jump-starting, explosive gases can escape from the battery. There is a risk of an explosion.

Particularly avoid fire, open flames, creating sparks and smoking. Ensure there is sufficient ventilation while charging and jump-starting. Do not lean over a battery.

#### WARNING

Battery acid is caustic. There is a risk of injury. Avoid contact with skin, eyes or clothing. Do not inhale any battery gases. Do not lean over the battery. Keep children away from batteries. Wash away battery acid immediately with plenty of clean water and seek medical attention.

#### WARNING

A discharged battery can freeze at temperatures below freezing point. When jump-starting the vehicle or charging the battery, gases can escape from the battery. There is a risk of an explosion.

Allow the frozen battery to thaw out before charging it or jump-starting.

**!** Only use battery chargers with a maximum charging voltage of 14.8 V.

**!** Only charge the battery using the jump-starting connection point.

If, at low temperatures, the indicator lamps/warning lamps in the instrument cluster do not light up, it is highly likely that the discharged battery has frozen. In this case you may neither jump-start the vehicle nor charge the battery. The service life of a thawed-out battery may be shorter. The starting characteristics can be impaired, particularly at low temperatures. Have the thawed-out battery checked at a qualified specialist workshop.

Never charge the battery if it is still installed in the vehicle, unless you use a battery charger which has been tested and approved by Mercedes-Benz. A battery charger unit specially adapted for Mercedes-Benz vehicles and tested and approved by Mercedes-Benz is available as an accessory. It permits the charging of the battery in its installed position. Contact an authorized Mercedes-Benz Center for further information and availability. Charge the battery in accordance with the separate instructions for the battery charger. The jump-starting connection point is in the engine compartment (▷ page 283).

Read the battery charger's operating instructions before charging the battery.

- ▶ Open the hood.
- ▶ Connect the battery charger to the positive terminal and ground point in the same order as when connecting the donor battery in the jump-starting procedure (▷ page 283).

## Jump-starting

For the jump-starting procedure, use only the jump-starting connection point, consisting of a positive terminal and a ground point, in the engine compartment.

### WARNING

Battery acid is caustic. There is a risk of injury.

Avoid contact with skin, eyes or clothing. Do not inhale any battery gases. Do not lean over the battery. Keep children away from batteries. Wash away battery acid immediately with plenty of clean water and seek medical attention.

### WARNING

During charging and jump-starting, explosive gases can escape from the battery. There is a risk of an explosion.

Particularly avoid fire, open flames, creating sparks and smoking. Ensure there is sufficient ventilation while charging and jump-starting. Do not lean over a battery.

### WARNING

During the charging process, a battery produces hydrogen gas. If a short circuit occurs or sparks are created, the hydrogen gas can ignite. There is a risk of an explosion.

- Make sure that the positive terminal of a connected battery does not come into contact with vehicle parts.
- Never place metal objects or tools on a battery.
- It is important that you observe the described order of the battery terminals when connecting and disconnecting a battery.
- When jump-starting, make sure that the battery poles with identical polarity are connected.
- It is particularly important to observe the described order when connecting and disconnecting the jumper cables.
- Never connect or disconnect the battery terminals while the engine is running.

### WARNING

A discharged battery can freeze at temperatures below freezing point. When jump-starting the vehicle or charging the battery, gases can escape from the battery. There is a risk of an explosion. Allow the frozen battery to thaw out before charging it or jump-starting.

**!** **Vehicles with a gasoline engine:** avoid repeated and lengthy starting attempts. Otherwise, the catalytic converter could be damaged by non-combusted fuel.

If the indicator/warning lamps do not light up at low temperatures, it is very likely that the discharged battery has frozen. In this case you may neither jump-start the vehicle nor charge the battery. The service life of a thawed-out battery may be shorter. The starting characteristics can be impaired, particularly at low temperatures. Have the thawed-out battery checked at a qualified specialist workshop.

Do not start the vehicle using a rapid charging device. If your vehicle's battery is discharged, the engine can be jump-started from another vehicle or from a second battery using jumper cables. Observe the following points:

- The battery is not accessible in all vehicles. If the other vehicle's battery is not accessible, jump-start the vehicle using a second battery or a jump-starting device.
- **Vehicles with a gasoline engine:** only jump-start the vehicle when the engine and exhaust system are cold.
- Do not start the engine if the battery is frozen. Let the battery thaw first.
- Only jump-start from batteries with a 12 V voltage rating.
- Only use jumper cables which have a sufficient cross-section and insulated terminal clamps.
- If the battery is fully discharged, leave the battery that is being used to jump-start connected for a few minutes before attempting to start. This charges the battery slightly.
- Make sure that the two vehicles do not touch.

Make sure that:

- The jumper cables are not damaged.
- Bare parts of the terminal clamp do not come into contact with other metal parts while the jumper cables are connected to the battery.
- The jumper cables cannot come into contact with parts which can move when the engine is running, such as the V-belt pulley or the fan.
- ▶ Secure the vehicle by applying the electric parking brake.
- ▶ Shift the transmission to position **P**.
- ▶ Turn the SmartKey to position **0** in the ignition lock and remove it (▷ page 135). On vehicles with KEYLESS-GO, make sure the ignition is switched off (▷ page 135). All indicator lamps in the instrument cluster must be off.
- ▶ Switch off all electrical consumers, e.g. rear window defroster, lighting, etc.
- ▶ Open the hood.

### Breakdown assistance

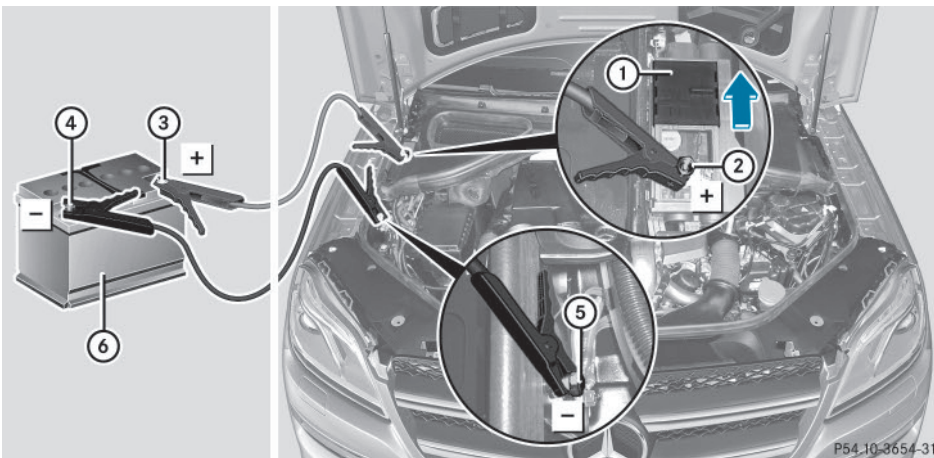

(Example)

Position number ⑥ identifies the charged battery of the other vehicle or an equivalent jump-starting device.

- ▶ Slide cover ① of positive terminal ② in the direction of the arrow.
- ▶ Connect positive terminal ② on your vehicle to positive terminal ③ of donor battery ⑥ using the jumper cable, always begin with positive terminal ② on your own vehicle first.
- ▶ Start the engine of the donor vehicle and run it at idling speed.
- ▶ Connect negative terminal ④ of donor battery ⑥ to ground point ⑤ of your vehicle using the jumper cable, connecting the jumper cable to battery of other vehicle ⑥ first.
- ▶ Start the engine.
- ▶ Before disconnecting the jumper cables, let the engine run for several minutes.
- ▶ First, remove the jumper cables from ground point ⑤ and negative terminal ④, then from positive clamp ② and positive terminal ③. Begin each time at the contacts on your own vehicle first.
- ▶ Close cover ① of positive terminal ② after removing the jumper cables.
- ▶ Have the battery checked at a qualified specialist workshop.

Jump-starting is not considered to be a normal operating condition.

- i** Jumper cables and further information regarding jump-starting can be obtained at any qualified specialist workshop.

## Towing and tow-starting

### Important safety notes

#### WARNING

Functions relevant to safety are restricted or no longer available if:

- the engine is not running.
- the brake system or the power steering is malfunctioning.
- there is a malfunction in the voltage supply or the vehicle's electrical system.

If your vehicle is being towed, much more force may be necessary to steer or brake. There is a risk of an accident.

In such cases, use a tow bar. Before towing, make sure that the steering moves freely.

#### WARNING

You can no longer steer the vehicle if the steering wheel lock has been engaged. There is a risk of an accident.

Always switch off the ignition when towing the vehicle with a tow cable or a tow bar.

#### WARNING

When towing or tow-starting another vehicle and its weight is greater than the permissible gross weight of your vehicle, the:

- the towing eye could detach itself
- the vehicle/trailer combination could roll-over.

There is a risk of an accident.

When towing or tow-starting another vehicle, its weight should not be greater than the permissible gross weight of your vehicle.

- i** Details on the permissible gross vehicle weight of your vehicle can be found on the vehicle identification plate (▷ page 332).

- !** If DISTRONIC PLUS or the HOLD function is activated, the vehicle brakes automatically in certain situations.

To prevent damage to the vehicle, deactivate DISTRONIC PLUS and the HOLD function in the following or other similar situations:

- when towing the vehicle
- in the car wash

**!** Make sure that the electric parking brake is released. If the electric parking brake is faulty, visit a qualified specialist workshop.

**!** Only secure the tow rope or tow bar at the towing eyes. Otherwise, the vehicle could be damaged.

**!** Do not use the trailer tow hitch for recovery or towing. Do not use the towing eye for recovery. This could damage the vehicle. If in doubt, have the vehicle recovered using a crane.

**!** When towing, pull away slowly and smoothly. Pull the towed vehicle as straight as possible and not at an acute angle. Excessive tractive power could damage the vehicles.

**i** When towing, it is preferable to use a rigid towing bar as opposed to a tow rope. A rigid towing bar helps to keep the tractive power low.

**!** When towing vehicles with KEYLESS-GO, use the key instead of the Start/Stop button. Otherwise, the automatic transmission may shift to position **P** when the driver's or front-passenger door are opened, which could lead to damage to the transmission.

**!** Do not tow with sling-type equipment. This could damage the vehicle.

**!** Vehicles with differential locks: make sure the differential locks are in automatic mode. When towing, the differential locks must not be switched on. The transmission may otherwise be damaged.

**!** The vehicle can be towed a maximum of 30 miles (50km). The towing speed of 30 mph (50 km/h) must not be exceeded.

If the vehicle has to be towed more than 30 miles (50km), the entire vehicle must be raised and transported.

It is better to have the vehicle transported than to have it towed away.

If the vehicle has suffered transmission damage, have it transported on a transporter or trailer.

The automatic transmission must be in position **N** when the vehicle is being towed.

The battery must be connected and charged. Otherwise, you:

- cannot turn the SmartKey to position **2** in the ignition lock
- cannot release the electric parking brake
- cannot shift the automatic transmission to position **N**

**i** Disarm the automatic locking feature (▷ page 199). You could otherwise be locked out when pushing or towing the vehicle.

### Installing/removing the towing eye

#### Installing the towing eye



P88.20-3757-31

Example: towing eye mounting covers

The brackets for the screw-in towing eyes are located in the bumpers. They are at the front and at the rear, behind the covers.

- ▶ Remove the towing eye from the vehicle tool kit (▷ page 274).
- ▶ **To open the cover at the front:** press the mark on cover ① inwards in the direction of the arrow.
- ▶ **To open the cover at the rear:** insert a flat, blunt object into the cutout and lever cover ② out of the bumper.
- ▶ Take cover ① or ② off the opening.
- ▶ Screw in the towing eye clockwise as far as it will go and tighten it.

### Removing the towing eye

- ▶ Unscrew and remove the towing eye.
- ▶ Attach cover ① or ② to the bumper and press until it engages.
- ▶ Place the towing eye in the vehicle tool kit.

### Towing a vehicle with both axles on the ground

It is important that you observe the safety instructions when towing away your vehicle (▷ page 285).

The automatic transmission automatically shifts to position **P** when you open the driver's or front-passenger door or when you remove the SmartKey from the ignition lock.

In order to ensure that the automatic transmission stays in position **N** when towing the vehicle, you must observe the following points:

- ▶ Make sure that the vehicle is stationary and the SmartKey in the ignition lock is in position **0**.
- ▶ Turn the SmartKey to position **2** in the ignition lock.

On vehicles with KEYLESS-GO, use the SmartKey instead of the Start/Stop button (▷ page 135).

- ▶ Depress and hold the brake pedal.
- ▶ Shift the automatic transmission to position **N**.
- ▶ Release the brake pedal.
- ▶ Release the electric parking brake.
- ▶ Leave the SmartKey in position **2** in the ignition lock.
- ▶ Switch on the hazard warning lamps (▷ page 114).

**i** In order to signal a change of direction when towing the vehicle with the hazard warning lamps switched on, use the combination switch as usual. In this case, only the indicator lamps for the direction of travel flash. After resetting the combination switch, the hazard warning lamp starts flashing again.

### Transporting the vehicle

**!** You may only secure the vehicle by the wheels, not by parts of the vehicle such as axle or steering components. Otherwise, the vehicle could be damaged.

The towing eye can be used to pull the vehicle onto a trailer or transporter for transporting purposes.

- ▶ Turn the SmartKey to position **2** in the ignition lock.
- ▶ Shift the automatic transmission to position **N**.

### As soon as the vehicle has been loaded:

- ▶ Prevent the vehicle from rolling away by applying the electric parking brake.
- ▶ Shift the automatic transmission to position **P**.
- ▶ Turn the SmartKey to position **0** in the ignition lock and remove it.
- ▶ Secure the vehicle.



**Information on 4MATIC vehicles**

**!** Vehicles with 4MATIC must not be towed with either the front or the rear axle raised, as doing so will damage the transmission.

If the vehicle has transmission damage or damage to the front or rear axle, have it transported on a transporter or trailer.

**In the event of damage to the electrical system**

If the battery is defective, the automatic transmission will be locked in position **P**. To shift the automatic transmission to position **N**, you must provide power to the vehicle's electrical system in the same way as when jump-starting (▷ page 283).

Have the vehicle transported on a transporter or trailer.

**Tow-starting (emergency engine starting)**

**!** Vehicles with automatic transmission must not be tow-started. You could otherwise damage the automatic transmission.

**i** You can find information on "Jump-starting" under (▷ page 283).

**Fuses****Important safety notes****⚠ WARNING**

If you manipulate or bridge a faulty fuse or if you replace it with a fuse with a higher amperage, the electric cables could be overloaded. This could result in a fire. There is a risk of an accident and injury.

Always replace faulty fuses with the specified new fuses having the correct amperage.

**!** For the fuse boxes in the engine compartment and under the rear bench seat, only use fuses with the suffix "S". Otherwise, components or systems could be damaged.

The fuses in your vehicle serve to close down faulty circuits. If a fuse blows, all the components on the circuit and their functions stop operating.

Blown fuses must be replaced with fuses of the same rating, which you can recognize by the color and value. The fuse ratings are listed in the fuse allocation chart.

If a newly inserted fuse also blows, have the cause traced and rectified at a qualified specialist workshop, e.g. an authorized Mercedes-Benz Center.

**Before changing a fuse**

Observe the important safety notes (▷ page 288)

- ▶ Secure the vehicle against rolling away (▷ page 148).
- ▶ Switch off the engine.
- ▶ Switch off all electrical consumers.
- ▶ Remove the SmartKey from the ignition lock.

or, on vehicles with KEYLESS-GO:

- ▶ Open the driver's door.  
The on-board electronics now have status **0**. This is the same as the SmartKey having been removed.

All indicator lamps in the instrument cluster must be off.

The fuses are located in various fuse boxes:

- Fuse box on the front-passenger side of the dashboard
- Fuse box in the engine compartment on the right-hand side of the vehicle, when viewed in the direction of travel
- Fuse box under the rear bench seat

The fuse allocation chart is located in the fuse box under the rear bench seat (▷ page 289).

**Dashboard fuse box**

Pay attention to the important safety notes (▷ page 288).

❗ Do not use a pointed object such as a screwdriver to open the cover in the dashboard. You could damage the dashboard or the cover.

❗ Make sure that no moisture can enter the fuse box when the cover is open.

❗ When closing the cover, make sure that it is lying correctly on the fuse box. Moisture seeping in or dirt could otherwise impair the operation of the fuses.

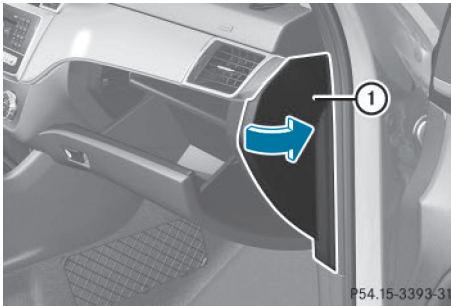

- ▶ Open the front-passenger door.
- ▶ **To open:** pull cover ① outwards in the direction of the arrow and remove it.
- ▶ **To close:** clip in cover ① on the front of the dashboard.
- ▶ Fold cover ① inwards until it engages.

### Fuse box in the engine compartment

Pay attention to the important safety notes (> page 288).

#### ⚠ WARNING

When the hood is open and the windshield wipers are set in motion, you can be injured by the wiper linkage. There is a risk of injury.

Always switch off the windshield wipers and the ignition before opening the hood.

❗ Make sure that no moisture can enter the fuse box when the cover is open.

❗ When closing the cover, make sure that it is lying correctly on the fuse box. Moisture

seeping in or dirt could otherwise impair the operation of the fuses.

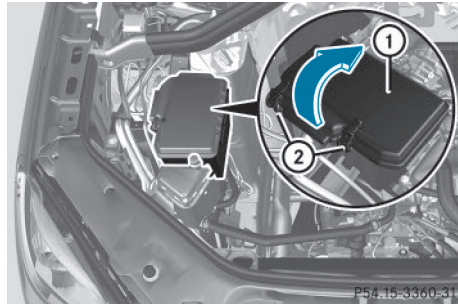

- ▶ Open the hood.
- ▶ Use a dry cloth to remove any moisture from the fuse box.
- ▶ **To open:** open clamps ②.
- ▶ Fold up cover ① in the direction of the arrow and remove it.
- ▶ **To close:** check whether the seal is seated correctly in cover ①.
- ▶ Insert cover ① at the side of the fuse box into the retainers.
- ▶ Fold down cover ① and close clamps ②.
- ▶ Close the hood.

### Fuse box under the rear bench seat

Pay attention to the important safety notes (> page 288).

❗ Make sure that no moisture can enter the fuse box when the cover is open.

❗ When closing the cover, make sure that it is lying correctly on the fuse box. Moisture seeping in or dirt could otherwise impair the operation of the fuses or the cover could be damaged by the rear bench seat.

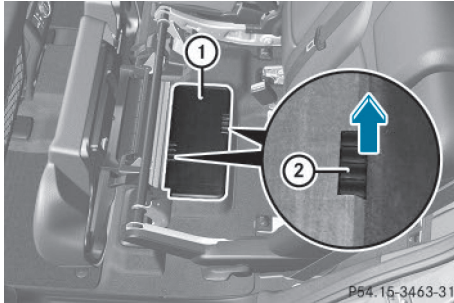

- ▶ Fold the left-hand rear bench seat forward (▷ page 250).
- ▶ **To open:** reach into recesses (2) on each side of fuse box cover (1).
- ▶ Fold cover (1) up in the direction of the arrow and remove it from the fuse box.
- ▶ **i** The fuse allocation chart is located in a recess at the side of the fuse box.
- ▶ **To close:** place cover (1) on the fuse box.
- ▶ Press cover (1) down until you feel the clamps engage.
- ▶ Fold back the left-hand rear bench seat (▷ page 250).

Useful information .....	292
Important safety notes .....	292
Operation .....	292
Winter operation .....	294
Tire pressure .....	295
Loading the vehicle .....	303
All about wheels and tires .....	306
Changing a wheel .....	314
Wheel and tire combinations .....	319
Emergency spare wheel .....	325

### Useful information

- i** This Operator's Manual describes all models and all standard and optional equipment of your vehicle available at the time of publication of the Operator's Manual. Country-specific differences are possible. Please note that your vehicle may not be equipped with all features described. This also applies to safety-related systems and functions.
- i** Read the information on qualified specialist workshops (▷ page 35).

### Important safety notes

#### WARNING

If wheels and tires of the wrong size are used, the wheel brakes or suspension components may be damaged. There is a risk of an accident.

Always replace wheels and tires with those that fulfill the specifications of the original part.

When replacing wheels, make sure to use the correct:

- designation
- model

When replacing tires, make sure to use the correct:

- designation
- manufacturer
- model

#### WARNING

A flat tire severely impairs the driving, steering and braking characteristics of the vehicle. There is a risk of accident.

Tires without run-flat characteristics:

- do not drive with a flat tire.
- immediately replace the flat tire with your emergency spare wheel or spare wheel, or consult a qualified specialist workshop.

Tires with run-flat characteristics:

- pay attention to the information and warning notices on MOExtended tires (tires with run-flat characteristics).

Accessories that are not approved for your vehicle by Mercedes-Benz or that are not being used correctly can impair operating safety.

Before purchasing and using non-approved accessories, visit a qualified specialist workshop and inquire about:

- suitability
- legal stipulations
- factory recommendations

Information on the sizes and types of wheels and tires for your vehicle can be found under "Wheel/tire combinations" (▷ page 319).

Tire pressure information can be found:

- on the vehicle's Tire and Loading Information placard on the B-pillar
- on the tire pressure label on the fuel filler flap
- in the "Tire pressure" section

## Operation

### Information on driving

Check the tire pressure when the vehicle is heavily laden and adjust prior to a trip.

While driving, pay attention to vibrations, noises and unusual handling characteristics, e.g. pulling to one side. This may indicate that the wheels or tires are damaged. If you suspect that a tire is defective, reduce your speed immediately. Stop the vehicle as soon as possible to check the wheels and tires for damage. Hidden tire damage could also be causing the unusual handling characteristics. If you find no signs of damage, have the tires and wheels checked at a qualified specialist workshop.

When parking your vehicle, make sure that the tires do not get deformed by the curb or

other obstacles. If it is necessary to drive over curbs, speed humps or similar elevations, try to do so slowly and at an obtuse angle. Otherwise, the tires, particularly the sidewalls, may be damaged.

### Regular checking of wheels and tires

#### WARNING

Damaged tires can cause tire inflation pressure loss. As a result, you could lose control of your vehicle. There is a risk of accident.

Check the tires regularly for signs of damage and replace any damaged tires immediately.

Regularly check the wheels and tires of your vehicle for damage at least once a month, as well as after driving off-road or on rough roads. Damaged wheels can cause a loss of tire pressure. Pay particular attention to damage such as:

- cuts in the tires
- punctures
- tears in the tires
- bulges on tires
- deformation or severe corrosion on wheels

Regularly check the tire tread depth and the condition of the tread across the whole width of the tire (▷ page 293). If necessary, turn the front wheels to full lock in order to inspect the inner side of the tire surface.

All wheels must have a valve cap to protect the valve against dirt and moisture. Do not mount anything onto the valve other than the standard valve cap or other valve caps approved by Mercedes-Benz for your vehicle. Do not use any other valve caps or systems, e.g. tire pressure monitoring systems.

Regularly check the pressure of all the tires particularly prior to long trips. Adjust the tire pressure as necessary (▷ page 295).

Observe the notes on the emergency spare wheel (▷ page 325).

The service life of tires depends, among other things, on the following factors:

- Driving style
- Tire pressure
- Distance covered

### Notes on tire tread

#### WARNING

Insufficient tire tread will reduce tire traction. The tire is no longer able to dissipate water. This means that on wet road surfaces, the risk of hydroplaning increases, in particular where speed is not adapted to suit the driving conditions. There is a risk of accident.

If the tire pressure is too high or too low, tires may exhibit different levels of wear at different locations on the tire tread. Thus, you should regularly check the tread depth and the condition of the tread across the entire width of all tires.

Minimum tire tread depth for:

- Summer tires:  $\frac{1}{8}$  in (3 mm)
- M+S tires:  $\frac{1}{6}$  in (4 mm)

For safety reasons, replace the tires before the legally prescribed limit for the minimum tire tread depth is reached.

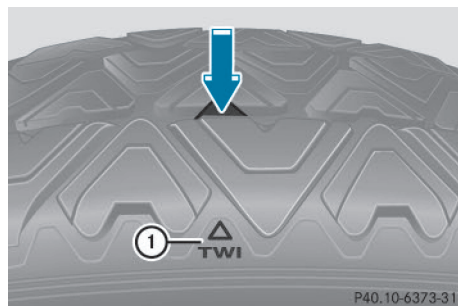

Marking ① shows where the bar indicator (arrow) for tread wear is integrated into the tire tread.

Treadwear indicators (TWI) are required by law. Six indicators are positioned on the tire tread. They are visible once a tread depth of

approximately  $\frac{1}{16}$  in (1.6 mm) has been reached. If this is the case, the tire is so worn that it must be replaced.

### Selecting, mounting and replacing tires

- Only mount tires and wheels of the same type and make.  
Exception: it is permissible to install a different type or make in the event of a flat tire. Observe here the "MOExtended tires (tires with run-flat characteristics)" section (▷ page 275).
- Only mount tires of the correct size onto the wheels.
- Break in new tires at moderate speeds for the first 60 miles (100 km). They only reach their full performance after this distance.
- Do not drive with tires which have too little tread depth, as this significantly reduces the traction on wet roads (hydroplaning).
- Replace the tires after six years at the latest, regardless of wear.

Observe the notes on the emergency spare wheel (▷ page 325).

### MOExtended tires (tires with run-flat properties)

With MOExtended tires (tires with run flat characteristics), you can continue to drive your vehicle even if there is a total loss of pressure in one or more tires.

MOExtended tires may only be used in conjunction with an active tire pressure loss warning system or with an active tire pressure monitor and on wheels specifically tested by Mercedes-Benz.

Notes on driving with MOExtended tires with a flat tire (▷ page 275).

- **i** Vehicles equipped with MOExtended tires are not equipped with a TIREFIT kit at the factory. It is therefore recommended that you additionally equip your vehicle with a

TIREFIT kit if you mount tires that do not feature run-flat properties, e.g. winter tires. A TIREFIT kit can be obtained from a qualified specialist workshop.

## Winter operation

### General notes

You can find information about this in the Digital Operator's Manual.

### Driving with summer tires

At temperatures below 45 °F (+7 °C), summer tires lose elasticity and therefore traction and braking power. Change the tires on your vehicle to M+S tires. Using summer tires at very cold temperatures could cause cracks to form, thereby damaging the tires permanently. Mercedes-Benz cannot accept responsibility for this type of damage.

### WARNING

Damaged tires can cause tire inflation pressure loss. As a result, you could lose control of your vehicle. There is a risk of accident.

Check the tires regularly for signs of damage and replace any damaged tires immediately.

### M+S tires

### WARNING

M+S tires with a tire tread depth of less than  $\frac{1}{8}$  in (4 mm) are not suitable for use in winter and do not provide sufficient traction. There is a risk of an accident.

M+S tires with a tread depth of less than  $\frac{1}{8}$  in (4 mm) must be replaced immediately.

Further information can be found in the Digital Operator's Manual.



## Snow chains

### WARNING

If snow chains are installed to the front wheels, they may drag against the vehicle body or chassis components. This could cause damage to the vehicle or the tires. There is a risk of an accident.

To avoid hazardous situations:

- never install snow chains to the front wheels
- always install snow chains in pairs to the rear wheels.

Further information can be found in the Digital Operator's Manual.

## Tire pressure

### Tire pressure specifications

#### Important safety notes

### WARNING

Underinflated or overinflated tires pose the following risks:

- the tires may burst, especially as the load and vehicle speed increase.
- the tires may wear excessively and/or unevenly, which may greatly impair tire traction.
- the driving characteristics, as well as steering and braking, may be greatly impaired.

There is a risk of an accident.

Follow recommended tire inflation pressures and check the pressure of all the tires including the spare wheel:

- monthly, at least
- if the load changes
- before beginning a long journey
- under different operating conditions, e.g. off-road driving

If necessary, correct the tire pressure.

- i** The specifications on the sample Tire and Loading Information placard and tire pressure tables are examples. Tire pressure specifications are vehicle-specific and may deviate from the data shown here. The tire pressure specifications that are valid for your vehicle can be found on the Tire and Loading Information placard and tire pressure table on the vehicle.

### General notes

The recommended tire pressures for the tires mounted at the factory can be found on the labels described here.

**Operation with an emergency spare wheel:** information on operation with an emergency spare wheel can be found in the general notes in the "Emergency spare wheel" section (▷ page 325).

**Operation with a trailer:** the applicable value for the rear tires is the maximum tire pressure value stated in the table inside the fuel filler flap.

Further information on tire pressures can be obtained at a qualified specialist workshop.

### Tire and Loading Information placard

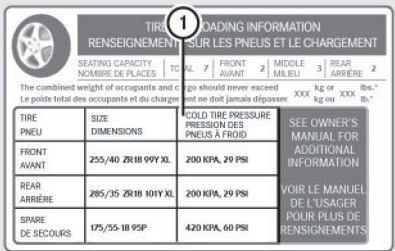

The placard contains the following information:

TIRE / PNEU	SIZE / DIMENSIONS	COLD TIRE PRESSURE / PRESSION DES PNEUS À FROID	SEE OWNER'S MANUAL FOR ADDITIONAL INFORMATION / VOIR LE MANUEL DE L'USAGER POUR PLUS DE RENSEIGNEMENTS
FRONT / AVANT	255/40 ZR18 99Y XL	200 KPA, 29 PSI	
REAR / ARRIÈRE	285/35 ZR18 101Y XL	200 KPA, 29 PSI	
SPARE / DE SECOURS	175/55-18 95P	420 KPA, 60 PSI	

Additional text on the placard includes: SEATING CAPACITY / NOMBRE DE PLACES, TIRE LOADING INFORMATION / RENSEIGNEMENTS SUR LES PNEUS ET LE CHARGEMENT, and weight limits in kg and lbs.

P40.00-2223-31

- ①** Recommended tire pressures

The Tire and Loading Information placard is on the B-pillar on the driver's side (▷ page 303).

The Tire and Loading Information placard contains the recommended tire pressures for cold tires. The recommended tire pressures

are valid for the maximum permissible load and up to the maximum permissible vehicle speed.

### Tire pressure table

The tire pressure table is on the inside of the fuel filler flap.

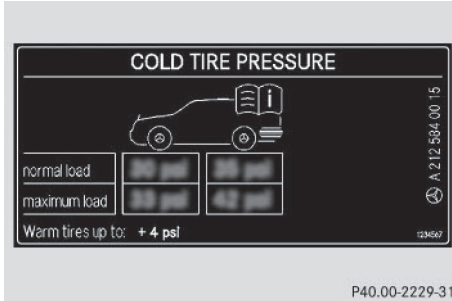

Example: tire pressure table for all tires permitted for this vehicle by the factory

The tire pressure table contains the recommended pressures for cold tires for various operating conditions, i.e. differing load and speed conditions.

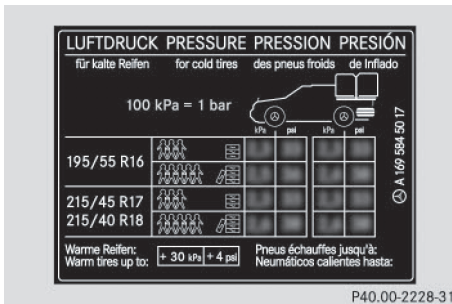

Example: tire pressure table with tire dimensions

If a tire size precedes a tire pressure, the tire pressure information following is only valid for that tire size. The load conditions "partially laden" and "fully laden" are defined in the table for different numbers of occupants and amounts of luggage. The actual number of seats may differ.

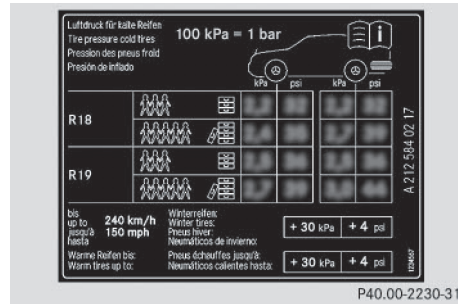

Some tire pressure tables show only the rim diameters instead of the full tire size, e.g. **R18**. Rim diameter is part of the tire size and can be found on the tire sidewall (▷ page 308).

If the tire pressures have been set to the lower values for lighter loads and/or lower road speeds, the pressures should be reset to the higher values:

- if you want to drive with an increased load and/or
- if you want to drive at higher road speeds

**i** The tire pressures for increased loads and/or higher road speeds, shown in the tire pressure table, may have a negative effect on driving comfort.

If the tire pressure is not set correctly, this can lead to an excessive build-up of heat and a sudden loss of pressure.

For more information, contact a qualified specialist workshop.

### Important notes on tire pressure

#### **⚠ WARNING**

If the tire pressure drops repeatedly, the wheel, valve or tire may be damaged. Tire pressure that is too low may result in a tire blow-out. There is a risk of an accident.

- Check the tire for foreign objects.
- Check whether the wheel is losing air or the valve is leaking.

If you are unable to rectify the damage, contact a qualified specialist workshop.

#### **WARNING**

If you fit unsuitable accessories onto tire valves, the tire valves may be overloaded and malfunction, which can cause tire pressure loss. Due to their design, retrofitted tire pressure monitors keep the tire valve open. This can also result in tire pressure loss. There is a risk of an accident.

Only screw the standard valve cap or other valve caps approved by Mercedes-Benz for your vehicle onto the tire valve.

Use a suitable pressure gage to check the tire pressure. The outer appearance of a tire does not permit any reliable conclusion about the tire pressure. On vehicles equipped with the electronic tire pressure monitor, the tire pressure can be checked in the on-board computer.

The tire temperature and pressure increase when the vehicle is in motion. This is dependent on the driving speed and the load.

Therefore, you should only correct tire pressures when the tires are cold.

The tires are cold:

- if the vehicle has been parked with the tires out of direct sunlight for at least three hours and
- if the vehicle has not been driven further than 1 mile (1.6 km)

The tire temperature changes depending on the outside temperature, the vehicle speed and the tire load. If the tire temperature changes by 18 °F (10 °C), the tire pressure changes by approximately 10 kPa (0.1 bar / 1.5 psi). Take this into account when checking the pressure of warm tires. Only correct the tire pressure if it is too low for the current operating conditions. If you check the tire pressure when the tires are warm, the resulting value will be higher than if the tires were cold. This is normal. Do not reduce the tire

pressure to the value specified for cold tires. The tire pressure would otherwise be too low. Observe the recommended tire pressures for cold tires:

- on the Tire and Loading Information placard on the B-pillar on the driver's side
- in the tire pressure table on the inside of the fuel filler flap
- printed in yellow on the rim of the emergency/collapsible spare wheel (depending on vehicle equipment)

### **Underinflated or overinflated tires**

#### **Underinflated tires**

##### **WARNING**

Tires with pressure that is too low can overheat and burst as a consequence. In addition, they also suffer from excessive and/or irregular wear, which can severely impair the braking properties and the driving characteristics. There is a risk of an accident.

Avoid tire pressures that are too low in all the tires, including the spare wheel.

Underinflated tires may:

- overheat, leading to tire defects
- adversely affect handling
- wear excessively and/or unevenly
- have an adverse effect on fuel consumption

#### **Overinflated tires**

##### **WARNING**

Tires with excessively high pressure can burst because they are damaged more easily by road debris, potholes etc. In addition, they also suffer from irregular wear, which can severely impair the braking properties and the driving characteristics. There is a risk of an accident.

Avoid tire pressures that are too high in all the tires, including the spare wheel.

Overinflated tires may:

- increase the braking distance
- adversely affect handling
- wear excessively and/or unevenly
- have an adverse effect on ride comfort
- be more susceptible to damage

### Maximum tire pressures

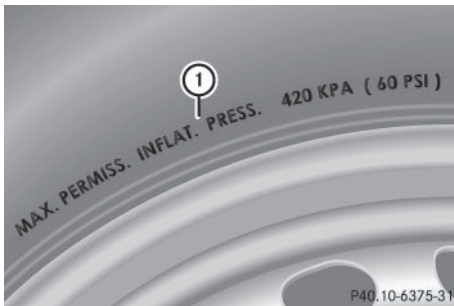

- ① Example: maximum permissible tire pressure

Never exceed the maximum permissible tire inflation pressure. Always observe the recommended tire pressure for your vehicle when adjusting the tire pressure (▷ page 295).

- i** The actual values for tires are vehicle-specific and may deviate from the values in the illustration.

### Checking the tire pressures

#### Important safety notes

Observe the notes on tire pressure (▷ page 295).

Information on air pressure for the tires on your vehicle can be found:

- on the vehicle's Tire and Loading Information placard on the B-pillar
- on the tire pressure label on the fuel filler flap
- in the "Tire pressure" section

### Checking tire pressures manually

To determine and set the correct tire pressure, proceed as follows:

- ▶ Remove the valve cap of the tire that is to be checked.
- ▶ Press the tire pressure gage securely onto the valve.
- ▶ Read the tire pressure and compare it to the recommended value on the Tire and Loading Information placard or the tire pressure table (▷ page 295).
- ▶ If the tire pressure is too low, increase the tire pressure to the recommended value.
- ▶ If the tire pressure is too high, release air. To do so, press down the metal pin in the valve, using the tip of a pen for example. Then check the tire pressure again using the tire pressure checker.
- ▶ Screw the valve cap onto the valve.
- ▶ Repeat these steps for the other tires.

### Tire pressure loss warning system

#### General notes

While the vehicle is in motion, the tire pressure loss warning system monitors the set tire pressure using the rotational speed of the wheels. This enables the system to detect significant pressure loss in a tire. If the speed of rotation of a wheel changes as a result of a loss of pressure, a corresponding warning message will appear in the multifunction display.

You can recognize the tire pressure loss warning by the **Run Flat Indicator Active Press 'OK' to Restart** message which appears in the **Service** menu of the multifunction display. Information on the message display can be found in the "Restarting the tire pressure loss warning system" section (▷ page 299).

### Important safety notes

The tire pressure warning system does not warn you of an incorrectly set tire pressure. Observe the notes on the recommended tire pressure (▷ page 295).

The tire pressure loss warning does not replace the need to regularly check the tire pressure. An even loss of pressure on several tires at the same time cannot be detected by the tire pressure loss warning system.

The tire pressure monitor is not able to warn you of a sudden loss of pressure, e.g. if the tire is penetrated by a foreign object. In the event of a sudden loss of pressure, bring the vehicle to a halt by braking carefully. Avoid abrupt steering maneuvers.

The function of the tire pressure loss warning system is limited or delayed if:

- snow chains are mounted on your vehicle's tires.
- road conditions are wintry.
- you are driving on sand or gravel.
- you adopt a very sporty driving style (cornering at high speeds or driving with high rates of acceleration).
- you are towing a very heavy or large trailer.
- you are driving with a heavy load (in the vehicle or on the roof).

### Restarting the tire pressure loss warning system

Restart the tire pressure loss warning system if you have:

- changed the tire pressure
- changed the wheels or tires
- mounted new wheels or tires
- ▶ Before restarting, make sure that the tire pressures are set properly on all four tires for the respective operating conditions. The recommended tire pressures can be found on the Tire and Loading Information placard on the B-pillar on the driver's side or the tire pressure table on the fuel filler flap.

The tire pressure loss warning system can only give reliable warnings if you have set the correct tire pressure. If an incorrect tire pressure is set, these incorrect values will be monitored.

- ▶ Also observe the notes in the section on tire pressures (▷ page 295).
- ▶ Make sure that the SmartKey is in position 2 in the ignition lock (▷ page 135).
- ▶ Press the ◀ or ▶ button on the steering wheel to select the **Service** menu.
- ▶ Press the ▲ or ▼ button to select **Tire Pressure**.
- ▶ Press the **OK** button.  
The **Run Flat Indicator Active Press 'OK' to Restart** message appears in the multifunction display.

#### If you wish to confirm the restart:

- ▶ Press the **OK** button.  
The **Tire Pressure Now OK?** message appears in the multifunction display.
- ▶ Press the ▲ or ▼ button to select **Yes**.
- ▶ Press the **OK** button.  
The **Run Flat Indicator Restarted** message appears in the multifunction display.  
After a teach-in period, the tire pressure loss warning system will monitor the set tire pressures of all four tires.

#### If you wish to cancel the restart:

- ▶ Press the ↵ button.
- or
- ▶ When the **Tire Pressure Now OK?** message appears, press the ▲ or ▼ button to select **Cancel**.
- ▶ Press the **OK** button.  
The tire pressure values stored at the last restart will continue to be monitored.

## Tire pressure monitor

### General notes

If a tire pressure monitor is installed, the vehicle's wheels have sensors that monitor the tire pressures in all four tires. The tire pressure monitor warns you if the pressure drops in one or more of the tires. The tire pressure monitor only functions if the corresponding sensors are installed in all wheels.

Information on tire pressures is displayed in the multifunction display. After a few minutes of driving, the current tire pressure of each tire is shown in the **Service** menu of the multifunction display; see illustration (example).

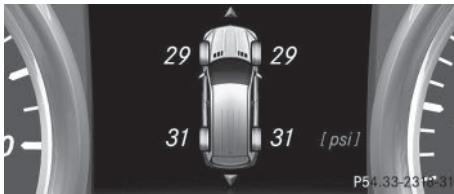

For information on the message display, refer to the "Checking the tire pressure electronically" section (▷ page 301).

### Important safety notes

#### WARNING

Each tire, including the spare (if provided), should be checked at least once a month when cold and inflated to the pressure recommended by the vehicle manufacturer on the Tire and Loading Information placard on the driver's door B-pillar or the tire pressure label on the inside of the fuel filler flap. If your vehicle has tires of a different size than the size indicated on the Tire and Loading Information placard or the tire pressure label, you should determine the proper tire pressure for those tires.

As an added safety feature, your vehicle has been equipped with a tire pressure monitoring system (TPMS) that illuminates a low tire pressure telltale when one or more of your tires are significantly underinflated. Accordingly,

when the low tire pressure telltale illuminates, you should stop and check your tires as soon as possible, and inflate them to the proper pressure. Driving on a significantly underinflated tire causes the tire to overheat and can lead to tire failure. Underinflation also reduces fuel efficiency and tire tread life, and may affect the vehicle's handling and stopping ability.

Please note that the TPMS is not a substitute for proper tire maintenance, and it is the driver's responsibility to maintain correct tire pressure, even if underinflation has not reached the level to trigger illumination of the TPMS low tire pressure telltale.

USA only:

Your vehicle has also been equipped with a TPMS malfunction indicator to indicate if the system is not operating properly. The TPMS malfunction indicator is combined with the low tire pressure telltale. When the system detects a malfunction, the warning lamp will flash for approximately a minute and then remain continuously illuminated. This sequence will be repeated every time the vehicle is started as long as the malfunction exists.

When the malfunction indicator is illuminated, the system may not be able to detect or signal low tire pressure as intended. TPMS malfunctions may occur for a variety of reasons, including the mounting of incompatible replacement or alternate tires or wheels on the vehicle that prevent the TPMS from functioning properly. Always check the TPMS malfunction telltale after replacing one or more tires or wheels on your vehicle to ensure that the replacement or alternate tires and wheels allow the TPMS to continue to function properly.

It is the driver's responsibility to set the tire pressure to that recommended for cold tires which is suitable for the operating situation (▷ page 295). Note that the correct tire pressure for the current operating situation must first be taught-in to the tire pressure monitor.



If there is a substantial loss of pressure, the warning threshold for the warning message is aligned to the reference values taught-in. Restart the tire pressure monitor after adjusting the pressure of the cold tires (▷ page 302). The current pressures are saved as new reference values. As a result, a warning message will appear if the tire pressure drops significantly.

The tire pressure monitor does not warn you of an incorrectly set tire pressure. Observe the notes on the recommended tire pressure (▷ page 295).

The tire pressure monitor is not able to warn you of a sudden loss of pressure, e.g. if the tire is penetrated by a foreign object. In the event of a sudden loss of pressure, bring the vehicle to a halt by braking carefully. Avoid abrupt steering maneuvers.

The tire pressure monitor has a yellow warning lamp in the instrument cluster for indicating pressure loss or a malfunction. Whether the warning lamp flashes or lights up indicates whether a tire pressure is too low or the tire pressure monitor is malfunctioning:

- if the warning lamp is lit continuously, the tire pressure on one or more tires is significantly too low. The tire pressure monitor is not malfunctioning.
- if the warning lamp flashes for around a minute and then remains lit constantly, the tire pressure monitor is malfunctioning.





In addition to the warning lamp, a message appears in the multifunction display. Observe the information on display messages (▷ page 211).

It may take up to ten minutes for a malfunction of the tire pressure monitor to be indicated. A malfunction will be indicated by the tire pressure warning lamp flashing for approximately one minute and then remaining lit. When the malfunction has been rectified, the tire pressure warning lamp goes out after a few minutes of driving.

The tire pressure values indicated by the on-board computer may differ from those meas-

ured at a gas station with a pressure gage. The tire pressures shown by the on-board computer refer to those measured at sea level. At high altitudes, the tire pressure values indicated by a pressure gage are higher than those shown by the on-board computer. In this case, do not reduce the tire pressures. The operation of the tire pressure monitor can be affected by interference from radio transmitting equipment (e.g. radio headphones, two-way radios) that may be being operated in or near the vehicle.

### Checking the tire pressure electronically

- ▶ Make sure that the SmartKey is in position 2 in the ignition lock (▷ page 135).
- ▶ Press the  or  button on the steering wheel to select the **Service** menu.
- ▶ Press the  or  button to select **Tire Pressure**.
- ▶ Press the  button.

The current tire pressure of each tire is shown in the multifunction display.

If the vehicle has been parked for longer than 20 minutes, the **Tire pressure will be displayed after driving a few minutes** message appears.

After a teach-in process, the tire pressure monitor automatically detects new wheels or new sensors. As long as a clear allocation of the tire pressure value to the individual wheels is not possible, the **Tire Pressure Monitor Active** display message is shown instead of the tire pressure display. The tire pressures are already being monitored.

- ❗ If an emergency spare wheel is mounted, the system may continue to show the tire pressure of the wheel that has been removed for a few minutes. If this occurs, note that the value displayed for the position where the spare wheel is mounted is not the same as the current tire pressure of the emergency spare wheel.



### Tire pressure monitor warning messages

If the tire pressure monitor detects a pressure loss in one or more tires, a warning message is shown in the multifunction display and the yellow tire pressure monitor warning lamp comes on.







- If the **Please Correct Tire Pressure** message appears in the multifunction display, the tire pressure in at least one tire is too low and must be corrected at the next opportunity.
  - If the **Check Tires** message appears in the multifunction display, the tire pressure in one or more tires has dropped significantly and the tires must be checked.
  - If the **Warning Tire Malfunction** message appears in the multifunction display, the tire pressure in one or more tires has dropped suddenly and the tires must be checked.
- i** If the wheel positions on the vehicle are rotated, the tire pressures may be displayed for the wrong positions for a short time. This is rectified after a few minutes of driving, and the tire pressures are displayed for the correct positions.

### Restarting the tire pressure monitor

When you restart the tire pressure monitor, all existing warning messages are deleted and the warning lamps go out. The monitor uses the currently set tire pressures as the reference values for monitoring. In most cases, the tire pressure monitor will automatically detect the new reference values after you have changed the tire pressure. However, you can also define reference values manually as described here. The tire pressure monitor then monitors the new tire pressure values.

- ▶ Set the tire pressure to the value recommended for the corresponding driving situation on the Tire and Loading Information placard on the driver's side B-pillar (▷ page 295).

Additional tire pressure values for different loads can also be found on the tire pressure table on the inside of the fuel filler flap (▷ page 295).

- ▶ Make sure that the tire pressure is correct on all four wheels.
- ▶ Make sure that the SmartKey is in position **2** in the ignition lock.
- ▶ Press the  or  button on the steering wheel to select the **Service** menu.
- ▶ Press the  or  button to select **Tire Pressure**.
- ▶ Press the  button.  
The multifunction display shows the current tire pressure for the individual tires or the **Tire pressure will be displayed after driving a few minutes** message.
- ▶ Press the  button.  
The **Use Current Pressures as New Reference Values** message appears in the multifunction display.

#### If you wish to confirm the restart:

- ▶ Press the  button.  
The **Tire Pressure Monitor Restarted** message appears in the multifunction display.  
After driving for a few minutes, the system checks whether the current tire pressures are within the specified range. The new tire pressures are then accepted as reference values and monitored.

#### If you wish to cancel the restart:

- ▶ Press the  button.  
The tire pressure values stored at the last restart will continue to be monitored.

### Radio type approval for the tire pressure monitor

In certain countries, a radio type approval for the tire pressure monitor may be required. The radio type approval number for the tire pressure monitor can be found in the "Wheels

and tires" section of the Digital Operator's Manual.

## Loading the vehicle

### Instruction labels for tires and loads

#### WARNING

Overloaded tires can overheat, causing a blowout. Overloaded tires can also impair the steering and driving characteristics and lead to brake failure. There is a risk of accident.

Observe the load rating of the tires. The load rating must be at least half of the GAWR of your vehicle. Never overload the tires by exceeding the maximum load.

Two instruction labels on your vehicle show the maximum possible load.

- (1) The Tire and Loading Information placard is on the B-pillar on the driver's side. The Tire and Loading Information placard shows the maximum permissible number of occupants and the maximum permissible vehicle load. It also contains details of the tire sizes and corresponding pressures for tires mounted at the factory.
- (2) The vehicle identification plate is on the B-pillar on the driver's side. The vehicle identification plate informs you of the gross vehicle weight rating. It is made up of the vehicle weight, all vehicle occupants, the fuel and the cargo. You can also find information about the maximum gross axle weight rating on the front and rear axle.

The maximum gross axle weight rating is the maximum weight that can be carried by one axle (front or rear axle). Never exceed the maximum load or the maximum gross axle weight rating for the front or rear axle.

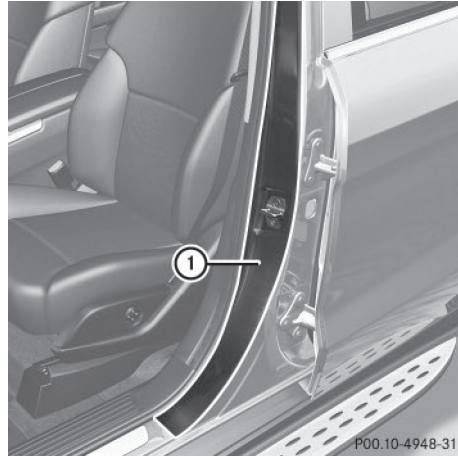

① B-pillar, driver's side

### Maximum permissible gross vehicle weight rating

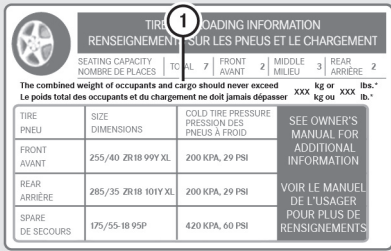

TIRE PNEU	SIZE DIMENSIONS	COLD TIRE PRESSURE PRESSION DES PNEUS A FROID	SEE OWNER'S MANUAL FOR ADDITIONAL INFORMATION
FRONT AVANT	255/40 ZR18 99Y XL	200 KPA, 29 PSI	VOIR LE MANUEL DE L'USAGER POUR PLUS DE RENSEIGNEMENTS
REAR ARRIERE	285/35 ZR18 101Y XL	200 KPA, 29 PSI	
SPARE DE SECOURS	175/55-18 95P	420 KPA, 60 PSI	

P40.00-2224-31

- Specification for maximum gross vehicle weight ① is listed in the Tire and Loading Information placard: "The combined weight of occupants and cargo should never exceed XXX kilograms or XXX lbs."

The gross weight of all vehicle occupants, load and luggage must not exceed the specified value.

- i** The specifications shown on the Tire and Loading Information placard in the illustration are examples. The maximum permissible gross vehicle weight rating is vehicle-specific and may differ from that in the illustration. You can find the valid maximum

permissible gross vehicle weight rating for your vehicle on the Tire and Loading Information placard.

### Number of seats

TIRE AND LOADING INFORMATION RENSEIGNEMENTS SUR LES PNEUS ET LE CHARGEMENT			
SEATING CAPACITY NOMBRE DE PLACES		TOTAL 7	FRONT 2   MIDDLE 3   REAR 2
The combined weight of occupants and cargo should never exceed XXX kg or XXX lbs. Le poids total des occupants et du chargement ne doit jamais dépasser XXX kg ou XXX lbs.			
TIRE PNEU	SIZE DIMENSIONS	COLD TIRE PRESSURE PRESSION DES PNEUS A FROID	SEE OWNER'S MANUAL FOR ADDITIONAL INFORMATION
FRONT AVANT	255/40 ZR18 99Y XL	200 KPA, 29 PSI	VOIR LE MANUEL DE L'USAGER POUR PLUS DE RENSEIGNEMENTS
REAR ARRIÈRE	285/35 ZR18 101Y XL	200 KPA, 29 PSI	
SPARE DE SECOURS	175/55-18 95P	420 KPA, 60 PSI	

P40.00-2225-31

Maximum number of seats ① indicates the maximum number of occupants allowed to travel in the vehicle. This information can be found on the Tire and Loading Information placard.

**i** The specifications shown on the Tire and Loading Information placard in the illustration are examples. The number of seats is vehicle-specific and can differ from the details shown. The number of seats in your vehicle can be found on the Tire and Loading Information placard.

### Determining the correct load limit

#### Step-by-step instructions

The following steps have been developed as required of all manufacturers under Title 49, Code of U.S. Federal Regulations, Part 575 pursuant to the "National Traffic and Motor Vehicle Safety Act of 1966".

► **Step 1:** Locate the statement "The combined weight of occupants and cargo should never exceed XXX kg or XXX lbs." on

your vehicle's Tire and Loading Information placard.

► **Step 2:** Determine the combined weight of the driver and passengers that will be riding in your vehicle.

► **Step 3:** Subtract the combined weight of the driver and passengers from XXX kilograms or XXX lbs.

► **Step 4:** The resulting figure equals the available amount of cargo and luggage load capacity. For example, if the "XXX" amount equals 1400 lbs and there will be five 150-lb passengers in your vehicle, the amount of available cargo and luggage load capacity is 650 lbs (1400 - 750 (5 x 150) = 650 lbs).

► **Step 5:** Determine the combined weight of luggage and cargo being loaded on the vehicle. That weight may not safely exceed the available cargo and luggage load capacity calculated in step 4.

**Example: steps 1 to 3**

The following table shows examples on how to calculate total and cargo load capacities with varying seating configurations and number and size of occupants. The following examples use a load limit of 1500 lbs (680 kg). **This is for illustration purposes only.** Make sure you are using the actual load limit for your vehicle stated on your vehicle's Tire and Loading Information placard (▷ page 303).

The greater the combined weight of the occupants, the lower the maximum luggage load. Additional information when towing a trailer (▷ page 191).

**Step 1**

	Example 1	Example 2	Example 3
<b>Combined maximum weight of occupants and cargo (data from the Tire and Loading Information placard)</b>	1500 lbs (680 kg)	1500 lbs (680 kg)	1500 lbs (680 kg)

**Step 2**

	Example 1	Example 2	Example 3
<b>Number of people in the vehicle (driver and occupants)</b>	5	3	1
<b>Distribution of the occupants</b>	Front: 2 Rear: 3	Front: 1 Rear: 2	Front: 1
<b>Weight of the occupants</b>	Occupant 1: 150 lbs (68 kg) Occupant 2: 180 lbs (82 kg) Occupant 3: 160 lbs (73 kg) Occupant 4: 140 lbs (63 kg) Occupant 5: 120 lbs (54 kg)	Occupant 1: 200 lbs (91 kg) Occupant 2: 190 lbs (86 kg) Occupant 3: 150 lbs (68 kg)	Occupant 1: 150 lbs (68 kg)
<b>Gross weight of all occupants</b>	750 lbs (340 kg)	540 lbs (245 kg)	150 lbs (68 kg)

## Step 3

	Example 1	Example 2	Example 3
<b>Permissible load (maximum gross vehicle weight rating from the Tire and Loading Information placard minus the gross weight of all occupants)</b>	1500 lbs (680 kg) - 750 lbs (340 kg) = 750 lbs (340 kg)	1500 lbs (680 kg) - 540 lbs (245 kg) = =960 lbs (435 kg)	1500 lbs (680 kg) - 150 lbs (68 kg) = 1350 lbs (612 kg)

## Vehicle identification plate

Even if you have calculated the total cargo carefully, you should still make sure that the gross vehicle weight rating and the gross axle weight rating are not exceeded. Details can be found on the vehicle identification plate on the B-pillar on the driver's side of the vehicle (▷ page 303).

**Permissible Gross Vehicle Weight Rating (GVWR):** the gross weight of the vehicle, all passengers, load and trailer load/noseweight (if applicable) must not exceed the permissible gross vehicle weight.

**Gross Axle Weight Rating (GAWR):** the maximum permissible weight that can be carried by one axle (front or rear axle).

To ensure that your vehicle does not exceed the maximum permissible values (gross vehicle weight and maximum gross axle weight rating), have your loaded vehicle (including driver, occupants, cargo, and full trailer load if applicable) weighed on a suitable vehicle weighbridge.

## Trailer load/noseweight

The trailer load/noseweight affects the gross weight of the vehicle. If a trailer is attached, the trailer load/noseweight is included in the load along with occupants and luggage. The trailer load/noseweight is usually approximately 8% of the gross weight of the trailer and its cargo.

## All about wheels and tires

## Uniform Tire Quality Grading Standards

## Overview of Tire Quality Grading Standards

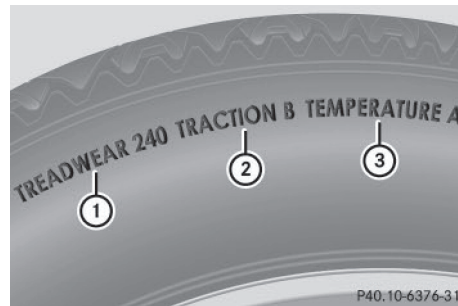

Uniform Tire Quality Grading Standards are U.S. government specifications. Their purpose is to provide drivers with uniform reliable information on tire performance data. Tire manufacturers have to grade tires using three performance factors: ① tread wear grade, ② traction grade and ③ temperature grade. These regulations do not apply to Canada. Nevertheless, all tires sold in North America are provided with the corresponding quality grading markings on the sidewall of the tire. Quality grades can be found, where applicable, on the tire sidewall between tread shoulder and maximum section width.

Example:

- **Treadwear grade:** 200
- **Traction grade:** AA
- **Temperature grade:** A

All passenger car tires must conform to the statutory safety requirements in addition to these grades.

- i** The actual values for tires are vehicle-specific and may deviate from the values in the illustration.

### Treadwear

The treadwear grade is a comparative rating based on the wear rate of the tire when tested under controlled conditions on a specified U.S. government course. For example, a tire graded 150 would wear one and one-half times as well on the government course as a tire graded 100.

The relative performance of tires depends upon the actual conditions of their use, however, and may depart significantly from the norm due to variations in driving habits, service practices and differences in road characteristics and climate.

### Traction

#### WARNING

The traction grade assigned to this tire is based on straight-ahead braking traction tests, and does not include acceleration, cornering, hydroplaning, or peak traction characteristics.

- L** Avoid wheelspin. This can lead to damage to the drive train.

The traction grades – from highest to lowest – are AA, A, B and C. Those grades represent the tire's ability to stop on wet pavement as measured under controlled conditions on specified government test surfaces of asphalt and concrete. A tire marked C may have poor traction performance.

The safe speed on a wet, snow covered or icy road is always lower than on dry road surfaces.

You should pay special attention to road conditions when temperatures are around freezing point.

Mercedes-Benz recommends a minimum tread depth of  $\frac{1}{8}$  in (4 mm) on all four winter tires. Observe the legally required minimum tire tread depth (> page 293). Winter tires can reduce the braking distance on snow-covered surfaces in comparison with summer tires. The braking distance is still much further than on surfaces that are not icy or covered with snow. Take appropriate care when driving. Further information on winter tires (M+S tires) can be found in the Digital Operator's Manual.

### Temperature

#### WARNING

The temperature grade for this tire is established for a tire that is properly inflated and not overloaded. Excessive speed, underinflation, or excessive loading, either separately or in combination, can cause excessive heat build-up and possible tire failure.

The temperature grades are A (the highest), B, and C, representing the tire's resistance to the generation of heat and its ability to dissipate heat when tested under controlled conditions on a specified indoor laboratory test wheel. Sustained high temperature can cause the material of the tire to degenerate and reduce tire life, and excessive temperature can lead to sudden tire failure. The grade C corresponds to a level of performance which all passenger car tires must meet under the Federal Motor Vehicle Safety Standard No. 109. Grades B and A represent higher levels of performance on the laboratory test wheel than the minimum required by law.

## Tire labeling

### Overview

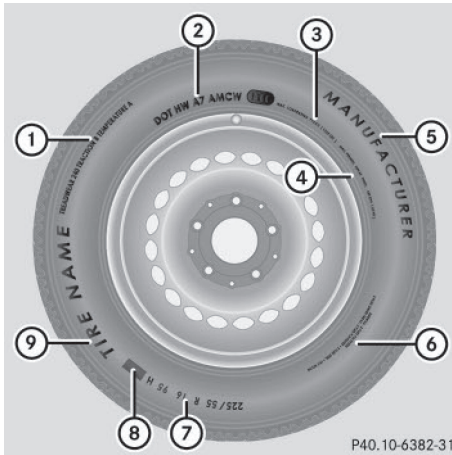

- ① Uniform Tire Quality Grading Standards (▷ page 312)
- ② Department of Transportation, Tire Identification Number (▷ page 311)
- ③ Maximum load rating (▷ page 310)
- ④ Maximum tire pressures (▷ page 298)
- ⑤ Manufacturer
- ⑥ Tire material (▷ page 311)
- ⑦ Tire size designation, load-bearing capacity and speed rating (▷ page 308)
- ⑧ Load index (▷ page 310)
- ⑨ Tire name

The markings described above are on the tire in addition to the tire name (sales designation) and the manufacturer's name.

- ⓘ Tire data is vehicle-specific and may deviate from the data in the example.

### Tire size designation, load-bearing capacity and speed rating

#### ⚠ WARNING

Exceeding the stated tire load-bearing capacity and the approved maximum speed could lead to tire damage or the tire bursting. There is a risk of accident.

Therefore, only use tire types and sizes approved for your vehicle model. Observe the tire load rating and speed rating required for your vehicle.

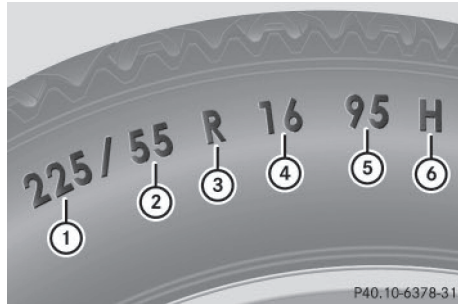

- ① Tire width
- ② Nominal aspect ratio in %
- ③ Tire code
- ④ Rim diameter
- ⑤ Load bearing index
- ⑥ Speed rating

**General:** depending on the manufacturer's standards, the size imprinted in the tire wall may not contain any letters or may contain one letter that precedes the size description. If there is no letter preceding the size description (as shown above): these are passenger vehicle tires according to European manufacturing standards.

If "P" precedes the size description: these are passenger vehicle tires according to U.S. manufacturing standards.

If "LT" precedes the size description: these are light truck tires according to U.S. manufacturing standards.

If "T" precedes the size description: compact emergency wheels with high tire pressure that are only designed for temporary use in an emergency.

**Tire width:** tire width ① shows the nominal tire width in millimeters.

**Height-width ratio:** aspect ratio ② is the size ratio between the tire height and tire width and is shown in percent. The aspect



ratio is calculated by dividing the tire width by the tire height.

**Tire code:** tire code ③ specifies the tire type. "R" represents radial tires; "D" represents diagonal tires; "B" represents diagonal radial tires.

Optionally, tires with a maximum speed of over 149 mph (240 km/h) may have "ZR" in the size description, depending on the manufacturer (e.g. 245/40 ZR 18).

**Rim diameter:** rim diameter ④ is the diameter of the bead seat, not the diameter of the rim flange. The rim diameter is specified in inches (in).

**Load-bearing index:** load-bearing index ⑤ is a numerical code that specifies the maximum load-bearing capacity of a tire.

Do not overload the tires by exceeding the specified load limit. The maximum permissible load can be found on the vehicle's Tire and Loading Information placard on the B-pillar on the driver's side (▷ page 303).

Example:

Load-bearing index 91 indicates a maximum load of 1,356 lb (615 kg) that the tires can bear. For further information on the maximum tire load in kilograms and lbs, see (▷ page 310).

For further information on the load bearing index, see "Load index" (▷ page 310).

**Speed rating:** speed rating ⑥ specifies the approved maximum speed of the tire.

**i** Tire data is vehicle-specific and may deviate from the data in the example.

Regardless of the speed rating, always observe the speed limits. Drive carefully and adapt your driving style to the traffic conditions.

### Summer tires

Index	Speed rating
Q	up to 100 mph (160 km/h)
R	up to 106 mph (170 km/h)

Index	Speed rating
S	up to 112 mph (180 km/h)
T	up to 118 mph (190 km/h)
H	up to 130 mph (210 km/h)
V	up to 149 mph (240 km/h)
W	up to 168 mph (270 km/h)
Y	up to 186 mph (300 km/h)
ZR...Y	up to 186 mph (300 km/h)
ZR...(..Y)	over 186 mph (300 km/h)
ZR	over 149 mph (240 km/h)

- Optionally, tires with a maximum speed of over 149 mph (240 km/h) may have "ZR" in the size description, depending on the manufacturer (e.g. 245/40 ZR 18).

The service specification is made up of load-bearing index ⑤ and speed rating ⑥.

- If the size description of your tire includes "ZR" and there are no service specifications, ask the tire manufacturer in order to find out the maximum speed.

If a service specification is available, the maximum speed is limited according to the speed rating in the service specification.

Example: 245/40 ZR 18 97 Y. In this example, "97 Y" is the service specification. The letter "Y" represents the speed rating. The maximum speed of the tire is limited to 186 mph (300 km/h).

- The size description for all tires with maximum speeds of over 186 mph (300 km/h) must include "ZR", **and** the service specification must be given in parentheses. Example: 275/40 ZR 18 (99 Y). Speed rating "(Y)" indicates that the maximum speed of the tire is over 186 mph (300 km/h). Ask the tire manufacturer about the maximum speed.

### All-weather tires and winter tires

Index	Speed rating
Q M+S <sup>2</sup>	up to 100 mph (160 km/h)
T M+S <sup>2</sup>	up to 118 mph (190 km/h)
H M+S <sup>2</sup>	up to 130 mph (210 km/h)
V M+S <sup>2</sup>	up to 149 mph (240 km/h)

**i** Not all tires with the M+S marking provide the driving characteristics of winter tires. In addition to the M+S marking, winter tires also have the  snowflake symbol on the tire wall. Tires with this marking fulfill the requirements of the Rubber Manufacturers Association (RMA) and the Rubber Association of Canada (RAC) regarding the tire traction on snow. They have been especially developed for driving on snow.

An electronic speed limiter prevents your vehicle from exceeding the following speeds:

- All vehicles (except AMG vehicles): 130 mph (210 km/h)
- AMG vehicles: 155 mph (250 km/h)
- AMG vehicles with increased top speed: 174 mph (280 km/h)

The speed rating of tires mounted at the factory may be higher than the maximum speed that the electronic speed limiter permits.

Make sure that your tires have the required speed rating, e.g. when buying new tires. The required speed rating for your vehicle can be found in the "Tires" section (▷ page 319).

Further information about reading tire data can be obtained from any qualified specialist workshop.

### Load index



In addition to the load bearing index, load index **1** may be imprinted after the letters that identify speed index **6** on the sidewall of the tire (▷ page 308).

- If no specification is given: no text (as in the example above), represents a standard load (SL) tire
- XL or Extra Load: represents a reinforced tire
- Light Load: represents a light load tire
- C, D, E: represents a load range that depends on the maximum load that the tire can carry at a certain pressure

**i** Tire data is vehicle-specific and may deviate from the data in the example.

### Maximum load rating



Maximum tire load **1** is the maximum permissible weight for which the tire is approved. Do not overload the tires by exceeding the specified load limit. The maximum permissi-

<sup>2</sup> Or M+S  for winter tires.

ble load can be found on the vehicle's Tire and Loading Information placard on the B-pillar on the driver's side (▷ page 303).

- i** The actual values for tires are vehicle-specific and may deviate from the values in the illustration.

### DOT, Tire Identification Number (TIN)

US tire regulations stipulate that every tire manufacturer or retreader must imprint a TIN in or on the sidewall of each tire produced.

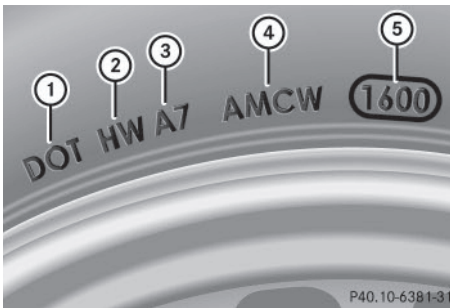

The TIN is a unique identification number. The TIN enables the tire manufacturers or retreaders to inform purchasers of recalls and other safety-relevant matters. It makes it possible for the purchaser to easily identify the affected tires.

The TIN is made up of manufacturer identification code (2), tire size (3), tire type code (4) and manufacturing date (5).

**DOT (Department of Transportation):** tire symbol (1) marks that the tire complies with the requirements of the U.S. Department of Transportation.

**Manufacturer identification code:** manufacturer identification code (2) provides details on the tire manufacturer. New tires have a code with two symbols. Retreaded tires have a code with four symbols.

For further information about retreaded tires, see (▷ page 319).

**Tire size:** identifier (3) describes the tire size.

**Tire type code:** tire type code (4) can be used by the manufacturer as a code to describe specific characteristics of the tire.

**Date of manufacture:** date of manufacture (5) provides information about the age of a tire. The first and second positions represent the week of manufacture, starting with "01" for the first calendar week. Positions three and four represent the year of manufacture. For example, a tire that is marked with "3208", was manufactured in week 32 in 2008.

- i** Tire data is vehicle-specific and may deviate from the data in the example.

### Tire characteristics

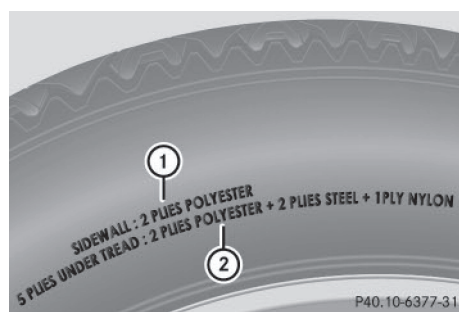

This information describes the type of tire cord and the number of layers in sidewall (1) and under tire tread (2).

- i** Tire data is vehicle-specific and may deviate from the data in the example.

### Definition of terms for tires and loading

#### Tire ply composition and material used

Describes the number of plies or the number of layers of rubber-coated fabric in the tire tread and sidewall. These are made of steel, nylon, polyester and other materials.

#### Bar

Metric unit for tire pressure. 14.5038 pounds per square inch (psi) and 100 kilopascals (kPa) are the equivalent of 1 bar.

**DOT (Department of Transportation)**

DOT-marked tires fulfill the requirements of the U S Department of Transportation.

**Normal occupant weight**

The number of occupants for which the vehicle is designed multiplied by 68 kilograms (150 lbs).

**Uniform Tire Quality Grading Standards**

A uniform standard to grade the quality of tires with regards to tread quality, tire traction and temperature characteristics. The quality grading assessment is made by the manufacturer following specifications from the U.S. government. The ratings are molded into the sidewall of the tire.

**Recommended tire pressures**

The recommended tire pressure applies to the tires mounted at the factory.

The Tire and Loading Information placard contains the recommended tire pressures for cold tires on a fully loaded vehicle and for the maximum permissible vehicle speed.

The tire pressure table contains the recommended pressures for cold tires for various operating conditions, i.e. differing load and speed conditions.

**Increased vehicle weight due to optional equipment**

The combined weight of all standard and optional equipment available for the vehicle, regardless of whether it is actually installed on the vehicle or not.

**Rim**

This is the part of the wheel on which the tire is mounted.

**GAWR (Gross Axle Weight Rating)**

The GAWR is the maximum gross axle weight rating. The actual load on an axle must never exceed the gross axle weight rating. The gross axle weight rating can be found on the vehicle identification plate on the B-pillar on the driver's side.

**Speed rating**

The speed rating is part of the tire identification. It specifies the speed range for which the tire is approved.

**GTW (Gross Trailer Weight)**

The GTW is the weight of a trailer including the weight of the load, luggage, accessories etc. on the trailer.

**GVW (Gross Vehicle Weight)**

The gross vehicle weight includes the weight of the vehicle including fuel, tools, the spare wheel, accessories installed, occupants, luggage and the drawbar noseweight, if applicable. The gross vehicle weight must not exceed the gross vehicle weight rating GVWR as specified on the vehicle identification plate on the B-pillar on the driver's side.

**GVWR (Gross Vehicle Weight Rating)**

The GVWR is the maximum permissible gross weight of a fully loaded vehicle (the weight of the vehicle including all accessories, occupants, fuel, luggage and the drawbar noseweight, if applicable). The gross vehicle weight rating is specified on the vehicle identification plate on the B-pillar on the driver's side.

**Maximum loaded vehicle weight**

The maximum weight is the sum of:

- the curb weight of the vehicle
- the weight of the accessories
- the load limit
- the weight of the factory installed optional equipment

**Kilopascal (kPa)**

Metric unit for tire pressure. 6.9 kPa corresponds to 1 psi. Another unit for tire pressure is bar. 100 kilopascals (kPa) are the equivalent of 1 bar.

**Load index**

In addition to the load-bearing index, the load index may also be imprinted on the sidewall of

the tire. This specifies the load-bearing capacity more precisely.

**Curb weight**

The weight of a vehicle with standard equipment including the maximum capacity of fuel, oil and coolant. It also includes the air-conditioning system and optional equipment if these are installed in the vehicle, but does not include passengers or luggage.

**Maximum load rating**

The maximum load rating is the maximum permissible weight in kilograms or lbs for which a tire is approved.

**Maximum permissible tire pressure**

Maximum permissible tire pressure for one tire.

**Maximum load on one tire**

Maximum load on one tire. This is calculated by dividing the maximum axle load of one axle by two.

**PSI (pounds per square inch)**

A standard unit of measure for tire pressure.

**Aspect ratio**

Relationship between tire height and tire width in percent.

**Tire pressure**

This is pressure inside the tire applying an outward force to each square inch of the tire's surface. The tire pressure is specified in pounds per square inch (psi), in kilopascal (kPa) or in bar. The tire pressure should only be corrected when the tires are cold.

**Cold tire pressure**

The tires are cold:

- if the vehicle has been parked without direct sunlight on the tires for at least three hours and
- if the vehicle has not been driven further than 1 mile (1.6 km)

**Tread**

The part of the tire that comes into contact with the road.

**Bead**

The tire bead ensures that the tire sits securely on the wheel. There are several steel wires in the bead to prevent the tire from coming loose from the wheel rim.

**Sidewall**

The part of the tire between the tread and the bead.

**Weight of optional extras**

The combined weight of those optional extras that weigh more than the replaced standard parts and more than 2.3 kg (5 lbs). These optional extras, such as high-performance brakes, level control, a roof rack or a high-performance battery, are not included in the curb weight and the weight of the accessories.

**TIN (Tire Identification Number)**

This is a unique identifier which can be used by a tire manufacturer to identify tires, for example for a product recall, and thus identify the purchasers. The TIN is made up of the manufacturer's identity code, tire size, tire type code and the manufacturing date.

**Load bearing index**

The load bearing index (also load index) is a code that contains the maximum load bearing capacity of a tire.

**Traction**

Traction is the result of friction between the tires and the road surface.

**TWR (Tongue Weight Rating)**

The TWR specifies the maximum permissible weight that the ball coupling of the trailer tow hitch can support.

**Treadwear indicators**

Narrow bars (tread wear bars) that are distributed over the tire tread. If the tire tread is level with the bars, the wear limit of  $\frac{1}{16}$  in (1.6 mm) has been reached.

**Occupant distribution**

The distribution of occupants in a vehicle at their designated seating positions.

**Total load limit**

Nominal load and luggage load plus 68 kg (150 lbs) multiplied by the number of seats in the vehicle.

**Changing a wheel****Flat tire**

The "Breakdown assistance" section (▷ page 275) contains information and notes on how to deal with a flat tire. Information on driving with MOExtended tires in the event of a flat tire can be found under "MOExtended tires (tires with run-flat characteristics)" (▷ page 275).

**Vehicles with an emergency spare wheel:** in the event of a flat tire, mount the emergency spare wheel according to the description under "Mounting a wheel" (▷ page 315).

**Rotating the wheels** **WARNING**

Interchanging the front and rear wheels may severely impair the driving characteristics if the wheels or tires have different dimensions. The wheel brakes or suspension components may also be damaged. There is a risk of accident.

Rotate front and rear wheels only if the wheels and tires are of the same dimensions.

**!** On vehicles equipped with a tire pressure monitor, electronic components are located in the wheel.

Tire-mounting tools should not be used near the valve. This could damage the electronic components.

Only have tires changed at a qualified specialist workshop.

Always observe the instructions and safety notes in the "Mounting a wheel" section (▷ page 315).

The wear patterns on the front and rear tires differ, depending on the operating conditions. Rotate the wheels before a clear wear pattern has formed on the tires. Front tires typically wear more on the shoulders and the rear tires in the center.

On vehicles that have the same size front and rear wheels, you can rotate the wheels according to the intervals in the tire manufacturer's warranty book in your vehicle documents. If no warranty book is available, the tires should be rotated every 3,000 to 6,000 miles (5,000 to 10,000 km). Depending on tire wear, this may be required earlier. Do not change the direction of wheel rotation.

Clean the contact surfaces of the wheel and the brake disc thoroughly every time a wheel is rotated. Check the tire pressure and, if necessary, restart the tire pressure loss warning system or the tire pressure monitor.

**Direction of rotation**

Tires with a specified direction of rotation have additional benefits, e.g. if there is a risk of hydroplaning. These advantages can only be gained if the tires are installed corresponding to the direction of rotation.

An arrow on the sidewall of the tire indicates its correct direction of rotation.

**Storing wheels**

Store wheels that are not being used in a cool, dry and preferably dark place. Protect the tires from oil, grease, gasoline and diesel.

## Mounting a wheel

### Preparing the vehicle

- ▶ **Vehicle with emergency spare wheel:** when mounting the emergency spare wheel in the event of a flat tire, follow the additional notes on vehicle preparation under "Flat tire" (▷ page 275).
- ▶ Stop the vehicle on solid, non-slippery and level ground.
- ▶ Unload heavy luggage.
- ▶ Apply the electric parking brake manually.
- ▶ Bring the front wheels into the straight-ahead position.
- ▶ Shift the transmission to position **P**.
- ▶ **Vehicles with the AIRMATIC package:** make sure that highway level is selected (▷ page 165).
- ▶ **Vehicles with the ON&OFFROAD package:** make sure that highway level is selected (▷ page 162).
- ▶ Switch off the engine.
- ▶ **Vehicles without KEYLESS-GO:** remove the SmartKey from the ignition lock.
- ▶ **Vehicles with KEYLESS-GO:** open the driver's door. The on-board electronics now have status **0**. This is the same as the SmartKey having been removed.
- ▶ **Vehicles with KEYLESS-GO:** remove the Start/Stop button from the ignition lock (▷ page 135).
- ▶ If included in the vehicle equipment, remove the tire-change tool kit from the vehicle.
- ▶ Safeguard the vehicle against rolling away.

**i** Apart from certain country-specific variations, vehicles are not equipped with a tire-change tool kit. For information on which tools are required to perform a wheel change on your vehicle, consult an authorized Mercedes-Benz Center.

Necessary tire-changing tools can include, for example:

- Jack
- Wheel chock
- Lug wrench

### Securing the vehicle to prevent it from rolling away

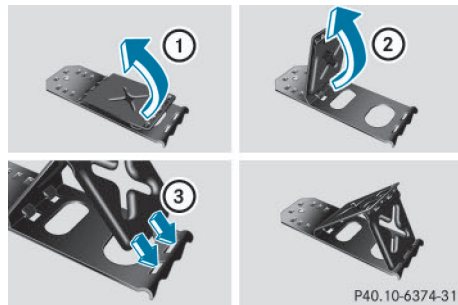

If your vehicle is equipped with a wheel chock, it can be found in the tire-change tool kit (▷ page 274).

The folding wheel chock is an additional safety measure to prevent the vehicle from rolling away, for example when changing a wheel.

- ▶ Fold both plates upwards ①.
- ▶ Fold out lower plate ②.
- ▶ Guide the lugs on the lower plate fully into the openings in base plate ③.



- ▶ **On level ground:** place chocks or other suitable items under the front and rear of the wheel that is diagonally opposite the wheel you wish to change.





- ▶ **On light downhill gradients:** place chocks or other suitable items in front of the wheels of the front and rear axle.

### Raising the vehicle

#### **WARNING**

If you do not position the jack correctly at the appropriate jacking point of the vehicle, the jack could tip over with the vehicle raised. There is a risk of injury.

Only position the jack at the appropriate jacking point of the vehicle. The base of the jack must be positioned vertically, directly under the jacking point of the vehicle.

- ❗ **AMG vehicles with "Minispare" emergency spare wheel:** use the "Minispare" emergency spare wheel **only on the rear axle**. If you mount the "Minispare" emergency spare wheel on the front axle, this could result in damage to the brake system.

If a tire on the front axle is defective, an intact wheel from the rear axle must first be replaced with the "Minispare" emergency spare wheel. The faulty wheel on the front axle may only then be replaced by the undamaged wheel from the rear axle.

Make sure to note the placard on the "Minispare" emergency spare wheel.

- ❗ The jack is designed exclusively for jacking up the vehicle at the jacking points. Otherwise, your vehicle could be damaged.

Observe the following when raising the vehicle:

- To raise the vehicle, only use the vehicle-specific jack that has been tested and approved by Mercedes-Benz. If used incorrectly, the jack could tip over with the vehicle raised.
- The jack is designed only to raise and hold the vehicle for a short time while a wheel is being changed. It is not suited for performing maintenance work under the vehicle.
- Avoid changing the wheel on uphill and downhill slopes.
- Before raising the vehicle, secure it from rolling away by applying the parking brake and inserting wheel chocks. Do not disengage the parking brake while the vehicle is raised.
- The jack must be placed on a firm, flat and non-slip surface. On a loose surface, a large, flat, load-bearing underlay must be used. On a slippery surface, a non-slip underlay must be used, e.g. rubber mats.
- Do not use wooden blocks or similar objects as a jack underlay. Otherwise, the jack will not be able to achieve its load-bearing capacity due to the restricted height.
- Make sure that the distance between the underside of the tires and the ground does not exceed 1.2 in (3 cm).
- Do not place your hands or feet under the raised vehicle.
- Do not lie under the vehicle.
- Do not start the engine when the vehicle is raised.
- Never open or close a door or the tailgate when the vehicle is raised.
- Make sure that no persons are present in the vehicle when the vehicle is raised.

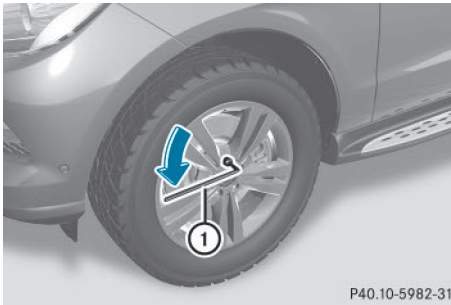

P40.10-5982-31

- ▶ Using lug wrench (1), loosen the bolts on the wheel you wish to change by about one full turn. Do not unscrew the bolts completely.

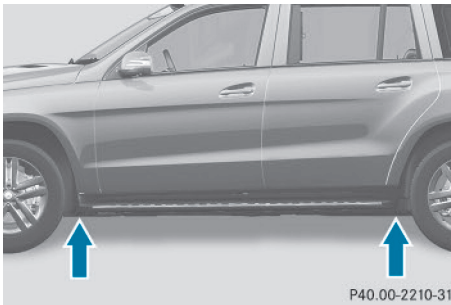

P40.00-2210-31

The jacking points are located just behind the front wheel housings and just in front of the rear wheel housings (arrows).

- ▶ Take the ratchet wrench out of the vehicle tool kit and place it on the hexagon nut of the jack so that the letters **AUF** are visible.

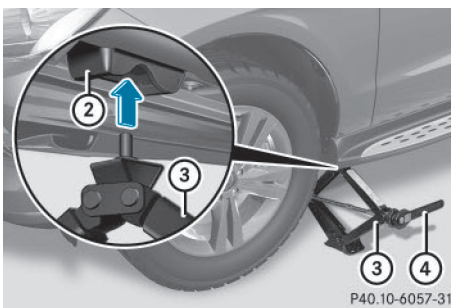

P40.10-6057-31

- ▶ Position jack (3) at jacking point (2).

The alignment bolt on the jack must be inserted into the intended opening on the jacking point.

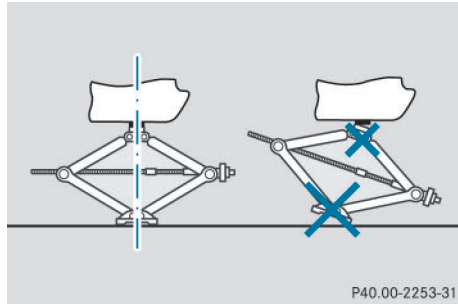

P40.00-2253-31

- ▶ Make sure the foot of the jack is directly beneath the jacking point.
- ▶ Turn ratchet wrench (4) until jack (3) sits completely on jacking point (2) and the base of the jack lies evenly on the ground.
- ▶ Turn ratchet wrench (4) until the tire is raised a maximum of 1.2 in (3 cm) from the ground.

### Removing a wheel

- ❗ Do not place wheel bolts in sand or on a dirty surface. The bolt and wheel hub threads could otherwise be damaged when you screw them in.

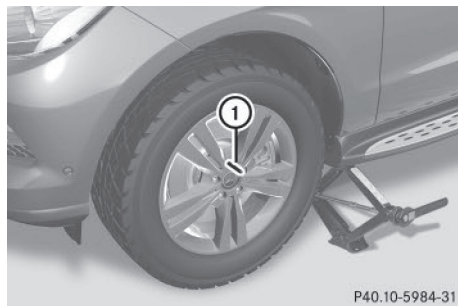

P40.10-5984-31

- ▶ Unscrew the uppermost wheel bolt completely.
- ▶ Screw alignment bolt (1) into the thread instead of the wheel bolt.
- ▶ Unscrew the remaining wheel bolts fully.
- ▶ Remove the wheel.

### Mounting a new wheel

#### WARNING

Oiled or greased wheel bolts or damaged wheel bolts/hub threads can cause the wheel bolts to come loose. As a result, you could lose a wheel while driving. There is a risk of accident.

Never oil or grease wheel bolts. In the event of damage to the threads, contact a qualified specialist workshop immediately. Have the damaged wheel bolts or hub threads replaced/renewed. Do not continue driving.

#### WARNING

If you tighten the wheel bolts or wheel nuts when the vehicle is raised, the jack could tip over. There is a risk of injury.

Only tighten the wheel bolts or wheel nuts when the vehicle is on the ground.

**!** To prevent damage to the paintwork, hold the wheel securely against the wheel hub while screwing in the first wheel bolt.

Always pay attention to the instructions and safety notes in the "Changing a wheel" section (> page 314).

Only use wheel bolts that have been designed for the wheel and the vehicle. For safety reasons, Mercedes-Benz recommends that you only use wheel bolts which have been approved for Mercedes-Benz vehicles and the respective wheel.

**!** Always use wheel bolts ② to mount the "Minispare" emergency spare wheel. Using other wheel bolts to mount the "Minispare" emergency spare wheel could damage the brake system.

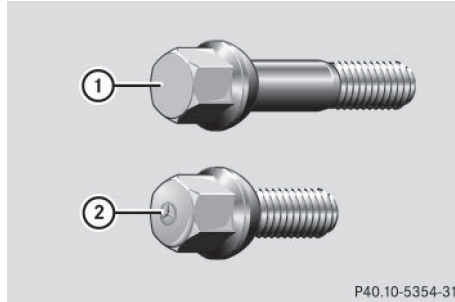

P40.10-5354-31

- ① Wheel bolts for all wheels supplied by the factory
- ② Wheel bolts for the collapsible spare wheel

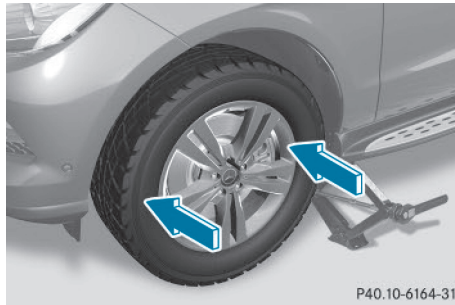

P40.10-6164-31

- ▶ Clean the wheel and wheel hub contact surfaces.
- ▶ Slide the wheel to be mounted onto the alignment bolt and push it on.
- ▶ Tighten the wheel bolts until they are finger-tight.
- ▶ Unscrew the alignment bolt.
- ▶ Tighten the last wheel bolt until it is finger-tight.

### Lowering the vehicle

#### WARNING

The wheels could work loose if the wheel nuts and bolts are not tightened to the specified tightening torque. There is a risk of accident.

Have the tightening torque immediately checked at a qualified specialist workshop after a wheel is changed.

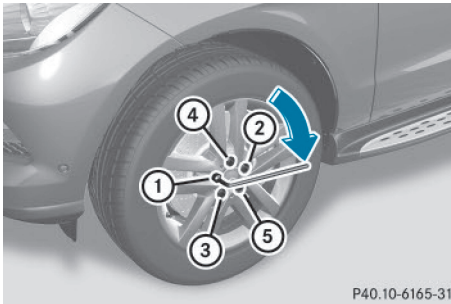

- ▶ Place the ratchet wrench onto the hexagon nut of the jack so that the letters **AB** are visible.
  - ▶ Turn the ratchet wrench until the vehicle is once again standing firmly on the ground.
  - ▶ Place the jack to one side.
  - ▶ Tighten the wheel bolts evenly in a cross-wise pattern in the sequence indicated (① to ⑤). The tightening torque must be **110 lb-ft (150 Nm)**.
  - ▶ Turn the jack back to its initial position.
  - ▶ Stow the jack and the rest of the tire-change tool kit in the stowage well under the cargo compartment floor again.
  - ▶ Check the tire pressure of the newly mounted wheel and adjust it if necessary. Observe the recommended tire pressure (> page 295).
- i** Vehicles with tire pressure monitor: all wheels mounted must be equipped with functioning sensors.

## Wheel and tire combinations

### General notes

- !** For safety reasons, Mercedes-Benz recommends that you only use tires and wheels which have been approved by Mercedes-Benz specifically for your vehicle.

These tires have been specially adapted for use with the control systems, such as ABS or ESP<sup>®</sup>, and are marked as follows:

- MO = Mercedes-Benz Original
- MOE = Mercedes-Benz Original Extended (tires featuring run-flat characteristics)
- MO1 = Mercedes-Benz Original (only certain AMG tires)

Mercedes-Benz Original Extended tires may only be used on wheels that have been specifically approved by Mercedes-Benz.

Only use tires, wheels or accessories tested and approved by Mercedes-Benz. Certain characteristics, e.g. handling, vehicle noise emissions or fuel consumption, may otherwise be adversely affected. In addition, when driving with a load, tire dimension variations could cause the tires to come into contact with the bodywork and axle components. This could result in damage to the tires or the vehicle.

Mercedes-Benz accepts no liability for damage resulting from the use of tires, wheels or accessories other than those tested and approved.

Information on tires, wheels and approved combinations can be obtained from any qualified specialist workshop.

- !** Retreaded tires are neither tested nor recommended by Mercedes-Benz, since previous damage cannot always be detected on retreaded tires. As a result, Mercedes-Benz cannot guarantee vehicle safety if retreaded tires are mounted. Do not mount used tires if you have no information about their previous usage.

Overview of abbreviations used in the following tire tables:

- BA: both axles
- FA: front axle
- RA: rear axle

The recommended pressures for various operating conditions can be found:

- on the Tire and Loading Information placard with the recommended tire pressures on the B-pillar on the driver's side
- in the tire pressure table on the inside of the fuel filler flap

Observe the notes on recommended tire pressures under various operating conditions (▷ page 295).

Check tire pressures regularly, and only when the tires are cold. Comply with the maintenance recommendations of the tire manufacturer in the vehicle document wallet.

Notes on the vehicle equipment – always equip the vehicle with:

- tires of the same size across an axle (left and right)
- the same type of tires at a given time (summer tires, winter tires, MOExtended tires)

Vehicles equipped with MOExtended tires are not equipped with a TIREFIT kit at the factory. It is therefore recommended that you additionally equip your vehicle with a TIREFIT kit if you mount tires that do not feature run-flat properties, e.g. winter tires. A TIREFIT kit may be obtained from a qualified specialist workshop.

## Wheels and tires

**i** Not all wheel and tire combinations are available at the factory for all countries.

**i** The following pages contain information on approved wheel rims and tire sizes for equipping your vehicle with winter tires. Winter tires are not available at the factory as standard equipment or optional extras. If you want to equip your vehicle with approved winter tires, it may be necessary to obtain wheel rims in the corresponding size. The size of the approved winter tires may differ from the standard tires. This is dependent on the model and the equipment installed at the factory.

The tires and wheel rims, as well as further information, can be obtained at a qualified specialist workshop.

**Tires****GL 350 BlueTEC 4MATIC****All-weather tires****R 19**

Tires	Alloy wheels
BA: 275/55 R 19 111 H M+S <sup>3</sup>	BA: 8.5 J x 19 H2 Wheel offset: 2.44 in (62 mm)

**R 20**

Tires	Alloy wheels
BA: 275/50 R 20 109 H M+S <sup>3, 4</sup>	BA: 8.5 J x 20 H2 Wheel offset: 2.44 in (62 mm)

**All-terrain tires****R 18**

Tires	Alloy wheels
BA: 265/60 R 18 110 H M+S	BA: 8.0 J x 18 H2 Wheel offset: 2.22 in (56.5 mm)

**R 19**

Tires	Alloy wheels
BA: 275/55 R 19 111 H M+S <sup>3</sup>	BA: 8.5 J x 19 H2 Wheel offset: 2.44 in (62 mm)

**Winter tires****R 18**

Tires	Alloy wheels
BA: 265/60 R 18 110 H M+S 	BA: 8.0 J x 18 H2 Wheel offset: 2.22 in (56.5 mm)

<sup>3</sup> Use of snow chains not permitted. Observe the notes in the "Snow chains" section.

<sup>4</sup> Available as MOExtended tires.

**R 19**

Tires	Alloy wheels
BA: 265/55 R 19 109 H M+S 	BA: 8.5 J x 19 H2 Wheel offset: 2.44 in (62 mm)

**R 20**

Tires	Alloy wheels
BA: 275/50 R 20 109 H M+S 	BA: 8.5 J x 20 H2 Wheel offset: 2.44 in (62 mm)

**GL 450****All-weather tires****R 19**

Tires	Alloy wheels
BA: 275/55 R 19 111 H M+S <sup>3</sup>	BA: 8.5 J x 19 H2 Wheel offset: 2.44 in (62 mm)

**R 20**

Tires	Alloy wheels
BA: 275/50 R 20 109 H M+S <sup>3, 4</sup>	BA: 8.5 J x 20 H2 Wheel offset: 2.44 in (62 mm)

**All-terrain tires****R 19**

Tires	Alloy wheels
BA: 275/55 R 19 111 H M+S <sup>3</sup>	BA: 8.5 J x 19 H2 Wheel offset: 2.44 in (62 mm)

**Winter tires****R 19**

Tires	Alloy wheels
BA: 265/55 R 19 109 H M+S 	BA: 8.5 J x 19 H2 Wheel offset: 2.44 in (62 mm)

<sup>3</sup> Use of snow chains not permitted. Observe the notes in the "Snow chains" section.

<sup>4</sup> Available as MOExtended tires.



**R 20**

Tires	Alloy wheels
BA: 275/50 R 20 109 H M+S 	BA: 8.5 J x 20 H2 Wheel offset: 2.44 in (62 mm)

**GL 450 4MATIC****All-weather tires****R 19**

Tires	Alloy wheels
BA: 275/55 R 19 111 H M+S <sup>3</sup>	BA: 8.5 J x 19 H2 Wheel offset: 2.44 in (62 mm)

**R 20**

Tires	Alloy wheels
BA: 275/50 R 20 109 H M+S <sup>3, 4</sup>	BA: 8.5 J x 20 H2 Wheel offset: 2.44 in (62 mm)

**All-terrain tires****R 19**

Tires	Alloy wheels
BA: 275/55 R 19 111 H M+S <sup>3</sup>	BA: 8.5 J x 19 H2 Wheel offset: 2.44 in (62 mm)

**Winter tires****R 19**

Tires	Alloy wheels
BA: 265/55 R 19 109 H M+S 	BA: 8.5 J x 19 H2 Wheel offset: 2.44 in (62 mm)

**R 20**

Tires	Alloy wheels
BA: 275/50 R 20 109 H M+S 	BA: 8.5 J x 20 H2 Wheel offset: 2.44 in (62 mm)

<sup>3</sup> Use of snow chains not permitted. Observe the notes in the "Snow chains" section.

<sup>4</sup> Available as MOExtended tires.

**GL 550 4MATIC****All-weather tires****R 20**

Tires	Alloy wheels
BA: 275/50 R 20 109 H M+S <sup>3, 4</sup>	BA: 8.5 J x 20 H2 Wheel offset: 2.44 in (62 mm)

**R 21**

Tires	Alloy wheels
BA: 295/40 R 21 111 V XL M+S <sup>3, 5</sup>	BA: 10.0 J x 21 H2 Wheel offset: 1.81 in (46 mm)
BA: 295/40 R 21 111 W XL M+S <sup>3, 5</sup>	BA: 10.0 J x 21 H2 Wheel offset: 1.81 in (46 mm)

**All-terrain tires****R 19**

Tires	Alloy wheels
BA: 275/55 R 19 111 H M+S <sup>3</sup>	BA: 8.5 J x 19 H2 Wheel offset: 2.44 in (62 mm)

**Winter tires****R 19**

Tires	Alloy wheels
BA: 265/55 R 19 109 H M+S 	BA: 8.5 J x 19 H2 Wheel offset: 2.44 in (62 mm)

**R 20**

Tires	Alloy wheels
BA: 275/50 R 20 109 H M+S 	BA: 8.5 J x 20 H2 Wheel offset: 2.44 in (62 mm)
BA: 275/45 R 20 110 V XL M+S  <sup>5</sup>	BA: 9.0 J x 20 H2 Wheel offset: 1.61 in (41 mm)

<sup>3</sup> Use of snow chains not permitted. Observe the notes in the "Snow chains" section.

<sup>4</sup> Available as MOExtended tires.

<sup>5</sup> Only available on vehicles with the AMG Sports-package (code P 31).

## GL 63 AMG 4MATIC

## Summer tires

## R 21

Tires	Alloy wheels
BA: 295/40 ZR 21 111 Y XL <sup>3</sup>	BA: 10.0 J x 21 H2 Wheel offset: 1.81 in (46 mm)

## Winter tires

## R 20

Tires	Alloy wheels
BA: 275/45 R 20 110 V XL M+S 	BA: 9.0 J x 20 H2 Wheel offset: 1.61 in (41 mm)

## Emergency spare wheel

## Important safety notes

 **WARNING**

The wheel or tire size as well as the tire type of the spare wheel or emergency spare wheel and the wheel to be replaced may differ.

Mounting an emergency spare wheel may severely impair the driving characteristics. There is a risk of an accident.

To avoid hazardous situations:

- adapt your driving style accordingly and drive carefully.
- never mount more than one spare wheel or emergency spare wheel that differs in size.
- only use a spare wheel or emergency spare wheel of a different size briefly.
- do not switch ESP<sup>®</sup> off.
- have a spare wheel or emergency spare wheel of a different size replaced at the nearest qualified specialist workshop. Observe that the wheel and tire dimensions as well as the tire type must be correct.

**!** **AMG vehicles with "Minispare" emergency spare wheel:** use the "Minispare"

emergency spare wheel **only on the rear axle**. If you mount the "Minispare" emergency spare wheel on the front axle, this could result in damage to the brake system.

If a tire on the front axle is defective, an intact wheel from the rear axle must first be replaced with the "Minispare" emergency spare wheel. The faulty wheel on the front axle may only then be replaced by the undamaged wheel from the rear axle.

Make sure to note the placard on the "Minispare" emergency spare wheel.

When using an emergency spare wheel or spare wheel of a different size, you must not exceed the maximum speed of 50 mph (80 km/h).

Snow chains must not be mounted on emergency spare wheels.

## General notes

Mounting the emergency spare wheel is described under "Mounting a wheel" (> page 315).

You should regularly check the pressure of the emergency spare wheel, particularly prior to long trips, and correct the pressure as nec-

<sup>3</sup> Use of snow chains not permitted. Observe the notes in the "Snow chains" section.

essary (▷ page 295). The value on the wheel or as given in the "Wheels and tires" section is valid (▷ page 328).

An emergency spare wheel may also be mounted against the direction of rotation. Observe the time restriction on use as well as the speed limitation specified on the emergency spare wheel.

Replace the tires after six years at the latest, regardless of wear. This also applies to the emergency spare wheel.

- i** When you are driving with the collapsible spare wheel mounted, the tire pressure loss warning system or the tire pressure monitor cannot function reliably. Only restart the tire pressure loss warning system or tire pressure monitor when the defective wheel has been replaced with a new wheel.

#### Vehicles with tire pressure monitor:

after mounting an emergency spare wheel, the system may still display the tire pressure of the removed wheel for a few minutes. The value displayed for the mounted emergency spare wheel is not the same as the current tire pressure of the emergency spare wheel.

### Removing the emergency spare wheel

#### Vehicles with a "Minispare" emergency spare wheel under the cargo compartment floor

Always observe the instructions and safety notes in the "Mounting a wheel" section (▷ page 315).

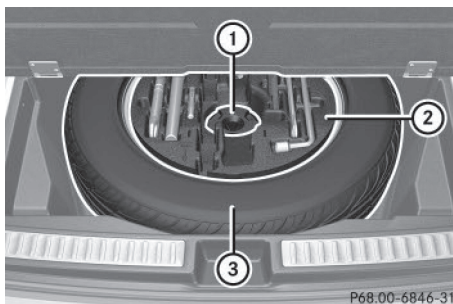

Emergency spare wheel (example: vehicle without lockable cargo compartment floor)

- ▶ **To remove the emergency spare wheel:** lift the cargo compartment floor up (▷ page 254).
- ▶ **Vehicles with a lockable cargo compartment floor:** remove the stowage tray.
- ▶ Release the Velcro fastener (▷ page 274).
- ▶ Take out the jack.
- ▶ Turn emergency spare wheel retainer ① counter-clockwise and remove it.
- ▶ Remove stowage well ②.
- ▶ Remove "Minispare" emergency spare wheel ③.

#### Vehicles with a "Minispare" emergency spare wheel in the emergency spare wheel bag

On vehicles with a Bang & Olufsen sound system, the "Minispare" emergency spare wheel is packed in an emergency spare wheel bag. The emergency spare wheel bag is secured to the cargo tie-down rings in the cargo compartment.

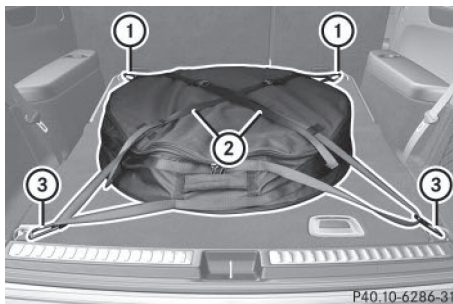

- ▶ **To remove the emergency spare wheel:**
  - detach fastening straps ②.
- ▶ Unhook retaining spring hooks ① and ③ of fastening straps ② from the cargo tie-down rings.
- ▶ Remove the emergency spare wheel bag with the "Minispare" emergency spare wheel.
- ▶ Open the emergency spare wheel bag and remove the "Minispare" emergency spare wheel.
- ▶ **To stow the emergency spare wheel:**
  - place the "Minispare" emergency spare wheel into the emergency spare wheel bag and close the emergency spare wheel bag.
- ▶ Place the emergency spare wheel bag with the "Minispare" emergency spare wheel into the cargo compartment with the carrying strap at the back.
- ▶ Hook retaining spring hooks ① and ③ of fastening straps ② into the cargo tie-down rings.
- ▶ Tighten fastening straps ②.

**Technical data****"Minispare" emergency spare wheel**

<b>Tires</b>	<b>Alloy wheels</b>
T 165/90 R19 119 M	4.5 B x 19 H2
Tire pressure: 420 kPa (4.2 bar/61 psi)	Wheel offset: 1.58 in (40 mm)

Useful information .....	330
Information regarding technical data .....	330
Vehicle electronics .....	330
Identification plates .....	332
Service products and filling capacities .....	333
Vehicle data .....	340
Vehicle data for off-road driving .....	341
Trailer tow hitch .....	343



### Useful information

- i** This Operator's Manual describes all models and all standard and optional equipment of your vehicle available at the time of publication of the Operator's Manual. Country-specific differences are possible. Please note that your vehicle may not be equipped with all features described. This also applies to safety-related systems and functions.
- i** Read the information on qualified specialist workshops (▷ page 35).

### Information regarding technical data

- i** The data stated here specifically refers to a vehicle with standard equipment. Consult an authorized Mercedes-Benz Center for the data for all vehicle variants and trim levels.

### Vehicle electronics

#### Retrofitting two-way radios and mobile phones (RF transmitters)

##### WARNING

The electromagnetic radiation from modified or incorrectly retrofitted RF-transmitters can interfere with the vehicle electronics. This can compromise the operational safety of the vehicle. There is a risk of an accident.

You should have all work to electrical and electronic equipment carried out at a qualified specialist workshop.

##### WARNING

The electromagnetic radiation from incorrectly operated RF transmitters can interfere with the vehicle electronics, for example:

- if the RF transmitter is not connected with an exterior antenna
- the exterior antenna has been installed incorrectly or is not a low-reflection type

This can compromise the operational safety of the vehicle. There is a risk of an accident.

Have the low-reflection exterior antenna mounted at a qualified specialist workshop. When operating RF transmitters in the vehicle, always connect them with the low-reflection exterior antenna.

- !** The operating permit may be invalidated if the instructions for installation and use of RF transmitters are not observed.

In particular, the following conditions must be complied with:

- only approved wavebands may be used.
- compliance with the maximum permissible output in these wavebands is required.
- only approved antenna positions may be used.

Excessive levels of electromagnetic radiation may cause damage to your health and the health of others. Using an exterior antenna takes into account current scientific discussions relating to the possible health hazards that may result from electromagnetic fields.

The following antenna positions may be used if RF transmitters have been properly installed:

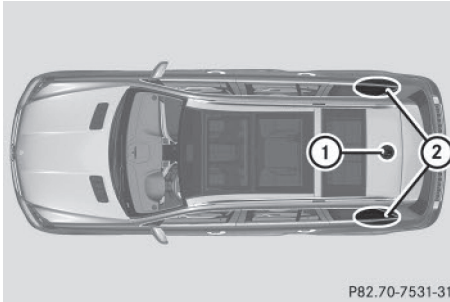

Approved antenna positions

- ① Rear roof area
- ② Rear fender

**i** On the rear fenders, it is recommended to position the antenna on the side of the vehicle closest to the center of the road.

Use the Technical Specification ISO/TS 21609 when retrofitting RF transmitters (Road Vehicles - EMC guidelines for installation of aftermarket radio frequency transmitting equipment). Observe the legal requirements for retrofittings.

If your vehicle has installations for two-way radio equipment, use the power supply or antenna connections intended for use with the basic wiring. Be sure to observe the manufacturer's additional instructions when installing.

Deviations with respect to wavebands, maximum transmission outputs or antenna positions must be approved by Mercedes-Benz.

The maximum transmission output (PEAK) at the base of the antenna must not exceed the following values:

Waveband	Maximum transmission output
Short wave 3 - 54 MHz	100 W
4 m waveband 74 - 88 MHz	30 W

Waveband	Maximum transmission output
2 m waveband 144 - 174 MHz	50 W
Trunked radio/Tetra 380 - 460 MHz	10 W
70 cm waveband 400 - 460 MHz	35 W
Mobile communications (2G/3G/4G)	10 W

The following can be used in the vehicle without restrictions:

- RF transmitters with a maximum transmission output of up to 100 mW
- RF transmitters with transmitter frequencies in the 380 - 410 MHz waveband and a maximum transmission output of up to 2 W (trunked radio/Tetra)
- Mobile telephones (2G/3G/4G)

There is no restriction for antenna positions on the outside of the vehicle for the following wavebands:

- Trunked radio/Tetra
- 70 cm waveband
- 2G/3G/4G

## Identification plates

### Vehicle identification plate with vehicle identification number (VIN)



- Open the driver's door.  
You will see vehicle identification plate ①.

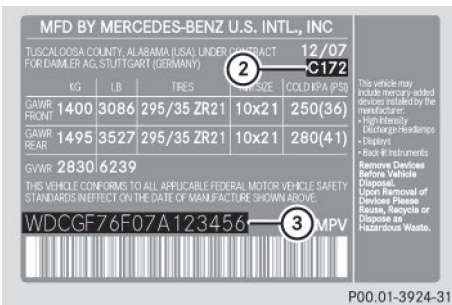

Example: vehicle identification plate (USA only)

- ② Paint code  
③ VIN

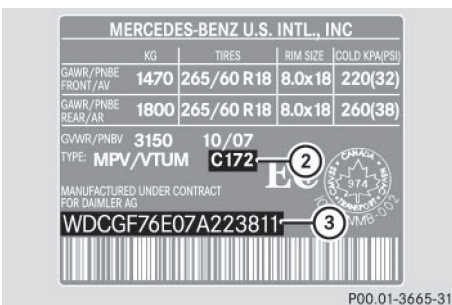

Example: vehicle identification plate (Canada only)

- ② Paint code  
③ VIN

- ① The data shown on the vehicle identification plate is used only as an example. This data is different for every vehicle and can deviate from the data shown here. You can find the data applicable to your vehicle on the vehicle identification plate.

### Vehicle identification number (VIN)

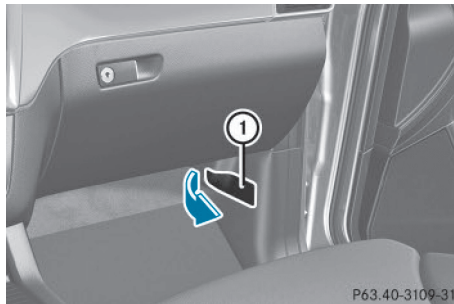

- Open the front right-hand door.  
► Open cover ① in the direction of the arrow and remove it.  
You will see the VIN.

The VIN can also be found in the following locations:

- on the lower edge of the windshield (▷ page 333)
- on the vehicle identification plate (▷ page 332)

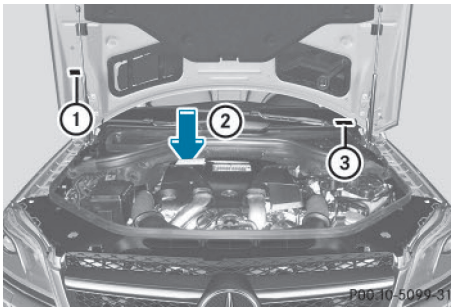
**Engine number**

- ① Emission control information plate, including the certification of both federal and Californian emissions standards
- ② Engine number (stamped into the crankcase)
- ③ VIN (on the lower edge of the windshield)

**Service products and filling capacities****Important safety notes****⚠ WARNING**

Service products may be poisonous and hazardous to health. There is a risk of injury.

Comply with instructions on the use, storage and disposal of service products on the labels of the respective original containers. Always store service products sealed in their original containers. Always keep service products out of the reach of children.

**♻ Environmental note**

Dispose of service products in an environmentally responsible manner.

Service products include the following:

- Fuels
- Exhaust gas aftertreatment additives, e.g. DEF
- Lubricants (e.g. engine oil, transmission oil)
- Coolant
- Brake fluid

- Windshield washer fluid
- Climate control system refrigerant

Components and service products must be matched. Only use products recommended by Mercedes-Benz. Damage which is caused by the use of products which have not been recommended is not covered by the Mercedes-Benz warranty or goodwill gestures. They are listed in this Mercedes-Benz Operator's Manual in the appropriate section.

Information on tested and approved products can be obtained at an authorized Mercedes-Benz Center or on the Internet at <http://bevo.mercedes-benz.com>.

You can recognize service products approved by Mercedes-Benz by the following inscription on the containers:

- MB-Freigabe (e.g. MB-Freigabe 229.51)
- MB Approval (e.g. MB Approval 229.51)

Other designations or recommendations indicate a level of quality or a specification in accordance with an MB Sheet Number (e.g. MB 229.5). They have not necessarily been approved by Mercedes-Benz.

Other identifications, for example:

- 0 W-30
- 5 W-30
- 5 W-40

**Fuel****Important safety notes****⚠ WARNING**

Fuel is highly flammable. If you handle fuel incorrectly, there is a risk of fire and explosion.

You must avoid fire, open flames, creating sparks and smoking. Switch off the engine and, if applicable, the auxiliary heating before refueling.

**⚠ WARNING**

Fuel is poisonous and hazardous to health. There is a risk of injury.

You must make sure that fuel does not come into contact with your skin, eyes or clothing and that it is not swallowed. Do not inhale fuel vapors. Keep fuel away from children.

If you or others come into contact with fuel, observe the following:

- Wash away fuel from skin immediately using soap and water.
- If fuel comes into contact with your eyes, immediately rinse them thoroughly with clean water. Seek medical assistance without delay.
- If fuel is swallowed, seek medical assistance without delay. Do not induce vomiting.
- Immediately change out of clothing which has come into contact with fuel.

**Tank capacity**

Model	Total capacity
All other models	26.4 US gal (100.0 l)

Model	Of which reserve
Mercedes-AMG vehicles	Approx. 3.7 US gal (14.0 l)
All other models	Approx. 3.2 US gal (12.0 l)

**Gasoline****Fuel grade**

**!** Do not use diesel to refuel vehicles with a gasoline engine. Do not switch on the ignition if you accidentally refuel with the

wrong fuel. Otherwise, the fuel will enter the fuel system. Even small amounts of the wrong fuel could result in damage to the fuel system and the engine. Notify a qualified specialist workshop and have the fuel tank and fuel lines drained completely.

- !** Only refuel using unleaded premium grade gasoline with at least 91 AKI/95 RON.
- !** Only use the fuel recommended. Operating the vehicle with other fuels can lead to engine failure.
- !** Do not use the following:
  - E85 (gasoline with 85% ethanol)
  - E100 (100% ethanol)
  - M15 (gasoline with 15% methanol)
  - M30 (gasoline with 30% methanol)
  - M85 (gasoline with 85% methanol)
  - M100 (100% methanol)
  - Gasoline with metalliferous additives
  - Diesel

Do not mix such fuels with the fuel recommended for your vehicle. Do not use additives. Otherwise, engine damage may occur. This does not include cleaning additives for the removal and prevention of residue build-up. Gasoline may only be mixed with cleaning additives recommended by Mercedes-Benz; see "Additives". You can obtain further information from any authorized Mercedes-Benz Center.

**!** To ensure the longevity and full performance of the engine, only premium-grade unleaded gasoline must be used.

If standard unleaded gasoline is unavailable and you have to refuel with unleaded gasoline of a lower grade, observe the following precautions:

- Only fill the fuel tank to half full with regular unleaded gasoline and fill the rest

with premium-grade unleaded gasoline as soon as possible.

- Do not drive at the maximum speed.
- Avoid sudden acceleration and engine speeds over 3,000 rpm.

You will usually find information about the fuel grade on the pump. If you cannot find the label on the pump, ask the staff for assistance.

**i** For further information, consult a qualified specialist workshop or visit <http://www.mbusa.com> (USA only).

**i** E10 fuel contains up to 10% bioethanol. Your vehicle is E10-compatible. You can refuel your vehicle using E10 fuel.

As a temporary measure, if the recommended fuel is not available, you may also use regular unleaded gasoline with an octane rating of 87 AKI/91 RON. This may reduce engine performance and increase fuel consumption. Avoid driving at full throttle and sudden acceleration. Never refuel using fuel with a lower AKI.

Information on refueling (▷ page 143).

### Additives

**!** Operating the engine with fuel additives added later can lead to engine failure. Do not mix fuel additives with fuel. This does not include additives for the removal and prevention of residue buildup. Gasoline must only be mixed with additives recommended by Mercedes-Benz. Comply with the instructions for use on the product label. More information about recommended additives can be obtained from any authorized Mercedes-Benz Center.

Mercedes-Benz recommends that you use branded fuels that have additives.

The quality of the fuel available in some countries may not be sufficient. Residue could build up in the injection system as a result. In such cases, and in consultation with an authorized Mercedes-Benz Center, the gasoline may be mixed with the cleaning additive

recommended by Mercedes-Benz. You must observe the notes and mixing ratios specified on the container.

### Diesel

#### Fuel grade

#### WARNING

If you mix diesel fuel with gasoline, the flash point is lower than that of pure diesel fuel. When the engine is running, exhaust system components could overheat without being noticed. There is a risk of fire.

Never refuel with gasoline. Never mix gasoline with diesel fuel.

**!** Only use Ultra Low Sulfur Diesel (ULSD), otherwise it may lead to increased wear and damage to the fuel system, engine and exhaust system.

**!** Do not use the following:

- gasoline
- diesel with a bio-diesel content greater than 5% (e.g. B20)
- bio-diesel
- vegetable oil
- paraffin
- kerosene
- marine diesel
- heating oil

Do not mix such fuels with diesel fuel and do not use any special additives. Otherwise, engine damage may occur.

**!** In countries outside USA and Canada, only use sulfur-free diesel with a sulfur content under 50 ppm. Otherwise, the emission control system could be damaged.

You will usually find information about the fuel grade on the pump. If you cannot find the label on the pump, ask the staff for assistance.

Information on refueling (▷ page 143).

### Low outside temperatures

- i** Diesel fuel with improved cold flow properties is available during the winter months. Further information about fuel properties can be obtained from oil companies, e.g. at gas stations.

## DEF

### Important safety notes

Comply with the important safety notes for service products when handling DEF (▷ page 333).

DEF is a water-soluble fluid for the exhaust gas aftertreatment of diesel engines. It is:

- not poisonous
- colorless and odorless
- not flammable

When you open the DEF container, small amounts of ammonia vapor may be released. Ammonia vapors have a pungent odor and are particularly irritating to the skin, to mucous membranes and to the eyes. You may experience a burning sensation in your eyes, nose and throat. Coughing and watering of the eyes are possible.

Do not inhale ammonia vapors. Fill the DEF tank only in well-ventilated areas.

### Low outside temperatures

DEF freezes at a temperature of approximately 12 °F (-11 °C). The vehicle is delivered from the factory equipped with a DEF pre-heating system. Winter operation can thus be guaranteed even at temperatures below 12 °F (-11 °C).

### Additives

- !** Only use DEF in accordance with ISO 2224 1. Do not use additives with DEF and do not dilute DEF with water. This may destroy the BlueTEC exhaust gas aftertreatment system.

### Purity

- !** Impurities in DEF (e.g. due to other service products, cleaning agents or dust) lead to:

- increased emission values
- damage to the catalytic converter
- engine damage
- malfunctions in the BlueTEC exhaust gas aftertreatment system

Assuring the purity of DEF is particularly important with respect to avoiding malfunctions in the BlueTEC exhaust gas aftertreatment system.

If DEF is pumped out of the DEF tank, e.g. during repair work, it must not be returned to the tank. The purity of the fluid can no longer be guaranteed.

### Filling capacities

Model	Total capacity
GL 350 Blue-TEC 4MATIC	8.8 US gal (33.4 l)

## Engine oil

### General notes

- !** Never use engine oil or an oil filter of a specification other than is necessary to fulfill the prescribed service intervals. Do not change the engine oil or oil filter in order to achieve longer replacement intervals than those prescribed. You could otherwise cause engine damage or damage to the exhaust gas aftertreatment.

Follow the instructions in the service interval display regarding the oil change. Otherwise, you may damage the engine and the exhaust gas aftertreatment.

When handling engine oil, observe the important safety notes on service products (▷ page 333).



The engine oils are matched to the performance of Mercedes-Benz engines and service intervals. You should therefore only use engine oils and oil filters that are approved for vehicles with maintenance systems.

For a list of approved engine oils and oil filters, consult an authorized Mercedes-Benz Center. Or visit the website <http://bevo.mercedes-benz.com>.

The table shows which engine oils have been approved for your vehicle.

Gasoline engines	MB Approval
All models	229.5

Diesel engines	MB Approval
GL 350 Blue-TEC 4MATIC	228.51, 229.31, 229.51, 229.52

**Mercedes-AMG vehicles:** use only SAE 0W-40 or SAE 5W-40 engine oils.

- MB approval is indicated on the oil containers.

### Filling capacities

The following values refer to an oil change including the oil filter.

Missing values were not available at time of going to print.

Model	Capacity
GL 350 Blue-TEC 4MATIC	8.5 US qt (8.0 l)
GL 450 GL 450 4MATIC	7.4 US qt (7.0 l)
GL 550 4MATIC	9.0 US qt (8.5 l)
Mercedes-AMG vehicles	

### Additives

- Do not use any additives in the engine oil. This could damage the engine.

### Engine oil viscosity

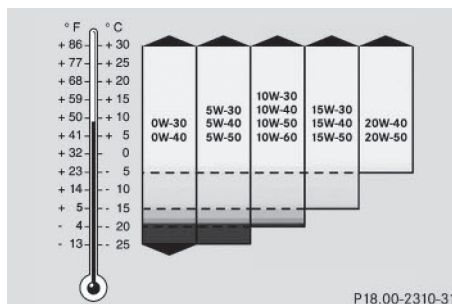

Viscosity describes the flow characteristics of a fluid. If an engine oil has a high viscosity, this means that it is thick; a low viscosity means that it is thin.

Select an engine oil with an SAE classification (viscosity) suitable for the prevailing outside temperatures. The table shows you which SAE classifications are to be used. The low-temperature characteristics of engine oils can deteriorate significantly, e.g. as a result of aging, soot and fuel deposits. It is therefore strongly recommended that you carry out regular oil changes using an approved engine oil with the appropriate SAE classification.

### Brake fluid

#### ⚠ WARNING

The brake fluid constantly absorbs moisture from the air. This lowers the boiling point of the brake fluid. If the boiling point of the brake fluid is too low, vapor pockets may form in the brake system when the brakes are applied hard. This would impair braking efficiency. There is a risk of an accident.

You should have the brake fluid renewed at the specified intervals.

Comply with the important safety notes for service products when handling brake fluid (▷ page 333).

The brake fluid change intervals can be found in the Maintenance Booklet.

Only use brake fluid approved by Mercedes-Benz according to MB Approval 331.0.

Information about approved brake fluid can be obtained at any qualified specialist workshop or on the Internet at <http://bevo.mercedes-benz.com>.

- i** Have the brake fluid regularly replaced at a qualified specialist workshop and the replacement confirmed in the Maintenance Booklet.

## Coolant

### Important safety notes

#### WARNING

If antifreeze comes into contact with hot components in the engine compartment, it may ignite. There is a risk of fire and injury.

Let the engine cool down before you add antifreeze. Make sure that antifreeze is not spilled next to the filler neck. Thoroughly clean the antifreeze from components before starting the engine.

- !** Only add coolant that has been premixed with the desired antifreeze protection. You could otherwise damage the engine.

Further information on coolants can be found in the Mercedes-Benz Specifications for Service Products, MB BeVo 310.1, e.g. on the Internet at

<http://bevo.mercedes-benz.com>. Or contact a qualified specialist workshop.

- !** Always use a suitable coolant mixture, even in countries where high temperatures prevail.

Otherwise, the engine cooling system is not sufficiently protected from corrosion and overheating.

- i** Have the coolant regularly replaced at a qualified specialist workshop and the replacement confirmed in the Maintenance Booklet.

Comply with the important safety precautions for service products when handling coolant (▷ page 333).

The coolant is a mixture of water and anti-freeze/corrosion inhibitor. It performs the following tasks:

- corrosion protection
- antifreeze protection
- raising the boiling point

If the coolant has antifreeze protection down to -35 °F (-37 °C), the boiling point of the coolant during operation is approximately 266 °F (130 °C).

The antifreeze/corrosion inhibitor concentration in the engine cooling system should:

- be at least 50%. This will protect the engine cooling system against freezing down to approximately -35 °F (-37 °C).
- not exceed 55% (antifreeze protection down to -49 °F [-45 °C]). Otherwise, heat will not be dissipated as effectively.

Mercedes-Benz recommends an antifreeze/corrosion inhibitor concentrate in accordance with MB Specifications for Service Products 310.1.

- i** When the vehicle is first delivered, it is filled with a coolant mixture that ensures adequate antifreeze and corrosion protection.

- i** The coolant is checked with every maintenance interval at a qualified specialist workshop.

### Filling capacities

Model	Capacity
GL 350 Blue-TEC 4MATIC	Approx. 12.2 US qt (11.5 l)
GL 450 GL 450 4MATIC	Approx. 10.3 US qt (9.7 l)
GL 550 4MATIC	Approx. 12.0 US qt (11.4 l)
Mercedes-AMG vehicles	Approx. 13.1 US qt (12.4 l)

### Windshield washer system

#### Important safety notes

##### WARNING

Windshield washer concentrate could ignite if it comes into contact with hot engine components or the exhaust system. There is a risk of fire and injury.

Make sure that no windshield washer concentrate is spilled next to the filler neck.

**!** Do not add distilled or de-ionized water to the washer fluid container. Otherwise, the level sensor may be damaged.

**!** Only MB SummerFit and MB WinterFit washer fluid should be mixed together. The spray nozzles may otherwise become blocked.

When handling washer fluid, observe the important safety notes on service products (▷ page 333).

At temperatures above freezing:

- ▶ Fill the washer fluid reservoir with a mixture of water and windshield washer fluid, e.g. MB SummerFit.

Add 1 part MB SummerFit to 100 parts water.

At temperatures below freezing:

- ▶ Fill the washer fluid reservoir with a mixture of water and washer fluid, e.g. MB WinterFit.

For the correct mixing ratio refer to the information on the antifreeze reservoir.

- i** Add windshield washer fluid, e.g. MB SummerFit or MB WinterFit, to the washer fluid all year round.

### Climate control system refrigerant

#### Important safety notes

The climate control system of your vehicle is filled with refrigerant R-134a.

The instruction label regarding the refrigerant type used can be found on the radiator cross member.

**!** Only the refrigerant R-134a and the PAG oil approved by Mercedes-Benz may be used. The approved PAG oil may not be mixed with any other PAG oil that is not approved for R-134a refrigerant. Otherwise, the climate control system may be damaged.

Service work, such as topping up refrigerant or replacing components, may only be carried out by a qualified specialist workshop. All applicable regulations must be adhered to, SAE standard J639 included.

Always have work on the climate control system carried out at a qualified specialist workshop.

### Refrigerant instruction label

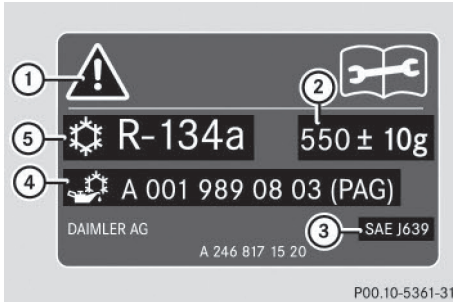

Example: refrigerant instruction label

- ① Warning symbol
- ② Refrigerant filling capacity
- ③ Applicable standards
- ④ PAG oil part number
- ⑤ Type of refrigerant

Warning symbol ① advises you about:

- possible dangers
- having service work carried out at a qualified specialist workshop

### Filling capacities

Missing values were not available at time of going to print.

Mercedes-AMG vehicles	Capacity
Refrigerant	
PAG oil	

All other models	Capacity
Refrigerant	37.0 ± 0.4 oz (1050 ± 10 g)
PAG oil	3.9 ± 0.4 oz (110 ± 10 g)

### Vehicle data

#### General notes

Please note that for the specified vehicle data:

- the heights specified may vary as a result of:
  - tires
  - load
  - condition of the suspension
  - optional equipment
- optional equipment reduces the maximum payload.

#### Dimensions and weights

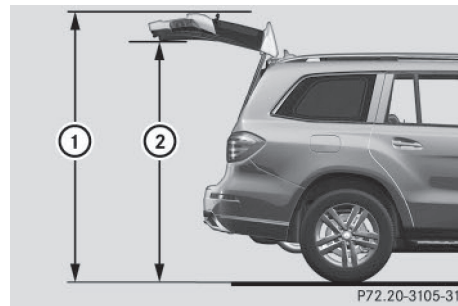

Model	① Opening height	② Max. headroom
Mercedes-AMG vehicles	84.1 in - 86.6 in (2136 mm - 2199 mm)	78.8 in (2002 mm)

All other models with:	① Opening height	② Max. headroom
<b>AIRMATIC package</b>	83.9 in - 86.9 in (2132 mm - 2207 mm)	76.1 in - 79.1 in (1934 mm - 2009 mm)
<b>ON&amp;OFF-ROAD package</b>	83.9 in - 88.1 in (2132 mm - 2237 mm)	76.1 in - 80.3 in (1934 mm - 2039 mm)

Mercedes-AMG vehicles	
<b>Vehicle length</b>	202.6 in (5146 mm)
<b>Vehicle width including exterior mirrors</b>	84.3 in (2141 mm)
<b>Vehicle width without exterior mirrors</b>	78.0 in (1982 mm)
<b>Maximum vehicle height</b>	74.9 in (1902 mm)
<b>Minimum vehicle height</b>	72.4 in (1839 mm)
<b>Wheelbase</b>	121.1 in (3075 mm)
<b>Maximum ground clearance</b>	9.8 in (249 mm)
<b>Minimum ground clearance</b>	7.4 in (188 mm)
<b>Turning radius</b>	40.8 ft (12.45 m)
<b>Maximum roof load</b>	220 lb (100 kg)

All other models	
<b>Vehicle length</b>	202.0 in (5130 mm)
<b>Vehicle width including exterior mirrors</b>	84.3 in (2141 mm)
<b>Maximum vehicle height (ON&amp;OFFROAD package)</b>	76.4 in (1940 mm)
<b>Minimum vehicle height (highway driving level)</b>	72.8 in (1850 mm)
<b>Wheelbase</b>	121.1 in (3075 mm)
<b>Maximum ground clearance (ON&amp;OFFROAD package)</b>	12.0 in (306 mm)
<b>Minimum ground clearance</b>	7.9 in (201 mm)
<b>Turning radius</b>	40.7 ft (12.40 m)
<b>Maximum roof load</b>	220 lb (100 kg)

Vehicle data for off-road driving

Fording depth



① Fording depth

Missing values were not available at the time of going to print.

	Fording depth
<b>Vehicles without the ON&amp;OFFROAD package</b>	
Raised level	20 in (50 cm)
<b>Vehicles with the ON&amp;OFFROAD package</b>	
Off-road level 1	20 in (50 cm)
Off-road level 2	20 in (50 cm)
Off-road level 3	23.6 in (60 cm)
<b>Mercedes-AMG vehicles</b>	20 in (50 cm)

For more information about off-road fording, see the Digital Operator's Manual.

## Technical data

### Approach/departure angle

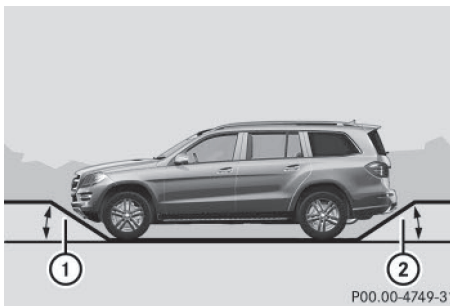

All vehicles (except vehicles with AMG bodystyling)

	①	②
<b>Vehicles without the ON&amp;OFFROAD package</b>		
Normal level	25°	20°
Raised level	30°	25°

	①	②
<b>Vehicles with the ON&amp;OFFROAD package</b>		
Normal level	25°	20°
Off-road level 1	28°	23°
Off-road level 2	30°	25°
Off-road level 3	33°	27°
<b>Mercedes-AMG vehicles</b>		
Normal level (in sport mode with AMG adaptive sport suspension system activated)	19°	19°
Raised level	23°	22°

### Vehicles with AMG bodystyling

	①	②
<b>Vehicles without the ON&amp;OFFROAD package</b>		
Normal level	20°	20°
Raised level	24°	24°
<b>Vehicles with the ON&amp;OFFROAD package</b>		
Normal level	20°	20°
Off-road level 1	22°	22°
Off-road level 2	24°	24°
Off-road level 3	26°	26°

For further information about approach/departure angles, see the Digital Operator's Manual.

### Maximum gradient-climbing capability

Note that the vehicle's gradient-climbing capability depends on the off-road conditions and the road surface conditions.

**Vehicles with the ON&OFFROAD package:** the maximum gradient climbing ability is 100% when the LOW RANGE off-road gear is selected.

**Vehicles without the ON&OFFROAD package:** the maximum gradient climbing ability is 80%.

Accelerate carefully and make sure that the wheels do not spin when driving on steep terrain.

- ① If the load on the front axle is reduced when pulling away on a steep uphill slope, the front wheels have a tendency to spin. 4ETS recognizes this and brakes the wheels accordingly. The rear wheel torque is increased, making it easier to drive off.

For further information about maximum gradient-climbing capability, see the Digital Operator's Manual.

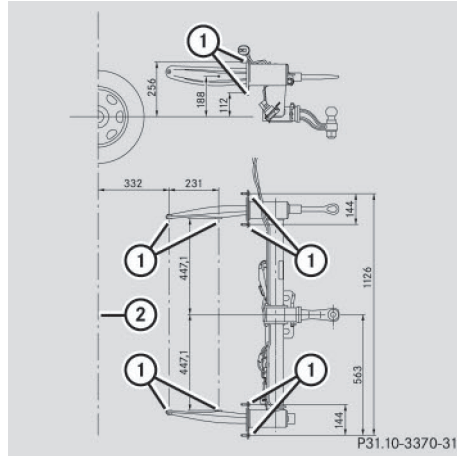

- ① Anchorage points for the trailer tow hitch
- ② Rear axle center line

### Trailer tow hitch

#### Mounting dimensions

- ⚠ If you have a trailer tow hitch retrofitted, changes to the cooling system and drive train may be necessary, depending on the vehicle type.

If you have a trailer tow hitch retrofitted, observe the anchorage points on the chassis frame.



### Trailer loads

#### Trailer loads, trailer drawbar noseweights and axle loads

Missing values were not available at time of going to print.

	GL 450
Permissible trailer load, unbraked	
Permissible trailer load, braked (at a minimum gradient-climbing capability of 12% from a standstill)	6613 lbs (3000 kg)
Maximum drawbar noseweight (the drawbar noseweight is not included in the trailer load)	529 lbs (240 kg)
Permissible rear axle load when towing a trailer	3970 lbs (1800 kg)

	GL 450 4MATIC, GL 550 4MATIC and GL 350 Blue-TEC 4MATIC
Permissible trailer load, unbraked	
Permissible trailer load, braked (at a minimum gradient-climbing capability of 12% from a standstill)	7500 lbs (3402 kg)
Maximum drawbar noseweight (the drawbar noseweight is not included in the trailer load)	600 lbs (272 kg)
Permissible rear axle load when towing a trailer	3970 lbs (1800 kg)

	GL 63 AMG 4MATIC
Permissible trailer load, unbraked	
Permissible trailer load, braked (at a minimum gradient-climbing capability of 12% from a standstill)	7165 lbs (3250 kg)
Maximum drawbar noseweight (the drawbar noseweight is not included in the trailer load)	309 lbs (140 kg)
Permissible rear axle load when towing a trailer	4189 lbs (1900 kg)

The actual noseweight may not be higher than the value which is given. The value can be found on the trailer tow hitch or trailer identification plates. The lowest weight applies.

The maximum permissible trailer drawbar noseweight is the maximum weight with which the trailer drawbar can be loaded. Limit for Mercedes-Benz-approved trailer couplings.

### Ball position of the ball coupling

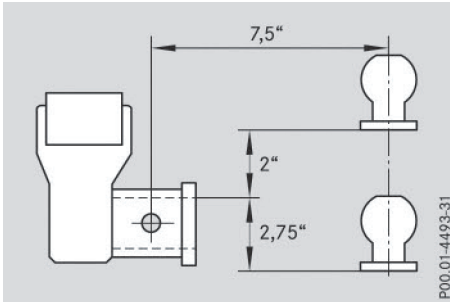

When choosing a ball coupling, the dimensions stated in the illustration must not be exceeded.





